

Laminate Modular Desking, Tables + Metal Filing

Effective January 2017

Revised March 2017



PRICE LIST
desking + tables



think global

THE GLOBAL EDGE

ERGONOMICS IN THE TOTAL OFFICE

- One stop shopping for a full range of office furniture.
- Seating, desks, tables, files, modular furniture, panels and accessories.
- Ergonomics, competitive pricing and built-in value.

STRENGTH AND STABILITY

- Established in 1966.
- One of North America's largest office furniture manufacturers.
- Manufacturing and showrooms worldwide.

QUICK SHIP - INSTOCK

- Hundreds of products in stock for immediate delivery.

STRONG LOCAL REPRESENTATION

- Service and expert advice where you are, when you need it!

MANUFACTURING CAPABILITY

- Vertical integration ensures "start to finish" control.
- Ongoing research and investment in new, innovative production technology.

QUALITY ASSURANCE

- Quality Assurance Program is qualified by C.G.S.B. ISO9001 standards.
- On-site furniture testing facility.
- Product and components are tested to ANSI/BIFMA standards.

ENVIRONMENTAL COMMITMENT

- Continuous development of "earth friendly" programs.
- One of the first molded foam manufacturers to create ozone-friendly, CFC and HFC-free processes.
- Seat and back pans are made from recyclable plastics and wood waste, enabling little waste and cost effective products.

SYMBOL IDENTIFICATION



Global's Certified Products are in compliance with the stringent emission guidelines set by the GREENGUARD Environmental Institute and include all Upholstered Seating. To obtain a GREENGUARD Certificate for any product, please go to the product page on our website www.globalfurnituregroup.com and click on "View GREENGUARD Certificate".



level™ certification, based on the ANSI/BIFMA e3-2012 furniture sustainability standard, sets furniture manufacturers on a path toward greater sustainability over time. Based on environmental and social criteria set forth in the standard, a product's entire supply chain is assessed.



Certification assessment includes an evaluation of specific corporate policies and guidelines and an assessment of associated company manufacturing facilities. Products must meet quantifiable milestones of environmental and social performance at every step of development.

The quantitative assessment addresses four categories: material use, energy and atmosphere impacts, human and ecosystem health and social responsibility.

Manufacturers earn points in each of the four categories. The level™ brand and its numeric rating of 1, 2 or 3 indicate what threshold of certification a product has achieved. level™ 3 is the highest rating.

TABLE OF CONTENTS

LAMINATE DESKS

Adaptabilities.....	9-47
Consumer Education	6
Correlation.....	48-85
Desk Accessories.....	514-515
Desking Comparison Chart.....	4-5
Genoa	86-97
Halton.....	98-104
Laminate Desk Notes.....	8
Princeton	105-162
Zira	163-283
Zira Boardroom & Reception.....	284-305

METAL DESKS

StreamLINE	306-337
------------------	---------

BENCHING

Bridges II	338-393
Sidebar.....	394-445

PANELS AND COMPONENTS

Divide	478-499
eO+ Panels	446-477
GPS II.....	491-498

PRODUCTIVITY SOLUTIONS by Global

Productivity Solutions	500-519
CPU Holders / Laptop Stands.....	509-510
FOLI Height Adjustable Tables.....	502-504
Keyboard Mechanisms.....	508-509
Keyboard Trays.....	507-508
Manual Height Adjustable Tables	501
Monitor Arms.....	504-506
Office Accessories.....	514-517
Power/Data	511-514

TABLES - MEETING + CONFERENCE

Zgether Tables.....	534-535
Alba Tables.....	536-547
Boardroom Tables	548-585
Bungee Tables	575-585
Bungee SL Tables.....	586-599
Power/Data Management Troughs.....	594-599
ConnectTABLES.....	600-615
Junction Tables	616-623
Nutcracker.....	623-630
Swap Tables.....	631-643
Zira Boardroom Tables	284-296

TABLE OF CONTENTS

TABLES - RECEPTION & OCCASIONAL

Citi Tables.....	644
Coat Trees	645
Coffee/End Tables.....	645
Dawson Tables.....	646
Folding Tables.....	647
Laminate Occasional Tables	648-649
Lite Lift II Folding Tables.....	650
Reception Tables.....	651-652
Rectangular Tables.....	652
Sirena Tables.....	653
Table Dolly.....	648
Wind Tables	654-656

TABLE POWER & TECHNOLOGY SOLUTIONS

Table Power & Technology Solutions	520-532
--	---------

FILES + STORAGE

Blocks.....	725-730
File Buddy.....	701
File Taxi	715
Lateral Files.....	670-698
Lateral File Accessories.....	699-700
Lateral File Tops.....	700-701
Metal Bookshelves.....	716-718





FILES + STORAGE (cont'd)

Pedestals.....	663-669
Personal Towers/Wardrobes	702-705
Storage Cabinets.....	706-714
Vertical Files.....	719-724





REFERENCE

Custom Grommet Location Form.....	739
Terms/Conditions/Warranty.....	740-743
Textiles & Finishes.....	731-739

DESKING COMPARISON CHART

	ADAPTABILITIES	BRIDGES II	CORRELATION	GENOA
				
GENERAL FEATURES	Top Over End Panel Design 400 Color Combinations Virtually No Loose Hardware Storage Height is 66" 2 Handle Options	Beam-Based Benching System 20+ Finishes Available 8-Wire, 4-Circuit Electrical Storage Height is 21", 25" and 29"	Top Over End Panel Design 400 Color Combinations Virtually No Loose Hardware Storage Height is 72" 6 Handle Options	Top Over End Panel Design 3/4 Pedestal Standard Virtually No Loose Hardware Storage Height is 66"
GOOD BETTER BEST	Better	Best	Better	Good
STYLE	Transitional	Contemporary	Transitional	Transitional
PRICE POINT (36x72 Double Pedestal Desk)	\$1,318	N/A	\$1,532	\$973
WORKSURFACE THICKNESS	1"	1"	1.5"	1"
SURFACE TYPE	High Performance Thermally Fused Laminate or HPL	High Performance Thermally Fused Laminate or HPL	High Performance Thermally Fused Laminate or HPL	High Performance Thermally Fused Laminate
EDGE THICKNESS	2mm	3mm	2mm	Self Edge
EDGE OPTIONS	Flat	N/A	Flat or Fluted	N/A
HUTCH CLEARANCE (Worksurface to underside of hutch)	17.75" to Valance 20" to Underside of Hutch	N/A	23.75" to Valance 26" to Underside of Hutch	20"
GREENGUARD CERTIFIED	Yes	Yes	Yes	Yes
BIFMA e3 LEVEL CERTIFIED	Level 3	Level 2	Level 3	Level 3
USDA BIO-PREFERRED EDGING	Yes	No	Yes	Yes

DESKING COMPARISON CHART

	HALTON	PRINCETON	STREAMLINE	ZIRA
				
GENERAL FEATURES	<p>Top Over End Panel Design</p> <p>3/4 Pedestal Standard</p> <p>Virtually No Loose Hardware</p>	<p>Freestanding, modular components</p> <p>Overlapping architectural elements</p> <p>13 standard finishes; up to 3 color application on many components available</p> <p>Optional 6mm tempered glass on hutches and desktop storage.</p> <p>Storage Height is 52" and 66"</p>	<p>Laminate Top over Steel End Panel / Storage Design.</p> <p>All Global Laminates available on top.</p> <p>Standard, Paints, Textured and Custom Paint Colors available on steel chassis.</p>	<p>Top Over End Panel Design</p> <p>400 Color Combinations</p> <p>Virtually No Loose Hardware</p> <p>Storage Height is 42", 54", 66", 72" and 84" (nominal).</p> <p>9 Handle Options</p> <p>4 Glazing Options for storage doors and modesty panels.</p>
GOOD BETTER BEST	Good	Best	Better	Best
STYLE	Transitional	Contemporary	Contemporary	Contemporary
PRICE POINT (36x72 Double Pedestal Desk)	\$1,085	N/A	\$1,722	\$1,773
WORKSURFACE THICKNESS	1"	1"	1"	1" or 1.5"
SURFACE TYPE	High Performance Thermally Fused Laminate	High Performance Thermally Fused Laminate or HPL	High Performance Thermally Fused Laminate or HPL (upcharge)	High Performance Thermally Fused Laminate or HPL
EDGE THICKNESS	2mm	2mm	2mm	2mm
EDGE OPTIONS	N/A	N/A	N/A	Flat, Fluted or Bicut
HUTCH CLEARANCE (Worksurface to underside of hutch)	N/A	15.75"	24"	20.25" (23.5" Hutch) 17.75" (36" Hutch) 24.25" (42" Hutch) 24.25" (54" Hutch)
GREENGUARD CERTIFIED	Yes	Yes	Yes	Yes
BIFMA e3 LEVEL CERTIFIED	Level 3	Level 2	Level 2	Level 3
USDA BIO-PREFERRED EDGING	Yes	No	No	Yes

CONSUMER EDUCATION

How do I buy a desk?



Choose a non-reflective surface. Global uses colors that reduce glare to make your work easier to read while reducing eye strain.



Get a desk that lets you look ahead. A modular desk is easy to set up initially and then reorganize or reconfigure later to adapt to future needs.

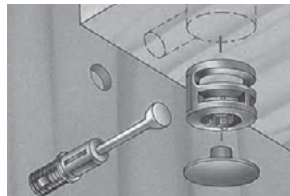

Look for European connectors if you're buying ready-to-assemble furniture. Global makes assembly easy - all you need is a screwdriver.



Give your business an edge. Each Global desk comes with its own attractive edge design.



Avoid tangles. Make sure your desk has at least one grommet hole to keep computer and telephone wires out of the way.

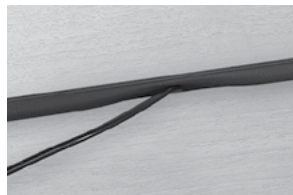

A hutch should have a sweep that manages computer and telephone wires.



Island workspaces let you meet with more than two people at once with ample leg room for all.

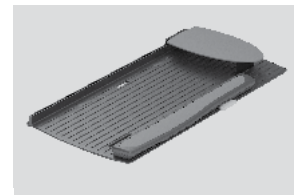

Choose one of Global's height/angle adjustable keyboard trays to go with your desk. Your arms can maintain a comfortable position, reducing shoulder, back and neck strain.

How do I select the right workstation?

When searching for the right workstation it is important to consider its purpose which will be decided by the nature of your tasks. It is best to look for products that have been designed and engineered to help make your workspace more productive.

This can be achieved in a variety of ways. As a guide, observe how your work flows through your office in a typical day. It is likely that you'll uncover a number of distinctive and repetitive task patterns.

Once these patterns have been identified, organize them according to their intended use and frequency of their use. Now you are ready to investigate the pertinent factors that will determine the workspace you eventually select.

Lighting - Protect yourself

- If you have to setup near a window make sure your computer sits perpendicular to it, minimize eye-strain inducing glare on sunny days.
- If you have fluorescent lights, try to position your set up between the lights.
- Use "Parabolic louvers" to reduce the glare from fluorescent lights
- Use window blinds to control the light source through the day
- Panels or screens may be used to control glare
- Protect your eyes from Ultraviolet A (UVA) and Ultraviolet B (UVB) by using an anti-glare screen

Noise

- Try to set up your office in a separate room if possible and away from the rest of the house

Chair

- Comfort is personal but should be part of the selection
- Seat pan design; deep and wide enough
- Rounded front edge (waterfall)
- Adjustable slope seat
- Able to adjust your chair, to obtain appropriate height
- Sit back in your chair, with your thighs parallel to the floor
- Place feet flat on the floor, a footlocker may be required

Footlocker

- A footlocker helps to prevent possible discomfort resulting from outstretched feet
- The rocking motion creates light activity in the legs and feet and will help stimulate muscles to improve overall circulation

Keyboard

- Has a palm rest
- Easily adjusts the angle of the keyboard
- Easily adjusts the keyboard height

Document Holder

- A curved back document holder reduces glare
- Position document holder in line with the monitor to reduce eyestrain

Monitor

- There should be a direct line from the center of monitor to the, "J" key on your keyboard which should line up with your belt buckle
- Position the monitor at arm's length
- Make sure that the top of your monitor screen is slightly below eye level
- A monitor stand may be used to achieve the desired height

Workstation

- Adequate space beneath the worksurface for your legs
- Depth of the worksurface depends on the task and equipment used to perform this responsibility
- Try to place tasks that are performed regularly within arm's reach
- Avoid unnecessary reaching and bending which leads to fatigue and possible muscle strains and can reduce efficiency
- Keep in mind other related tasks in your planning
- Establish your workflow then design the essential elements to meet your requirements

desking – laminate



Adaptabilities

9



Correlation

48



Genoa

86



Halton

98



Princeton

105



Zira

163

LAMINATE DESK NOTES

The following applies to all series EXCEPT the Bridges II, Princeton and StreamLINE series.

For information on the Bridges II series, please refer to page 338, for the Princeton series, please refer to page 105 and for the Streamline II series, please refer to page 306.

- Outside and surface panels are made from 1" thick 45 lb. density particle board and covered on both sides with high performance thermally fused laminate. Modesty panels are 11/16" thick.
- **BOX AND FILE DRAWERS** use FULL EXTENSION STEEL BALL BEARING SLIDES for smooth action.
- **BOX AND FILE PEDESTALS** are standard and are CONSTRUCTED INDEPENDENTLY of the chassis, with fully closed bottoms. This PICTURE FRAME CONSTRUCTION technique prevents racking, and provides a product that lasts for years.
- **FILE DRAWERS** file both legal and letter documents as standard (LETTER FILES will file in BOTH DIRECTIONS, as will LATERAL FILES), except 15"w Zira units (side to side only).
- Drawers and END PANELS are **EDGE BANDED** on ALL FOUR SIDES to protect clothing and the floor covering.
- Locks are standard on all box and file pedestals, lateral files, storage cabinets and combination storage units.
- All locking components within each series can be keyed alike at no additional charge. Please specify the request at time of ordering.
- Drawers are opened with side pulls and are constructed 22" deep (Genoa and Halton 18"D) using French dovetail joints at the front and lap joints at the rear. Woodgrain enameled bottoms are routed into the woodgrain (MDF) sides on three edges.
- Full to the floor pedestal configurations can be switched for a **15% upcharge** (Adaptabilities, Correlation and Halton series ONLY).
- Pencil tray included with each desk.
- **LEVELING GLIDES** are standard on ALL UNITS.
- All units are **shipped fully assembled** (except where noted) on 1" x 3" thick wood furniture skids with pedestal supports inside high quality cartons.
- **ALL "L" SHAPED DESKS** have flush backs on the return (modesty panels).
- Additional options available include (add suffix to item number):
FM = Full modesty panel. Available on any desk or credenza. **ADD \$51.** (Standard on Adaptabilities, Correlation & Zira Series).
- Desks with FULL TO FLOOR pedestals CANNOT have ¾ modesty panels.
- Corners must have matching modesty panels (both sides must be either ¾ or full modesty panels).
- **Modesty panels** on CORNERS will be 1" above the floor; **Modesty panels** on RETURNS are flush with the floor. It is recommended that corner units are used for corner spaces when configuring workstations so there is no visible difference if a corner is connected to a return.
- Optional grommets are available. **SEE EACH SERIES** for details. **ADD \$65.**
- Global Furniture Group will consider custom, specials and product alterations on an individual basis.
- Desk series can only be made in **Standard Global Laminates**.
- **PLEASE REFER TO SERIES FOR FINISHES AVAILABLE.** The following desk finishes are offered:

WOODGRAINS:

Absolute Acajou (ACJ)	Asian Night (ASN)	Avant Cherry (AWC)
Avant Honey (AWH)	Dark Espresso (DES)	Quartered Mahogany (QTM)
Shaker Cherry (SKC)	Tiger Fruitwood (TFW)	Tiger Mahogany (TMA)
Tiger Maple (TMP)	Tiger Walnut (TWL)	White Chocolate (WHC)
Winter Cherry (WCR)		

SOLIDS:

Grey (GRY)	Willow Grey (WGY)	White (WHT)
Storm Grey (SOG)	Black (BLK)	Hayden Grey (HGT)

PATTERNS:

Brushed Cobalt (BRC)	Constellation Java (CSJ)
----------------------	--------------------------

- See **Productivity Solutions** and **Desk Accessories** for additional options



With over 370 components available in 400 color combinations, Adaptabilities provides the ultimate in flexibility and modularity. Rich laminate colors coordinate easily with any office or home decor. All surfaces are constructed from Global's exclusive premium grade, high performance laminate and preferred matching edges.

Adaptabilities features an extensive range of versatile components which can be configured into multi-user workstations suitable for intensive task functions, or for private executive suites requiring stately elegance and work-force functions. All laminate filing cabinets have a safety mechanism that prevents two drawers from being opened at the same time. File drawers have fully progressive ball bearing suspensions and accommodate letter and legal filing. For heavy duty usage, two, three and four drawer laminate files are available with steel drawer interiors.



Features and Benefits

- 45lb. density particle board substructure with high performance thermally fused laminate
- 1" thick worksurfaces in thermally fused or high pressure laminate
- Worksurfaces feature 2mm edging in matching color.
- Full to floor or ¾ pedestals available on most components
- All desks are size (incrementally) accurate
- 11/16" thick full modesty panel is standard
- 11/16" thick 3/4 modesty panel is available on most components
- 75lb. box - 150 lb. file drawer weight capacity with full height sides, plus pencil tray included in box drawer
- File drawers can accommodate legal or letter documents
- Full progressive ball bearing suspension on file drawers
- All drawer fronts edge banded with side pull opening pedestals and standard with pedestal locks
- Compatible with **Divide** panel system for increased privacy and storage requirements

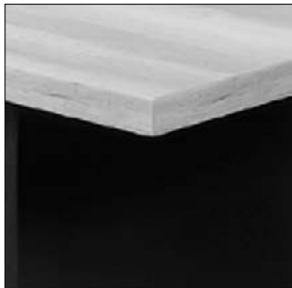

Tops are 1" thick and a top over side, edge panel design.



¾ modesty panel available at no extra charge.



For heavy duty usage, two, three and four drawer laminate files are available with steel drawer interiors.

GENERAL INFORMATION

- Constructed of 45 lb. density particleboard with high performance thermally fused laminate
- Adaptabilities transaction tops available for use on GPS II panels around Adaptabilities installations. See pages 383-390 for product specifications and prices.
- Adaptabilities components are compatible with Divide transaction tops and partitioning panels. See pages 370-382 for Divide specifications and prices.
- See pages 40-41 for keyboard drawers and additional accessory options.
- Adaptabilities desk and storage products have been tested and comply with all BIFMA mechanical tests.
- GREENGUARD INDOOR AIR QUALITY CERTIFICATION - Global laminate and seating products are in compliance with stringent emission guidelines set out by the Greenguard Environmental Institute under the standards for low emitting products and materials. www.greenguard.org.
- **Level 3 Certified**

WORKSURFACES

- 1" thick high performance thermally fused laminate tops sealed with Global's Preferred edging in matching color
- Woodgrain surfaces feature edging with matching printed woodgrain
- High Pressure Tops are available in all Adaptabilities laminate finishes at an extended lead time. Please see model # for pricing and availability

CONSTRUCTION

- Constructed of 45 lb. density particleboard with high performance thermally fused laminate.
- Cabinets and Wardrobes are 65" high to match overall height of a worksurface with hutch (worksurface 29" + hutch 36" = 65").
- End Shelves are available as 65" high also to match overall height.
- Models with monoposts are standard with a Black monopost; Silver is available at no charge, please specify as **SI**. The Silver finish will match the Silver finish used on Divide.
- Models with handles are standard with a Black handle; Silver is available at no charge, please specify as **SI**. The Silver finish will match the Silver finish used on Divide.
- All drawer fronts edge banded with side pull opening pedestals and standard pedestal locks
- Double wall pedestal housing with fully closed bottom

MODESTY PANELS

- 11/16" thick full modesty panel is standard
- 11/16" thick ¾ modesty panel available on most components
- ¾ height modesty panels available on most models at no additional charge. Please specify "**3MP**". (Corners must have both modesty panels as ¾ or full).
- **Note:** Woodgrain modesty panels over 60" wide will have the grain pattern in the horizontal direction. All end panels and modesty panels 60" or less will have the grain pattern in the vertical direction.

STORAGE

- All lateral file drawer fronts feature the woodgrain running in a horizontal direction.
- 75 lb box - 150 lb. file drawer weight capacity with full height sides with pencil tray included in box drawer
- File drawers can accommodate legal or letter documents
- Triple progressive ball bearing suspension on file drawers

LOCKS

- Optional locks available for all straight hutch unit doors. Add **\$95** each lock
- Front-to-back filing bars for all steel drawer files available separately. Order FBB file bars. [See page 565 for pricing.](#)

SPECIAL SIZES

- Additional custom sized components available upon request.
- Customer specified printer slots available in all worksurfaces. Contact Global Customer Service for pricing.
- Secretarial height returns (26 ½") available at a 15% upcharge.
- Full to the floor pedestal configurations can be switched for a 15% upcharge.

1. SPECIFY MODEL NUMBER

2. SPECIFY FINISH

One Tone Finishes:

ACJ	Absolute Acajou
ASN	Asian Night
AWC	Avant Cherry
AWH	Avant Honey
BLK	Black
BRC	Brushed Cobalt
CSJ	Constellation Java
DES	Dark Espresso
HGT	Hayden Grey
QTM	Quartered Mahogany
SKC	Shaker Cherry
SOG	Storm Grey
TFW	Tiger Fruitwood
TMA	Tiger Mahogany
TMP	Tiger Maple
TWL	Tiger Walnut
WHT	White
WHC	White Chocolate*
WGY	Willow Grey
WCR	Winter Cherry

Top Finishes:

ACJ	Absolute Acajou
ASN	Asian Night
AWC	Avant Cherry
AWH	Avant Honey
BLK	Black
BRC	Brushed Cobalt
CSJ	Constellation Java
DES	Dark Espresso
HGT	Hayden Grey
QTM	Quartered Mahogany
SKC	Shaker Cherry
SOG	Storm Grey
TFW	Tiger Fruitwood
TMA	Tiger Mahogany
TMP	Tiger Maple
TWL	Tiger Walnut
WHT	White
WHC	White Chocolate*
WGY	Willow Grey
WCR	Winter Cherry

*textured, HP non textured, top only

Body Finishes (including pedestals):

ACJ	Absolute Acajou
ASN	Asian Night
AWC	Avant Cherry
AWH	Avant Honey
BLK	Black
BRC	Brushed Cobalt
CSJ	Constellation Java
DES	Dark Espresso
HGT	Hayden Grey
QTM	Quartered Mahogany
SKC	Shaker Cherry
SOG	Storm Grey
TFW	Tiger Fruitwood
TMA	Tiger Mahogany
TMP	Tiger Maple
TWL	Tiger Walnut
WHT	White
WHC	White Chocolate*
WGY	Willow Grey
WCR	Winter Cherry

3. SPECIFY OPTIONS

Grommets

- Additional grommets available in standard worksurface locations (left, center or right).
- Order as: **AG1, AG2 or AG3.....Add \$65**

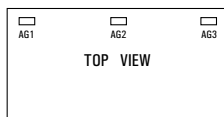

- Grommet hole dimensions are 3 1/4" wide x 1 7/8" deep.
- Actual grommet locations on the worksurface are depicted in the example drawings shown below. Dimensions shown are actual measurements (in inches).

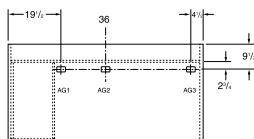

36 x 72 single pedestal left desks (A3672SPL)

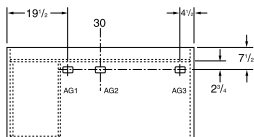

30 x 60 single pedestal left desks (A3060SPL)

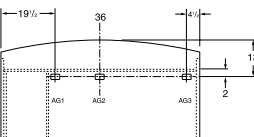

36 x 72 single pedestal left bow top desks (A3672SLB)

- Grommets may be placed at non-standard locations. Order as: **AGS - Add \$65**. A drawing must be supplied with vertical and horizontal dimensions to the center of the cut-out (as in drawing above). Please refer to CUSTOM GROMMET LOCATION FORM in the back reference section.
- Components that come standard with grommet may be ordered without a grommet. **Add \$35**.
- Grommets are available on modesty panels of extended corners and 5-sided corners 6 1/2" in where the two modesty panels meet at a 90° angle. Please specify FOGMPR for right grommet placement and FOGMPL for left grommet (placement is as shown on diagrams below). Cost is **\$65**.

• Modesty panels are 1" off of ground

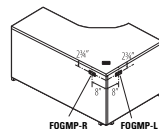

Left Extended Corner Unit

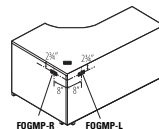

Right Extended Corner Unit

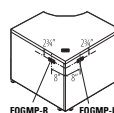

5-Sided Corner Unit

Power Block

- A Power Block (model PMSpDM) may be ordered on all worksurfaces.
- A Power Block is a rectangular worksurface power/data module with one electrical duplex receptacle and includes two data (CAT5) receptacles. 9 foot black cord included. Power Block dimensions are 3 1/2" deep x 6 1/2" wide x 2 3/4" high.
- To purchase a Power Block, you must specify both the Power Block cut-out location and the Power Block model #. Order Power Block as **PMSpDM, Add \$238**. Power Blocks are available in standard worksurface locations (left, center or right). Order as **E1, E2 or E3. Add \$65**.



Power Block **PMSpDM Add \$238**

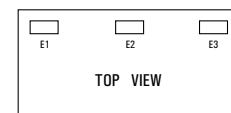

Specify location **E1, E2 or E3 Add \$65**

A ADAPTABILITIES®

DOUBLE PEDESTAL DESKS

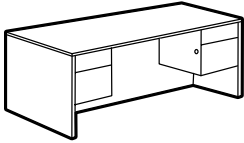

Double Pedestal Desk

MODEL#	DIMENSIONS D x W x H	FREIGHT CLASS	WT./LBS.	CUBIC FT.	LIST PRICE	HP ADD
A3672DP	36 x 72 x 29	150	296	52.50	\$1318	\$387
A3072DP	29.69 x 72 x 29	125	263	43	\$1295	\$362
A3066DP	29.69 x 66 x 29	125	254	39.75	\$1283	\$362
A3060DP	29.69 x 60 x 29	125	247	36.25	\$1171	\$336

Standard with box/file pedestals on both sides. Pedestals lock. One pencil tray.

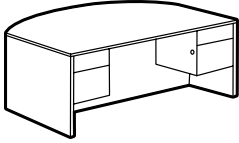

Double Pedestal Bow Top Desk

A3672DPB	30-36 x 72 x 29	150	280	52.50	\$1570	\$387
----------	-----------------	-----	-----	-------	---------------	--------------

Standard with box/file pedestals on both sides and bow top. Pedestals lock. One pencil tray.

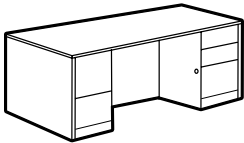

Full to Floor Double Pedestal Desk

A3672D4	36 x 72 x 29	125	330	52.50	\$1679	\$387
A3072D4	30 x 72 x 29	125	295	41.15	\$1650	\$387
A3066D4	29.69 x 66 x 29	125	285	39.75	\$1643	\$362
A3060D4	29.69 x 60 x 29	125	276	36.25	\$1531	\$336

Standard with full to floor box/box/file in right pedestal and file/file on left pedestal. Pedestals lock. On box/box/file pedestals, lower box drawer and file drawer lock. One pencil tray. Full to the floor pedestal configurations can be switched for a **15% upcharge**.

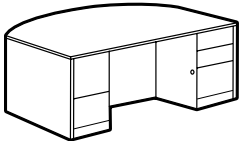

Full to Floor Double Pedestal Bow Top Desk

A3672DB4	32-36 x 72 x 29	150	311	52.50	\$1930	\$387
----------	-----------------	-----	-----	-------	---------------	--------------

Standard with full to floor box/box/file in right pedestal and file/file on left pedestal. Bow top. Pedestals lock. On box/box/file pedestals, lower box drawer and file drawer lock. One pencil tray. Full to the floor pedestal configurations can be switched for a **15% upcharge**.

SINGLE PEDESTAL DESKS

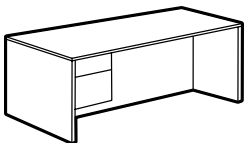

Single Pedestal Desk - LEFT

A3672SPL	36 x 72 x 29	150	245	52.50	\$1100	\$387
A3072SPL	29.69 x 72 x 29	150	216	43	\$966	\$362
A3066SPL	29.69 x 66 x 29	150	207	39.75	\$953	\$362
A3060SPL	29.69 x 60 x 29	150	197	36.25	\$949	\$336
A3048SPL	29.69 x 48 x 29	125	177	29.25	\$852	\$285
A2448SPL	24 x 48 x 29	125	150	24.25	\$852	\$185

Standard with box/file pedestal. Pedestal locks. One pencil tray. Pedestal is on the **left**.

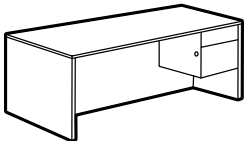

Single Pedestal Desk - RIGHT

A3672SPR	36 x 72 x 29	150	245	52.50	\$1100	\$387
A3072SPR	29.69 x 72 x 29	150	216	43	\$966	\$362
A3066SPR	29.69 x 66 x 29	150	207	39.75	\$953	\$362
A3060SPR	29.69 x 60 x 29	150	197	36.25	\$949	\$336
A3048SPR	29.69 x 48 x 29	125	177	29.25	\$852	\$285
A2448SPR	24 x 48 x 29	125	150	24.25	\$852	\$185

Standard with box/file pedestal. Pedestal locks. One pencil tray. Pedestal is on the **right**.

Required Specifications

Top finish
Base finish
Edge detail

Optional Specifications

Key #
Grommet/power block cut-out
HP laminate
Modesty panel

Accessories

Power block
Keyboard tray
Pencil tray

SINGLE PEDESTAL DESKS

MODEL# DIMENSIONS FREIGHT CLASS WT/LBS. CUBIC FT. LIST PRICE HP ADD

D x W x H

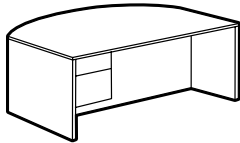

Single Pedestal Bow Top Desk - LEFT

A3672SLB 30-36 x 72 x 29 150 233 52.50 \$1346 \$387

Standard with box/file pedestal on **left** and bow top. Pedestal locks. One pencil tray.

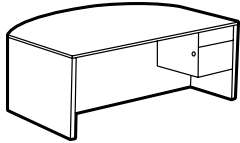

Single Pedestal Bow Top Desk - RIGHT

A3672SRB 30-36 x 72 x 29 150 233 52.50 \$1346 \$387

Standard with box/file pedestal on **right** and bow top. Pedestal locks. One pencil tray.

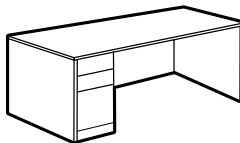

Full to Floor Single Pedestal Desk - LEFT

A3672S4L	36 x 72 x 29	150	261	52.50	\$1280	\$387
A3072S4L	29.69 x 72 x 29	150	232	43.75	\$1250	\$387
A3066S4L	29.69 x 66 x 29	150	221	39.50	\$1241	\$362
A3060S4L	29.69 x 60 x 29	150	211	36.25	\$1126	\$336
A3048S4L	29.69 x 48 x 29	125	191	29.50	\$992	\$285
A2448S4L	24 x 48 x 29	125	164	24.25	\$992	\$185

Standard with full to floor box/box/file pedestal on the **left**. One pencil tray. Lower box drawer and file drawer lock. Full to the floor pedestal configurations can be switched for a **15% upcharge**.

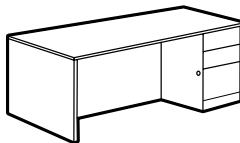

Full to Floor Single Pedestal Desk - RIGHT

A3672S4R	36 x 72 x 29	150	261	52.50	\$1280	\$387
A3072S4R	29.69 x 72 x 72	150	232	43.75	\$1250	\$387
A3066S4R	29.69 x 66 x 29	150	221	39.75	\$1241	\$362
A3060S4R	29.69 x 60 x 29	150	211	36.25	\$1126	\$336
A3048S4R	29.69 x 48 x 29	125	191	29.50	\$992	\$285
A2448S4R	24 x 48 x 29	125	164	24.25	\$992	\$185

Standard with full to floor box/box/file pedestal on the **right**. One pencil tray. Lower box drawer and file drawer lock. Full to the floor pedestal configurations can be switched for a **15% upcharge**.

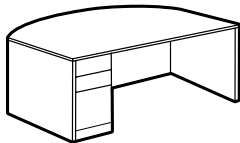

Full to Floor Single Pedestal Bow Top Desk - LEFT

A3672S4LB 32-36 x 72 x 29 150 247 52.50 \$1527 \$387

Standard with box/box/file pedestal on **left** and bow top. One pencil tray. Lower box drawer and file drawer lock. One pencil tray. Full to the floor pedestal configurations can be switched for a **15% upcharge**.

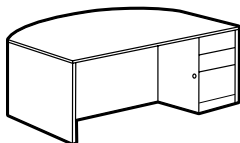

Full to Floor Single Pedestal Bow Top Desk - RIGHT

A3672S4RB 32-36 x 72 x 29 150 247 52.50 \$1527 \$387

Standard with box/box/file pedestal on **right** and bow top. One pencil tray. Lower box drawer and file drawer lock. One pencil tray. Full to the floor pedestal configurations can be switched for a **15% upcharge**.

Required Specifications

Top finish
Base finish
Edge detail

Optional Specifications

Key #
Grommet/power block cut-out
HP laminate
Modesty panel

Accessories

Power block
Keyboard tray
Pencil tray

A ADAPTABILITIES®

RETURNS

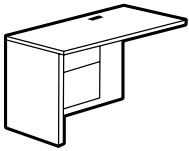

Flush Return - LEFT

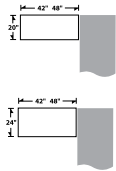

MODEL#	DIMENSIONS	FREIGHT CLASS	WT/LBS.	CUBIC FT.	LIST PRICE	HP ADD
D x W x H						
A2448FL	24 x 48 x 29	150	141	24	\$803	\$197
A2442FL	24 x 42 x 29	125	131	21.25	\$787	\$165
A2048FL	20 x 48 x 29	125	128	20.25	\$755	\$165
A2042FL	20 x 42 x 29	125	119	18	\$740	\$165

Standard with box/file drawer pedestal. One pencil tray. Pedestal locks. Grommet in worksurface. Pedestal is on the **left**.

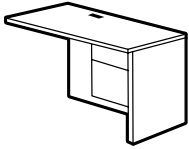

Flush Return - RIGHT

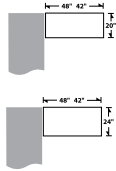

A2448FR	24 x 48 x 29	150	141	24	\$803	\$197
A2442FR	24 x 42 x 29	125	131	21.25	\$787	\$165
A2048FR	20 x 48 x 29	125	128	20.25	\$755	\$165
A2042FR	20 x 42 x 29	125	119	18	\$740	\$165

Standard with box/file drawer pedestal. One pencil tray. Pedestal locks. Grommet in worksurface. Pedestal is on the **right**.

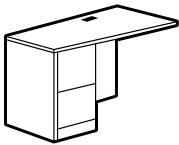

Full to Floor Flush Return - LEFT

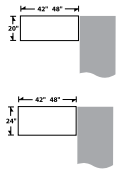

A2448L4	24 x 48 x 29	125	156	24.25	\$983	\$197
A2442L4	24 x 42 x 29	125	146	21.50	\$968	\$165
A2048L4	20 x 48 x 29	125	142	20.50	\$935	\$165
A2042L4	20 x 42 x 29	125	133	18	\$921	\$165

Standard with file/file drawer pedestal. One pencil tray. Pedestal locks. Grommet in worksurface. Pedestal is on the **left**. Full to the floor pedestal configurations can be switched for a **15% upcharge**.

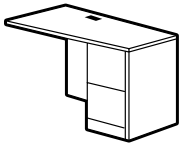

Full to Floor Flush Return - RIGHT

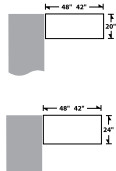

A2448R4	24 x 48 x 29	125	156	24.25	\$983	\$197
A2442R4	24 x 42 x 29	125	146	21.50	\$968	\$165
A2048R4	20 x 48 x 29	125	142	20.50	\$935	\$165
A2042R4	20 x 42 x 29	125	133	18	\$921	\$165

Standard with file/file drawer pedestal. One pencil tray. Pedestal locks. Grommet in worksurface. Pedestal is on the **right**. Full to the floor pedestal configurations can be switched for a **15% upcharge**.

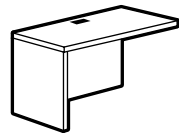

Flush Return - LEFT

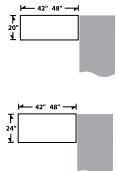

A2448EL	24 x 48 x 29	70	92	4.30	\$582	\$197
A2442EL	24 x 42 x 29	70	82	3.80	\$563	\$165
A2048EL	20 x 48 x 29	70	84	4.30	\$531	\$165
A2042EL	20 x 42 x 29	70	75	3.80	\$517	\$165

Return has no pedestal. Grommet in worksurface. Shipped RTA (ready to assemble).

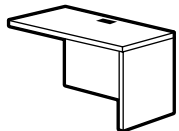

Flush Return - RIGHT

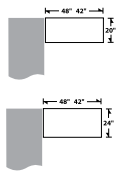

A2448ER	24 x 48 x 29	70	92	4.30	\$582	\$197
A2442ER	24 x 42 x 29	70	82	3.80	\$563	\$165
A2048ER	20 x 48 x 29	70	84	4.30	\$531	\$165
A2042ER	20 x 42 x 29	70	75	3.80	\$517	\$165

Return has no pedestal. Grommet in worksurface. Shipped RTA (ready to assemble).

Required Specifications

Top finish
Base finish
Edge detail

Optional Specifications

Key #*
Grommet/power block cut-out
HP laminate

Accessories

Power block
Keyboard tray
Pencil tray

RETURNS

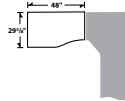
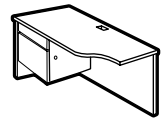

Space Saver Return - LEFT

MODEL#	DIMENSIONS	FREIGHT CLASS	WT/LBS.	CUBIC FT.	LIST PRICE	HP ADD
D x W x H						
A3048FSL	29.69 x 48 x 29	150	148	29	\$852	\$285

Standard with box/file pedestal on the **left**, grommet in worksurface. One pencil tray. Pedestal locks. Connects to 24"D 5-sided corner unit and 2466/2472 NFL or NNL extended corner unit.

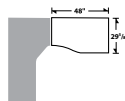
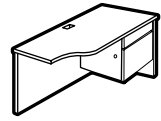

Space Saver Return - RIGHT

A3048FSR	29.69 x 48 x 29	150	148	29	\$852	\$285
----------	-----------------	-----	-----	----	--------------	--------------

Standard with box/file pedestal on the **right**, grommet in worksurface. One pencil tray. Pedestal locks. Connects to 24"D 5-sided corner unit and 2466/2472 FNR or NNR extended corner unit.

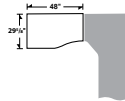
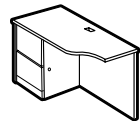

Space Saver Return - LEFT

A3048P4L	29.69 x 48 x 29	150	170	29	\$1031	\$285
----------	-----------------	-----	-----	----	---------------	--------------

Standard with file/file pedestal on the **left**, grommet in worksurface. One pencil tray. Pedestal locks. Connects to 24"D 5-sided corner unit and 2466/2472 NFL or NNL extended corner unit. Full to the floor pedestal configurations can be switched for a **15% upcharge**.

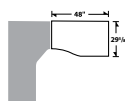
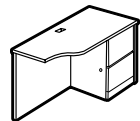

Space Saver Return - RIGHT

A3048P4R	29.69 x 48 x 29	150	170	29	\$1031	\$285
----------	-----------------	-----	-----	----	---------------	--------------

Standard with file/file pedestal on the **right**, grommet in worksurface. One pencil tray. Pedestal locks. Connects to 24"D 5-sided corner unit and 2466/2472 FNR or NNR extended corner unit. Full to the floor pedestal configurations can be switched for a **15% upcharge**.

FLUSH BRIDGE

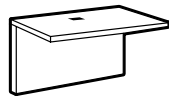

Flush Bridge*

A2448FB	24 x 48 x 29	70	75	4.30	\$437	\$197
A2442FB	24 x 42 x 29	70	65	3.80	\$420	\$165
A2436FB	24 x 36 x 29	70	58	3.30	\$420	\$124
A2048FB	20 x 48 x 29	70	71	4.30	\$420	\$165
A2042FB	20 x 42 x 29	70	65	3.80	\$403	\$165
A2036FB	20 x 36 x 29	70	54	3.30	\$403	\$83

Top surface, back panel and hardware to connect two units. Grommet in worksurface. Shipped RTA (ready to assemble).

CREDENZAS



Center Storage Credenza

A2072C	20 x 72 x 29	100	243	30	\$1585	\$258
--------	--------------	-----	-----	----	---------------	--------------

Standard with box/file pedestals on both sides and self-closing hinged center doors covering one adjustable shelf. Pedestals and doors lock. One pencil tray.

Required Specifications

Top finish
Base finish
Handles**
Edge detail

Optional Specifications

Key #
Additional grommet position (not A2072C)
HP laminate
Power block cut-out (not A2072C)

Accessories

Power block
Keyboard tray*
Pencil tray*

A ADAPTABILITIES®

CREDENZAS

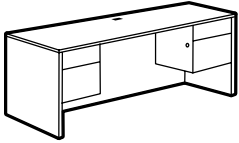

Kneespace Credenza

MODEL#	DIMENSIONS D x W x H	FREIGHT CLASS	WT/LBS.	CUBIC FT.	LIST PRICE	HP ADD
A2472CK	24 x 72 x 29	125	234	35.75	\$1325	\$269
A2466CK	24 x 66 x 29	125	225	32.75	\$1287	\$269
A2072CK	20 x 72 x 29	125	212	30.25	\$1211	\$258
A2066CK	20 x 66 x 29	125	204	27.75	\$1193	\$248
A2060CK	20 x 60 x 29	125	199	25.25	\$1163	\$228

Standard with box/file pedestals on both sides. Center is open. Pedestals lock. One pencil tray. Grommet in worksurface.

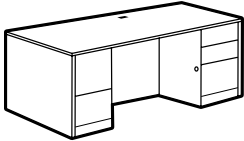

Full to Floor Kneespace Credenza

A2472D4	24 x 72 x 29	125	261	35.50	\$1680	\$269
A2466D4	24 x 66 x 29	125	252	33	\$1644	\$269
A2072D4	20 x 72 x 29	125	236	30	\$1570	\$258
A2066D4	20 x 66 x 29	100	228	27.75	\$1554	\$248
A2060D4	20 x 60 x 29	100	220	25.25	\$1546	\$228

Standard with full to floor box/box/file in right pedestal and file/file on left pedestal. Pedestals lock on box/box/file pedestals, lower box drawer and file drawer lock. One pencil tray. Grommet in worksurface.

- Full to the floor pedestal configurations can be switched for a **15% upcharge**.

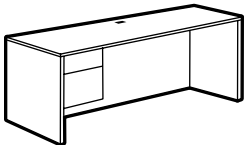

Single Pedestal Credenza - LEFT

A2472CSL	24 x 72 x 29	150	190	35.75	\$1123	\$269
A2466CSL	24 x 66 x 29	150	181	32.75	\$1085	\$269
A2072CSL	20 x 72 x 29	150	172	30.25	\$1012	\$258
A2066CSL	20 x 66 x 29	150	163	27.75	\$996	\$248
A2060CSL	20 x 60 x 29	125	155	25.25	\$963	\$228

Standard with box/file pedestal. Pedestal locks. One pencil tray. Pedestal is on the **left**. Grommet in worksurface.

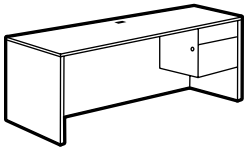

Single Pedestal Credenza - RIGHT

A2472CSR	24 x 72 x 29	150	190	35.75	\$1123	\$269
A2466CSR	24 x 66 x 29	150	181	32.75	\$1085	\$269
A2072CSR	20 x 72 x 29	150	171	30	\$1012	\$258
A2066CSR	20 x 66 x 29	150	163	27.75	\$996	\$248
A2060CSR	20 x 60 x 29	125	155	25.25	\$963	\$228

Standard with box/file pedestal. Pedestal locks. One pencil tray. Pedestal is on the **right**. Grommet in worksurface.

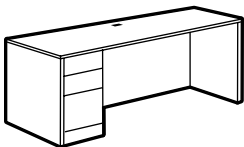

Full to Floor Single Pedestal Credenza - LEFT

A2472S4L	24 x 72 x 29	150	205	35.50	\$1280	\$269
A2466S4L	24 x 66 x 29	150	196	33	\$1241	\$269
A2072S4L	20 x 72 x 29	125	187	30	\$1126	\$258
A2066S4L	20 x 66 x 29	125	177	27.75	\$1105	\$258
A2060S4L	20 x 60 x 29	125	168	25.25	\$1077	\$228

Standard with full to floor box/box/file pedestal on the **left**. Lower box drawer and file drawer lock. Grommet in worksurface. One pencil tray.

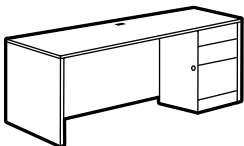

Full to Floor Single Pedestal Credenza - RIGHT

A2472S4R	24 x 72 x 29	150	205	35.50	\$1280	\$269
A2466S4R	24 x 66 x 29	150	196	33	\$1241	\$269
A2072S4R	20 x 72 x 29	125	187	30	\$1126	\$258
A2066S4R	20 x 66 x 29	125	177	27.75	\$1105	\$258
A2060S4R	20 x 60 x 29	125	168	25.25	\$1077	\$228

Standard with full to floor box/box/file pedestal on the **right**. Lower box drawer and file drawer lock. Grommet in worksurface. One pencil tray.

Required Specifications

Top finish
Base finish
Edge detail

Optional Specifications

Key #
Grommet/power block cut-out
HP laminate

Accessories

Power block
Keyboard tray
Pencil tray

CREDENZAS

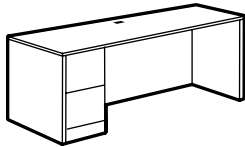

Full to Floor Single Pedestal Credenza- LEFT*

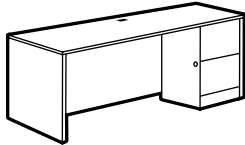

Full to Floor Single Pedestal Credenza- RIGHT*

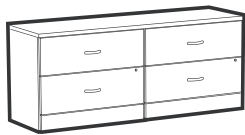

Lateral File Credenza

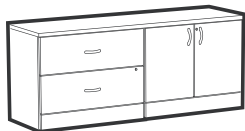

Lateral File/Storage Cabinet Credenza



Kneespace Lateral File Credenza - LEFT*



Kneespace Lateral File Credenza - RIGHT*

MODEL#	DIMENSIONS	FREIGHT CLASS	WT./LBS.	CUBIC FT.	LIST PRICE	HP ADD
--------	------------	---------------	----------	-----------	------------	--------

D x W x H

A2472S2L	24 x 72 x 29	150	205	35.50	\$1280	\$269
A2466S2L	24 x 66 x 29	150	196	33	\$1241	\$269
A2072S2L	20 x 72 x 29	125	187	30	\$1126	\$258
A2066S2L	20 x 66 x 29	125	177	27.75	\$1105	\$258
A2060S2L	20 x 60 x 29	125	168	25.25	\$1077	\$228

Standard with full to floor file/file pedestal on the **left**. Pedestal Locks. Grommet in worksurface.

A2472S2R	24 x 72 x 29	150	205	35.50	\$1280	\$269
A2466S2R	24 x 66 x 29	150	196	33	\$1241	\$269
A2072S2R	20 x 72 x 29	125	187	30	\$1126	\$258
A2066S2R	20 x 66 x 29	125	177	27.75	\$1105	\$258
A2060S2R	20 x 60 x 29	125	168	25.25	\$1077	\$228

Standard with full to floor file/file pedestal on the **right**. Pedestal locks. Grommet in worksurface.

A2472LF2	24 x 72 x 29	100	322	35.75	\$1936	\$269
A2072LF2	20 x 72 x 29	100	296	30.25	\$1897	\$258

Two 2-drawer lateral files side-by-side. Locking drawers, keyed alike. File bars included for side-to-side and front-to-back letter/legal filing capability. Anti-lock tilt suspension.

- Black handles are standard. Silver is available at no charge, please specify as **SI**.
- *File drawer construction is for accommodating hanging files NOT for stacking materials on the drawer bottom.*

A2472LS	24 x 72 x 29	100	297	35.75	\$1733	\$269
A2072LS	20 x 72 x 29	100	267	30.25	\$1693	\$258

One 2-drawer lateral file and one storage cabinet. Locking doors/drawers, keyed alike. Storage cabinet includes one adjustable shelf. File bars included for side-to-side and front-to-back letter/legal filing capability. Anti-lock tilt suspension.

- Black handles are standard. Silver is available at no charge, please specify as **SI**.
- *File drawer construction is for accommodating hanging files NOT for stacking materials on the drawer bottom.*

A2472LKL	24 x 72 x 29	125	239	35.75	\$1522	\$269
A2072LKL	20 x 72 x 29	125	216	30.25	\$1483	\$258

One 2-drawer lateral file on the **left**. Locking drawers. File bars included for side-to-side and front-to-back letter/legal filing capability. Anti-lock tilt suspension. Grommet in worksurface.

- Black handles are standard. Silver is available at no charge, please specify as **SI**.
- *File drawer construction is for accommodating hanging files NOT for stacking materials on the drawer bottom.*

A2472LKR	24 x 72 x 29	125	239	35.75	\$1522	\$269
A2072LKR	20 x 72 x 29	125	216	30.25	\$1483	\$258

One 2-drawer lateral file on the **right**. Locking drawers. File bars included for side-to-side and front-to-back letter/legal filing capability. Anti-lock tilt suspension. Grommet in worksurface.

- Black handles are standard. Silver is available at no charge, please specify as **SI**.
- *File drawer construction is for accommodating hanging files NOT for stacking materials on the drawer bottom.*

Required Specifications

Top finish
Base finish
Handles (not A2xxxS2L/A2xxxS2R)
Edge detail

Optional Specifications

Key #
Additional grommet
HP laminate
Power block cut-out*

Accessories

Power block*
Keyboard tray*
Pencil tray*

A ADAPTABILITIES®

CREDENZAS

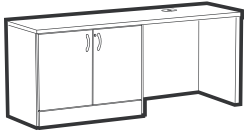

Kneespace Storage Cabinet Credenza - LEFT

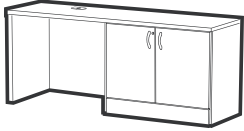

Kneespace Storage Cabinet Credenza - RIGHT

MODEL#	DIMENSIONS	FREIGHT CLASS	WT/LBS.	CUBIC FT.	LIST PRICE	HP ADD
--------	------------	---------------	---------	-----------	------------	--------

D x W x H

A2472SKL	24 x 72 x 29	125	218	35.75	\$1201	\$269
A2072SKL	20 x 72 x 29	125	188	30.25	\$1162	\$258

One storage cabinet on the **left**. Locking doors. Storage cabinet has one adjustable shelf. Grommet in worksurface.
 • Black handles are standard. Silver is available at no charge, please specify as **SI**.

A2472SKR	24 x 72 x 29	125	218	35.75	\$1201	\$269
A2072SKR	20 x 72 x 29	125	188	30.25	\$1162	\$258

One storage cabinet on the **right**. Locking doors. Storage cabinet has one adjustable shelf. Grommet in worksurface.
 • Black handles are standard. Silver is available at no charge, please specify as **SI**.

5-SIDED CORNERS

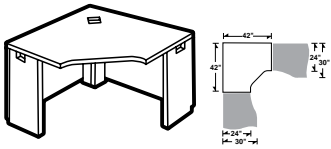

5-Sided Corner

A42245C	42 x 42 x 29	70	113	5.75	\$752	\$362
---------	--------------	----	-----	------	--------------	--------------

Connects to **30" D** space saver connectable surfaces, **24" D** connectables, returns and bridge. Grommet in worksurface. Narrow end panels on left and right. Predrilled to accept MPOKST2 or 22" keyboard trays. **Will not accept keyboard trays wider than 22"**. Shipped RTA (ready to assemble). *Not Freestanding*.
 • **Modesty Panel is 1" off of ground.**
 • Full End Panel(s) are available - add **15% upcharge**

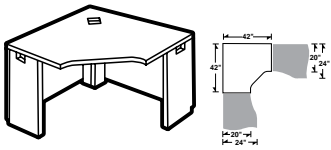

5-Sided Corner

A42205C	42 x 42 x 29	70	110	5.75	\$729	\$362
---------	--------------	----	-----	------	--------------	--------------

Connects to **24" D** space saver connectable surfaces, **20" D** returns, lateral files, storage/lateral file credenzas, credenzas, bridges and end shelves. Grommet in worksurface. Narrow end panels on left and right. Predrilled to accept MPOKST2 or 22-28" keyboard trays. **Will not accept keyboard trays wider than 28"**. Shipped RTA (ready to assemble). *Not freestanding*.
 • **Modesty Panel is 1" off of ground.**
 • Full End Panel(s) are available - add **15% upcharge**

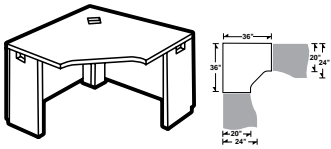

5-Sided Corner

A36205C	36 x 36 x 29	70	94	4.80	\$645	\$233
---------	--------------	----	----	------	--------------	--------------

Connects to **24" D** space saver connectable surfaces, **20" D** returns, lateral files, storage/lateral file credenzas, credenzas, bridges and end shelves. Grommet in worksurface. Narrow end panels on left and right. Predrilled to accept MPOKST2 or 22" keyboard trays. **Will not accept keyboard trays wider than 22"**. Shipped RTA (ready to assemble). *Not freestanding*.
 • **Modesty Panel is 1" off of ground.**
 • Full End Panel(s) are available - add **15% upcharge**

Required Specifications

Top finish
 Base finish
 Handles (only credenzas)
 Edge detail

Optional Specifications

Key #
 Additional grommet position
 HP laminate
 Power block cut-out

Accessories

Power block
 Keyboard tray*
 Pencil tray

LEFT EXTENDED CORNERS

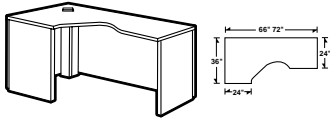

Left Extended Corner - Freestanding

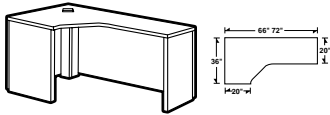

Left Extended Corner

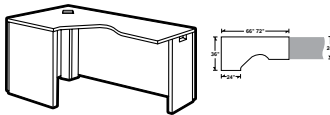

Left Extended Corner

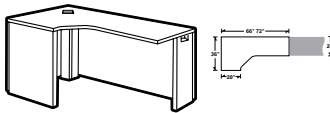

Left Extended Corner

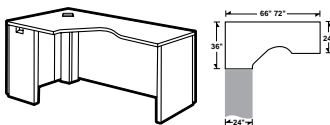

Left Extended Corner

MODEL#	DIMENSIONS	FREIGHT CLASS	WT./LBS.	CUBIC FT.	LIST PRICE	HP ADD
--------	------------	---------------	----------	-----------	------------	--------

D x W x H

A2472FFL	24-36 x 72 x 29	70	157	7	\$966	\$387
A2466FFL	24-36 x 66 x 29	70	151	7	\$966	\$387

Extended worksurface on right. **Full end panels on left and right. Cannot be connected on left or right, due to full end panel.** Corner has one grommet. Predrilled to accept MPOKST2 or 22" keyboard trays. **Will not accept keyboard trays wider than 22"**. Shipped RTA (ready to assemble).

- **Modesty Panel is 1" off of ground.**
- **A2466FFL cannot accept pedestals.**

A2072FFL	20-36 x 72 x 29	70	147	7	\$923	\$371
A2066FFL	20-36 x 66 x 29	70	141	7	\$923	\$371

Extended worksurface on right. **Full end panels on left and right. Cannot be connected on left or right, due to full end panel.** Corner has one grommet. Predrilled to accept MPOKST2 or 22" keyboard trays. **Will not accept keyboard trays wider than 22"**. Shipped RTA (ready to assemble).

- **Modesty Panel is 1" off of ground.**

A2472FNL	24-36 x 72 x 29	70	149	7	\$934	\$387
A2466FNL	24-36 x 66 x 29	70	142	7	\$934	\$387

Extended worksurface on right. **Narrow end panel on right. Full end panel on left.** Connects to 30"D space saver connectables, 24"D returns or 24"D connectable tables. **Full end panel cannot be connected.** Corner has one grommet. Predrilled to accept MPOKST2 or 22" keyboard trays. **Will not accept keyboard trays wider than 22"**. Shipped RTA (ready to assemble).

- **Modesty Panel is 1" off of ground.**
- **A2466FNL cannot accept pedestals.**

A2072FNL	20-36 x 72 x 29	70	141	7	\$890	\$371
A2066FNL	20-36 x 66 x 29	70	135	7	\$890	\$371

Extended worksurface on right. **Narrow end panel on right. Full end panel on left.** Connects to 24"D space saver connectables, 20"D returns or 20"D connectable tables. **Full end panel cannot be connected.** Corner has one grommet. Predrilled to accept MPOKST2 or 22" keyboard trays. **Will not accept keyboard trays wider than 22"**. Shipped RTA (ready to assemble).

- **Modesty Panel is 1" off of ground.**

A2472NFL	24-36 x 72 x 29	70	149	7	\$934	\$387
A2466NFL	24-36 x 66 x 29	70	142	7	\$934	\$387

Extended worksurface on right. **Narrow end panel on left. Full end panel on right.** Connects to 30"D space saver connectables, 24"D returns or 24"D connectable tables. **Full end panel cannot be connected.** Corner has one grommet. Predrilled to accept MPOKST2 or 22" keyboard trays. **Will not accept keyboard trays wider than 22"**. Shipped RTA (ready to assemble).

- **Modesty Panel is 1" off of ground.**
- **A2466NFL cannot accept pedestals.**

Required Specifications

Top finish
Base finish
Edge detail

Optional Specifications

Additional grommet position
HP laminate
Power block cut-out

Accessories

Power block
Keyboard tray
Pencil tray

LEFT EXTENDED CORNERS

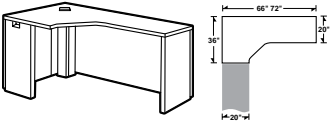

Left Extended Corner

MODEL#	DIMENSIONS D x W x H	FREIGHT CLASS	WT/LBS.	CUBIC FT.	LIST PRICE	HP ADD
A2072NFL	20-36 x 72 x 29	70	141	7	\$890	\$387
A2066NFL	20-36 x 66 x 29	70	135	7	\$890	\$371

Extended worksurface on right. **Narrow end panel on left. Full end panel on right.** Connects to 24"D space saver connectables and 20"D returns. **Full end panel cannot be connected.** Corner has one grommet. Predrilled to accept MPOKST2 or 22" keyboard trays. **Will not accept keyboard trays wider than 22"**. Shipped RTA (ready to assemble).

- Modesty Panel is 1" off of ground.

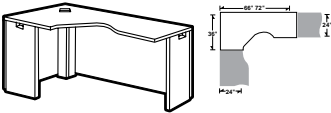

Left Extended Corner

A2472NNL	24-36 x 72 x 29	70	140	7	\$903	\$387
A2466NNL	24-36 x 66 x 29	70	134	7	\$903	\$387

Extended worksurface on right. **Narrow end panels on left and right.** Connects to 30"D space saver connectables, 24"D returns and 24"D connectable tables on either end. Corner has one grommet. Predrilled to accept MPOKST2 or 22" keyboard trays. **Will not accept keyboard trays wider than 22"**. Shipped RTA (ready to assemble).

- Modesty Panel is 1" off of ground.
- A2466NNL cannot accept pedestals.

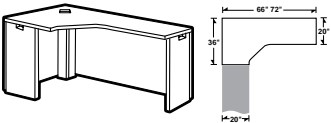

Left Extended Corner

A2072NNL	20-36 x 72 x 29	70	136	7	\$878	\$387
A2066NNL	20-36 x 66 x 29	70	130	7	\$878	\$371

Extended worksurface on right. **Narrow end panels on left and right.** Connects to 24"D space saver connectables and 20"D returns or bridge on either end. Corner has one grommet. Predrilled to accept MPOKST2 or 22" keyboard trays. **Will not accept keyboard trays wider than 22"**. Shipped RTA (ready to assemble).

- Modesty Panel is 1" off of ground.

RIGHT EXTENDED CORNERS

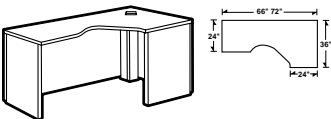

Right Extended Corner - Freestanding

A2472FFR	24-36 x 72 x 29	70	157	7	\$966	\$387
A2466FFR	24-36 x 66 x 29	70	151	7	\$966	\$387

Extended worksurface on left. **Full end panels on left and right. Cannot be connected on left or right, due to full end panel.** Corner has one grommet. Predrilled to accept MPOKST2 or 22" keyboard trays. **Will not accept keyboard trays wider than 22"**. Shipped RTA (ready to assemble).

- Modesty Panel is 1" off of ground.
- A2466FFR cannot accept pedestals.

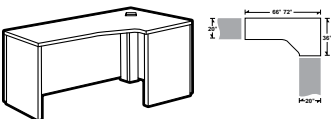

Right Extended Corner

A2072FFR	20-36 x 72 x 29	70	147	7	\$923	\$371
A2066FFR	20-36 x 66 x 29	70	141	7	\$923	\$371

Extended worksurface on left. **Full end panels on left and right. Cannot be connected on left or right, due to full end panel.** Corner has one grommet. Predrilled to accept MPOKST2 or 22" keyboard trays. **Will not accept keyboard trays wider than 22"**. Shipped RTA (ready to assemble).

- Modesty Panel is 1" off of ground.

Required Specifications

Top finish
Base finish
Edge detail

Optional Specifications

Additional grommet position
HP laminate
Power block cut-out

Accessories

Power block
Keyboard tray
Pencil tray

RIGHT EXTENDED CORNERS

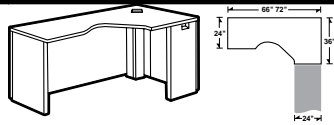

Right Extended Corner

MODEL#	DIMENSIONS	FREIGHT CLASS	WT/LBS.	CUBIC FT.	LIST PRICE	HP ADD
D x W x H						
A2472FNR	24-36 x 72 x 29	70	149	7	\$934	\$387
A2466FNR	24-36 x 66 x 29	70	142	7	\$934	\$387

Extended worksurface on left. **Narrow end panel on right. Full end panel on left.** Connects to 30"D space saver connectables, 24"D returns or 24"D connectable tables. **Full end panel cannot be connected.** Corner has one grommet. Predrilled to accept MPOKST2 or 22" keyboard trays. **Will not accept keyboard trays wider than 22"**. Shipped RTA (ready to assemble).

- **Modesty Panel is 1" off of ground.**
- **A2466FNR cannot accept pedestals.**

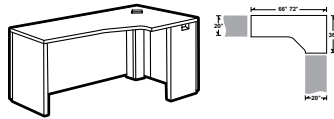

Right Extended Corner

A2072FNR	20-36 x 72 x 29	70	141	7	\$890	\$371
A2066FNR	20-36 x 66 x 29	70	135	7	\$890	\$371

Extended worksurface on left. **Narrow end panel on right. Full end panel on left.** Connects to 24"D space saver connectables, 20"D returns or 20"D connectable tables. **Full end panel cannot be connected.** Corner has one grommet. Predrilled to accept MPOKST2 or 22" keyboard trays. **Will not accept keyboard trays wider than 22"**. Shipped RTA (ready to assemble).

- **Modesty Panel is 1" off of ground.**

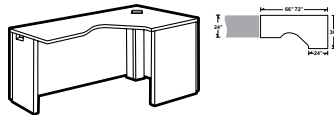

Right Extended Corner

A2472NFR	24-36 x 72 x 29	70	149	7	\$934	\$387
A2466NFR	24-36 x 66 x 29	70	142	7	\$934	\$387

Extended worksurface on left. **Narrow end panel on left. Full end panel on right.** Connects to 30"D space saver connectables, 24"D returns or 24"D connectable tables. **Full end panel cannot be connected.** Corner has one grommet. Predrilled to accept MPOKST2 or 22" keyboard trays. **Will not accept keyboard trays wider than 22"**. Shipped RTA (ready to assemble).

- **Modesty Panel is 1" off of ground.**
- **A2466NFR cannot accept pedestals.**

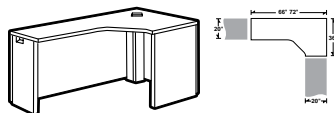

Right Extended Corner

A2072NFR	20-36 x 72 x 29	70	141	7	\$890	\$387
A2066NFR	20-36 x 66 x 29	70	135	7	\$890	\$371

Extended worksurface on left. **Narrow end panel on left. Full end panel on right.** Connects to 24"D space saver connectables and 20"D returns. **Full end panel cannot be connected.** Corner has one grommet. Predrilled to accept MPOKST2 or 22" keyboard trays. **Will not accept keyboard trays wider than 22"**. Shipped RTA (ready to assemble).

- **Modesty Panel is 1" off of ground.**

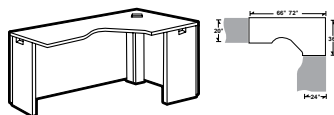

Right Extended Corner

A2472NNR	24-36 x 72 x 29	70	140	7	\$903	\$387
A2466NNR	24-36 x 66 x 29	70	133	7	\$903	\$387

Extended worksurface on left. **Narrow end panels on left and right.** Connects to 30"D space saver connectables, 24"D returns and 24"D connectable tables on either end. Corner has one grommet. Predrilled to accept MPOKST2 or 22" keyboard trays. **Will not accept keyboard trays wider than 22"**. Shipped RTA (ready to assemble).

- **Modesty Panel is 1" off of ground.**
- **A2466NNR cannot accept pedestals.**

Required Specifications

Top finish
Base finish
Edge detail

Optional Specifications

Additional grommet position
HP laminate
Power block cut-out

Accessories

Power block
Keyboard tray
Pencil tray

RIGHT EXTENDED CORNERS

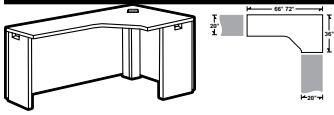

Right Extended Corner

MODEL#	DIMENSIONS	FREIGHT CLASS	WT/LBS.	CUBIC FT.	LIST PRICE	HP ADD
	D x W x H					
A2072NNR	20-36 x 72 x 29	70	136	7	\$878	\$387
A2066NNR	20-36 x 66 x 29	70	130	7	\$878	\$371

Extended worksurface on left. **Narrow end panels on left and right.** Connects to 24"D space saver connectables and 20"D returns or bridge on either end. Corner has one grommet. Predrilled to accept MPOKST2 or 22" keyboard trays. **Will not accept keyboard trays wider than 22"**. Shipped RTA (ready to assemble).

- Modesty Panel is 1" off of ground.

FREESTANDING TABLES

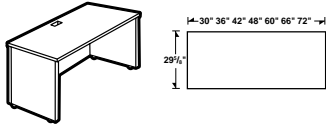

30" Deep Freestanding Table

A3072T	29.69 x 72 x 29	65	148	6	\$740	\$362
A3066T	29.69 x 66 x 29	65	140	6	\$740	\$362
A3060T	29.69 x 60 x 29	65	131	5.25	\$676	\$336
A3048T	29.69 x 48 x 29	70	116	5.25	\$612	\$285
A3042T	29.69 x 42 x 29	70	108	5.25	\$612	\$258
A3036T	29.69 x 36 x 29	65	97	4.30	\$549	\$233
A3030T	29.69 x 30 x 29	65	88	3.60	\$517	\$207

Two full end panels. Cannot be connected on left or right side. Grommet in worksurface. Shipped RTA (ready to assemble).

- Modesty Panel is 1" off of ground

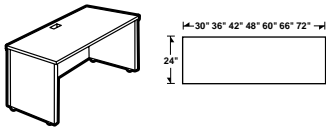

24" Deep Freestanding Table

A2472T	24 x 72 x 29	70	130	6	\$676	\$269
A2466T	24 x 66 x 29	70	123	6	\$676	\$269
A2460T	24 x 60 x 29	70	114	5.25	\$612	\$248
A2448T	24 x 48 x 29	65	99	4.30	\$549	\$197
A2442T	24 x 42 x 29	70	92	4.30	\$549	\$165
A2436T	24 x 36 x 29	70	84	4.20	\$486	\$124
A2430T	24 x 30 x 29	70	76	3.60	\$453	\$124

Two full end panels. Cannot be connected on left or right side. Grommet in worksurface. Shipped RTA (ready to assemble).

- Modesty Panel is 1" off of ground

CONNECTABLE TABLES - LEFT

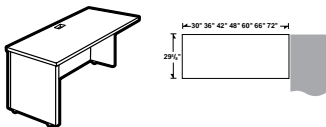

30" Deep Connectable Table - LEFT

A3072L	29.69 x 72 x 29	65	140	6	\$714	\$362
A3066L	29.69 x 66 x 29	70	132	6	\$714	\$362
A3060L	29.69 x 60 x 29	65	123	5.25	\$653	\$336
A3048L	29.69 x 48 x 29	65	105	4.30	\$588	\$285
A3042L	29.69 x 42 x 29	65	98	4.30	\$588	\$258
A3036L	29.69 x 36 x 29	70	88	4.20	\$524	\$233
A3030L	29.69 x 30 x 29	70	80	3.60	\$493	\$207

Full end panel on left. Right narrow end panel connects to 30"D center/right connectable table, or at 90° angle to a freestanding table; and "D" islands or "P" islands with "T" and "H" bases. Grommet in worksurface. Shipped RTA (ready to assemble).

- Modesty Panel is 1" off of ground.

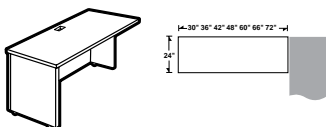

24" Deep Connectable Table - LEFT

A2472L	24 x 72 x 29	70	121	6	\$653	\$269
A2466L	24 x 66 x 29	70	115	6	\$653	\$269
A2460L	24 x 60 x 29	70	106	5.25	\$588	\$248
A2448L	24 x 48 x 29	70	90	4.30	\$524	\$197
A2442L	24 x 42 x 29	70	82	3.80	\$524	\$165
A2436L	24 x 36 x 29	70	74	3.30	\$461	\$124
A2430L	24 x 30 x 29	70	68	3.60	\$429	\$124

Full end panel on left. Right narrow end panel connects to 24"D center/right connectable table, or at 90° angle to a freestanding table; 24"D extended corners, 42" 5-sided corners or at the end of a straight run; "D" islands or "P" islands with "T" and "H" bases. Grommet in worksurface. Shipped RTA (ready to assemble).

- Modesty Panel is 1" off of ground.

Required Specifications

Top finish
Base finish
Edge detail

Optional Specifications

Additional grommet position
HP laminate
Power block cut-out

Accessories

Power block
Keyboard tray
Pencil tray

CONNECTABLE TABLES - RIGHT

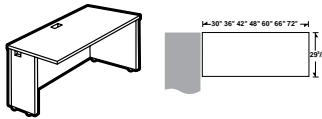

30" Deep Connectable Table - RIGHT

MODEL#	DIMENSIONS	FREIGHT CLASS	WT./LBS.	CUBIC FT.	LIST PRICE	HP ADD
D x W x H						
A3072R	29.69 x 72 x 29	65	140	6	\$714	\$362
A3066R	29.69 x 66 x 29	70	132	6	\$714	\$362
A3060R	29.69 x 60 x 29	65	123	5.25	\$653	\$336
A3048R	29.69 x 48 x 29	65	105	4.30	\$588	\$285
A3042R	29.69 x 42 x 29	65	98	4.30	\$588	\$258
A3036R	29.69 x 36 x 29	70	88	4.30	\$524	\$233
A3030R	29.69 x 30 x 29	70	80	3.60	\$493	\$207

Full end panel on **right**. Left narrow end panel connects to 30"D center/left connectable table, or at 90° angle to a freestanding table; "D" islands or "P" islands with "T" and "H" bases. Grommet in worksurface. Shipped RTA (ready to assemble).

- Modesty Panel is 1" off of ground

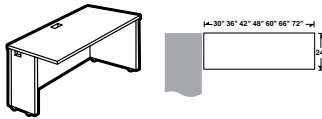

24" Deep Connectable Table - RIGHT

A2472R	24 x 72 x 29	70	121	6	\$653	\$269
A2466R	24 x 66 x 29	70	115	6	\$653	\$269
A2460R	24 x 60 x 29	70	105	5.25	\$588	\$248
A2448R	24 x 48 x 29	70	90	4.30	\$524	\$197
A2442R	24 x 42 x 29	70	82	3.80	\$524	\$165
A2436R	24 x 36 x 29	70	74	3.30	\$461	\$124
A2430R	24 x 30 x 29	70	67	3.60	\$429	\$124

Full end panel on **right**. Left narrow end panel connects to 24"D center/left connectable table, or at 90° angle to a freestanding table; 24"D extended corners, 42" 5-sided corners or at the end of a straight run; "D" islands or "P" islands with "T" and "H" bases. Grommet in worksurface. Shipped RTA (ready to assemble).

- Modesty Panel is 1" off of ground

CONNECTABLE TABLES

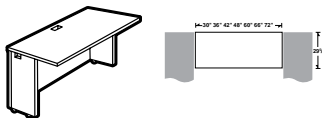

30" Deep Connectable Table

A3072N	29.69 x 72 x 29	70	131	6	\$692	\$362
A3066N	29.69 x 66 x 29	70	124	6	\$692	\$362
A3060N	29.69 x 60 x 29	70	114	5.25	\$626	\$336
A3048N	29.69 x 48 x 29	65	97	4.30	\$563	\$285
A3042N	29.69 x 42 x 29	65	89	3.80	\$563	\$258
A3036N	29.69 x 36 x 29	65	80	3.30	\$500	\$233
A3030N	29.69 x 30 x 29	70	71	3.60	\$467	\$207

Narrow end panels on both sides connects to 30"D worksurfaces; "D" islands or "P" islands with "T" and "H" bases; or at 90° angle to freestanding table(s). Grommet in worksurface. Shipped RTA (ready to assemble).

- Modesty Panel is 1" off of ground

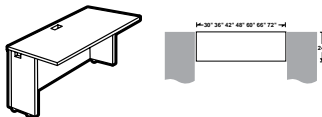

24" Deep Connectable Table

A2472N	24 x 72 x 29	70	113	6	\$626	\$269
A2466N	24 x 66 x 29	70	105	6	\$626	\$269
A2460N	24 x 60 x 29	70	100	4.50	\$563	\$248
A2448N	24 x 48 x 29	70	82	4.30	\$500	\$197
A2442N	24 x 42 x 29	70	73	3.80	\$500	\$165
A2436N	24 x 36 x 29	70	66	3.30	\$437	\$124
A2430N	24 x 30 x 29	70	59	3.60	\$403	\$124

Narrow end panels on both sides connects to 24"D worksurfaces; "D" islands or "P" islands with "T" and "H" bases; or at 90° angle to freestanding table(s). Grommet in worksurface. Shipped RTA (ready to assemble).

- Modesty Panel is 1" off of ground

SPACE SAVER CONNECTABLE TABLES - LEFT

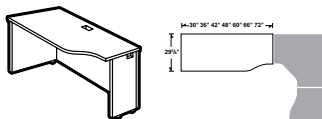

30" Deep Space Saver Connectable Table - LEFT

A3072LK	29.69 x 72 x 29	70	133	6	\$723	\$362
A3066LK	29.69 x 66 x 29	70	126	6	\$723	\$362
A3060LK	29.69 x 60 x 29	70	117	5.25	\$660	\$336
A3048LK	29.69 x 48 x 29	65	100	4.30	\$596	\$285
A3042LK	29.69 x 42 x 29	65	92	3.80	\$596	\$258
A3036LK	29.69 x 36 x 29	70	83	4.30	\$531	\$233
A3030LK	29.69 x 30 x 29	70	74	3.60	\$500	\$207

Full end panel on left. Narrow right end panel connects to 24"D 5-sided corner unit. Grommet in worksurface. Shipped RTA (ready to assemble).

- Modesty Panel is 1" off of ground
- Keyboard and pencil trays for use on units 42" and above

Required Specifications

Top finish
Base finish
Edge detail

Optional Specifications

Additional grommet position
HP laminate
Power block cut-out

Accessories

Power block
Keyboard tray
Pencil tray

A ADAPTABILITIES®

SPACE SAVER CONNECTABLE TABLES - LEFT

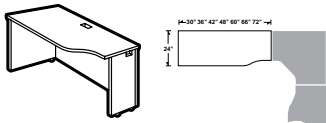

24" Deep Space Saver Connectable Table - LEFT

MODEL#	DIMENSIONS D x W x H	FREIGHT CLASS	WT/LBS.	CUBIC FT.	LIST PRICE	HP ADD
A2472LK	24 x 72 x 29	70	120	6	\$660	\$269
A2466LK	24 x 66 x 29	70	114	6	\$660	\$269
A2460LK	24 x 60 x 29	70	105	5.25	\$596	\$248
A2448LK	24 x 48 x 29	70	89	4.30	\$531	\$197
A2442LK	24 x 42 x 29	70	81	3.80	\$531	\$165
A2436LK	24 x 36 x 29	70	73	3.30	\$467	\$124
A2430LK	24 x 30 x 29	70	66	3.60	\$437	\$124

Full end panel on left. Narrow right end panel connects to 20"D 5-sided corner unit. Grommet in worksurface. Shipped RTA (ready to assemble).

- **Modesty Panel is 1" off of ground.**
- *Keyboard and pencil trays for use on units 42" and above*

SPACE SAVER CONNECTABLE TABLES - RIGHT

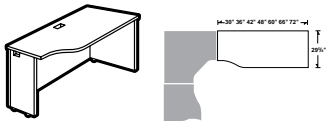

30" Deep Space Saver Connectable Table - RIGHT

A3072RK	29.69 x 72 x 29	70	133	6	\$723	\$362
A3066RK	29.69 x 66 x 29	70	126	6	\$723	\$362
A3060RK	29.69 x 60 x 29	70	117	5.25	\$660	\$336
A3048RK	29.69 x 48 x 29	65	100	4.30	\$596	\$285
A3042RK	29.69 x 42 x 29	65	91	3.80	\$596	\$258
A3036RK	29.69 x 36 x 29	70	83	4.30	\$531	\$233
A3030RK	29.69 x 30 x 29	70	74	3.60	\$500	\$207

Full end panel on right. Narrow right end panel connects to 24"D 5-sided corner unit. Grommet in worksurface. Shipped RTA (ready to assemble).

- **Modesty Panel is 1" off of ground**
- *Keyboard and pencil trays for use on units 42" and above*

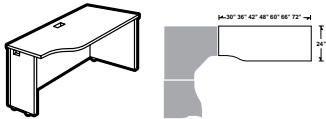

24" Deep Space Saver Connectable Table - RIGHT

A2472RK	24 x 72 x 29	70	120	6	\$660	\$269
A2466RK	24 x 66 x 29	70	114	6	\$660	\$269
A2460RK	24 x 60 x 29	70	105	5.25	\$596	\$248
A2448RK	30 x 48 x 29	70	89	4.30	\$531	\$197
A2442RK	24 x 42 x 29	70	81	3.80	\$531	\$165
A2436RK	24 x 36 x 29	70	73	3.30	\$467	\$124
A2430RK	24 x 30 x 29	70	66	3.60	\$437	\$124

Full end panel on right. Narrow right end panel connects to 20"D 5-sided corner unit. Grommet in worksurface. Shipped RTA (ready to assemble).

- **Modesty Panel is 1" off of ground.**
- *Keyboard and pencil trays for use on units 42" and above*

SPACE SAVER CONNECTABLE TABLES

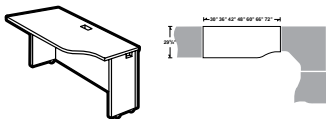

30" Deep Space Saver Connectable Table

A3072LN	29.69 x 72 x 29	70	125	6	\$700	\$362
A3066LN	29.69 x 66 x 29	70	117	6	\$700	\$362
A3060LN	29.69 x 60 x 29	70	108	5.25	\$637	\$336
A3048LN	29.69 x 48 x 29	70	91	4.30	\$573	\$285
A3042LN	29.69 x 42 x 29	70	83	3.80	\$573	\$258
A3036LN	29.69 x 36 x 29	70	74	3.30	\$510	\$233
A3030LN	29.69 x 30 x 29	70	66	3.60	\$476	\$207

Narrow end panels on both sides. Connects the **right end only to 24"D 5-sided corner unit.** Left end allows the continuation of additional connectable center or left connectable worksurface. Grommet in worksurface. Shipped RTA (ready to assemble).

- **Modesty Panel is 1" off of ground.**
- *Keyboard and pencil trays for use on units 42" and above*

Required Specifications

Top finish
Base finish
Edge detail

Optional Specifications

Additional grommet position
HP laminate
Power block cut-out

Accessories

Power block
Keyboard tray
Pencil tray

SPACE SAVER CONNECTABLE TABLES

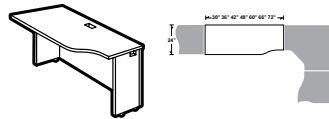

24" Deep Space Saver Connectable Table

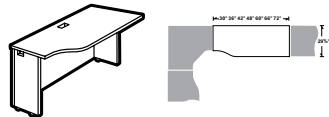

30" Deep Space Saver Connectable Table

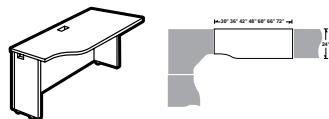

24" Deep Space Saver Connectable Table

MODEL#	DIMENSIONS	FREIGHT CLASS	WT./LBS.	CUBIC FT.	LIST PRICE	HP ADD
D x W x H						
A2472LN	24 x 72 x 29	70	112	6	\$637	\$269
A2466LN	24 x 66 x 29	70	105	6	\$637	\$269
A2460LN	24 x 60 x 29	70	96	5.25	\$573	\$248
A2448LN	24 x 48 x 29	70	81	4.30	\$510	\$197
A2442LN	24 x 42 x 29	70	73	3.80	\$510	\$165
A2436LN	24 x 36 x 29	70	65	3.30	\$446	\$124
A2430LN	24 x 30 x 29	70	58	3.60	\$414	\$124

Narrow end panels on both sides. Connects the **right end only to 20"D 5-sided corner unit**. Left end allows the continuation of additional connectable center or left connectable worksurface. Grommet in worksurface. Shipped RTA (ready to assemble).

- **Modesty Panel is 1" off of ground.**
- *Keyboard and pencil trays for use on units 42" and above*

A3072RN	29.69 x 72 x 29	70	125	6	\$700	\$362
A3066RN	29.69 x 66 x 29	70	117	6	\$700	\$362
A3060RN	29.69 x 60 x 29	70	108	5.25	\$637	\$336
A3048RN	29.69 x 48 x 29	70	91	4.30	\$573	\$285
A3042RN	29.69 x 42 x 29	70	83	3.80	\$573	\$258
A3036RN	29.69 x 36 x 29	70	74	3.30	\$510	\$233
A3030RN	29.69 x 30 x 29	70	66	3.60	\$476	\$207

Narrow end panels on both sides. Connects the **left end only to 24"D 5-sided corner unit**. Right end allows the continuation of additional connectable center or right connectable worksurface. Grommet in worksurface. Shipped RTA (ready to assemble).

- **Modesty Panel is 1" off of ground.**
- *Keyboard and pencil trays for use on units 42" and above*

A2472RN	24 x 72 x 29	70	112	6	\$637	\$269
A2466RN	24 x 66 x 29	70	105	6	\$637	\$269
A2460RN	24 x 60 x 29	70	96	5.25	\$573	\$248
A2448RN	24 x 48 x 29	70	81	4.30	\$510	\$197
A2442RN	24 x 42 x 29	70	72	3.80	\$510	\$165
A2436RN	24 x 36 x 29	70	59	3.30	\$446	\$124
A2430RN	24 x 30 x 29	85	53	3.60	\$414	\$124

Narrow end panels on both sides. Connects the **left end only to 20"D 5-sided corner unit**. Right end allows the continuation of additional connectable center or right connectable worksurface. Grommet in worksurface. Shipped RTA (ready to assemble).

- **Modesty Panel is 1" off of ground.**
- *Keyboard and pencil trays for use on units 42" and above*

"D" ISLANDS

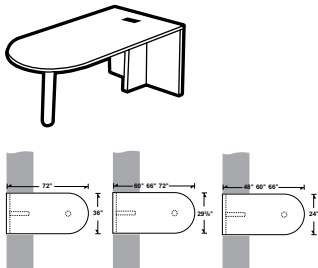

"D" Island - Full End Panel & Post (T-Base)

A3672FI	36 x 72 x 29	85	124	8.50	\$787	\$387
A3072FI	29.69 x 72 x 29	85	107	7.50	\$764	\$363
A3066FI	29.69 x 66 x 29	85	102	7.50	\$723	\$362
A3060FI	29.69 x 60 x 29	85	96	6.76	\$684	\$336
A2466FI	24 x 66 x 29	85	90	7.50	\$643	\$269
A2460FI	24 x 60 x 29	85	84	6.76	\$605	\$248
A2448FI	24 x 48 x 29	85	74	5.76	\$563	\$197

Connects to narrow end panel. Attaching hardware included. Not freestanding. Grommet in worksurface. Shipped RTA (ready to assemble).

- Post is shipped in a separate carton. Standard in Black; Silver is available at no charge, please specify **SI**.

Required Specifications

Top finish
Base finish
Edge detail

Optional Specifications

Additional grommet position
HP laminate
Power block cut-out

Accessories

Power block
Keyboard tray
Pencil tray

A ADAPTABILITIES®

"D" ISLANDS

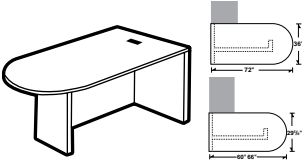

"D" Island LEFT - Full Modesty Panel (H-Base)

MODEL#	DIMENSIONS D x W x H	FREIGHT CLASS	WT/LBS.	CUBIC FT.	LIST PRICE	HP ADD
A3672FIL	36 x 72 x 29	70	139	7	\$723	\$387
A3066FIL	29.69 x 66 x 29	70	116	6	\$643	\$362
A3060FIL	29.69 x 60 x 29	70	106	5.25	\$605	\$336

Connects to the left side of a worksurface. Accommodates all 19" pedestals (freestanding, mobile and hanging pedestals). Grommet in worksurface. Shipped RTA (ready to assemble).

- Modesty Panel is 1" off of ground.

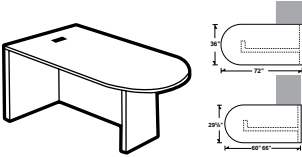

"D" Island RIGHT - Full Modesty Panel (H-Base)

A3672FIR	36 x 72 x 29	70	139	7	\$723	\$387
A3066FIR	29.69 x 66 x 29	70	116	6	\$643	\$362
A3060FIR	29.69 x 60 x 29	70	106	5.25	\$605	\$336

Connects to the right side of a worksurface. Accommodates all 19" pedestals (freestanding, mobile and hanging pedestals). Grommet in worksurface. Shipped RTA (ready to assemble).

- Modesty Panel is 1" off of ground.

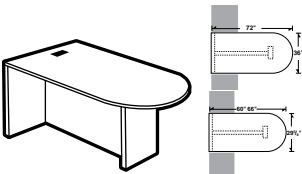

"D" Island Center - Full Modesty Panel (H-Base)

A3672FIC	36 x 72 x 29	70	139	7	\$723	\$387
A3066FIC	29.69 x 66 x 29	70	116	6	\$643	\$362
A3060FIC	29.69 x 60 x 29	70	106	5.25	\$605	\$336

Connects in between two worksurfaces. Will not accommodate pedestals. Grommet in worksurface. Shipped RTA (ready to assemble).

- Modesty Panel is 1" off of ground.

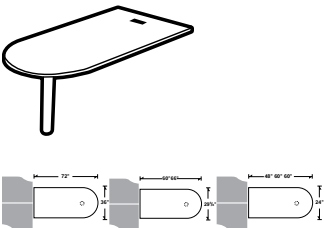

Attachable "D" Island with Post

A3672I	36 x 72 x 29	92.5	88	8.50	\$684	\$387
A3066I	29.69 x 66 x 29	100	71	7.50	\$605	\$362
A3060I	29.69 x 60 x 29	100	65	6.76	\$563	\$336
A2466I	24 x 66 x 29	100	63	7.50	\$524	\$269
A2460I	24 x 60 x 29	100	57	6.76	\$486	\$248
A2448I	24 x 48 x 29	100	47	5.76	\$446	\$197

Attaches to edge of worksurfaces. Attaching hardware included. Grommet in worksurface. Shipped RTA (ready to assemble).

- Post is shipped in a separate carton. Standard in Black; Silver is available at no charge, please specify **SIL**.

EXTENDED CORNER ISLANDS

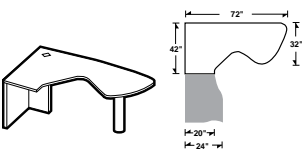

Extended Corner Island - RIGHT

A4272EIR	42-32 x 72 x 29	100	104	11.50	\$944	\$516
----------	-----------------	-----	-----	-------	--------------	--------------

Extended island worksurface on right. Connects to 20"D returns or 24"D space saver connectables on the left. **Not freestanding.** Predrilled to accept MPOKST2 or 22"-28" keyboard trays. Grommet in worksurface. Shipped RTA (ready to assemble).

- Post is shipped in separate carton. Standard in Black; Silver is available at no charge, please specify **SI**.

Required Specifications

Top finish
Base finish
Edge detail
Post finish*

Optional Specifications

Additional grommet position
HP laminate
Power block cut-out

Accessories

Power block
Keyboard tray
Pencil tray

EXTENDED CORNER ISLANDS

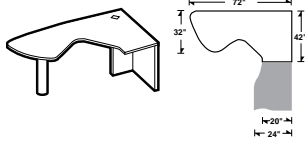

Extended Corner Island - LEFT

MODEL# DIMENSIONS FREIGHT CLASS WT/LBS. CUBIC FT. LIST PRICE HP ADD

MODEL#	D x W x H	FREIGHT CLASS	WT/LBS.	CUBIC FT.	LIST PRICE	HP ADD
A4272EIL	42-32 x 72 x 29	100	104	11.50	\$944	\$516

Extended island worksurface on left. Connects to 20"D returns or 24"D space saver connectables on the right. **Not freestanding.** Predrilled to accept MPOKST2 or 22"-28" keyboard trays. Grommet in worksurface. Shipped RTA (ready to assemble).

- Post is shipped in separate carton. Standard in Black; Silver is available at no charge, please specify **SI**.

"P" ISLANDS

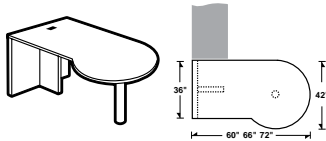

"P" Island LEFT - Full End Panel & Post (T-Base)

A3672FPL	36-42 x 72 x 29	85	128	9.26	\$924	\$516
A3666FPL	36-42 x 66 x 29	85	122	8.76	\$844	\$516
A3660FPL	36-42 x 60 x 29	85	116	8	\$803	\$439

Connects to left side of worksurface. Attaching hardware included. **Not freestanding.** Grommet in worksurface. Shipped RTA (ready to assemble).

- Post is shipped in separate carton. Standard in Black; Silver is available at no charge, please specify **SI**.

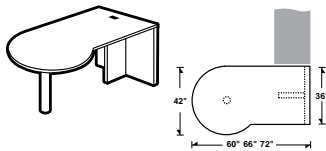

"P" Island RIGHT - Full End Panel & Post (T-Base)

A3672FPR	36-42 x 72 x 29	85	128	9.26	\$924	\$516
A3666FPR	36-42 x 66 x 29	85	122	8.76	\$844	\$516
A3660FPR	36-42 x 60 x 29	85	116	8	\$803	\$439

Connects to right side of worksurface. Attaching hardware included. **Not freestanding.** Grommet in worksurface. Shipped RTA (ready to assemble).

- Post is shipped in separate carton. Standard in Black; Silver is available at no charge, please specify **SI**.

"P" ISLANDS WITH FULL MODESTY PANEL

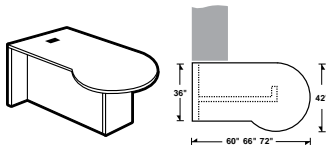

"P" Island LEFT - Full Modesty Panel (H-Base)

A3672PL	36-42 x 72 x 29	70	143	7.75	\$844	\$516
A3666PL	36-42 x 66 x 29	70	136	7.25	\$764	\$516
A3660PL	36-42 x 60 x 29	70	126	6.50	\$723	\$439

Connects to the left side of a worksurface. Accommodates all 19" pedestals (freestanding, mobile and hanging pedestals). Grommet in worksurface. Shipped RTA (ready to assemble).

- Modesty Panel is 1" off of ground.

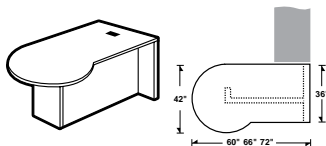

"P" Island RIGHT - Full Modesty Panel (H-Base)

A3672PR	36-42 x 72 x 29	70	143	7.75	\$844	\$516
A3666PR	36-42 x 66 x 29	70	136	7.25	\$764	\$516
A3660PR	36-42 x 60 x 29	70	126	6.50	\$723	\$439

Connects to the right side of a worksurface. Accommodates all 19" pedestals (freestanding, mobile and hanging pedestals). Grommet in worksurface. Shipped RTA (ready to assemble).

- Modesty Panel is 1" off of ground.

Required Specifications

Top finish
Base finish
Edge detail
Post finish*

Optional Specifications

Additional grommet position
HP laminate
Power block cut-out

Accessories

Power block
Keyboard tray
Pencil tray

A ADAPTABILITIES®

"P" ISLANDS (ATTACHABLE)

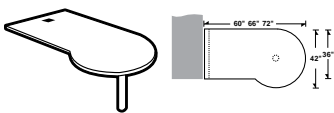

"P" Island LEFT with Post

MODEL#	DIMENSIONS D x W x H	FREIGHT CLASS	WT/LBS.	CUBIC FT.	LIST PRICE	HP ADD
A3672IPL	36-42 x 72 x 29	100	92	9.26	\$803	\$516
A3666IPL	36-42 x 66 x 29	100	86	8.76	\$723	\$516
A3660IPL	36-42 x 60 x 29	92.5	80	8	\$684	\$439

Attaches to edge of worksurfaces. Attaching hardware included. Grommet in worksurface. Shipped RTA (ready to assemble).
 • Post is shipped in separate carton. Standard in Black; Silver is available at no charge, please specify **SI**.

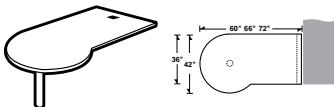

"P" Island RIGHT with Post

A3672IPR	36-42 x 72 x 29	100	92	9.26	\$803	\$516
A3666IPR	36-42 x 66 x 29	100	86	8.76	\$723	\$516
A3660IPR	36-42 x 60 x 29	92.5	80	8	\$684	\$439

Attaches to edge of worksurfaces. Attaching hardware included. Grommet in worksurface. Shipped RTA (ready to assemble).
 • Post is shipped in separate carton. Standard in Black; Silver is available at no charge, please specify **SI**.

RADIUS SPANNER ISLANDS

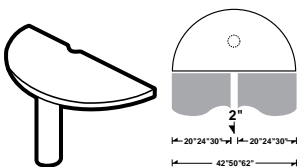

Radius Spanner Island with Panel Cut-Out

A62RS	31 x 62 x 29	100	59	6.76	\$740	\$310
A50RS	25 x 50 x 29	125	46	5.76	\$643	\$258
A42RS	21 x 42 x 29	125	41	5.26	\$582	\$207

Used to connect two back-to-back units of same depth with a panel. Includes monopost. Requires "L" bracket (model **MLB90**) for connection to full end panels. Shipped RTA (ready to assemble).

- MLB90 must be ordered separately - see page 517.
- Post is shipped in separate carton. Standard in Black; Silver is available at no charge, please specify **SI**.
- **Cannot accept keyboard trays or pencil tray**

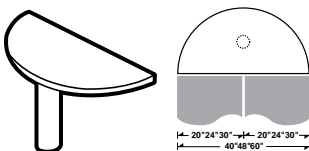

Radius Spanner Island

A60RS	29.69 x 60 x 29	100	56	5.76	\$740	\$258
A48RS	24 x 48 x 29	125	43	5.76	\$643	\$207
A40RS	20 x 40 x 29	125	40	5.26	\$582	\$207

Used to connect two back-to-back units of same depth. Includes monopost. Requires "L" bracket (model **MLB90**) for connection to full end panels. Shipped RTA (ready to assemble).

- MLB90 must be ordered separately - see page 517.
- Post is shipped in separate carton. Standard in Black; Silver is available at no charge, please specify **SI**.
- **Cannot accept keyboard trays or pencil tray**

RECEPTION DESKS

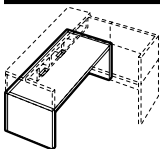

Lower Desk Unit

A3072RD	29.69 x 72 x 29	70	149	7	\$803	\$362
---------	-----------------	----	-----	---	--------------	--------------

No pedestals. Two grommets in worksurface. Shipped RTA (ready to assemble).
 • Cannot be used with Divide.

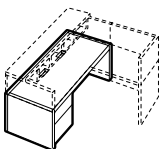

Single Pedestal Lower Desk Unit - LEFT

A3072RDL	29.69 x 72 x 29	150	222	43.75	\$1163	\$362
A3060RDL	30 x 60 x 29	150	201	36	\$1003	\$336

Box/file pedestal on **left** with lock. Two grommets in worksurface.
 • Cannot be used with Divide.

Required Specifications

Top finish
 Base finish (not radius spanner islands)
 Post finish**
 Edge detail

Optional Specifications

Additional grommet position*
 HP laminate*
 Power block cut-out*

Accessories

Power block*
 Keyboard tray*
 Pencil tray*

RECEPTION DESKS

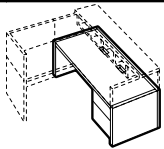

Single Pedestal Lower Desk Unit - RIGHT

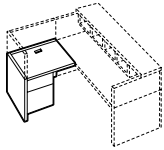

Reception Return - LEFT

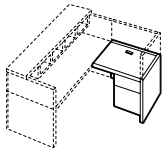

Reception Return - RIGHT



Reception Return - LEFT



Reception Return - RIGHT

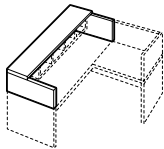

Transaction Counter

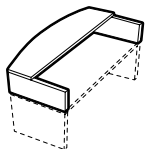

Bow Front Transaction Counter

MODEL#	DIMENSIONS	FREIGHT CLASS	WT/LBS.	CUBIC FT.	LIST PRICE	HP ADD
--------	------------	---------------	---------	-----------	------------	--------

D x W x H

A3072RDR	29.69 x 72 x 29	150	222	43.75	\$1163	\$362
A3060RDR	30 x 60 x 29	150	201	36	\$1003	\$336

Box/file pedestal on **right** with lock. Two grommets in worksurface.

- Cannot be used with Divide.

A2442RRL	24 x 42 x 29	125	131	21.25	\$764	\$165
----------	--------------	-----	-----	-------	--------------	--------------

Box/file pedestal on **left** with lock. Grommet in worksurface.

- Cannot be used with Divide.
- **Cannot accept keyboard trays or pencil tray**

A2442RRR	24 x 42 x 29	125	131	21.25	\$764	\$165
----------	--------------	-----	-----	-------	--------------	--------------

Box/file pedestal on **right** with lock. Grommet in worksurface.

- Cannot be used with Divide.
- **Cannot accept keyboard trays or pencil tray**

A2442KRL	24 x 42 x 29	70	83	3.80	\$563	\$165
----------	--------------	----	----	------	--------------	--------------

No pedestal. Grommet in worksurface.

- Cannot be used with Divide.

A2442KRR	24 x 42 x 29	70	83	3.80	\$563	\$165
----------	--------------	----	----	------	--------------	--------------

No pedestal. Grommet in worksurface.

- Cannot be used with Divide.

A3072URD	29.69 x 72 x 13.75	70	67	4.30	\$486	\$207
A3060URD	30 x 60 x 13.75	65	59	2.60	\$456	\$207

For main reception desk. Shipped RTA (ready to assemble). Depth of reception top is 12".

- Reception top units are to be used only with lower reception units. Tops have mini-fix fasteners to attach the reception top units.

A3072URB	29.69-36 x 72 x 13.75	70	72	4.30	\$659	\$258
----------	-----------------------	----	----	------	--------------	--------------

For main reception desk. To be used on A3072RD, A3072RDL or A3072RDR. Shipped RTA (ready to assemble). Depth of reception bow top is 12-15".

- Reception top units are to be used only with desks listed. Tops have mini-fix fasteners to attach the reception top units.

Required Specifications

Top finish
Base finish
Edge detail

Optional Specifications

Additional grommet position*
HP laminate*
Power block cut-out*

Accessories

Power block*
Keyboard tray*
Pencil tray*

RECEPTION DESKS

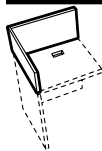

Return Screen Unit - LEFT

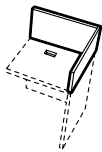

Return Screen Unit - RIGHT

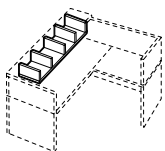

Desk Top Organizer

MODEL#	DIMENSIONS	FREIGHT CLASS	WT./LBS.	CUBIC FT.	LIST PRICE	HP ADD
--------	------------	---------------	----------	-----------	------------	--------

D x W x H

A2442URL	24 x 42 x 12.75	85	27	2	\$245	N/A
----------	-----------------	----	----	---	-------	-----

To be used on top of left reception return (A2442RRL/KRL). Shipped RTA (ready to assemble).

- Reception top units are to be used only with returns listed. Tops have mini-fix fasteners to attach the reception top units.

A2442URR	24 x 42 x 12.75	85	27	2	\$245	N/A
----------	-----------------	----	----	---	-------	-----

To be used on top of right reception return (A2442RRR/KRR). Shipped RTA (ready to assemble).

- Reception top units are to be used only with returns listed. Tops have mini-fix fasteners to attach the reception top units.

A1172ORD	11 x 52 x 6	100	22	2.60	\$164	N/A
----------	-------------	-----	----	------	-------	-----

To be used under transaction counter. Black (BK) finish only. Shipped RTA (ready to assemble).

WALL/PANEL MOUNT OVERSTORAGE UNITS

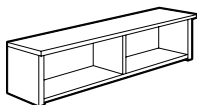

Overstorage Unit

A00S60	15 x 60 x 16	70	86	5.25	\$603	N/A
A00S48	15 x 48 x 16	70	70	4.30	\$493	N/A
A00S42	15 x 42 x 16	70	62	3.80	\$486	N/A
A00S36	15 x 36 x 16	70	56	3.30	\$429	N/A
A00S30	15 x 30 x 16	70	48	3	\$401	N/A

Standard with pre-mounted "J" bracket for wall mount applications. Can be hung on GPS II panels with optional **ABR1** hanging bracket. One fixed shelf, closed back. Uses standard Adaptabilities Hutch Doors. Shipped RTA (ready to assemble).

- **NOTE:** Care should be taken to mount the units. Units should be mounted to wall studs using correct fasteners. Failure to do so may result in collapse of the unit and subsequent personal injury. **Mounting hardware not included.** Mounting hardware used should be based on wall material. Consult an installation professional for proper wall mounting.

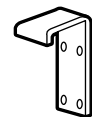

Hanging Bracket

ABR1	--	70	1	.01	\$70	N/A
------	----	----	---	-----	------	-----

Used to hang overstorage unit on GPS II Panels. Accommodates maximum 1 1/2" thick panels. Set includes two hanging brackets, spacing plates and screws.

- Additional hardware and panels may be needed for stability. Floor mounts are required for panel installation.

OPEN HUTCHES

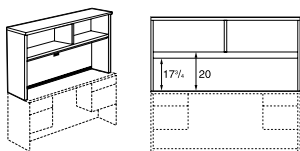

Open Hutch with Closed Back

A72HOCB	15 x 72 x 36	125	175	28.25	\$865	N/A
A71HOCB	15 x 71.69 x 36	125	175	28.25	\$865	N/A
A66HOCB	15 x 66 x 36	125	164	26	\$827	N/A
A60HOCB	15 x 60 x 36	125	151	23.75	\$764	N/A

One fixed shelf and fixed shelf divider. Closed back features a grommet and flexible sweep for wire management. All hutches shipped pre-assembled. ***A71HOCB** for use when spanning 30" x 60/66" SPL/R and 20/24" x 42" FL/FR/L4/R4.

- Clearance from worksurface to valance is 17 3/4"; clearance from worksurface to hutch doors is 20".
- Woodgrain runs horizontal on both the upper and lower back panels.

Required Specifications

Top finish
Base finish*
Edge detail*

Optional Specifications

Doors*

PIGEON-HOLE STORAGE

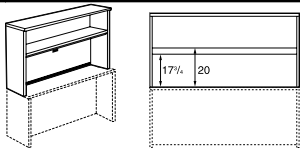

Open Hutch with Closed Back

MODEL#	DIMENSIONS D x W x H	FREIGHT CLASS	WT./LBS.	CUBIC FT.	LIST PRICE	HP ADD
A48HOCB	15 x 48 x 36	125	124	19	\$605	N/A
A42HOCB	15 x 42 x 36	125	111	16.75	\$605	N/A
A36HOCB	15 x 36 x 36	125	99	14.50	\$524	N/A
A30HOCB	15 x 30 x 36	125	88	12.25	\$486	N/A

One fixed shelf. Closed back features a grommet and flexible sweep for wire management. All hutches shipped pre-assembled.

- Clearance from worksurface to valance is 17 3/4"; clearance from worksurface to hutch doors is 20".
- Woodgrain runs horizontal on both the upper and lower back panels.

PIGEON-HOLE STORAGE

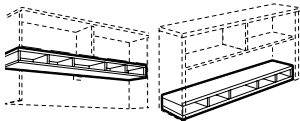

Horizontal Pigeon-Hole Storage

AHS72	11.25 x 70 x 5.62	85	41	3	\$508	N/A
AHS71	11.25 x 71 x 5.62	70	43.50	2.30	\$508	N/A
AHS66	11.25 x 64 x 5.62	85	38	2.80	\$508	N/A
AHS60	11.25 x 58 x 5.62	85	35	2.50	\$416	N/A
AHS48	11.25 x 46 x 5.62	85	28	2	\$306	N/A
AHS42	11.25 x 40 x 5.62	85	24	2	\$306	N/A
AHS36	11.25 x 34 x 5.62	92.5	22	2	\$250	N/A

For additional storage. Can be **top** or **bottom** mounted. For use inside hutch. Shipped RTA (ready to assemble).

- **Cannot be used on AODS and COOS Overstorage Units.**
- Black finish is standard. Brushed Cobalt is available at no charge, please specify as **BRC**.

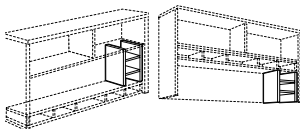

Vertical Pigeon-Hole Storage

AVS14	11.25 x 13.37 x 14.37	85	13	.90	\$317	N/A
-------	-----------------------	----	----	-----	--------------	-----

For use in conjunction with the Horizontal Pigeon-Hole Storage. Can be used under or over horizontal unit. Shipped RTA (ready to assemble).

- Black finish is standard. Brushed Cobalt is available at no charge, please specify as **BRC**.

CORNER HUTCHES

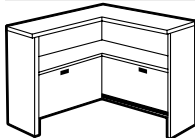

Corner Hutch with Closed Back

A42CH	15 x 42 x 36	65	144	6.25	\$1020	N/A
A36CH	15 x 36 x 36	65	125	4.80	\$859	N/A

One fixed shelf. Closed back features a grommet in both back panels and flexible sweep for wire management. Shipped RTA (ready to assemble).

- Woodgrain runs horizontal on both the upper and lower back panels.

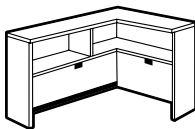

RIGHT Corner Hutch with Closed Back

A3672CHR	15 x 36-72 x 36	65	186	7	\$1123	N/A
A3666CHR	15 x 36-66 x 36	65	177	7	\$1082	N/A

One fixed shelf and shelf divider on left side. Closed back features a grommet in both back panels and flexible sweep for wire management on the left side. Shipped RTA (ready to assemble).

- Woodgrain runs horizontal on both the upper and lower back panels.

Required Specifications

- Top finish
- Base finish*
- Edge detail*

CORNER HUTCHES

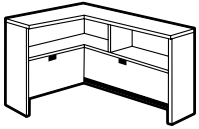

LEFT Corner Hutch with Closed Back

MODEL#	DIMENSIONS	FREIGHT CLASS	WT/LBS.	CUBIC FT.	LIST PRICE	HP ADD
--------	------------	---------------	---------	-----------	------------	--------

D x W x H

A3672CHL	15 x 36-72 x 36	65	186	7.25	\$1123	N/A
A3666CHL	15 x 36-66 x 36	65	177	7.25	\$1082	N/A

One fixed shelf and shelf divider on right side. Closed back features a grommet in both back panels and flexible sweep for wire management on the right side. Shipped RTA (ready to assemble).

- Woodgrain runs horizontal on both the upper and lower back panels.

HUTCH DOORS

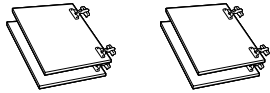

Four-Door Kit

ADOOR72	.69 x 17.75 x 15	85	25	1.80	\$317	N/A
ADOOR71	.69 x 17.12 x 15	85	25	1.80	\$317	N/A
ADOOR66	.69 x 16.75 x 15	85	24	1.80	\$317	N/A
ADOOR60	.69 x 14.75 x 15	85	22	1.80	\$317	N/A

For use on 72", 71", 66" and 60"W straight hutches. Hinges included. Locks available, ADD \$95.00 each lock. Doors for units 60" wide or more require two locks.

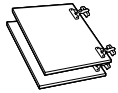

Two-Door Kit

ADOOR48	.69 x 23.5 x 15	92.5	18	1.80	\$205	N/A
ADOOR42	.69 x 20.5 x 15	100	17	1.80	\$205	N/A
ADOOR36	.69 x 17.5 x 15	100	15	1.80	\$205	N/A
ADOOR30	.69 x 14.5 x 15	125	13	1.80	\$205	N/A

For use on 48", 42" 36" and 30"W straight hutches. Hinges included. Locks available, ADD \$95.00 each lock. Doors for units 48" wide or less require one lock.

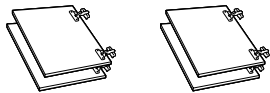

Corner Hutch Four-Door Kit

ADOOR72C	.69 x 0 x 15	70	27	1.80	\$403	N/A
ADOOR66C	.69 x 0 x 15	85	25	1.80	\$367	N/A

For use on 72" and 66"W corner hutches. Hinges included. Locks not available on corner hutch doors.

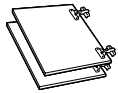

Corner Hutch Two-Door Kit

ADOOR42C	.69 x 26.5 x 15	92.5	20	1.80	\$349	N/A
ADOOR36C	.69 x 21.5 x 15	100	17	1.80	\$228	N/A

For use on 42" and 36"W corner hutches. Hinges included. Locks not available on corner hutch doors.

Required Specifications

Top finish
Base finish (only hutches)
Edge detail*

Optional Specifications

Doors*
Handles*
Glazed door*

TACKBOARDS FOR HUTCHES

MODEL# DIMENSIONS FREIGHT CLASS WT./LBS. CUBIC FT. FABRIC GRADE LIST PRICE

D x W x H

TACKBOARD Notes: Tackboards can be upholstered in all of the following fabrics:

Grade 1: Agate II, Drama, Jenny, Pebbles, Quilt, Sprinkle, Station, Urban

Grade 2: Couture, Crescent, Cumulus, Imprint, Lola, Match, Oxygen, Quantum, Renewal, Replay, Silhouette

Grade 3: Brinx, Mariposa

Grade 4: Accent

Grade 5: Meander, Tracery, Universe

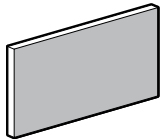

Tackboard

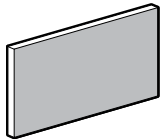

Tackboard

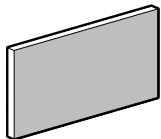

Tackboard

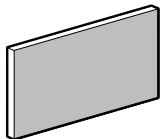

Tackboard

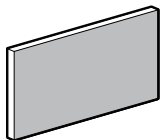

Tackboard

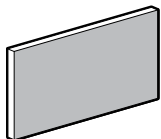

Tackboard

ATB7016	1 x 70 x 15	92.5	7	.65	1	\$294
					2	\$350
					3	\$390
					4	\$457
					5	\$526

For use on **A72HOCB** straight hutch. Includes mounting screws and covers.

ATB6916	1 x 69.5 x 15	92.5	7	.65	1	\$294
					2	\$350
					3	\$391
					4	\$457
					5	\$526

For use on **A71HOCB** straight hutch. Includes mounting screws and covers.

ATB6416	1 x 64 x 15	100	6.40	.65	1	\$289
					2	\$338
					3	\$377
					4	\$433
					5	\$498

For use on **A66HOCB** straight hutch. Includes mounting screws and covers.

ATB5816	1 x 58 x 15	92.5	5.80	.54	1	\$283
					2	\$332
					3	\$368
					4	\$428
					5	\$493

For use on **A60HOCB** straight hutch. Includes mounting screws and covers.

ATB4616	1 x 46 x 15	92.5	4.60	.43	1	\$196
					2	\$234
					3	\$262
					4	\$306
					5	\$352

For use on **A48HOCB** straight hutch. Includes mounting screws and covers.

ATB4016	1 x 40 x 15	100	4	.42	1	\$190
					2	\$222
					3	\$247
					4	\$285
					5	\$328

For use on **A42HOCB** straight hutch. Includes mounting screws and covers.

Required Specifications

Fabric

TACKBOARDS FOR HUTCHES

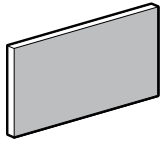

Tackboard

MODEL#	DIMENSIONS D x W x H	FREIGHT CLASS	WT/LBS.	CUBIC FT.	FABRIC GRADE	LIST PRICE
ATB3416	1 x 34 x 15	150	3.40	.85	1	\$184
					2	\$216
					3	\$240
					4	\$275
					5	\$317

For use on **A36HOCB** straight hutch. Includes mounting screws and covers.

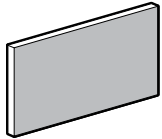

Tackboard

ATB2816	1 x 28 x 15	125	2.80	.43	1	\$178
					2	\$203
					3	\$222
					4	\$250
					5	\$288

For use on **A30HOCB** straight hutch. Includes mounting screws and covers.

TACKBOARDS FOR CORNER HUTCHES

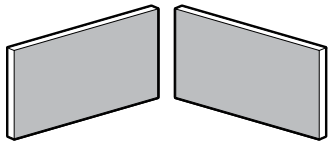

Tackboard

ATB72CH	1 x 33-72 x 15 70 w x 15¾ h	125	9.94	1.30	1	\$455
					2	\$512
					3	\$553
					4	\$619
					5	\$712

For use on **A3672CHR/L corner** hutch. Includes mounting screws and covers.

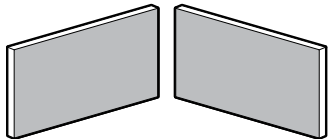

Tackboard

ATB66CH	1 x 33-64 x 15 64 w x 15¾ h	125	9.40	1.30	1	\$448
					2	\$497
					3	\$537
					4	\$593
					5	\$682

For use on **A3666CHR/L corner** hutch. Includes mounting screws and covers.

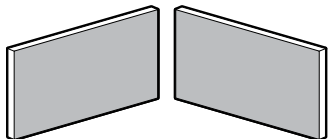

Tackboard

ATB42CH	1 x 39-40 x 15	100	7.70	.85	1	\$357
					2	\$391
					3	\$423
					4	\$467
					5	\$538

For use on **A42CH corner** hutch. Includes mounting screws and covers.

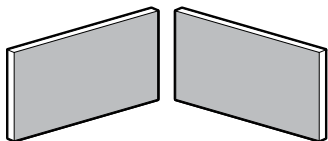

Tackboard

ATB36CH	1 x 33-34 x 15	125	6.60	.85	1	\$343
					2	\$376
					3	\$401
					4	\$450
					5	\$518

For use on **A36CH corner** hutch. Includes mounting screws and covers.

Required Specifications

Fabric - Tackboards
Finish - Transaction Top

WALL MOUNTED TACKBOARDS

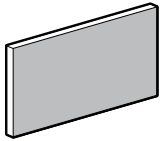

Wall Mounted Tackboard

MODEL#	DIMENSIONS	FREIGHT CLASS	WT/LBS.	CUBIC FT.	FABRIC GRADE	LIST PRICE
AWHT3019	1.25 x 30 x 19	125	6.30	1		
					D x W x H	
					1	\$228
					2	\$262
					3	\$302
4	\$347					
5	\$399					

For use under **A00S30** overstorage unit. Standard with pre-mounted "J" bracket for wall mount applications. There will be a 1.75" clearance between the top of the tackboard and bottom of the overhead, and a .25" clearance between the bottom of the tackboard and the worksurface.

• **NOTE:** Care should be taken to mount the units. Units should be mounted to wall studs using correct fasteners. Failure to do so may result in collapse of the unit and subsequent personal injury. **Mounting hardware not included.** Mounting hardware used should be based on wall material. Consult an installation professional for proper wall mounting.

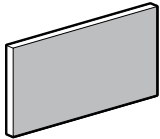

Wall Mounted Tackboard

AWHT3619	1.25 x 36 x 19	125	7.60	1		
					1	\$253
					2	\$292
					3	\$335
					4	\$385
5	\$443					

For use under **A00S36** overstorage unit. Standard with pre-mounted "J" bracket for wall mount applications. There will be a 1.75" clearance between the top of the tackboard and bottom of the overhead, and a .25" clearance between the bottom of the tackboard and the worksurface.

• **NOTE:** Care should be taken to mount the units. Units should be mounted to wall studs using correct fasteners. Failure to do so may result in collapse of the unit and subsequent personal injury. **Mounting hardware not included.** Mounting hardware used should be based on wall material. Consult an installation professional for proper wall mounting.

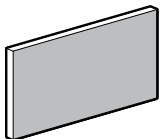

Wall Mounted Tackboard

AWHT4219	1.25 x 42 x 19	100	8.90	1		
					1	\$295
					2	\$339
					3	\$390
					4	\$448
5	\$515					

For use under **A00S42** overstorage unit. Standard with pre-mounted "J" bracket for wall mount applications. There will be a 1.75" clearance between the top of the tackboard and bottom of the overhead, and a .25" clearance between the bottom of the tackboard and the worksurface.

• **NOTE:** Care should be taken to mount the units. Units should be mounted to wall studs using correct fasteners. Failure to do so may result in collapse of the unit and subsequent personal injury. **Mounting hardware not included.** Mounting hardware used should be based on wall material. Consult an installation professional for proper wall mounting.

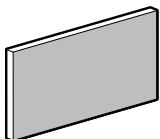

Wall Mounted Tackboard

AWHT4819	1.25 x 48 x 19	92.5	10.10	1		
					1	\$320
					2	\$368
					3	\$423
					4	\$487
5	\$560					

For use under **A00S48** overstorage unit. Standard with pre-mounted "J" bracket for wall mount applications. There will be a 1.75" clearance between the top of the tackboard and bottom of the overhead, and a .25" clearance between the bottom of the tackboard and the worksurface.

• **NOTE:** Care should be taken to mount the units. Units should be mounted to wall studs using correct fasteners. Failure to do so may result in collapse of the unit and subsequent personal injury. **Mounting hardware not included.** Mounting hardware used should be based on wall material. Consult an installation professional for proper wall mounting.

Required Specifications

Fabric

A ADAPTABILITIES®

WALL MOUNTED TACKBOARDS

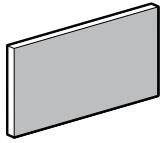

Wall Mounted Tackboard

MODEL#	DIMENSIONS D x W x H	FREIGHT CLASS	WT/LBS.	CUBIC FT.	FABRIC GRADE	LIST PRICE
AWHT6019	1.25 x 60 x 19	125	12.70	1.80	1	\$397
					2	\$457
					3	\$525
					4	\$604
					5	\$694

For use under **A00S60** overstorage unit. Standard with pre-mounted "J" bracket for wall mount applications. There will be a 1.75" clearance between the top of the tackboard and bottom of the overhead, and a .25" clearance between the bottom of the tackboard and the worksurface.

- **NOTE:** Care should be taken to mount the units. Units should be mounted to wall studs using correct fasteners. Failure to do so may result in collapse of the unit and subsequent personal injury. **Mounting hardware not included.** Mounting hardware used should be based on wall material. Consult an installation professional for proper wall mounting.

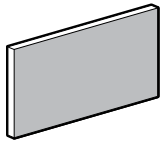

Wall Mounted Tackboard

AWHT6619	1.25 x 66 x 19	125	13.90	1.80	1	\$421
					2	\$485
					3	\$557
					4	\$641
					5	\$737

For use under **multiple** Adaptabilities wall mounted overstorage units. Standard with pre-mounted "J" bracket for wall mount applications. There will be a 1.75" clearance between the top of the tackboard and bottom of the overhead, and a .25" clearance between the bottom of the tackboard and the worksurface.

- **NOTE:** Care should be taken to mount the units. Units should be mounted to wall studs using correct fasteners. Failure to do so may result in collapse of the unit and subsequent personal injury. **Mounting hardware not included.** Mounting hardware used should be based on wall material. Consult an installation professional for proper wall mounting.

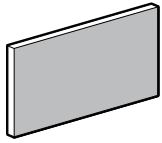

Wall Mounted Tackboard

AWHT7219	1.25 x 72 x 19	100	15.20	1.80	1	\$463
					2	\$532
					3	\$612
					4	\$704
					5	\$809

For use under **multiple** Adaptabilities wall mounted overstorage units. Standard with pre-mounted "J" bracket for wall mount applications. There will be a 1.75" clearance between the top of the tackboard and bottom of the overhead, and a .25" clearance between the bottom of the tackboard and the worksurface.

- **NOTE:** Care should be taken to mount the units. Units should be mounted to wall studs using correct fasteners. Failure to do so may result in collapse of the unit and subsequent personal injury. **Mounting hardware not included.** Mounting hardware used should be based on wall material. Consult an installation professional for proper wall mounting.

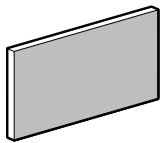

Wall Mounted Tackboard

AWHT7819	1.25 x 78 x 19	100	16.50	1.80	1	\$488
					2	\$561
					3	\$645
					4	\$742
					5	\$853

For use under **multiple** Adaptabilities wall mounted overstorage units. Standard with pre-mounted "J" bracket for wall mount applications. There will be a 1.75" clearance between the top of the tackboard and bottom of the overhead, and a .25" clearance between the bottom of the tackboard and the worksurface.

- **NOTE:** Care should be taken to mount the units. Units should be mounted to wall studs using correct fasteners. Failure to do so may result in collapse of the unit and subsequent personal injury. **Mounting hardware not included.** Mounting hardware used should be based on wall material. Consult an installation professional for proper wall mounting.

Required Specifications

Fabric

ACCESSORY PIECES

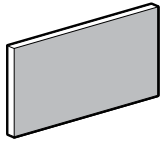

Wall Mounted Tackboard

MODEL#	DIMENSIONS D x W x H	FREIGHT CLASS	WT./LBS.	CUBIC FT.	LIST PRICE	HP ADD
AWHT8419	1.25 x 84 x 19	100	17.70	1.80	1	\$529
					2	\$609
					3	\$700
					4	\$805
					5	\$926

For use under **multiple** Adaptabilities wall mounted overstorage units. Standard with pre-mounted "J" bracket for wall mount applications. There will be a 1.75" clearance between the top of the tackboard and bottom of the overhead, and a .25" clearance between the bottom of the tackboard and the worksurface.

- **NOTE:** Care should be taken to mount the units. Units should be mounted to wall studs using correct fasteners. Failure to do so may result in collapse of the unit and subsequent personal injury. **Mounting hardware not included.** Mounting hardware used should be based on wall material. Consult an installation professional for proper wall mounting.

ACCESSORY PIECES



Mixed Drawer Cabinet - LEFT

A2036MDL	20 x 36 x 29	92.5	162	15.50	\$1528	\$124
A2436MDL	24 x 36 x 29	100	176	18.25	\$1552	\$124

Two box drawers on **right**, one file drawer on **left** and one lateral file drawer on bottom. File on lateral file drawers locking. 1 pencil tray. Front-to-back filing bars.

- Black handles are standard. Silver is available at no charge, please specify as **SI**.
- To comply with ANSI/BIFMA stability tests, the Lateral File Counter Weight Kit (model LFCWKIT36 - pg. 40) MUST be used.
- *File drawer construction is for accommodating hanging files NOT for stacking materials on the drawer bottom.*



Mixed Drawer Cabinet - RIGHT

A2036MDR	20 x 36 x 29	92.5	162	15.50	\$1528	\$124
A2436MDR	24 x 36 x 29	100	176	18.25	\$1552	\$124

Two box drawers on **left**, one file drawer on **right** and one lateral file drawer on bottom. File on lateral file drawers locking. 1 pencil tray. Front-to-back filing bars.

- Black handles are standard. Silver is available at no charge, please specify as **SI**.
- To comply with ANSI/BIFMA stability tests, the Lateral File Counter Weight Kit (model LFCWKIT36 - pg. 40) MUST be used.
- *File drawer construction is for accommodating hanging files NOT for stacking materials on the drawer bottom.*



Mixed Drawer Cabinet Shell - LEFT

A2036MDLS	19.25 x 36 x 28	100	137	15	\$1490	N/A
A2436MDLS	23.25 x 36 x 28	100	150	18	\$1515	N/A

For use **under 29"H limited single pedestal desks, workstations or limited single pedestal credenzas. Unfinished top, no back.** Two box drawers on **right**, one file drawer on **left** and one lateral file drawer on bottom. File and lateral file drawers locking. 1 pencil tray. Front-to-back filing bars.

- Black handles are standard. Silver is available at no charge, please specify as **SI**.
- *File drawer construction is for accommodating hanging files NOT for stacking materials on the drawer bottom.*
- *For 24" deep worksurfaces, order **A2436MDLS**. For 20" deep worksurfaces, order **A2036MDLS**.*

Required Specifications

Fabric*
Top finish**
Handle finish
Base finish

Optional Specifications

Edge
Key # (not tackboards)

ACCESSORY PIECES



Mixed Drawer Cabinet Shell - RIGHT

MODEL#	DIMENSIONS D x W x H	FREIGHT CLASS	WT/LBS.	CUBIC FT.	LIST PRICE	HP ADD
A2036MDRS	19.25 x 36 x 28	100	137	15	\$1490	N/A
A2436MDRS	23.25 x 36 x 28	100	150	18	\$1515	N/A

For use **under 29"H limited single pedestal desks, workstations or limited single pedestal credenzas. Unfinished top, no back.** Two box drawers on **left**, one file drawer on **right** and one lateral file drawer on bottom. File and lateral file drawers locking. 1 pencil tray. Front-to-back filing bars.

- Black handles are standard. Silver is available at no charge, please specify as **SI**.
- File drawer construction is for accommodating hanging files **NOT** for stacking materials on the drawer bottom.
- For 24" deep worksurfaces, order **A2436MDRS**. For 20" deep worksurfaces, order **A2036MDRS**.

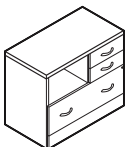

Mixed Storage Cabinet

A2436MSC	24 x 36 x 29	100	163	18.25	\$1142	\$124
A2036MSC	20 x 36 x 29	100	147	15.50	\$1056	\$124

Features open storage compartment with access grommet on back. 2 box drawers and 1 lateral file drawer, all locking. 1 pencil tray. Front-to-back filing bars.

- To comply with ANSI/BIFMA stability tests, the Lateral File Counter Weight Kit (model LFCWKIT36 - pg. 40) MUST be used.
- Black handles are standard. Silver is available at no charge, please specify as **SI**.
- File drawer construction is for accommodating hanging files **NOT** for stacking materials on the drawer bottom.



Mixed Storage Cabinet Shell

A2436MSCS	23.25 x 36 x 28	100	121	14.90	\$1113	N/A
A2036MSCS	19.25 x 36 x 28	125	136	17.45	\$1026	N/A

For use **under 29"H limited single pedestal desks, workstations or limited single pedestal credenzas. Unfinished top, no back.** Features open storage compartment with access grommet on back. 2 box drawers and 1 lateral file drawer, all locking. 1 pencil tray. Front-to-back filing bars.

- Black handles are standard. Silver is available at no charge, please specify as **SI**.
- File drawer construction is for accommodating hanging files **NOT** for stacking materials on the drawer bottom.
- For 24" deep worksurfaces, order **A2436MSCS**. For 20" deep worksurfaces, order **A2036MSCS**.



2 Drawer Lateral File

A2036LF	20 x 36 x 29	100	145	15.50	\$944	\$124
---------	--------------	-----	-----	-------	--------------	--------------

Two full suspension drawers. Front-to-back and side-to-side letter/legal filing capability with lock. Anti-lock tilt suspension.

- To comply with ANSI/BIFMA stability tests, the Lateral File Counter Weight Kit (model LFCWKIT36 - pg. 40) MUST be used.
- Black handles are standard. Silver is available at no charge, please specify as **SI**.
- File drawer construction is for accommodating hanging files **NOT** for stacking materials on the drawer bottom.

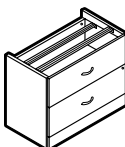

2 Drawer Lateral File Shell

A2436S2	24 x 36 x 28.5	125	114	18	\$1143	N/A
A2036S2	20 x 36 x 28.5	125	104	14.75	\$1143	N/A

For use **under 29"H limited single pedestal desks, workstations or limited single pedestal credenzas. No top or back.** Two full suspension locking drawers with **steel drawer interior**. Side-to-side file bars included. Anti-lock tilt suspension.

- Black handles are standard. Silver is available at no charge, please specify as **SI**.
- For 24" deep worksurfaces, order **A2436S2**. For 20" deep worksurfaces, order **A2036S2**.
- For front-to-back file bars order **FBB**; See "FBB" on page 699.

Required Specifications

Top finish (not shells)
Base finish
Handles
Edge detail*

Optional Specifications

Key #
HP laminate (not shells)

ACCESSORY PIECES

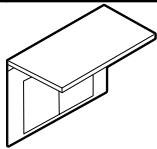
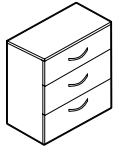
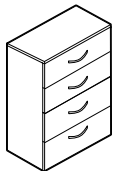
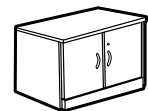
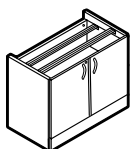
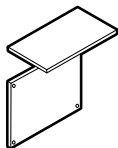
**2 Drawer Lateral File Top and Back****3 Drawer Lateral File****4 Drawer Lateral File****Storage Cabinet****Storage Cabinet Shell****Storage Cabinet Top and Back**

MODEL#	DIMENSIONS	FREIGHT CLASS	WT/LBS.	CUBIC FT.	LIST PRICE	HP ADD
--------	------------	---------------	---------	-----------	------------	--------

D x W x H

ALF24TB	24 x 36 x 29	65	82	3.30	\$390	\$156
ALF20TB	20 x 36 x 29	65	78	3.30	\$390	\$156

For use with Lateral File Shell. Counterweights included. Shipped RTA (ready to assemble).

- Use **ALF24TB** for model A2436S2. Use **ALF20TB** for model A2036S2.

A2036S3	20 x 36 x 37.75	92.5	219	20	\$1643	\$124
---------	-----------------	------	-----	----	---------------	--------------

Three full suspension locking drawers with **steel drawer interior**. Side-to-side file bars included. Anti-lock tilt suspension.

- Black handles are standard. Silver is available at no charge, please specify as **SI**.
- For front-to-back file bars order **FBB**; See "FBB" on page 699.

A2036S4	20 x 36 x 49.5	92.5	267	25.75	\$2068	\$124
---------	----------------	------	-----	-------	---------------	--------------

Four full suspension locking drawers with **steel drawer interior**. Side-to-side file bars included. Anti-lock tilt suspension.

- Black handles are standard. Silver is available at no charge, please specify as **SI**.
- For front-to-back file bars order **FBB**; See "FBB" on page 699.

A2036SC	20 x 36 x 29	125	121	15.50	\$723	\$124
---------	--------------	-----	-----	-------	--------------	--------------

Self-closing hinged doors cover one adjustable shelf. Standard with lock.

- Black handles are standard. Silver is available at no charge, please specify as **SI**.

A2436SCS	23.25 x 36 x 28.5	150	106	18	\$624	N/A
A2036SCS	19.25 x 36 x 28.5	125	91	14.75	\$624	N/A

For use **under 29" H limited single pedestal desks, workstations or limited single pedestal credenzas. No top or back**. Self-closing hinged doors cover one adjustable shelf. Standard with lock.

- Black handles are standard. Silver is available at no charge, please specify as **SI**.
- For 24" deep worksurfaces, order **A2436SCS**. For 20" deep worksurfaces, order **A2036SCS**.

ASC24TB	24 x 36 x 29	85	49	3.30	\$264	\$156
ASC20TB	20 x 36 x 29	85	45	3.30	\$264	\$156

For use with **Storage Cabinet Shell**. Shipped RTA (ready to assemble).

- Use **ASC24TB** for model A2436SCS/MSCS; use **ASC20TB** for model A2036SCS/MSCS.

Required Specifications

Top finish (not shells)
Base finish
Handles
Edge (not A2xxxSCS)

Optional Specifications

Key #
HP laminate

ACCESSORY PIECES

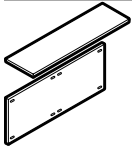

Credenza Top and Back

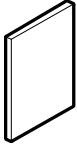

Full Leg



Personal Tower



Personal Tower

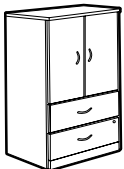

Vertical Storage/Lateral File Cabinet

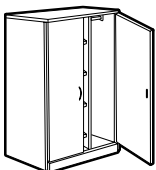

Storage Wardrobe Cabinet

MODEL#	DIMENSIONS D x W x H	FREIGHT CLASS	WT/LBS.	CUBIC FT.	LIST PRICE	HP ADD
A2472TB	24 x 72 x 29	70	95	6	\$540	\$269
A2072TB	20 x 72 x 29	85	87	6	\$540	\$258

For use with the following: **two Lateral File Shells**, or **two Storage Cabinet Shells**, or **two Mixed Storage Cabinet Shells**, or any combination. May also be used with **one Lateral File Shell plus one Full Leg**, or **one Storage Cabinet/Mixed Storage Cabinet Shell plus one Full Leg**. Shipped RTA (ready to assemble).

- For 24" deep worksurfaces, order **A2472TB**. For 20" deep worksurfaces, order **A2072TB**.

A24FL	24 x 1 x 28	92.5	20	1.70	\$189	N/A
A20FL	20 x 1 x 28	65	16	.60	\$189	N/A

For use at **either end of A24/2072TB Credenza Top and Back** to create a kneespace. Non-handed; can be used left or right. Shipped RTA (ready to assemble).

- For 24" deep worksurfaces, order **A24FL**. For 20" deep worksurfaces, order **A20FL**.

A24PTFF	24 x 24 x 65	100	219	27	\$1883	N/A
A20PTFF	20 x 24 x 65	100	198	22.75	\$1883	N/A

Includes 7" wardrobe section with a hanging rod; storage section with one adjustable shelf; and file section with **two file drawers**. Locks are keyed alike. Upper lock secures wardrobe and storage section. Lower lock secures both file drawers.

- Black handles are standard. Silver is available at no charge, please specify as **SI**.

A24PTBBF	24 x 24 x 65	125	213	27	\$1883	N/A
A20PTBBF	20 x 24 x 65	100	193	22.75	\$1883	N/A

Includes 7" wardrobe section with a hanging rod; storage section with one adjustable shelf; and file section with **box-box-file drawers**. Locks are keyed alike. Upper lock secures wardrobe and storage section. Lower lock secures all drawers.

- Black handles are standard. Silver is available at no charge, please specify as **SI**.

A3665VSL	20 x 36 x 65	100	273	33	\$1761	N/A
----------	--------------	-----	-----	----	---------------	-----

Contains storage area with one adjustable shelf behind a self-closing hinged door, plus two full suspension file drawers. Lateral file drawers lock.

- File drawer construction is for accommodating hanging files NOT for stacking materials on the drawer bottom.
- Black handles are standard. Silver is available at no charge, please specify as **SI**.

A2436DI	24 x 36 x 65	70	254	11.50	\$2177	N/A
A3665DI	20 x 36 x 65	70	237	11.50	\$1922	N/A

Includes 16" hanging rod on one side and four adjustable shelves on the other. Lock. Shipped RTA (ready to assemble).

- Black handles are standard. Silver is available at no charge, please specify as **SI**.

Required Specifications

Top finish
Base finish
Handles (only personal towers)
Edge detail*

Optional Specifications

Key # (not credenzas or full leg)
HP laminate (tops and backs)

ACCESSORY PIECES

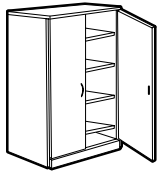

Storage Cabinet

MODEL#	DIMENSIONS D x W x H	FREIGHT CLASS	WT/LBS.	CUBIC FT.	LIST PRICE	HP ADD
A2436SH	24 x 36 x 65	65	280	11.50	\$1917	N/A
A3665SH	20 x 36 x 65	65	261	11.50	\$1680	N/A

Includes four adjustable shelves. Lock. Shipped RTA (ready to assemble).

- Black handles are standard. Silver is available at no charge, please specify as **SI**.

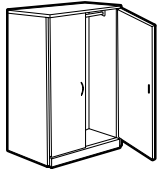

Wardrobe Cabinet

A2436ROD	24 x 36 x 65	70	205	11.50	\$2075	N/A
A3665ROD	20 x 36 x 65	70	198	11.50	\$1761	N/A

Includes full width hanging rod. Lock. Shipped RTA (ready to assemble).

- Black handles are standard. Silver is available at no charge, please specify as **SI**.

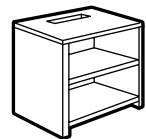

Printer Table

A2430PT	24 x 30 x 29	65	108	4.30	\$723	\$124
---------	--------------	----	-----	------	--------------	--------------

Includes two fixed shelves, cut-back top shelf allows paper to fall onto lower shelf. Shipped RTA (ready to assemble).

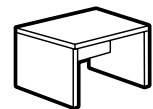

Magazine Table

A2248MT	22 x 48 x 18	85	61	4.30	\$403	\$176
A2222MT	22 x 22 x 18	85	40	3	\$324	\$93

Shipped RTA (ready to assemble).

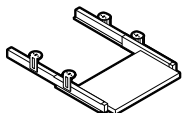

Pull-Out Keyboard

APOKL28	17 x 28 x 3.5	85	13	.90	\$245	N/A
APOKL22	17 x 22 x 3.5	85	12	.90	\$221	N/A

Constructed of thermofused laminate. **APOKL28** will accommodate keyboard and mousepad. **APOKL28** will only fit on a single pedestal desk, freestanding table, or **A42205C**. Please specify color from available finishes listed on pg. 11.

- **APOKL28** will not fit extended corners or **A42245C**, **A36205C** 5-sided corners.

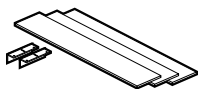

Counter Weight Kit

LFCWKIT36	6 x 33 x 1	60	40	.25	\$533	N/A
-----------	------------	----	----	-----	--------------	-----

3 metal plates. Plates mount to the underside of any 36" wide Lateral File or Mixed Storage/Drawer cabinet. Includes mounting hardware. Must be ordered separately. Field installed.

- To comply with ANSI/BIFMA stability tests, the Lateral File Counter Weight Kit MUST be used with the appropriate Lateral Files and Mixed Storage Cabinets.

Required Specifications

Top finish
Base finish
Handles
Edge detail

Optional Specifications

Key #
HP laminate (only printer / magazine table)

A ADAPTABILITIES®

BOOKCASES

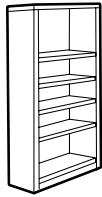

Bookcase - 72" High*

MODEL#	DIMENSIONS D x W x H	FREIGHT CLASS	WT/LBS.	CUBIC FT.	LIST PRICE	HP ADD
ABC72	12 x 36 x 72	125	170	23	\$865	N/A

One fixed heavy duty shelf and **three adjustable shelves**. Shipped fully assembled.

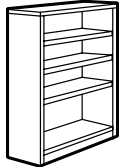

Bookcase - 65" High*

ABC65	12 x 36 x 65	125	150	21	\$844	N/A
-------	--------------	-----	-----	----	--------------	-----

One fixed heavy duty shelf and **two adjustable shelves**. Shipped fully assembled.

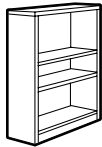

Bookcase - 48" High*

ABC48	12 x 36 x 48	125	116	15.75	\$643	N/A
-------	--------------	-----	-----	-------	--------------	-----

Two adjustable shelves. Shipped fully assembled.

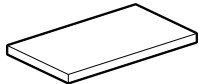

Bookcase Shelf

ABCSELF	12 x 34 x 1	100	13	1.50	\$161	N/A
---------	-------------	-----	----	------	--------------	-----

Extra shelf for bookcases. 1" thick.

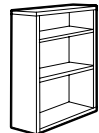
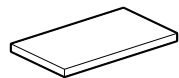

Table Top Bookcase

A3636TBC	15 x 36 x 36	125	111	17	\$552	N/A
ADOOR3636	.69 x 36 x 36	125	35	4.50	\$278	N/A

To be placed on top of 36" w lateral file or storage cabinet. Two adjustable shelves.

- For a set of doors, order **ADOOR3636**
- Locks available on ADOOR3636. ADD \$95.00 each lock.



Bookcase Shelf

ATBC36SH	13.25 x 34 x 1	100	16	1.70	\$153	N/A
----------	----------------	-----	----	------	--------------	-----

Extra shelf for TABLE TOP bookcases. 1" thick.

Required Specifications

- Top finish*
- Base finish*
- Edge detail*

END SHELVES

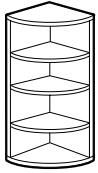

End Shelf - 65" High

MODEL#	DIMENSIONS D x W x H	FREIGHT CLASS	WT/LBS.	CUBIC FT.	LIST PRICE	HP ADD
A2465ESHL	24 x 24 x 65	65	136	5	\$908	N/A
A2065ESHL	20 x 20 x 65	65	113	5	\$764	N/A
A2465ESHR	24 x 24 x 65	65	136	5	\$908	N/A
A2065ESHR	20 x 20 x 65	65	113	5	\$764	N/A

For use at end of **wardrobe/storage, vertical storage cabinets, and personal towers**. Four fixed shelves. Shipped RTA (ready to assemble). **Specify left or right.**

- For 24" deep cabinet, order **A2465ESH**. For 20" deep cabinet, order **A2065ESH**.

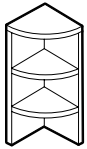

End Shelf - 36" High

A1536ESHL	15 x 15 x 36	85	44	3.30	\$367	N/A
A1536ESHR	15 x 15 x 36	85	44	3.30	\$367	N/A

For use at end of **hutches**. Two fixed shelves. To be used on top of **A3029ESHL/R, A2429ESHL/R or A2029ESHL/R**. Shipped RTA (ready to assemble). **Specify left or right.**

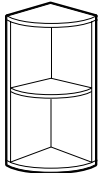

End Shelf - 29" High

A3029ESHL	30 x 30 x 29	70	104	5.25	\$643	\$207
A2429ESHL	24 x 24 x 29	70	77	4.30	\$524	\$104
A2029ESHL	20 x 20 x 29	70	60	3.80	\$446	\$83
A3029ESHR	30 x 30 x 29	70	104	5.25	\$643	\$207
A2429ESHR	24 x 24 x 29	70	77	4.30	\$524	\$104
A2029ESHR	20 x 20 x 29	70	60	3.80	\$446	\$83

For use at end of **worksurfaces**. Two fixed shelves. Shipped RTA (ready to assemble). **Specify left or right.**

- For 30" deep worksurface, order **A3029ESH**. For 24" deep worksurface, order **A2429ESH**.
For 20" deep worksurface, order **A2029ESH**.

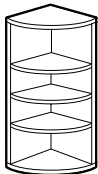

End Shelf - 49 1/2" High

A2049ESHL	20 x 20 x 49.5	65	94	3.80	\$672	N/A
A2049ESHR	20 x 20 x 49.5	65	94	3.80	\$672	N/A

For use at end of **A2036S4 4-high lateral file**. Four fixed shelves. Shipped RTA (ready to assemble). **Specify left or right.**

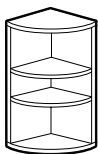

End Shelf - 37 3/4" High

A2037ESHL	20 x 20 x 37.75	70	77	5	\$489	N/A
A2037ESHR	20 x 20 x 37.75	70	77	5	\$489	N/A

For use at end of **A2036S3 3-high lateral file**. Three fixed shelves. Shipped RTA (ready to assemble). **Specify left or right.**

Required Specifications

Top finish
Base finish
Edge detail

Optional Specifications

HP Laminate (End Shelf, 29"h)

PEDESTALS



Freestanding Pedestal

MODEL#	DIMENSIONS D x W x H	FREIGHT CLASS	WT/LBS.	CUBIC FT.	LIST PRICE	HP ADD
AFPBBF19	19 x 16 x 28	100	68	7.25	\$787	N/A
AFPBBF22	22 x 16 x 28	100	72	8.25	\$806	N/A
AFPBBF28	28 x 16 x 28	100	88	10.25	\$838	N/A

For use under a freestanding worksurface (20", 24" or 30"); attaches to worksurface top. No top and unfinished back. Two box and one file drawer. One pencil tray. File drawer and lower box drawer are locking.

- Cannot be used with **A2466** extended corners.
- When used with Connectable Tables (e.g. A2472T) bottom rear of pedestal will show because of the modesty on table units



Freestanding Pedestal

AFPFF19	19 x 16 x 28	100	67	7.25	\$852	N/A
AFPFF22	22 x 16 x 28	100	75	8.25	\$864	N/A
AFPFF28	28 x 16 x 28	100	89	10.25	\$911	N/A

For use under a freestanding worksurface (20", 24" or 30"); attaches to worksurface top. No top and unfinished back. Two file drawers. Locking.

- Cannot be used with **A2466** extended corners.
- When used with Connectable Tables (e.g. A2472T) bottom rear of pedestal will show because of the modesty on table units

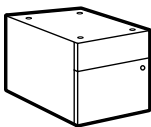

Hanging Pedestal

AHPBF18	18 x 16 x 18	92.5	48	4.50	\$549	N/A
---------	--------------	------	----	------	--------------	-----

For use under a freestanding worksurface (20", 24" or 30"); attaches to worksurface top. No top and unfinished back. One box and one file drawer. One pencil tray. Locking. 18" high.

- Cannot be used with **A2466** extended corners.
- When used with Connectable Tables (e.g. A2472T) bottom rear of pedestal will show because of the modesty on table units



Mobile Pedestal*

AMPBBF19	19 x 16 x 28	85	96	6.50	\$822	\$156
AMPBBF22	23 x 16 x 28	92.5	92	7.75	\$831	\$154
AMPBBF28	29 x 16 x 28	92.5	105	9.50	\$864	\$156

Pedestal on casters. Front casters lock. Fits under worksurfaces and is easily moved. Two box and one file drawer. One pencil tray. File drawer and lower box drawer are locking.

- Cannot be used with **A2466** extended corners.

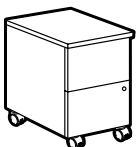

Mobile Pedestal*

AMPFF19	19 x 16 x 28	85	97	6.50	\$885	\$156
AMPFF22	23 x 16 x 28	85	95	7.75	\$898	\$156
AMPFF28	29 x 16 x 28	92.5	106	9.50	\$944	\$156

Pedestal on casters. Front casters lock. Fits under worksurfaces and is easily moved. Two file drawers. Locking.

- Cannot be used with **A2466** extended corners.

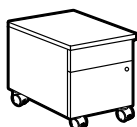

Mobile Pedestal*

AMPBF19	19 x 16 x 22	85	77	5.25	\$723	\$156
AMPBF22	23 x 16 x 22	85	73	6	\$740	\$156
AMPBF28	29 x 16 x 22	92.5	83	7.50	\$760	\$156

Pedestal on casters. Front casters lock. Fits under worksurfaces and is easily moved. One box and one file drawer. One pencil tray. Locking. 22" high.

Required Specifications

Top finish
Base finish*

Optional Specifications

Key #
HP laminate (mobile pedestal)
Handle

BOARDROOM TABLES



Boardroom Table - Round Top*

MODEL#	DIMENSIONS D x W x H	FREIGHT CLASS	WT/LBS.	CUBIC FT.	LIST PRICE	HP ADD
A48R	48 x 48 x 1.5	85	95	7.50	\$467	\$362
A42R	42 x 42 x 1.5	85	73	5.75	\$446	\$362
A36R	36 x 36 x 1.5	92.5	54	4.90	\$324	\$207

A48R may be used with four monoposts. **A36R** and **A42R** may be used only with cross base or drum base.

- Available with the **Bicut Edge** at no upcharge. Please Specify "**CR**".
- **A48R** to be used with four monopost legs only, model **A5L**.
- **A42R** to be used with four monoposts (**A5L**) or cross base **A2727XB**
- **A36R** to be used with four monoposts (**A5L**) or drum base **A18Z**



Boardroom Table - Rectangular Top*

A48120RE	48 x 120 x 1.5	70	274	13	\$1003	\$826
A4896RE	48 x 96 x 1.5	65	314	11.50	\$764	\$671
A3672RE	36 x 72 x 1.5	65	175	7	\$563	\$387

For use with two drum bases, two "V" bases, one panel base OR four monoposts. Predrilled for "V" base and panel base.

Top comes in one piece, except for A48120RE (two pieces)

- Available with the **Bicut Edge** at no upcharge. Please Specify "**CR**".
- **A48120RE** uses three drum bases, three "V" bases, one double panel base OR six monoposts.



Boardroom Table - Boat Shape Top

A48144B	48 x 144 x 1.5	60	237	7.50	\$1163	\$980
A48120B	48 x 120 x 1.5	60	198	6.30	\$1003	\$826
A4896B	48 x 96 x 1.5	70	193	9.80	\$787	\$671

For use with three drum bases, three "V" bases, one double panel base OR six monoposts. Predrilled for "V" base and panel base. **Top comes in two pieces, except for A4896B.**

- Available with the **Bicut Edge** at no upcharge. Please Specify "**CR**".
- **A4896B** uses two drum bases, two "V" bases, one panel base OR four monoposts.



Boardroom Table - Racetrack Top

A48144RT	48 x 144 x 1.5	60	251	7.50	\$1163	\$980
A48120RT	48 x 120 x 1.5	60	204	6.30	\$1003	\$826
A4896RT	48 x 96 x 1.5	70	200	9.80	\$787	\$671
A3672RT	36 x 72 x 1.5	70	112	5.80	\$605	\$387

For use with three drum bases, three "V" bases, one double panel base OR six monoposts. Predrilled for "V" base and panel base. **Top comes in two pieces except for A4896RT and A3672RT.**

- Available with the **Bicut Edge** at no upcharge. Please Specify "**CR**".
- **NOTE:** 48" x 120" and 48" x 144" woodgrain finish Adaptabilities tables will not have a perfect match of grain at the center where the two halves meet.
- **A4896RT** and **A3672RT** use two drum bases, two "V" bases, one panel base OR four monoposts.

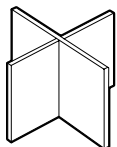

Cross Base

A2727XB	27 x 27 x 28	70	63	3.60	\$300	N/A
---------	--------------	----	----	------	--------------	-----

Use as the base for **36" or 42" round tops (model A36R or A42R)**. Shipped RTA (ready to assemble).

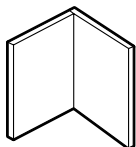

"V" Base

A1616V	16 x 16 x 28	60	39	1.10	\$255	N/A
A1616V2	16 x 16 x 28	60	74	1.10	\$504	N/A

Use as the base for **rectangular, boat shaped or racetrack tops**. Shipped RTA (ready to assemble).

- **A1616V2** is shipped 2 bases per carton.

Required Specifications

Finish
Edge detail*

Optional Specifications

HP laminate*

A ADAPTABILITIES®

BOARDROOM TABLES

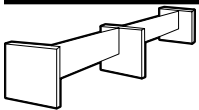

Panel Base

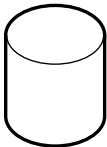

Drum Base

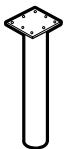

Mono Post

MODEL#	DIMENSIONS	FREIGHT CLASS	WT./LBS.	CUBIC FT.	LIST PRICE	HP ADD
--------	------------	---------------	----------	-----------	------------	--------

D x W x H

A2488PB	24 x 88 x 28	70	119	6	\$803	N/A
A2445PB	24 x 45 x 28	70	76	4.30	\$524	N/A

Use as the base for **rectangular, boat shaped or racetrack tops**. Shipped RTA (ready to assemble).

- Use **A2488PB** for 120 - 144" wide tops.
- Use **A2445PB** for 72 - 96" wide tops.

A18Z	18 x 18 x 28	250	29	7.50	\$563	N/A
------	--------------	-----	----	------	--------------	-----

Use as the base for **36" or 42" round tops (model A36R or A42R)** and **72", 96", 120" or 144" wide tops**. Available in **Black finish only**.

- All Drum Bases require approx. 125 lb. of sand in each base for adequate stability. Sand not included.

A5L	5 x 5 x 28	100	13	1.50	\$245	N/A
-----	------------	-----	----	------	--------------	-----

Use as the base for **48" (model A48R) round tops** and **72", 96", 120" or 144" wide tops**.

- Post is shipped in separate carton. Standard in Black; Silver is available at no charge, please specify **SI**.

BOARDROOM ACCESSORIES



Serving Cart*

A2036SK	20 x 36 x 36	100	179	19	\$1680	\$124
---------	--------------	-----	-----	----	---------------	--------------

Includes **two** side opening, self-closing hinged doors, **two box drawers**, one slide-out tray and storage shelf. On casters.

- Available with the **Bicut Edge** at no upcharge. Please Specify "**AR**".
- Black handles are standard. Silver is available at no charge, please specify as **SI**.



Serving Cart*

A2020SK	20 x 20 x 36	92.5	114	11	\$1054	\$83
---------	--------------	------	-----	----	---------------	-------------

Includes **one** side opening, self-closing hinged door, **one box drawer**, one slide-out tray and storage shelf. On casters.

- Available with the **Bicut Edge** at no upcharge. Please Specify "**CR**".
- Black handles are standard. Silver is available at no charge, please specify as **SI**.

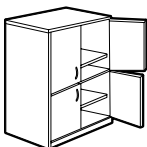

Audio/Visual Cabinet*

A2436AV	24 x 36 x 65	65	272	11.25	\$1922	N/A
---------	--------------	----	-----	-------	---------------	-----

Includes **four** side opening doors covering two adjustable and two fixed shelves. Wire access through one grommet on back panel. Holds up to 27"H TV monitor. Shipped RTA (ready to assemble).

- Black handles are standard. Silver is available at no charge, please specify as **SI**.

Required Specifications

Top finish *
Base finish
Handles*
Edge detail*

Optional Specifications

Key #*
HP laminate*

BOARDROOM ACCESSORIES

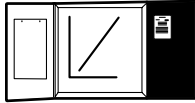

Visual Board*

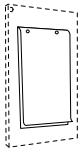

Flip Chart Pad

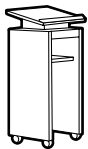

Lectern*

MODEL#	DIMENSIONS	FREIGHT CLASS	WT/LBS.	CUBIC FT.	LIST PRICE	HP ADD
--------	------------	---------------	---------	-----------	------------	--------

D x W x H

AVB4848	4 x 48 x 48	70	135	9	\$1203	N/A
---------	-------------	----	-----	---	---------------	-----

Includes white board and two side opening doors containing cork board on right door and 50-sheet paper writing pad on left door. Marker board can be used for projection. Set of 4 dry markers and eraser included.

- **NOTE:** Care should be taken to mount the units. Units should be mounted to wall studs using correct fasteners. Failure to do so may result in collapse of the unit and subsequent personal injury. Mounting hardware not included. Mounting hardware used should be based on wall material. Consult an installation professional for proper wall mounting.

FC	30 x 20 x 30	92.5	20	2	\$277	N/A
----	--------------	------	----	---	--------------	-----

Additional flip chart paper for double door visual boards. 50 sheets per pad. Five pads per package. Price is per package.

A1844LC	18 x 24 x 44	70	92	4.80	\$643	\$83
---------	--------------	----	----	------	--------------	-------------

Features angled stand, storage shelf and casters. Shipped RTA (ready to assemble).

Required Specifications

Top finish*
Base finish*

Optional Specifications

HP laminate (Lectern)



Correlation is designed with solid 1.5" thick tops and 72" high cabinets and hutches that accommodate larger computer monitors. Correlation excels in executive and management applications and coordinates with Adaptabilities for the open office. Select the perfect package for your office from over 370 components in 400 exciting color combinations, from traditional to contemporary. The enhanced size of the bow front executive desk model complements your professional setting with extra legroom and workspace for visitors.

Set the tone for executive conferences with Correlation's sophisticated boardroom tables. A solid choice for professional workspaces, Correlation features 1.5" thick worksurfaces made from high-performance, thermally fused laminate. Tops and bases can be mixed and matched to accommodate any design requirement.

Let Global and Correlation bring some real team work to the general office area. Correlation's curvilinear worksurfaces and storage components support the flow of people in your office and help you work more comfortably and productively. Choose from a broad selection of storage options, including a unique mixed storage center and personal towers.



Features and Benefits

- 45lb. density particle board substructure with high performance thermally fused laminate
- 1½" thick worksurfaces in thermally fused or high pressure laminate
- Worksurfaces feature Global's preferred edging in matching color
- Full to floor or ¾ pedestals available on most components
- All desks are size (incrementally) accurate
- 11/16" thick full modesty panel is standard
- 11/16" thick ¾ modesty panel is available on most components
- 75lb. box - 150 lb. file drawer weight capacity with full height sides, plus pencil tray included in box drawer
- File drawers can accommodate legal or letter documents
- Full progressive ball bearing suspension on file drawers
- All drawer fronts edge banded with side pull opening pedestals and standard with pedestal locks
- Compatible with **Divide** panel system for increased privacy and storage requirements



Tops are 1½" thick - optional fluted edge



¾ modesty panel available at no extra charge



For heavy duty usage, two, three and four drawer laminate files available with six handle options

GENERAL INFORMATION

- Constructed of 45 lb. density particleboard with high performance thermally fused laminate
- Correlation components are compatible with Divide, eO+ and GPS II transaction tops and partitioning panels
- Overall 72" height fits larger computer monitors comfortably under hutches
- Optional fluted edge available at no extra charge
- Six handle options available for components with handles
- Correlation desk and storage products have been tested and comply with all BIFMA mechanical tests.
- GREENGUARD INDOOR AIR QUALITY CERTIFICATION - Global laminate and seating products are in compliance with stringent emission guidelines set out by the Greenguard Environmental Institute under the standards for low emitting products and materials. www.greenguard.org.
- **Level 3 Certified**

WORKSURFACES

- 1.5" thick high performance thermally fused laminate tops
- All finishes feature Global's preferred edging in matching color (i.e. woodgrain surfaces feature edging with matching printed woodgrain) or an optional **fluted edge**, specify **(FL)**. **Must specify code 3M or FL after the model number when placing an order.**
- High Pressure Tops are available in all Correlation laminate finishes at an extended lead time. Please see model # for pricing and availability

CONSTRUCTION

- Constructed of 45 lb. density particleboard with high performance thermally fused laminate.
- Hutches are 42½" high and are offered with closed back only. Straight hutches are shipped assembled. Corner hutches are shipped KD.
- Cabinets and Wardrobes are 72" high to match overall height of a worksurface with hutch (worksurface 29½" + hutch 42½" = 72").
- End Shelves are available as 72" high also to match overall height.
- Models with monoposts are standard with a Black monopost; Silver is available at no charge, please specify as **SI**. The Silver finish will match the Silver finish used on Divide.
- Double wall pedestal housing with fully closed bottom

MODESTY PANELS

- 11/16" thick full modesty panel is standard and raised 1" off the ground.
- 11/16" thick ¾ modesty panel available on most components
- ¾ height modesty panels available on most models at no additional charge. Please specify "3MP". (Corners must have both modesty panels as ¾ or full). These panels are 10" from the ground.
- **Note:** Woodgrain modesty panels over 60" wide will have the grain pattern in the horizontal direction. All end panels and modesty panels 60" or less will have the grain pattern in the vertical direction.

LOCKS

- Optional locks available for all straight hutch unit doors. Add **\$95.00** for each lock.
- Front-to-back filing bars for all steel drawer files available separately. Order FBB file bars. See "FBB" on page 699.

SPECIAL SIZES

- Additional custom sized components available upon request.
- Secretarial height returns (26 ½") available at a 15% upcharge.
- Full to the floor pedestal configurations can be switched for a 15% upcharge.
- Correlation boardroom table tops are now available with the Bicut Edge **(CR)** at no upcharge. Please specify.

STORAGE

- All Lateral File drawer fronts feature the woodgrain running in a horizontal direction.
- 75 lb box - 150 lb. file drawer weight capacity with full height sides with pencil tray included in box drawer
- File drawers can accommodate legal or letter documents
- Full progressive ball bearing suspension on file drawers
- All mobile pedestals have a metal plate counterweight

HANDLES

- Handles are standard on Lateral Files and Storage Cabinets. All other Correlation drawers, including mobile, freestanding and hanging pedestals, can be ordered with a choice of six handle options to be factory installed. Each handle is identified by the letters "**HU**", "**HV**", "**HW**", "**HX**", "**HS**", or "**HZ**". Please note that the small 96 mm style pull will be installed when specifying **HU** or **HV**. To specify a handle, please specify the code after the model number. To order a handle as an option, please specify the code when ordering, List Price is **\$35**.

**HW** Flared Satin Brass Handle**HX** Flared Black Matte Handle**HZ** Dimpled Nickel Matte Handle**HS** Bow Handle, Silver Finish**HV** Silver Handle**HU** Matte Black Handle

1. SPECIFY MODEL NUMBER

2. SPECIFY FINISH

One Tone Finishes:

ACJ	Absolute Acajou
ASN	Asian Night
AWC	Avant Cherry
AWH	Avant Honey
BLK	Black
BRC	Brushed Cobalt
CSJ	Constellation Java
DES	Dark Espresso
HGT	Hayden Grey
QTM	Quartered Mahogany
SKC	Shaker Cherry
SOG	Storm Grey
TFW	Tiger Fruitwood
TMA	Tiger Mahogany
TMP	Tiger Maple
TWL	Tiger Walnut
WHT	White
WHC	White Chocolate*
WGY	Willow Grey
WCR	Winter Cherry

Top Finishes:

ACJ	Absolute Acajou
ASN	Asian Night
AWC	Avant Cherry
AWH	Avant Honey
BLK	Black
BRC	Brushed Cobalt
CSJ	Constellation Java
DES	Dark Espresso
HGT	Hayden Grey
QTM	Quartered Mahogany
SKC	Shaker Cherry
SOG	Storm Grey
TFW	Tiger Fruitwood
TMA	Tiger Mahogany
TMP	Tiger Maple
TWL	Tiger Walnut
WHT	White
WHC	White Chocolate*
WGY	Willow Grey
WCR	Winter Cherry

Body Finishes (including pedestals):

ACJ	Absolute Acajou
ASN	Asian Night
AWC	Avant Cherry
AWH	Avant Honey
BLK	Black
BRC	Brushed Cobalt
CSJ	Constellation Java
DES	Dark Espresso
HGT	Hayden Grey
QTM	Quartered Mahogany
SKC	Shaker Cherry
SOG	Storm Grey
TFW	Tiger Fruitwood
TMA	Tiger Mahogany
TMP	Tiger Maple
TWL	Tiger Walnut
WHT	White
WHC	White Chocolate*
WGY	Willow Grey
WCR	Winter Cherry

*textured, HP non textured, top only

3. SPECIFY OPTIONS

Grommets

- Additional grommets available in standard worksurface locations (left, center or right).

- Order as: **AG1, AG2 or AG3.....Add \$65**



- Grommet hole dimensions are 3 1/4" wide x 1 7/8" deep.
- Actual grommet locations on the worksurface are depicted in the example drawings shown below. Dimensions shown are actual measurements (in inches).

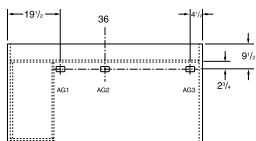

36 x 72 single pedestal left desks (3672SPL)

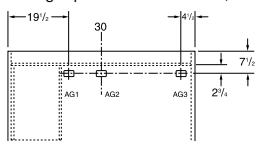

30 x 60 single pedestal left desks (3060SPL)

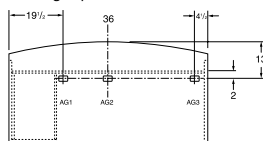

36 x 72 single pedestal left bow top desks (3672SLB)

with vertical and horizontal dimensions to the center of the cut-out (as in drawing above). Please refer to CUSTOM GROMMET LOCATION FORM in the back reference section.

- Components that come standard with grommet may be ordered without a grommet. **Add \$35.**
- Grommets are available on modesty panels of extended corners and 5-sided corners 6 1/2" in where the two modesty panels meet at a 90° angle. Please specify FOGMPR for right grommet placement and FOGMPL for left grommet (placement is as shown on diagrams below). Cost is **\$65.**

****Modesty Panels are 1" off of ground**

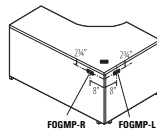

Left Extended Corner Unit

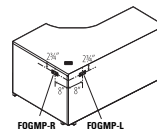

Right Extended Corner Unit

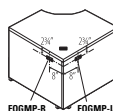

5-Sided Corner Unit

Power Block

- Grommets may be placed at non-standard locations. Order as: **AGS - Add \$65.** A drawing must be supplied
- A Power Block (model PMSPPDM) may be ordered on all worksurfaces.

- A Power Block is a rectangular worksurface power/data module with one electrical duplex receptacle and two data (RJ45) receptacles. 9 foot black cord included. Power Block dimensions are 3 1/2" deep x 6 1/2" wide x 2 3/4" high.
- To purchase a Power Block, you must specify both the Power Block cut-out location and the Power Block model #. Order Power Block as **PMSPPDM, Add \$238.** Power Blocks are available in standard worksurface locations (left, center or right). Order as E1, E2 or E3. **Add \$65.**



Power Block **PMSPPDM Add \$238**

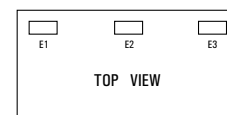

Specify location **E1, E2 or E3 Add \$65**

Handles (see previous page)

- Standard on lateral files and storage cabinets
- To order as an option on all other Correlation drawers, **Add \$35.**

DOUBLE PEDESTAL DESKS

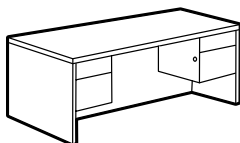

Double Pedestal Desk

MODEL#	DIMENSIONS D x W x H	FREIGHT CLASS	WT./LBS.	CUBIC FT.	LIST PRICE	HP ADD
C3672DP	36 x 72 x 29.5	125	334	52.50	\$1532	\$439
C3072DP	29.69 x 72 x 29.5	125	296	43	\$1464	\$362
C3066DP	29.69 x 66 x 29.5	125	284	39.75	\$1458	\$362
C3060DP	29.69 x 60 x 29.5	125	274	36.25	\$1383	\$336

Standard with box/file pedestals on both sides. Pedestals lock. One pencil tray.

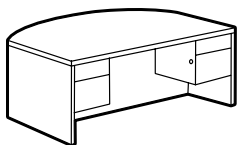

Double Pedestal Bow Top Desk

C4284DPB	38-42 x 84 x 29.5	150	397	70	\$2280	\$567
C3672DPB	32-36 x 72 x 29.5	150	312	52.50	\$1793	\$439

Standard with box/file pedestals on both sides and bow top. Pedestals lock. One pencil tray.

- Due to the large size of **C4284DPB**, please consider the clearance of doorways and corridors

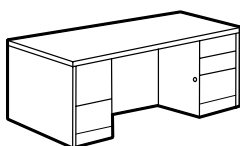

Full to Floor Double Pedestal Desk

C3672D4	36 x 72 x 29.5	125	363	52.50	\$1905	\$439
C3072D4	30 x 72 x 29.5	125	323	43.75	\$1851	\$439
C3066D4	29.69 x 66 x 29.5	125	310	39.75	\$1793	\$362
C3060D4	29.69 x 60 x 29.5	100	297	36.25	\$1718	\$336

Standard with full to floor box/box/file in right pedestal and file/file on left pedestal. Pedestals lock. On box/box/file pedestals, lower box drawer and file drawer lock. One pencil tray. Full to the floor pedestal configurations can be switched for a **15% upcharge**.

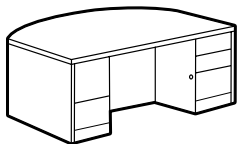

Full to Floor Double Pedestal Bow Top Desk

C4284DB4	38-42 x 84 x 29.5	125	430	70	\$2613	\$567
C3672DB4	32-36 x 72 x 29.5	125	343	52.50	\$2131	\$439

Standard with full to floor box/box/file in right pedestal and file/file on left pedestal. Bow top. Pedestals lock. On box/box/file pedestals, lower box drawer and file drawer lock. One pencil tray. Full to the floor pedestal configurations can be switched for a **15% upcharge**.

- Due to the large size of **C4284DB4**, please consider the clearance of doorways and corridors

SINGLE PEDESTAL DESKS

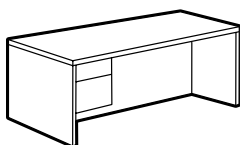

Single Pedestal Desk - LEFT

C3672SPL	36 x 72 x 29.5	150	281	52.50	\$1271	\$439
C3072SPL	29.69 x 72 x 29.5	150	247	43	\$1175	\$362
C3066SPL	29.69 x 66 x 29.5	150	234	39.75	\$1160	\$362
C3060SPL	29.69 x 60 x 29.5	125	222	36.25	\$1085	\$336
C3048SPL	29.69 x 48 x 29.5	125	197	29.25	\$973	\$285
C2448SPL	24 x 48 x 29.5	125	165	24.25	\$973	\$185

Standard with box/file pedestal. Pedestal locks. One pencil tray. Pedestal is on the **left**.

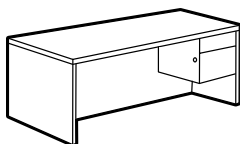

Single Pedestal Desk - RIGHT

C3672SPR	36 x 72 x 29.5	150	281	52.50	\$1271	\$439
C3072SPR	29.69 x 72 x 29.5	150	247	43	\$1175	\$362
C3066SPR	29.69 x 66 x 29.5	150	234	39.75	\$1160	\$362
C3060SPR	29.69 x 60 x 29.5	125	222	36.25	\$1085	\$336
C3048SPR	29.69 x 48 x 29.5	125	197	29.25	\$973	\$285
C2448SPR	24 x 48 x 29.5	125	165	24.25	\$973	\$185

Standard with box/file pedestal. Pedestal locks. One pencil tray. Pedestal is on the **right**.

Required Specifications

Top finish
Base finish
Edge detail

Optional Specifications

Key #
Grommet position or power block cut-out
HP laminate
Modesty panel

Accessories

Power block
Keyboard tray
Pencil tray

SINGLE PEDESTAL DESKS

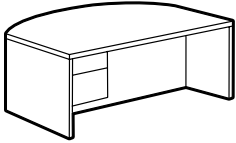

Single Pedestal Bow Top Desk - LEFT

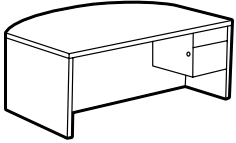

Single Pedestal Bow Top Desk - RIGHT

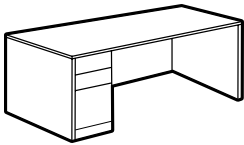

Full to Floor Single Pedestal Desk - LEFT

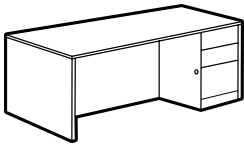

Full to Floor Single Pedestal Desk - RIGHT

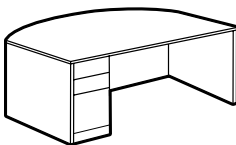

Full to Floor Single Pedestal Bow Top Desk - LEFT

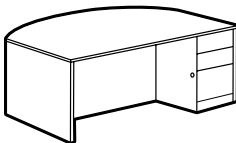

Full to Floor Single Pedestal Bow Top Desk - RIGHT

MODEL#	DIMENSIONS D x W x H	FREIGHT CLASS	WT/LBS.	CUBIC FT.	LIST PRICE	HP ADD
C4284SLB	38-42 x 84 x 29.5	150	345	70	\$1980	\$567
C3672SLB	32-36 x 72 x 29.5	150	267	52.50	\$1495	\$439

Standard with box/file pedestal on **left** and bow top. Pedestal locks. One pencil tray.
 • Due to the large size of **C4284SLB**, please consider the clearance of doorways and corridors

C4284SRB	38-42 x 84 x 29.5	150	345	70	\$1980	\$567
C3672SRB	32-36 x 72 x 29.5	150	267	52.50	\$1495	\$439

Standard with box/file pedestal on **right** and bow top. Pedestal locks. One pencil tray.
 • Due to the large size of **C4284SRB**, please consider the clearance of doorways and corridors

C3672S4L	36 x 72 x 29.5	150	294	52.50	\$1532	\$439
C3072S4L	29.69 x 72 x 29.5	150	260	43.75	\$1476	\$439
C3066S4L	29.69 x 66 x 29.5	125	246	39.75	\$1420	\$362
C3060S4L	29.69 x 60 x 29.5	125	233	36.25	\$1346	\$336
C3048S4L	29.69 x 48 x 29.5	125	209	29.50	\$1123	\$285
C2448S4L	24 x 48 x 29.5	125	180	24.25	\$1123	\$185

Standard with full to floor box/box/file pedestal on the **left**. One pencil tray. Lower box drawer and file drawer lock. One pencil tray. Full to the floor pedestal configurations can be switched for a **15% upcharge**.

C3672S4R	36 x 72 x 29.5	150	294	52.50	\$1532	\$439
C3072S4R	29.69 x 72 x 29.5	150	260	43.75	\$1476	\$439
C3066S4R	29.69 x 66 x 29.5	125	246	39.75	\$1420	\$362
C3060S4R	29.69 x 60 x 29.5	125	233	36.25	\$1346	\$336
C3048S4R	29.69 x 48 x 29.5	125	209	29.50	\$1123	\$285
C2448S4R	24 x 48 x 29.5	125	180	24.25	\$1123	\$185

Standard with full to floor box/box/file pedestal on the **right**. One pencil tray. Lower box drawer and file drawer lock. One pencil tray. Full to the floor pedestal configurations can be switched for a **15% upcharge**.

C4284S4LB	38-42 x 84 x 29.5	150	361	70	\$2240	\$567
C3672S4LB	32-36 x 72 x 29.5	150	279	52.50	\$1755	\$439

Standard with box/box/file pedestal on **left** and bow top. One pencil tray. Lower box drawer and file drawer lock. One pencil tray. Full to the floor pedestal configurations can be switched for a **15% upcharge**.
 • Due to the large size of **C4284S4LB**, please consider the clearance of doorways and corridors

C4284S4RB	38-42 x 84 x 29.5	150	361	70	\$2240	\$567
C3672S4RB	32-36 x 72 x 29.5	150	279	52.50	\$1755	\$439

Standard with box/box/file pedestal on **right** and bow top. One pencil tray. Lower box drawer and file drawer lock. One pencil tray. Full to the floor pedestal configurations can be switched for a **15% upcharge**.
 • Due to the large size of **C4284S4RB**, please consider the clearance of doorways and corridors

Required Specifications

Top finish
 Base finish
 Edge detail

Optional Specifications

Key #
 Grommet position or power block cut-out
 HP laminate
 Modesty panel

Accessories

Power block
 Keyboard tray
 Pencil tray

RETURNS

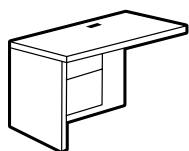

Flush Return - LEFT

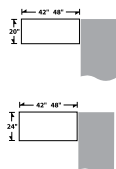

MODEL#	DIMENSIONS D x W x H	FREIGHT CLASS	WT./LBS.	CUBIC FT.	LIST PRICE	HP ADD
C2448FL	24 x 48 x 29.5	125	155	24.50	\$935	\$197
C2442FL	24 x 42 x 29.5	125	144	21.25	\$898	\$165
C2048FL	20 x 48 x 29.5	125	140	20.50	\$898	\$165
C2042FL	20 x 42 x 29.5	125	130	18	\$860	\$165

Standard with box/file drawer pedestal. One pencil tray. Pedestal locks. Grommet in worksurface. Pedestal is on the **left**.

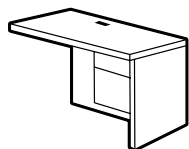

Flush Return - RIGHT

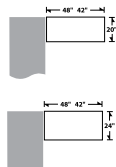

C2448FR	24 x 48 x 29.5	125	155	24.50	\$935	\$197
C2442FR	24 x 42 x 29.5	125	144	21.25	\$898	\$165
C2048FR	20 x 48 x 29.5	125	130	20.50	\$898	\$165
C2042FR	20 x 42 x 29.5	125	130	18	\$860	\$165

Standard with box/file drawer pedestal. One pencil tray. Pedestal locks. Grommet in worksurface. Pedestal is on the **right**.

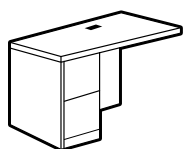

Full to Floor Flush Return - LEFT

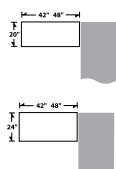

C2448L4	24 x 48 x 29.5	125	171	24.50	\$1123	\$197
C2442L4	24 x 42 x 29.5	125	159	21.50	\$1085	\$165
C2048L4	20 x 48 x 29.5	125	154	20.75	\$1048	\$165
C2042L4	20 x 42 x 29.5	125	144	18.25	\$1010	\$165

Standard with file/file drawer pedestal. One pencil tray. Pedestal locks. Grommet in worksurface. Pedestal is on the **left**. Full to the floor pedestal configurations can be switched for a **15% upcharge**.

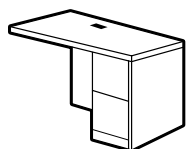

Full to Floor Flush Return - RIGHT

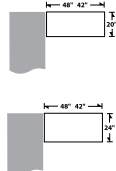

C2448R4	24 x 48 x 29.5	125	171	24.50	\$1123	\$197
C2442R4	24 x 42 x 29.5	125	159	21.50	\$1085	\$165
C2048R4	20 x 48 x 29.5	125	154	20.75	\$1048	\$165
C2042R4	20 x 42 x 29.5	125	144	18.25	\$1010	\$165

Standard with file/file drawer pedestal. One pencil tray. Pedestal locks. Grommet in worksurface. Pedestal is on the **right**. Full to the floor pedestal configurations can be switched for a **15% upcharge**.

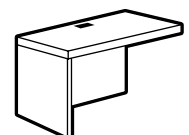

Flush Return - LEFT

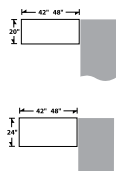

C2448EL	24 x 48 x 29.5	65	107	4.30	\$675	\$197
C2442EL	24 x 42 x 29.5	65	96	3.80	\$638	\$165
C2048EL	20 x 48 x 29.5	65	97	4.30	\$638	\$165
C2042EL	20 x 42 x 29.5	65	86	3.80	\$600	\$165

Return has no pedestal. Grommet in worksurface. Shipped RTA (ready to assemble).

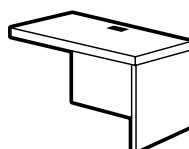

Flush Return - RIGHT

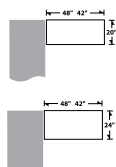

C2448ER	24 x 48 x 29.5	65	107	4.30	\$675	\$197
C2442ER	24 x 42 x 29.5	65	96	3.80	\$638	\$165
C2048ER	20 x 48 x 29.5	65	97	4.30	\$638	\$165
C2042ER	20 x 42 x 29.5	65	86	3.80	\$600	\$165

Return has no pedestal. Grommet in worksurface. Shipped RTA (ready to assemble).

Required Specifications

Top finish
Base finish
Edge detail

Optional Specifications

Key #*
Grommet position or power block cut-out
HP laminate

Accessories

Power block
Keyboard tray
Pencil tray

RETURNS

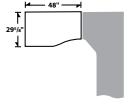
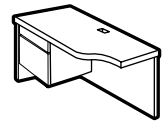

Space Saver Return - LEFT

MODEL#	DIMENSIONS D x W x H	FREIGHT CLASS	WT./LBS.	CUBIC FT.	LIST PRICE	HP ADD
C3048FSL	29.69 x 48 x 29.5	150	166	29.25	\$973	\$285

Standard with box/file pedestal on the **left**, grommet in worksurface. One pencil tray. Pedestal locks. Connects to 24"D 5-sided corner unit and 2466/2472 NFL or NNL extended corner unit.

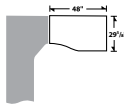
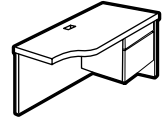

Space Saver Return - RIGHT

C3048FSR	29.69 x 48 x 29.5	150	166	29.25	\$973	\$285
----------	-------------------	-----	-----	-------	--------------	--------------

Standard with box/file pedestal on the **right**, grommet in worksurface. One pencil tray. Pedestal locks. Connects to 24"D 5-sided corner unit and 2466/2472 FNR or NNR extended corner unit.

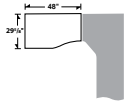
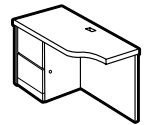

Space Saver Return - LEFT

C3048P4L	29.69 x 48 x 29.5	125	189	29.25	\$1160	\$285
----------	-------------------	-----	-----	-------	---------------	--------------

Standard with file/file pedestal on the **left**, grommet in worksurface. One pencil tray. Pedestal locks. Connects to 24"D 5-sided corner unit and 2466/2472 NFL or NNL extended corner unit.

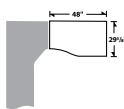
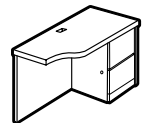

Space Saver Return - RIGHT

C3048P4R	29.69 x 48 x 29.5	125	189	29.25	\$1160	\$285
----------	-------------------	-----	-----	-------	---------------	--------------

Standard with file/file pedestal on the **right**, grommet in worksurface. One pencil tray. Pedestal locks. Connects to 24"D 5-sided corner unit and 2466/2472 FNR or NNR extended corner unit.

FLUSH BRIDGE

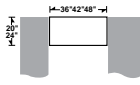
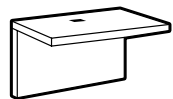

Flush Bridge*

C2448FB	24 x 48 x 29.5	70	91	4.20	\$540	\$197
C2442FB	24 x 42 x 29.5	70	79	3.80	\$502	\$165
C2436FB	24 x 36 x 29.5	70	69	3.30	\$502	\$165
C2048FB	20 x 48 x 29.5	70	83	4.20	\$520	\$165
C2042FB	20 x 42 x 29.5	70	72	3.80	\$480	\$165
C2036FB	20 x 36 x 29.5	70	63	3.30	\$480	\$165

Top surface, back panel and hardware to connect two units. Grommet in worksurface. Shipped RTA (ready to assemble).

CREDENZAS

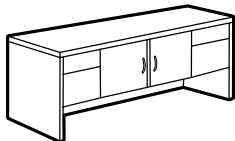

Center Storage Credenza**

C2072C	20 x 72 x 29.5	100	286	30.25	\$1830	\$258
--------	----------------	-----	-----	-------	---------------	--------------

Standard with box/file pedestals on both sides and self-closing hinged center doors covering one adjustable shelf. Pedestals and doors lock. One pencil tray.

• **Please specify handle style when ordering - HU, HV, HW, HX, HS, or HZ**

Required Specifications

Top finish
Base finish
Handles**
Edge detail

Optional Specifications

Key #
Additional grommet position (not C2072C)
HP laminate
Power block cut-out (not C2072C)

Accessories

Power block
Keyboard tray*
Pencil tray*

CRENZAS

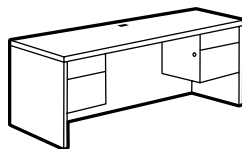

Kneespace Credenza

MODEL#	DIMENSIONS	FREIGHT CLASS	WT./LBS.	CUBIC FT.	LIST PRICE	HP ADD
--------	------------	---------------	----------	-----------	------------	--------

D x W x H

C2472CK	24 x 72 x 29.5	125	262	35.75	\$1532	\$269
C2466CK	24 x 66 x 29.5	125	250	32.75	\$1495	\$269
C2072CK	20 x 72 x 29.5	125	235.07	30.25	\$1420	\$258
C2066CK	20 x 66 x 29.5	100	225	27.75	\$1383	\$248
C2060CK	20 x 60 x 29.5	100	219.09	25.25	\$1346	\$228

Standard with box/file pedestals on both sides. Center is open. Pedestals lock. One pencil tray. Grommet in worksurface.

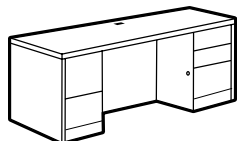

Full to Floor Kneespace Credenza

C2472D4	24 x 72 x 29.5	125	283	35.75	\$1905	\$269
C2466D4	24 x 66 x 29.5	100	272.48	33	\$1867	\$269
C2072D4	20 x 72 x 29.5	100	254	30.50	\$1793	\$258
C2066D4	20 x 66 x 29.5	100	245	28	\$1755	\$248
C2060D4	20 x 60 x 29.5	100	235	25.50	\$1718	\$228

Standard with full to floor box/box/file in right pedestal and file/file on left pedestal. Pedestals lock. On box/box/file pedestals, lower box drawer and file drawer lock. One pencil tray.

- Full to the floor pedestal configurations can be switched for a **15% upcharge**.

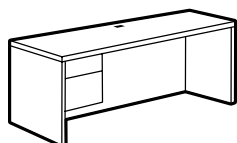

Single Pedestal Credenza - LEFT

C2472CSL	24 x 72 x 29.5	125	215	35.75	\$1234	\$269
C2466CSL	24 x 66 x 29.5	125	204	32.75	\$1196	\$269
C2072CSL	20 x 72 x 29.5	125	192	30.25	\$1123	\$258
C2066CSL	20 x 66 x 29.5	125	182	27.75	\$1085	\$248
C2060CSL	20 x 60 x 29.5	125	173	25.25	\$1048	\$228

Standard with box/file pedestal. Pedestal locks. One pencil tray. Pedestal is on the **left**. Grommet in worksurface.

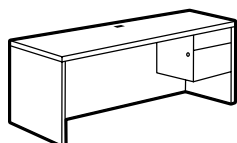

Single Pedestal Credenza - RIGHT

C2472CSR	24 x 72 x 29.5	125	215	35.75	\$1234	\$269
C2466CSR	24 x 66 x 29.5	125	204	32.75	\$1196	\$269
C2072CSR	20 x 72 x 29.5	125	192	30.25	\$1123	\$258
C2066CSR	20 x 66 x 29.5	125	182	27.75	\$1085	\$248
C2060CSR	20 x 60 x 29.5	125	173	25.25	\$1048	\$228

Standard with box/file pedestal. Pedestal locks. One pencil tray. Pedestal is on the **right**. Grommet in worksurface.

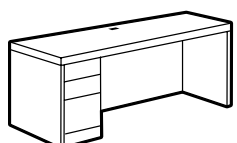

Full to Floor Single Pedestal Credenza- LEFT

C2472S4L	24 x 72 x 29.5	125	228	35.75	\$1458	\$269
C2466S4L	24 x 66 x 29.5	125	217	32.75	\$1420	\$269
C2072S4L	20 x 72 x 29.5	125	203	30.25	\$1346	\$258
C2066S4L	20 x 66 x 29.5	125	197	27.75	\$1309	\$258
C2060S4L	20 x 60 x 29.5	125	184.58	25.75	\$1271	\$228

Standard with full to floor box/box/file pedestal on the **left**. Lower box drawer and file drawer lock. Grommet in worksurface. One pencil tray.

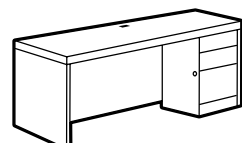

Full to Floor Single Pedestal Credenza- RIGHT

C2472S4R	24 x 72 x 29.5	125	228	35.75	\$1458	\$269
C2466S4R	24 x 66 x 29.5	125	217	32.75	\$1420	\$269
C2072S4R	20 x 72 x 29.5	125	203	30.25	\$1346	\$258
C2066S4R	20 x 66 x 29.5	125	193	27.75	\$1309	\$258
C2060S4R	20 x 60 x 29.5	125	184	25.75	\$1271	\$228

Standard with full to floor box/box/file pedestal on the **right**. Lower box drawer and file drawer lock. Grommet in worksurface. One pencil tray.

Required Specifications

Top finish
Base finish
Edge detail

Optional Specifications

Key #
Grommet position or power block cut-out
HP laminate

Accessories

Power block
Keyboard tray
Pencil tray

CREDENZAS

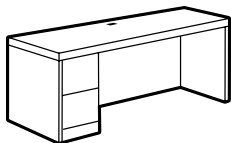

Full to Floor Single Pedestal Credenza- LEFT *

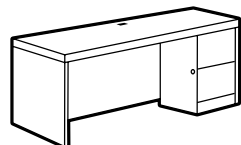

Full to Floor Single Pedestal Credenza- RIGHT *



Lateral File Credenza

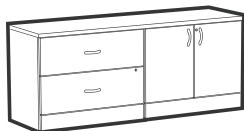

Lateral File/Storage Cabinet Credenza



Knespace Lateral File Credenza - LEFT*

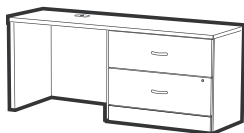

Knespace Lateral File Credenza - RIGHT*

MODEL#	DIMENSIONS D x W x H	FREIGHT CLASS	WT/LBS.	CUBIC FT.	LIST PRICE	HP ADD
C2472S2L	24 x 72 x 29.5	125	228	35.75	\$1458	\$269
C2466S2L	24 x 66 x 29.5	125	217	32.70	\$1420	\$269
C2072S2L	20 x 72 x 29.5	125	203	30.10	\$1346	\$258
C2066S2L	20 x 66 x 29.5	125	194	27.70	\$1309	\$258
C2060S2L	20 x 60 x 29.5	125	184	25.30	\$1271	\$228

Standard with full to floor file/file pedestal on the **left**. Pedestal Locks. Grommet in worksurface.

C2472S2R	24 x 72 x 29.5	125	228	35.75	\$1458	\$269
C2466S2R	24 x 66 x 29.5	60	217	3.70	\$1420	\$269
C2072S2R	20 x 72 x 29.5	125	203	30.10	\$1346	\$258
C2066S2R	20 x 66 x 29.5	125	194	27.70	\$1309	\$258
C2060S2R	20 x 60 x 29.5	125	184	25.70	\$1271	\$228

Standard with full to floor file/file pedestal on the **right**. Pedestal locks. Grommet in worksurface.

C2472LF2	24 x 72 x 29.5	100	345	35.75	\$2113	\$269
C2072LF2	20 x 72 x 29.5	92.5	315	30.25	\$2074	\$258

Two 2-drawer lateral files side-by-side. Locking drawers, keyed alike. File bars included for side-to-side and front-to-back letter/legal filing capability. Anti-lock tilt suspension.

- **Please specify handle style when ordering - HU, HV, HW, HX, HS, or HZ**
- *File drawer construction is for accommodating hanging files NOT for stacking materials on the drawer bottom.*

C2472LS	24 x 72 x 29.5	100	321	35.75	\$1909	\$269
C2072LS	20 x 72 x 29.5	100	286	30.25	\$1869	\$258

One 2-drawer lateral file and one storage cabinet. Locking doors/drawers, keyed alike. Storage cabinet includes one adjustable shelf. File bars included for side-to-side and front-to-back letter/legal filing capability. Anti-lock tilt suspension.

- **Please specify handle style when ordering - HU, HV, HW, HX, HS, or HZ**
- *File drawer construction is for accommodating hanging files NOT for stacking materials on the drawer bottom.*

C2472LKL	24 x 72 x 29.5	125	262	35.75	\$1698	\$269
C2072LKL	20 x 72 x 29.5	125	235	30.25	\$1658	\$258

One 2-drawer lateral file on the **left**. Locking drawers. File bars included for side-to-side and front-to-back letter/legal filing capability. Anti-lock tilt suspension. Grommet in worksurface.

- **Please specify handle style when ordering - HU, HV, HW, HX, HS, or HZ**
- *File drawer construction is for accommodating hanging files NOT for stacking materials on the drawer bottom.*

C2472LKR	24 x 72 x 29.5	125	262	35.75	\$1698	\$269
C2072LKR	20 x 72 x 29.5	125	235	30.25	\$1658	\$258

One 2-drawer lateral file on the **right**. Locking drawers. File bars included for side-to-side and front-to-back letter/legal filing capability. Anti-lock tilt suspension. Grommet in worksurface.

- **Please specify handle style when ordering - HU, HV, HW, HX, HS, or HZ**
- *File drawer construction is for accommodating hanging files NOT for stacking materials on the drawer bottom.*

Required Specifications

Top finish
Base finish
Handles (not C2xxxS2L/C2xxxS2R)
Edge detail

Optional Specifications

Key #
Additional grommet
HP laminate
Power block cut-out*

Accessories

Power block*
Keyboard tray*
Pencil tray*

CRENZAS

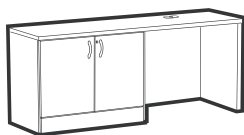

**Kneespace Storage Cabinet Credenza
- LEFT**

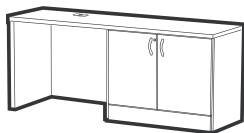

**Kneespace Storage Cabinet Credenza
- RIGHT**

MODEL#	DIMENSIONS	FREIGHT CLASS	WT/LBS.	CUBIC FT.	LIST PRICE	HP ADD
--------	------------	---------------	---------	-----------	------------	--------

D x W x H

C2472SKL	24 x 72 x 29.5	125	241	35.75	\$1379	\$269
C2072SKL	20 x 72 x 29.5	125	207	30.25	\$1338	\$258

One storage cabinet on the **left**. Locking doors. Storage cabinet has one adjustable shelf. Grommet in worksurface.

- **Please specify handle style when ordering - HU, HV, HW, HX, HS, or HZ**

C2472SKR	24 x 72 x 29.5	125	241	35.75	\$1379	\$269
C2072SKR	20 x 72 x 29.5	125	207	30.25	\$1338	\$258

One storage cabinet on the **right**. Locking doors. Storage cabinet has one adjustable shelf. Grommet in worksurface.

- **Please specify handle style when ordering - HU, HV, HW, HX, HS, or HZ**

5-SIDED CORNERS

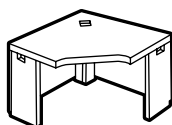

5-Sided Corner*

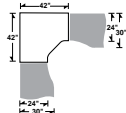

C42245C	42 x 42 x 29.5	65	133	5.78	\$890	\$362
---------	----------------	----	-----	------	--------------	--------------

Connects to **30" D** space saver connectable surfaces, **24" D** connectables, returns and bridges. Grommet in worksurface.

Narrow end panels on left and right. Predrilled to accept MPOKST2 or 22" keyboard trays. **Will not accept keyboard trays wider than 22"**. Shipped RTA (ready to assemble). *Not Freestanding.*

- **Modesty Panel is 1" off of ground.**
- Full End Panel(s) are available - add **15% upcharge**.

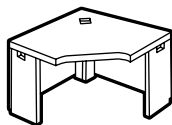

5-Sided Corner*

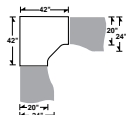

C42205C	42 x 42 x 29.5	70	129	5.75	\$868	\$362
---------	----------------	----	-----	------	--------------	--------------

Connects to **24" D** space saver connectable surfaces, **20" D** returns, lateral files, storage/lateral file credenzas, credenzas,

bridges and end shelves. Grommet in worksurface. Narrow end panels on left and right. Predrilled to accept MPOKST2 or 22-28" keyboard trays. **Will not accept keyboard trays wider than 28"**. Shipped RTA (ready to assemble). *Not freestanding.*

- **Modesty Panel is 1" off of ground.**
- Full End Panel(s) are available - add **15% upcharge**.

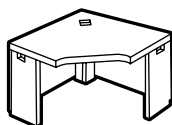

5-Sided Corner*

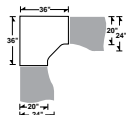

C36205C	36 x 36 x 29.5	65	109	4.75	\$756	\$233
---------	----------------	----	-----	------	--------------	--------------

Connects to **24" D** space saver connectable surfaces, **20" D** returns, lateral files, storage/lateral file credenzas, credenzas,

bridges and end shelves. Grommet in worksurface. Narrow end panels on left and right. Predrilled to accept MPOKST2 or 22" keyboard trays. **Will not accept keyboard trays wider than 22"**. Shipped RTA (ready to assemble). *Not freestanding.*

- **Modesty Panel is 1" off of ground.**
- Full End Panel(s) are available - add **15% upcharge**.

Required Specifications

Top finish
Base finish
Handles (only credenzas)
Edge detail

Optional Specifications

Key #
Additional grommet position
HP laminate
Power block cut-out

Accessories

Power block
Keyboard tray*
Pencil tray

LEFT EXTENDED CORNERS

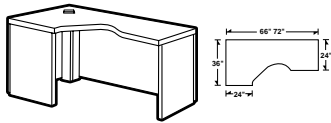

Left Extended Corner - Freestanding

MODEL#	DIMENSIONS	FREIGHT CLASS	WT/LBS.	CUBIC FT.	LIST PRICE	HP ADD
--------	------------	---------------	---------	-----------	------------	--------

D x W x H

C2472FFL	24-36 x 72 x 29.5	65	184	7	\$1105	\$387
C2466FFL	24-36 x 66 x 29.5	65	175	7	\$1063	\$387

Extended worksurface on right. **Full end panels on left and right. Cannot be connected on left or right, due to full end panel.** Corner has one grommet. Predrilled to accept MPOKST2 or 22" keyboard trays. **Will not accept keyboard trays wider than 22"**. Shipped RTA (ready to assemble).

- **Modesty Panel is 1" off of ground.**
- **C2466FFL cannot accept pedestals.**

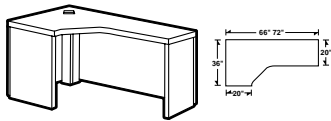

Left Extended Corner

C2072FFL	20-36 x 72 x 29.5	65	171	7	\$1094	\$371
C2066FFL	20-36 x 66 x 29.5	65	164	7	\$1063	\$371

Extended worksurface on right. **Full end panels on left and right. Cannot be connected on left or right, due to full end panel.** Corner has one grommet. Predrilled to accept MPOKST2 or 22" keyboard trays. **Will not accept keyboard trays wider than 22"**. Shipped RTA (ready to assemble).

- **Modesty Panel is 1" off of ground.**

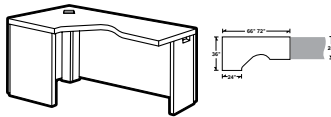

Left Extended Corner

C2472FNL	24-36 x 72 x 29.5	65	175	7	\$1069	\$387
C2466FNL	24-36 x 66 x 29.5	65	167	7	\$1040	\$387

Extended worksurface on right. **Narrow end panel on right. Full end panel on left.** Connects to 30"D space saver connectables, 24"D returns or 24"D connectable tables. **Full end panel cannot be connected.** Corner has one grommet. Predrilled to accept MPOKST2 or 22" keyboard trays. **Will not accept keyboard trays wider than 22"**. Shipped RTA (ready to assemble).

- **Modesty Panel is 1" off of ground.**
- **C2466FNL cannot accept pedestals.**

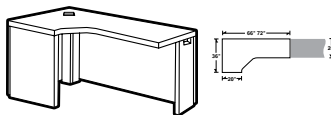

Left Extended Corner

C2072FNL	20-36 x 72 x 29.5	65	165	7	\$1056	\$371
C2066FNL	20-36 x 66 x 29.5	65	158	7	\$1026	\$371

Extended worksurface on right. **Narrow end panel on right. Full end panel on left.** Connects to 24"D space saver connectables, 20"D returns or 20"D connectable tables. **Full end panel cannot be connected.** Corner has one grommet. Predrilled to accept MPOKST2 or 22" keyboard trays. **Will not accept keyboard trays wider than 22"**. Shipped RTA (ready to assemble).

- **Modesty Panel is 1" off of ground.**

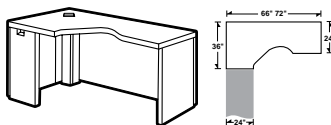

Left Extended Corner

C2472NFL	24-36 x 72 x 29.5	65	175	7	\$1069	\$387
C2466NFL	24-36 x 66 x 29.5	65	167	7	\$1040	\$387

Extended worksurface on right. **Narrow end panel on left. Full end panel on right.** Connects to 30"D space saver connectables, 24"D returns or 24"D connectable tables. **Full end panel cannot be connected.** Corner has one grommet. Predrilled to accept MPOKST2 or 22" keyboard trays. **Will not accept keyboard trays wider than 22"**. Shipped RTA (ready to assemble).

- **Modesty Panel is 1" off of ground.**
- **C2466NFL cannot accept pedestals.**

Required Specifications

Top finish
Base finish
Edge detail

Optional Specifications

Additional grommet
HP laminate
Power block cut-out

Accessories

Power block
Keyboard tray
Pencil tray

LEFT EXTENDED CORNERS

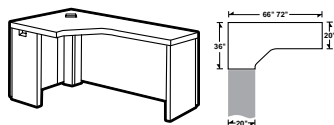

Left Extended Corner

MODEL#	DIMENSIONS	FREIGHT CLASS	WT/LBS.	CUBIC FT.	LIST PRICE	HP ADD
--------	------------	---------------	---------	-----------	------------	--------

D x W x H

C2072NFL	20-36 x 72 x 29.5	65	165	7	\$1056	\$371
C2066NFL	20-36 x 66 x 29.5	65	158	7	\$1026	\$371

Extended worksurface on right. **Narrow end panel on left. Full end panel on right.** Connects to 24"D space saver connectables and 20"D returns. **Full end panel cannot be connected.** Corner has one grommet. Predrilled to accept MPOKST2 or 22" keyboard trays. **Will not accept keyboard trays wider than 22"**. Shipped RTA (ready to assemble).

- Modesty Panel is 1" off of ground.

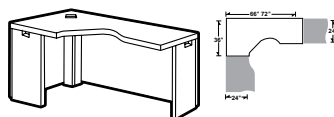

Left Extended Corner

C2472NNL	24-36 x 72 x 29.5	65	166	7	\$1048	\$387
C2466NNL	24-36 x 66 x 29.5	65	158	7	\$1018	\$387

Extended worksurface on right. **Narrow end panels on left and right.** Connects to 30"D space saver connectables, 24"D returns and 24"D connectable tables on either end. Corner has one grommet. Predrilled to accept MPOKST2 or 22" keyboard trays. **Will not accept keyboard trays wider than 22"**. Shipped RTA (ready to assemble).

- Modesty Panel is 1" off of ground.
- C2466NNL cannot accept pedestals.

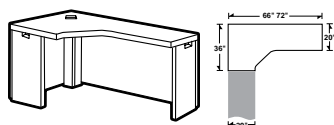

Left Extended Corner

C2072NNL	20-36 x 72 x 29.5	65	160	7	\$1032	\$371
C2066NNL	20-36 x 66 x 29.5	70	152	7	\$1003	\$371

Extended worksurface on right. **Narrow end panels on left and right.** Connects to 24"D space saver connectables and 20"D returns or bridge on either end. Corner has one grommet. Predrilled to accept MPOKST2 or 22" keyboard trays. **Will not accept keyboard trays wider than 22"**. Shipped RTA (ready to assemble).

- Modesty Panel is 1" off of ground.

RIGHT EXTENDED CORNERS

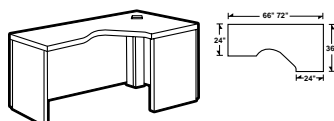

Right Extended Corner - Freestanding

C2472FFR	24-36 x 72 x 29.5	65	184	7	\$1105	\$387
C2466FFR	24-36 x 66 x 29.5	65	175	7	\$1063	\$387

Extended worksurface on left. **Full end panels on left and right. Cannot be connected on left or right, due to full end panel.** Corner has one grommet. Predrilled to accept MPOKST2 or 22" keyboard trays. **Will not accept keyboard trays wider than 22"**. Shipped RTA (ready to assemble).

- Modesty Panel is 1" off of ground.
- C2466FFR cannot accept pedestals.

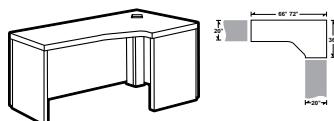

Right Extended Corner

C2072FFR	20-36 x 72 x 29.5	65	171	7	\$1094	\$371
C2066FFR	20-36 x 66 x 29.5	65	164	7	\$1063	\$371

Extended worksurface on left. **Full end panels on left and right. Cannot be connected on left or right, due to full end panel.** Corner has one grommet. Predrilled to accept MPOKST2 or 22" keyboard trays. **Will not accept keyboard trays wider than 22"**. Shipped RTA (ready to assemble).

- Modesty Panel is 1" off of ground.

Required Specifications

Top finish
Base finish
Edge detail

Optional Specifications

Additional grommet
HP laminate
Power block cut-out

Accessories

Power block
Keyboard tray
Pencil tray

RIGHT EXTENDED CORNERS

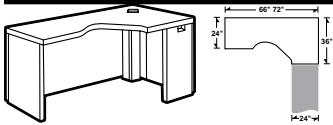

Right Extended Corner

MODEL# DIMENSIONS FREIGHT CLASS WT/LBS. CUBIC FT. LIST PRICE HP ADD

	D x W x H					
C2472FNR	24-36 x 72 x 29.5	65	175	7	\$1069	\$387
C2466FNR	24-36 x 66 x 29.5	65	167	7	\$1040	\$387

Extended worksurface on left. **Narrow end panel on right. Full end panel on left.** Connects to 30"D space saver connectables, 24"D returns or 24"D connectable tables. **Full end panel cannot be connected.** Corner has one grommet. Predrilled to accept MPOKST2 or 22" keyboard trays. **Will not accept keyboard trays wider than 22"**. Shipped RTA (ready to assemble).

- Modesty Panel is 1" off of ground.
- **C2466FNR** cannot accept pedestals.

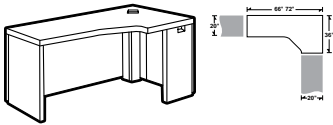

Right Extended Corner

C2072FNR	20-36 x 72 x 29.5	65	165	7	\$1056	\$371
C2066FNR	20-36 x 66 x 29.5	65	158	7	\$1026	\$371

Extended worksurface on left. **Narrow end panel on right. Full end panel on left.** Connects to 24"D space saver connectables, 20"D returns or 20"D connectable tables. **Full end panel cannot be connected.** Corner has one grommet. Predrilled to accept MPOKST2 or 22" keyboard trays. **Will not accept keyboard trays wider than 22"**. Shipped RTA (ready to assemble).

- Modesty Panel is 1" off of ground.

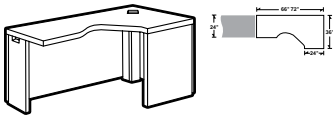

Right Extended Corner

C2472NFR	24-36 x 72 x 29.5	65	175	7	\$1069	\$387
C2466NFR	24-36 x 66 x 29.5	65	167	7	\$1040	\$387

Extended worksurface on left. **Narrow end panel on left. Full end panel on right.** Connects to 30"D space saver connectables, 24"D returns or 24"D connectable tables. **Full end panel cannot be connected.** Corner has one grommet. Predrilled to accept MPOKST2 or 22" keyboard trays. **Will not accept keyboard trays wider than 22"**. Shipped RTA (ready to assemble).

- Modesty Panel is 1" off of ground.
- **C2466NFR** cannot accept pedestals.

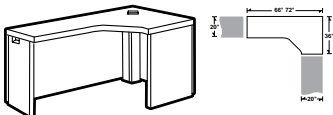

Right Extended Corner

C2072NFR	20-36 x 72 x 29.5	65	165	7	\$1056	\$371
C2066NFR	20-36 x 66 x 29.5	65	158	7	\$1026	\$371

Extended worksurface on left. **Narrow end panel on left. Full end panel on right.** Connects to 24"D space saver connectables and 20"D returns. **Full end panel cannot be connected.** Corner has one grommet. Predrilled to accept MPOKST2 or 22" keyboard trays. **Will not accept keyboard trays wider than 22"**. Shipped RTA (ready to assemble).

- Modesty Panel is 1" off of ground.

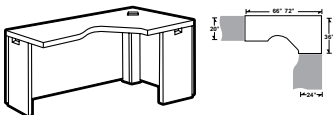

Right Extended Corner

C2472NNR	24-36 x 72 x 29.5	65	166	7	\$1048	\$387
C2466NNR	24-36 x 66 x 29.5	65	158	7	\$1018	\$387

Extended worksurface on left. **Narrow end panels on left and right.** Connects to 30"D space saver connectables, 24"D returns and 24"D connectable tables on either end. Corner has one grommet. Predrilled to accept MPOKST2 or 22" keyboard trays. **Will not accept keyboard trays wider than 22"**. Shipped RTA (ready to assemble).

- Modesty Panel is 1" off of ground.
- **C2466NNR** cannot accept pedestals.

Required Specifications

Top finish
Base finish
Edge detail

Optional Specifications

Additional grommet
HP laminate
Power block cut-out

Accessories

Power block
Keyboard tray
Pencil tray

RIGHT EXTENDED CORNERS

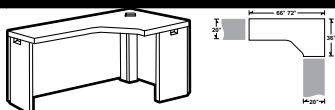

Right Extended Corner

MODEL# DIMENSIONS FREIGHT CLASS WT./LBS. CUBIC FT. LIST PRICE HP ADD

	D x W x H					
C2072NNR	20-36 x 72 x 29.5	65	160	7	\$1032	\$371
C2066NNR	20-36 x 66 x 29.5	70	152	7	\$1003	\$371

Extended worksurface on left. **Narrow end panels on left and right.** Connects to 24"D space saver connectables and 20"D returns or bridge on either end. Corner has one grommet. Predrilled to accept MPOKST2 or 22" keyboard trays. **Will not accept keyboard trays wider than 22"**. Shipped RTA (ready to assemble).

- Modesty Panel is 1" off of ground.

FREESTANDING TABLES

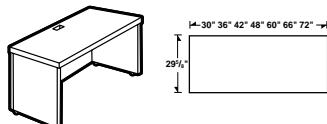

30" Deep Freestanding Table

C3072T	29.69 x 72 x 29.5	65	176	6.25	\$860	\$362
C3066T	29.69 x 66 x 29.5	65	166	6.25	\$825	\$362
C3060T	29.69 x 60 x 29.5	60	159	5.25	\$787	\$336
C3048T	29.69 x 48 x 29.5	65	135	5.25	\$712	\$285
C3042T	29.69 x 42 x 29.5	65	125	5.25	\$675	\$258
C3036T	29.69 x 36 x 29.5	65	111	4.20	\$638	\$233
C3030T	29.69 x 30 x 29.5	65	100	3.60	\$600	\$207

Two full end panels. Cannot be connected on left or right side. Grommet in worksurface. Shipped RTA (ready to assemble).

- Modesty Panel is 1" off of ground

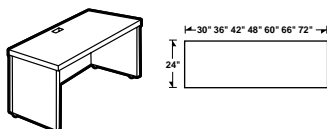

24" Deep Freestanding Table

C2472T	24 x 72 x 29.5	65	152	6.25	\$787	\$269
C2466T	24 x 66 x 29.5	65	144	6.25	\$750	\$269
C2460T	24 x 60 x 29.5	65	133	5.25	\$712	\$248
C2448T	24 x 48 x 29.5	65	114	4.30	\$638	\$197
C2442T	24 x 42 x 29.5	65	105	4.20	\$600	\$165
C2436T	24 x 36 x 29.5	65	95	4.20	\$563	\$124
C2430T	24 x 30 x 29.5	65	85	3.60	\$525	\$124

Two full end panels. Cannot be connected on left or right side. Grommet in worksurface. Shipped RTA (ready to assemble).

- Modesty Panel is 1" off of ground

CONNECTABLE TABLES - LEFT

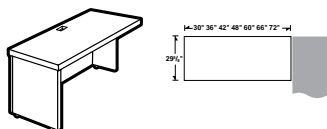

30" Deep Connectable Table - LEFT

C3072L	29.69 x 72 x 29.5	65	168	6.25	\$825	\$362
C3066L	29.69 x 66 x 29.5	65	158	6.25	\$787	\$362
C3060L	29.69 x 60 x 29.5	65	150	5.25	\$750	\$336
C3048L	29.69 x 48 x 29.5	65	124	4.30	\$675	\$285
C3042L	29.69 x 42 x 29.5	65	115	4.30	\$638	\$258
C3036L	29.69 x 36 x 29.5	65	103	4.20	\$600	\$233
C3030L	29.69 x 30 x 29.5	65	92	3.60	\$563	\$207

Full end panel on left. Right narrow end panel connects to 30"D center/right connectable table, or at 90° angle to a freestanding table; and "D" islands or "P" islands with "T" and "H" bases. Grommet in worksurface. Shipped RTA (ready to assemble).

- Modesty Panel is 1" off of ground

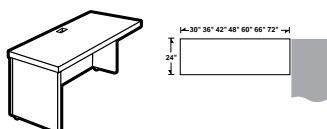

24" Deep Connectable Table - LEFT

C2472L	24 x 72 x 29.5	65	144	6.25	\$750	\$269
C2466L	24 x 66 x 29.5	70	135	6.25	\$712	\$269
C2460L	24 x 60 x 29.5	65	125	5.25	\$675	\$248
C2448L	24 x 48 x 29.5	65	106	4.30	\$600	\$197
C2442L	24 x 42 x 29.5	65	95	3.80	\$563	\$165
C2436L	24 x 36 x 29.5	65	86	3.30	\$525	\$124
C2430L	24 x 30 x 29.5	70	77	3.60	\$489	\$124

Full end panel on left. Right narrow end panel connects to 24"D center/right connectable table, or at 90° angle to a freestanding table; 24"D extended corners, 24" 5-sided corners or at the end of a straight run; "D" islands or "P" islands with "T" and "H" bases. Grommet in worksurface. Shipped RTA (ready to assemble).

- Modesty Panel is 1" off of ground

Required Specifications

Top finish
Base finish
Edge detail

Optional Specifications

Additional grommet
HP laminate
Power block cut-out

Accessories

Power block
Keyboard tray
Pencil tray

CONNECTABLE TABLES - RIGHT

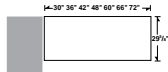
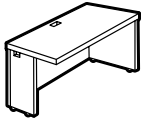

MODEL#	DIMENSIONS	FREIGHT CLASS	WT./LBS.	CUBIC FT.	LIST PRICE	HP ADD
	D x W x H					
C3072R	29.69 x 72 x 29.5	65	168	6.25	\$825	\$362
C3066R	29.69 x 66 x 29.5	65	158	6.25	\$787	\$362
C3060R	29.69 x 60 x 29.5	65	150	5.25	\$750	\$336
C3048R	29.69 x 48 x 29.5	65	124	4.30	\$675	\$285
C3042R	29.69 x 42 x 29.5	65	115	4.20	\$638	\$258
C3036R	29.69 x 36 x 29.5	65	103	4.20	\$600	\$233
C3030R	29.69 x 30 x 29.5	65	91.60	3.60	\$563	\$207

30" Deep Connectable Table - RIGHT

Full end panel on **right**. Left narrow end panel connects to 30"D center/left connectable table, or at 90° angle to a freestanding table; "D" islands or "P" islands with "T" and "H" bases. Grommet in worksurface. Shipped RTA (ready to assemble).

- Modesty Panel is 1" off of ground

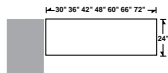
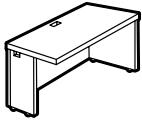

C2472R	24 x 72 x 29.5	65	144	6.25	\$750	\$269
C2466R	24 x 66 x 29.5	70	135	6.25	\$712	\$269
C2460R	24 x 60 x 29.5	65	125	5.25	\$675	\$248
C2448R	24 x 48 x 29.5	65	106	4.30	\$600	\$197
C2442R	24 x 42 x 29.5	65	95	3.80	\$563	\$165
C2436R	24 x 36 x 29.5	65	86	3.30	\$525	\$124
C2430R	24 x 30 x 29.5	70	77	3.60	\$489	\$124

24" Deep Connectable Table - RIGHT

Full end panel on **right**. Left narrow end panel connects to 24"D center/left connectable table, or at 90° angle to a freestanding table; 24"D extended corners, 24" 5-sided corners or at the end of a straight run; "D" islands or "P" islands with "T" and "H" bases. Grommet in worksurface. Shipped RTA (ready to assemble).

- Modesty Panel is 1" off of ground

CONNECTABLE TABLES

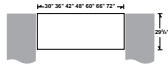
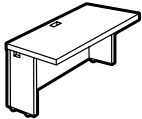

C3072N	29.69 x 72 x 29.5	65	159	6.25	\$787	\$362
C3066N	29.69 x 66 x 29.5	65	149	6.25	\$750	\$362
C3060N	29.69 x 60 x 29.5	65	142	5.25	\$712	\$336
C3048N	29.69 x 48 x 29.5	65	116	4.30	\$638	\$285
C3042N	29.69 x 42 x 29.5	65	106	3.80	\$600	\$258
C3036N	29.69 x 36 x 29.5	65	94	3.30	\$563	\$233
C3030N	29.69 x 30 x 29.5	65	83	3.60	\$525	\$207

30" Deep Connectable Table

Narrow end panels on both sides connects to 30"D worksurfaces; "D" islands or "P" islands with "T" and "H" bases; or at 90° angle to freestanding table(s). Grommet in worksurface. Shipped RTA (ready to assemble).

- Modesty Panel is 1" off of ground

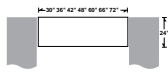
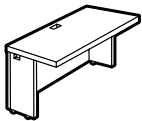

C2472N	24 x 72 x 29.5	70	135	6.25	\$712	\$269
C2466N	24 x 66 x 29.5	70	127	6.25	\$675	\$269
C2460N	24 x 60 x 29.5	70	116	5.25	\$638	\$248
C2448N	24 x 48 x 29.5	65	97	4.30	\$563	\$197
C2442N	24 x 42 x 29.5	65	87	3.80	\$525	\$165
C2436N	24 x 36 x 29.5	65	77	3.30	\$489	\$124
C2430N	24 x 30 x 29.5	70	68	3.60	\$451	\$124

24" Deep Connectable Table

Narrow end panels on both sides connects to 24"D worksurfaces; "D" islands or "P" islands with "T" and "H" bases; or at 90° angle to freestanding table(s). Grommet in worksurface. Shipped RTA (ready to assemble).

- Modesty Panel is 1" off of ground

SPACE SAVER CONNECTABLE TABLES - LEFT

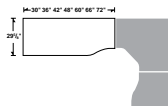
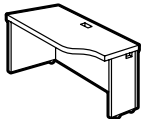

C3072LK	29.69 x 72 x 29	65	161	6.25	\$854	\$362
C3066LK	29.69 x 66 x 29.5	65	151	6.25	\$816	\$362
C3060LK	29.69 x 60 x 29.5	65	144	5.25	\$779	\$336
C3048LK	29.69 x 48 x 29.5	65	118	4.30	\$704	\$285
C3042LK	29.69 x 42 x 29.5	65	107	3.80	\$667	\$258
C3036LK	29.69 x 36 x 29.5	65	96	4.20	\$629	\$233
C3030LK	29.69 x 30 x 29.5	65	85	3.60	\$592	\$207

30" Deep Space Saver Connectable Table - LEFT

Full end panel on left. Narrow right end panel connects to 24"D 5-sided corner unit. Grommet in worksurface. Shipped RTA (ready to assemble).

- Modesty Panel is 1" off of ground
- Keyboard and pencil trays for use on units 42" and above

Required Specifications

Top finish
Base finish
Edge detail

Optional Specifications

Additional grommet
HP laminate
Power block cut-out

Accessories

Power block
Keyboard tray
Pencil tray

SPACE SAVER CONNECTABLE TABLES - LEFT

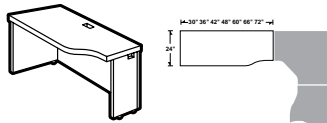

24" Deep Space Saver Connectable Table - LEFT

MODEL#	DIMENSIONS D x W x H	FREIGHT CLASS	WT./LBS.	CUBIC FT.	LIST PRICE	HP ADD
C2472LK	24 x 72 x 29.5	70	140	6.25	\$779	\$269
C2466LK	24 x 66 x 29.5	70	134	6.25	\$741	\$269
C2460LK	24 x 60 x 29.5	65	123	5.25	\$704	\$248
C2448LK	24 x 48 x 29.5	65	104	4.30	\$629	\$197
C2442LK	24 x 42 x 29.5	65	94	3.80	\$592	\$165
C2436LK	24 x 36 x 29.5	65	85	3.30	\$554	\$124
C2430LK	24 x 30 x 29.5	70	75	3.60	\$520	\$124

Full end panel on left. Narrow right end panel connects to 20"D 5-sided corner unit. Grommet in worksurface. Shipped RTA (ready to assemble).

- **Modesty Panel is 1" off of ground.**
- Keyboard and pencil trays for use on units 42" and above

SPACE SAVER CONNECTABLE TABLES - RIGHT

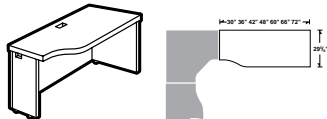

30" Deep Space Saver Connectable Table - RIGHT

C3072RK	29.69 x 72 x 29.5	65	161	6.25	\$854	\$362
C3066RK	29.69 x 66 x 29.5	65	151	6.25	\$816	\$362
C3060RK	29.69 x 60 x 29.5	65	144	5.25	\$779	\$336
C3048RK	29.69 x 48 x 29.5	65	118.86	4.23	\$704	\$285
C3042RK	29.69 x 42 x 29.5	60	107	3.30	\$667	\$258
C3036RK	29.69 x 36 x 29	65	96	4.20	\$629	\$233
C3030RK	29.69 x 30 x 29.5	65	85	3.60	\$592	\$207

Full end panel on right. Narrow right end panel connects to 24"D 5-sided corner unit. Grommet in worksurface. Shipped RTA (ready to assemble).

- **Modesty Panel is 1" off of ground**
- Keyboard and pencil trays for use on units 42" and above

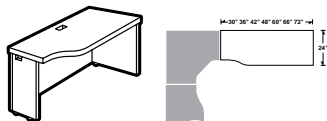

24" Deep Space Saver Connectable Table - RIGHT

C2472RK	24 x 72 x 29.5	65	142	6.25	\$779	\$269
C2466RK	24 x 66 x 29.5	70	134	6.25	\$741	\$269
C2460RK	24 x 60 x 29.5	65	123	5.25	\$704	\$248
C2448RK	30 x 48 x 29.5	65	104	4.30	\$629	\$197
C2442RK	24 x 42 x 29.5	65	94	3.80	\$592	\$165
C2436RK	24 x 36 x 29.5	65	85	3.30	\$554	\$124
C2430RK	24 x 30 x 29.5	70	75	3.60	\$520	\$124

Full end panel on right. Narrow right end panel connects to 20"D 5-sided corner unit. Grommet in worksurface. Shipped RTA (ready to assemble).

- **Modesty Panel is 1" off of ground.**
- Keyboard and pencil trays for use on units 42" and above

SPACE SAVER CONNECTABLE TABLES

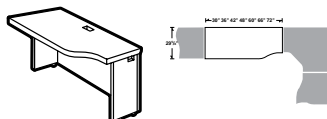

30" Deep Space Saver Connectable Table

C3072LN	29.69 x 72 x 29.5	65	153	6.25	\$816	\$362
C3066LN	29.69 x 66 x 29.5	65	143	6.25	\$779	\$362
C3060LN	29.69 x 60 x 29.5	65	136	5.25	\$741	\$336
C3048LN	29.69 x 48 x 29.5	65	110	4.30	\$667	\$285
C3042LN	29.69 x 42 x 29.5	65	100	3.80	\$629	\$258
C3036LN	29.69 x 36 x 29.5	65	88	3.30	\$592	\$233
C3030LN	29.69 x 30 x 29.5	70	77	3.60	\$554	\$207

Narrow end panels on both sides. Connects the **right end only to 24"D 5-sided corner unit.** Left end allows the continuation of additional connectable center or left connectable worksurface. Grommet in worksurface. Shipped RTA (ready to assemble).

- **Modesty Panel is 1" off of ground.**
- Keyboard and pencil trays for use on units 42" and above

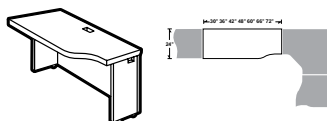

24" Deep Space Saver Connectable Table

C2472LN	24 x 72 x 29.5	70	134	6.25	\$741	\$269
C2466LN	24 x 66 x 29.5	70	125	6.25	\$704	\$269
C2460LN	24 x 60 x 29.5	70	115	5.25	\$667	\$264
C2448LN	24 x 48 x 29.5	70	96	4.30	\$592	\$197
C2442LN	24 x 42 x 29.5	70	85	3.80	\$554	\$165
C2436LN	24 x 36 x 29.5	65	76	3.30	\$520	\$124
C2430LN	24 x 30 x 29.5	70	67	3.60	\$480	\$124

Narrow end panels on both sides. Connects the **right end only to 20"D 5-sided corner unit.** Left end allows the continuation of additional connectable center or left connectable worksurface. Grommet in worksurface. Shipped RTA (ready to assemble). • **Modesty Panel is 1" off of ground.**

- Keyboard and pencil trays for use on units 42" and above

Required Specifications

Top finish
Base finish
Edge detail

Optional Specifications

Additional grommet
HP laminate
Power block cut-out

Accessories

Power block
Keyboard tray
Pencil tray

SPACE SAVER CONNECTABLE TABLES

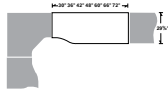
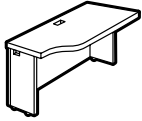

30" Deep Space Saver Connectable Table

MODEL#	DIMENSIONS D x W x H	FREIGHT CLASS	WT./LBS.	CUBIC FT.	LIST PRICE	HP ADD
C3072RN	29.69 x 72 x 29	65	153	6.25	\$816	\$362
C3066RN	29.69 x 66 x 29	65	143	6.25	\$779	\$362
C3060RN	29.69 x 60 x 29.5	65	136	5.25	\$741	\$336
C3048RN	29.69 x 48 x 29.5	65	110	4.30	\$667	\$285
C3042RN	29.69 x 42 x 29.5	65	99	3.80	\$629	\$258
C3036RN	29.69 x 36 x 29.5	65	88	3.30	\$592	\$233
C3030RN	29.69 x 30 x 29.5	70	77	3.60	\$554	\$207

Narrow end panels on both sides. Connects the **left end only to 24"D 5-sided corner unit.** Right end allows the continuation of additional connectable center or right connectable worksurface. Grommet in worksurface. Shipped RTA (ready to assemble).

- **Modesty Panel is 1" off of ground.**
- *Keyboard and pencil trays for use on units 42" and above*

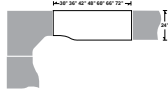
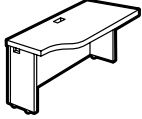

24" Deep Space Saver Connectable Table

C2472RN	24 x 72 x 29.5	70	134	6.25	\$741	\$269
C2466RN	24 x 66 x 29.5	70	125	6.25	\$704	\$269
C2460RN	24 x 60 x 29.5	70	115	5.25	\$667	\$248
C2448RN	24 x 48 x 29.5	70	95	4.23	\$592	\$197
C2442RN	24 x 42 x 29.5	70	85	3.80	\$554	\$165
C2436RN	24 x 36 x 29.5	65	76	3.30	\$520	\$124
C2430RN	24 x 30 x 29.5	70	67	3.60	\$480	\$124

Narrow end panels on both sides. Connects the **left end only to 20"D 5-sided corner unit.** Right end allows the continuation of additional connectable center or right connectable worksurface. Grommet in worksurface. Shipped RTA (ready to assemble).

- **Modesty Panel is 1" off of ground.**
- *Keyboard and pencil trays for use on units 42" and above*

"D" ISLANDS

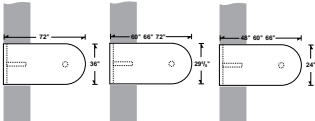
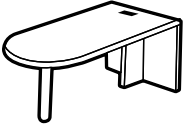

"D" Island - Full End Panel & Post (T-Base)*

C3672FI	36 x 72 x 29.5	85	157	11.60	\$973	\$439
C3072FI	29.69 x 72 x 29.5	70	135	7.76	\$898	\$362
C3066FI	29.69 x 66 x 29.5	70	128	7.76	\$860	\$362
C3060FI	29.69 x 60 x 29.5	70	108	6.76	\$825	\$336
C2466FI	24 x 66 x 29.5	85	111	7.76	\$750	\$269
C2460FI	24 x 60 x 29.5	70	103	6.76	\$712	\$248
C2448FI	24 x 48 x 29.5	70	90	5.76	\$638	\$197

Connects to narrow end panel. Attaching hardware included. Not freestanding. Grommet in worksurface. Shipped RTA (ready to assemble).

- Post is shipped in a separate carton. Standard in Black; Silver is available at no charge, please specify **SIL**.

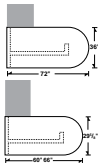
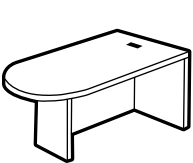

"D" Island LEFT - Full Modesty Panel (H-Base)

C3672FIL	36 x 72 x 29.5	65	171	7	\$973	\$439
C3066FIL	29.69 x 66 x 29.5	70	140	6.25	\$860	\$362
C3060FIL	29.69 x 60 x 29.5	65	128	5.25	\$825	\$336

Connects to the left side of a worksurface. Accommodates all 19" pedestals (freestanding, mobile and hanging pedestals). Grommet in worksurface. Shipped RTA (ready to assemble).

- **Modesty Panel is 1" off of ground.**

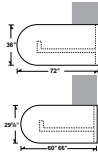
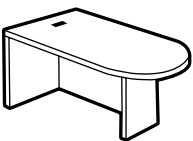

"D" Island RIGHT - Full Modesty Panel (H-Base)

C3672FIR	36 x 72 x 29.5	70	171	7.75	\$973	\$439
C3066FIR	29.69 x 66 x 29.5	65	140	6	\$860	\$362
C3060FIR	29.69 x 60 x 29.5	65	128	5.25	\$825	\$336

Connects to the right side of a worksurface. Accommodates all 19" pedestals (freestanding, mobile and hanging pedestals). Grommet in worksurface. Shipped RTA (ready to assemble).

- **Modesty Panel is 1" off of ground.**

Required Specifications

Top finish
Base finish
Edge detail
Post finish*

Optional Specifications

Additional grommet
HP laminate
Power block cut-out

Accessories

Power block
Keyboard tray
Pencil tray

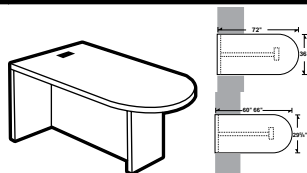
"D" ISLANDS**"D" Island Center - Full Modesty Panel (H-Base)**

MODEL#	DIMENSIONS	FREIGHT CLASS	WT/LBS.	CUBIC FT.	LIST PRICE	HP ADD
--------	------------	---------------	---------	-----------	------------	--------

D x W x H

C3672FIC	36 x 72 x 29.5	65	171	7	\$973	\$439
C3066FIC	29.69 x 66 x 29.5	65	140	6.08	\$860	\$362
C3060FIC	29.69 x 60 x 29.5	65	123	5.26	\$825	\$336

Connects in between two worksurfaces. Will not accommodate pedestals. Grommet in worksurface. Shipped RTA (ready to assemble).

- **Modesty Panel is 1" off of ground.**

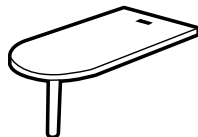
**Attachable "D" Island with Post***

C3672I	36 x 72 x 29.5	85	121	8.18	\$860	\$439
C3066I	29.69 x 66 x 29.5	85	97	7.18	\$750	\$362
C3060I	29.69 x 60 x 29.5	85	88	7	\$712	\$336
C2466I	24 x 66 x 29.5	92.5	84	7.76	\$638	\$269
C2460I	24 x 60 x 29.5	92.5	72.61	6.76	\$600	\$248
C2448I	24 x 48 x 29.5	92.5	63	5.76	\$525	\$197

Attaches to edge of worksurfaces. Attaching hardware included. Grommet in worksurface. Shipped RTA (ready to assemble).

- Post is shipped in a separate carton. Standard in Black; Silver is available at no charge, please specify **SIL**.

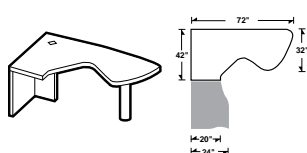
EXTENDED CORNER ISLANDS**Extended Corner Island - RIGHT***

C4272EIR	42-32 x 72 x 29.5	92.5	128	11.50	\$1085	\$516
----------	-------------------	------	-----	-------	---------------	--------------

Extended island worksurface on right. Attaching hardware included. Connects to 20"D returns or 24"D space saver connectables on the left. **Not freestanding.** Predrilled to accept MPOKST2 or 22"-28" keyboard trays. Grommet in worksurface. Shipped RTA (ready to assemble).

- Post is shipped in separate carton. Standard in Black; Silver is available at no charge, please specify **SIL**.

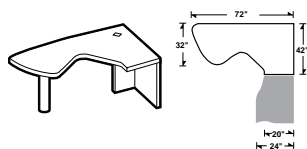
**Extended Corner Island - LEFT***

C4272EIL	42-32 x 72 x 29.5	92.5	128	11.50	\$1085	\$516
----------	-------------------	------	-----	-------	---------------	--------------

Extended island worksurface on left. Attaching hardware included. Connects to 20"D returns or 24"D space saver connectables on the right. **Not freestanding.** Predrilled to accept MPOKST2 or 22"-28" keyboard trays. Grommet in worksurface. Shipped RTA (ready to assemble).

- Post is shipped in separate carton. Standard in Black; Silver is available at no charge, please specify **SIL**.

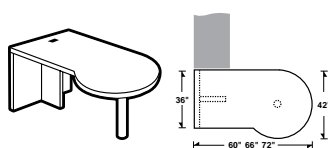
"P" ISLANDS**"P" Island LEFT - Full End Panel & Post (T-Base)***

C3672FPL	42 x 72 x 29	70	163	8.86	\$1085	\$516
C3666FPL	42 x 66 x 29.5	70	155	8.76	\$1048	\$516
C3660FPL	42 x 60 x 29.5	70	145	7.60	\$1010	\$439

Connects to left side of worksurface. Attaching hardware included. **Not freestanding.** Grommet in worksurface. Shipped RTA (ready to assemble).

- Post is shipped in separate carton. Standard in Black; Silver is available at no charge, please specify **SIL**.

Required Specifications

Top finish
Base finish
Edge detail
Post finish*

Optional Specifications

Additional grommet
HP laminate
Power block cut-out

Accessories

Power block
Keyboard tray
Pencil tray

"P" ISLANDS

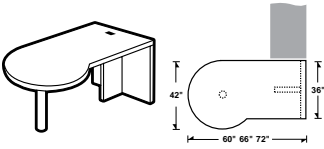

"P" Island RIGHT - Full End Panel & Post (T-Base)*

MODEL#	DIMENSIONS D x W x H	FREIGHT CLASS	WT./LBS.	CUBIC FT.	LIST PRICE	HP ADD
C3672FPR	42 x 72 x 29.5	70	163	9.26	\$1085	\$516
C3666FPR	42 x 66 x 29.5	70	155	8.76	\$1048	\$516
C3660FPR	42 x 60 x 29.5	70	145	7.60	\$1010	\$439

Connects to right side of worksurface. Attaching hardware included. **Not freestanding**. Grommet in worksurface. Shipped RTA (ready to assemble).

- Post is shipped in separate carton. Standard in Black; Silver is available at no charge, please specify **SIL**.

"P" ISLANDS WITH FULL MODESTY PANEL

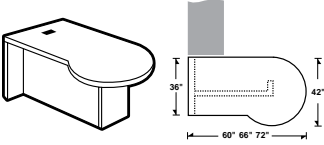

"P" Island LEFT - Full Modesty Panel (H-Base)

C3672PL	42 x 72 x 29.5	65	178	7.75	\$1085	\$516
C3666PL	42 x 66 x 29.5	70	167	7.72	\$1048	\$516
C3660PL	42 x 60 x 29.5	65	155	6.50	\$1010	\$439

Connects to the left side of a worksurface. Accommodates all 19" pedestals (freestanding, mobile and hanging pedestals). Grommet in worksurface. Shipped RTA (ready to assemble).

- **Modesty Panel is 1" off of ground.**

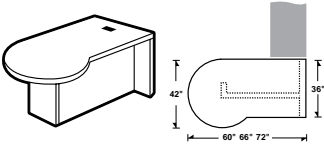

"P" Island RIGHT - Full Modesty Panel (H-Base)

C3672PR	42 x 72 x 29.5	65	177	7.75	\$1085	\$516
C3666PR	42 x 66 x 29.5	65	167	7.25	\$1048	\$516
C3660PR	42 x 60 x 29.5	65	155	6.50	\$1010	\$439

Connects to the right side of a worksurface. Accommodates all 19" pedestals (freestanding, mobile and hanging pedestals). Grommet in worksurface. Shipped RTA (ready to assemble).

- **Modesty Panel is 1" off of ground.**

"P" ISLANDS (ATTACHABLE)

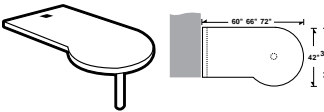

"P" Island LEFT with Post*

C3672IPL	42 x 72 x 29.5	85	128	9	\$973	\$516
C3666IPL	42 x 66 x 29.5	85	119	8.26	\$935	\$516
C3660IPL	42 x 60 x 29.5	85	110	7.76	\$898	\$439

Attaches to edge of worksurfaces. Attaching hardware included. Grommet in worksurface. Shipped RTA (ready to assemble).

- Post is shipped in separate carton. Standard in Black; Silver is available at no charge, please specify **SIL**.

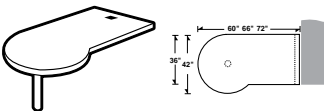

"P" Island RIGHT with Post*

C3672IPR	42 x 72 x 29.5	85	128	9	\$973	\$516
C3666IPR	42 x 66 x 29	85	119	8.26	\$935	\$516
C3660IPR	42 x 60 x 29.5	85	110	7.76	\$898	\$439

Attaches to edge of worksurfaces. Attaching hardware included. Grommet in worksurface. Shipped RTA (ready to assemble).

- Post is shipped in separate carton. Standard in Black; Silver is available at no charge, please specify **SIL**.

RADIUS SPANNER ISLANDS

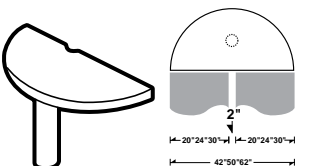

Radius Spanner Island with Panel Cut-Out*

C62RS	31 x 62 x 29.5	85	79	6.26	\$877	\$310
C50RS	25 x 50 x 29.5	92.5	60	5.50	\$764	\$258
C42RS	21 x 42 x 29.5	92.5	53	5.26	\$689	\$207

Used to connect two back-to-back units of same depth with a panel. Includes monopost. Requires "L" bracket (model **MLB90**) for connection to full end panels. Shipped RTA (ready to assemble).

- MLB90 must be ordered separately - see page 517.
- Post is shipped in separate carton. Standard in Black; Silver is available at no charge, please specify **SIL**.
- **Cannot accept keyboard trays or pencil tray**

Required Specifications

Top finish
Base finish
Edge detail
Post finish*

Optional Specifications

Additional grommet
HP laminate
Power block cut-out

Accessories

Power block
Keyboard tray
Pencil tray

RADIUS SPANNER ISLANDS

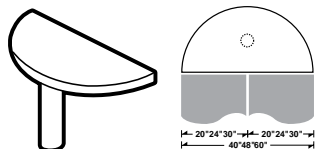

Radius Spanner Island**

MODEL#	DIMENSIONS	FREIGHT CLASS	WT/LBS.	CUBIC FT.	LIST PRICE	HP ADD
	D x W x H					
C60RS	30 x 60 x 29.5	85	76	6.26	\$860	\$258
C48RS	24 x 48 x 29.5	100	56	5.76	\$750	\$207
C40RS	20 x 40 x 29.5	100	51	5.26	\$675	\$207

Used to connect two back-to-back units of same depth. Includes monopost. Requires "L" bracket (model **MLB90**) for connection to full end panels. Shipped RTA (ready to assemble).

- MLB90 must be ordered separately - see page 517.
- Post is shipped in separate carton. Standard in Black; Silver is available at no charge, please specify **SIL**.
- **Cannot accept keyboard trays or pencil tray**

RECEPTION DESKS

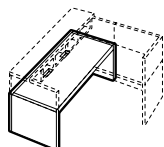

Lower Desk Unit*

C3072RD	29.69 x 72 x 29.5	65	193	7.80	\$935	\$362
---------	-------------------	----	-----	------	--------------	--------------

No pedestals. Two grommets in worksurface. Shipped RTA (ready to assemble).

- Cannot be used with Divide.

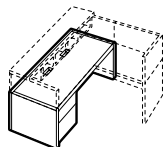

Single Pedestal Lower Desk Unit - LEFT*

C3072RDL	29.69 x 72 x 29.5	150	248	43.75	\$1302	\$362
----------	-------------------	-----	-----	-------	---------------	--------------

Box/file pedestal on **left** with lock. Two grommets in worksurface.

- Cannot be used with Divide.

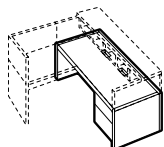

Single Pedestal Lower Desk Unit - RIGHT*

C3072RDR	29.69 x 72 x 29.5	150	248	43.70	\$1302	\$362
----------	-------------------	-----	-----	-------	---------------	--------------

Box/file pedestal on **right** with lock. Two grommets in worksurface.

- Cannot be used with Divide.

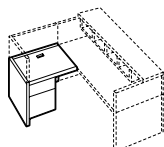

Reception Return - LEFT*

C2442RRL	24 x 42 x 29.5	125	144	21.20	\$838	\$165
----------	----------------	-----	-----	-------	--------------	--------------

Box/file pedestal on **left** with lock. Grommet in worksurface.

- Cannot be used with Divide.
- **Cannot accept keyboard trays or pencil tray**

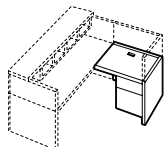

Reception Return - RIGHT*

C2442RRR	24 x 42 x 29.5	125	144	21.20	\$838	\$165
----------	----------------	-----	-----	-------	--------------	--------------

Box/file pedestal on **right** with lock. Grommet in worksurface.

- Cannot be used with Divide.
- **Cannot accept keyboard trays or pencil tray**

Required Specifications

Top finish
Base finish (not radius spanner islands)
Post finish**
Edge detail

Optional Specifications

Additional grommet position*
HP laminate*
Power block cut-out*

Accessories

Power block*
Keyboard tray*
Pencil tray*

RECEPTION DESKS



Reception Return - LEFT*



Reception Return - RIGHT*

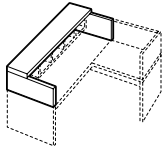

Transaction Counter

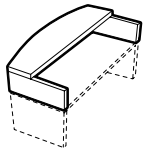

Bow Front Transaction Counter

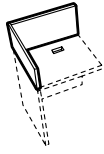

Return Screen Unit - LEFT

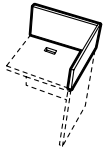

Return Screen Unit - RIGHT

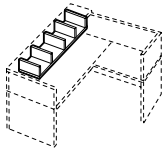

Desk Top Organizer

MODEL#	DIMENSIONS	FREIGHT CLASS	WT/LBS.	CUBIC FT.	LIST PRICE	HP ADD
--------	------------	---------------	---------	-----------	------------	--------

D x W x H

C2442KRL	24 x 42 x 29.5	65	100	3.80	\$638	\$165
----------	----------------	----	-----	------	--------------	--------------

No pedestal. Grommet in worksurface.
 • Cannot be used with Divide.

C2442KRR	24 x 42 x 29.5	65	100	3.80	\$638	\$165
----------	----------------	----	-----	------	--------------	--------------

No pedestal. Grommet in worksurface.
 • Cannot be used with Divide.

C3072URD	30 x 72 x 14.25	70	82	4.30	\$623	\$207
----------	-----------------	----	----	------	--------------	--------------

For main reception desk. To be used on C3072RD, C3072RDL or C3072RDR. Shipped RTA (ready to assemble). Depth of reception top is 12".
 • Reception top units are to be used only with desks listed. Tops have mini-fix fasteners to attach the reception top units.

C3072URB	30-32 x 72 x 14.25	70	89	4.30	\$718	\$258
----------	--------------------	----	----	------	--------------	--------------

For main reception desk. To be used on C3072RD, C3072RDL or C3072RDR. Shipped RTA (ready to assemble). Depth of reception bow top is 12-15".
 • Reception top units are to be used only with desks listed. Tops have mini-fix fasteners to attach the reception top units.

A2442URL	24 x 42 x 12.75	85	27	2	\$245	N/A
----------	-----------------	----	----	---	--------------	-----

To be used on top of left reception return (C2442RRL/KRL). Shipped RTA (ready to assemble).
 • Reception top units are to be used only with returns listed. Tops have mini-fix fasteners to attach the reception top units.

A2442URR	24 x 42 x 12.75	85	27	2	\$245	N/A
----------	-----------------	----	----	---	--------------	-----

To be used on top of right reception return (C2442RRR/KRR). Shipped RTA (ready to assemble).
 • Reception top units are to be used only with returns listed. Tops have mini-fix fasteners to attach the reception top units.

A1172ORD	11 x 52 x 6	100	22	2.60	\$164	N/A
----------	-------------	-----	----	------	--------------	-----

To be used under transaction counter. Black (BK) finish only. Shipped RTA (ready to assemble).

Required Specifications

Top finish
 Base finish
 Edge detail

Optional Specifications

Additional grommet position*
 HP laminate*
 Power block cut-out*

Accessories

Power block*
 Keyboard tray*
 Pencil tray*

WALL/PANEL MOUNT OVERSTORAGE UNITS

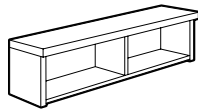

Overstorage Unit**

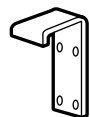

Hanging Bracket

MODEL#	DIMENSIONS D x W x H	FREIGHT CLASS	WT/LBS.	CUBIC FT.	LIST PRICE	HP ADD
COOS60	15 x 60 x 16	70	98.07	5.15	\$689	N/A
COOS48	15 x 48 x 16	70	79	4.23	\$570	N/A
COOS42	15 x 42 x 16	70	72	3.76	\$549	N/A
COOS36	15 x 36 x 16	70	64	3.29	\$480	N/A
COOS30	15 x 30 x 16	70	54	3	\$451	N/A

Standard with pre-mounted "J" bracket for wall mount applications. Can be hung on GPS II panels with optional ABR1 hanging bracket. One fixed shelf, closed back. Uses standard Adaptabilities Hutch Doors. Shipped RTA (ready to assemble).

- **NOTE:** Care should be taken to mount the units. Units should be mounted to wall studs using correct fasteners. Failure to do so may result in collapse of the unit and subsequent personal injury. **Mounting hardware not included.** Mounting hardware used should be based on wall material. Consult an installation professional for proper wall mounting.

ABR1	--	70	1	.01	\$70	N/A
------	----	----	---	-----	-------------	-----

Used to hang overstorage unit on GPS II panels. Accommodates maximum 1 1/2" thick panels. Set includes two hanging brackets, spacing plates and screws

- Additional hardware and panels may be needed for stability. Floor mounts are required for panel installation.

OPEN HUTCHES

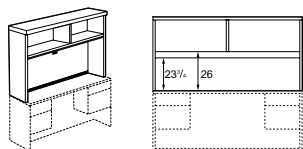

Open Hutch with Closed Back*

C72HOCB	15 x 72 x 42.5	125	203	33	\$973	N/A
C71HOCB	15 x 71.69 x 42.5	125	202	33	\$951	N/A
C66HOCB	15 x 66 x 42.5	125	189	30.59	\$935	N/A
C60HOCB	15 x 60 x 42.5	125	176	27.75	\$860	N/A

One fixed shelf **and fixed shelf divider** (72"-60" hutch). Closed back features a grommet and flexible sweep for wire management. All hutches shipped pre-assembled. ***C71HOCB** for use when spanning 30" x 60/66" SPL/R and 20/24" x 42" FL/FR/L4/R4.

- Clearance from worksurface to valance is 24 1/4"; clearance from worksurface to hutch doors is 26".
- Woodgrain runs horizontal on both the upper and lower back panels.

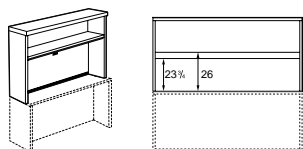

Open Hutch with Closed Back*

C48HOCB	15 x 48 x 42.5	125	143	22.25	\$712	N/A
C42HOCB	15 x 42 x 42.5	125	129	19.50	\$675	N/A
C36HOCB	15 x 36 x 42.5	125	115	17	\$600	N/A
C30HOCB	15 x 30 x 42.5	125	101	14.25	\$554	N/A

One fixed shelf (48"-30" hutch). Closed back features a grommet and flexible sweep for wire management. All hutches shipped pre-assembled.

- Clearance from worksurface to valance is 24 1/4"; clearance from worksurface to hutch doors is 26".
- Woodgrain runs horizontal on both the upper and lower back panels.

PIGEON-HOLE STORAGE

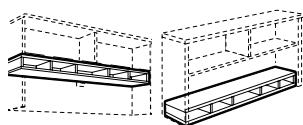

Horizontal Pigeon-Hole Storage

AHS72	11.25 x 70 x 5.62	85	41	3	\$508	N/A
AHS71	11.25 x 69 x 5.62	70	40	2.80	\$508	N/A
AHS66	11.25 x 64 x 5.62	85	38	2.80	\$508	N/A
AHS60	11.25 x 58 x 5.62	85	35	2.50	\$416	N/A
AHS48	11.25 x 46 x 5.62	85	28	2	\$306	N/A
AHS42	11.25 x 40 x 5.62	85	24	2	\$306	N/A
AHS36	11.25 x 34 x 5.62	92.5	22	2	\$250	N/A

For additional storage. Can be **top** or **bottom** mounted. For use inside hutch. Shipped RTA (ready to assemble).

- Cannot be used on AOS and COOS Overstorage Units.
- Black finish is standard. Brushed Cobalt (**BRC**) is available at no charge, please specify.

Required Specifications

Top finish
Base finish*
Edge detail*

Optional Specifications

Doors**

PIGEON-HOLE STORAGE

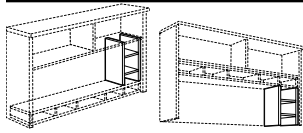

Vertical Pigeon-Hole Storage

MODEL#	DIMENSIONS D x W x H	FREIGHT CLASS	WT./LBS.	CUBIC FT.	LIST PRICE	HP ADD
CVS20	11.25 x 13.37 x 20	70	19	1	\$353	N/A

For use in conjunction with the Horizontal Pigeon-Hole Storage. Can be used under or over horizontal unit. Shipped RTA (ready to assemble).

- Black finish is standard. Brushed Cobalt is available at no charge, please specify as **BRC**.

CORNER HUTCHES

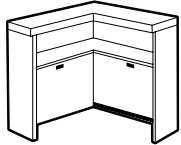

Corner Hutch with Closed Back

C42CH	15 x 42 x 36	65	171	6.25	\$1160	N/A
C36CH	15 x 36 x 42.5	65	150	6.25	\$1010	N/A

One fixed shelf. Closed back features a grommet in both back panels and flexible sweep for wire management. Shipped RTA (ready to assemble).

- Woodgrain runs horizontal on both the upper and lower back panels.

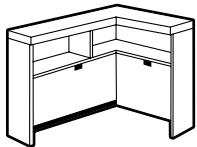

RIGHT Corner Hutch with Closed Back

C3672CHR	15 x .5 x 42.5	60	223	7.08	\$1287	N/A
C3666CHR	15 x 36-66 x 42.5	65	211	7.08	\$1271	N/A

One fixed shelf and shelf divider on **left** side. Closed back features a grommet in both back panels and flexible sweep for wire management on the left side. Shipped RTA (ready to assemble).

- Woodgrain runs horizontal on both the upper and lower back panels.

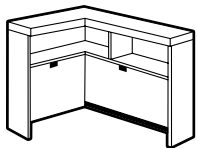

LEFT Corner Hutch with Closed Back

C3672CHL	15 x 36-72 x 42.5	65	223	9.75	\$1287	N/A
C3666CHL	15 x 36-66 x 42.5	65	211	9	\$1271	N/A

One fixed shelf and shelf divider on **right** side. Closed back features a grommet in both back panels and flexible sweep for wire management on the right side. Shipped RTA (ready to assemble).

- Woodgrain runs horizontal on both the upper and lower back panels.

HUTCH DOORS

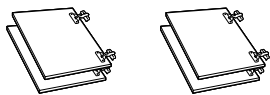

Four-Door Kit*

ADOOR72	.69 x 17.75 x 15	85	25	1.80	\$317	N/A
ADOOR71	.69 x 17.12 x 15	85	25	1.80	\$317	N/A
ADOOR66	.69 x 16.75 x 15	85	24	1.80	\$317	N/A
ADOOR60	.69 x 14.75 x 15	85	22	1.80	\$317	N/A

For use on 72", 71", 66" and 60"W straight hutches. Hinges included. Locks available, ADD **\$95** each lock. Doors for units 60" wide or more require two locks.

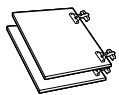

Two-Door Kit*

ADOOR48	.69 x 23.5 x 15	92.5	18	1.80	\$205	N/A
ADOOR42	.69 x 20.5 x 15	100	17	1.80	\$205	N/A
ADOOR36	.69 x 17.5 x 15	100	15	1.80	\$205	N/A
ADOOR30	.69 x 14.5 x 15	125	13	1.80	\$205	N/A

For use on 48", 42" 36" and 30"W straight hutches. Hinges included. Locks available, ADD **\$95** each lock. Doors for units 48" wide or less require one lock.

Required Specifications

- Top finish
- Base finish (only hutches)
- Edge detail

Optional Specifications

- Doors*
- Handles*
- Glazed door*

HUTCH DOORS

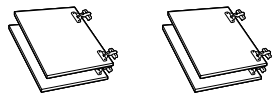

Corner Hutch Four-Door Kit

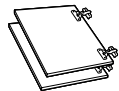

Corner Hutch Two-Door Kit

MODEL#	DIMENSIONS D x W x H	FREIGHT CLASS	WT/LBS.	CUBIC FT.	LIST PRICE	HP ADD
ADOOR72C	.69 x 0 x 15	70	27	1.80	\$403	N/A
ADOOR66C	.69 x 0 x 15	85	25	1.80	\$367	N/A

For use on 72" and 66"W corner hutches. Hinges included. Locks not available on corner hutch doors.

ADOOR42C	.69 x 26.5 x 15	92.5	20	1.80	\$349	N/A
ADOOR36C	.69 x 21.5 x 15	100	17	1.80	\$228	N/A

For use on 42" and 36"W corner hutches. Hinges included. Locks not available on corner hutch doors.

TACKBOARDS FOR HUTCHES

TACKBOARD Notes: Tackboards can be upholstered in all of the following fabrics:

Grade 1: Agate II, Drama, Jenny, Pebbles, Quilt, Sprinkle, Station, Urban

Grade 2: Couture, Crescent, Cumulus, Imprint, Lola, Match, Oxygen, Quantum, Renewal, Replay, Silhouette

Grade 3: Brinx, Mariposa

Grade 4: Accent

Grade 5: Meander, Tracery, Universe

FABRIC GRADE LIST PRICE

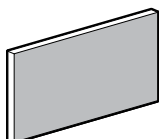

Tackboard

CTB7021	1 x 70 x 21	85	11	.75	1	\$429
					2	\$490
					3	\$539
					4	\$611
					5	\$703

For use on **C72HOCB** straight hutch. Includes mounting screws and covers.

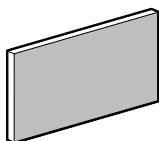

Tackboard

CTB6921	1 x 69 x 21	85	10.70	.75	1	\$429
					2	\$490
					3	\$539
					4	\$611
					5	\$703

For use on **C71HOCB** straight hutch. Includes mounting screws and covers.

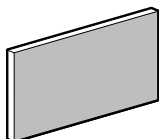

Tackboard

CTB6421	1 x 64 x 21	85	10	.75	1	\$368
					2	\$417
					3	\$456
					4	\$515
					5	\$593

For use on **C66HOCB** straight hutch. Includes mounting screws and covers.

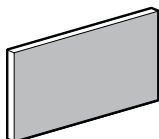

Tackboard

CTB5821	1 x 58 x 21	85	9	.75	1	\$362
					2	\$411
					3	\$450
					4	\$508
					5	\$585

For use on **C60HOCB** straight hutch. Includes mounting screws and covers.

Required Specifications

Fabric (tackboards)

TACKBOARDS FOR HUTCHES

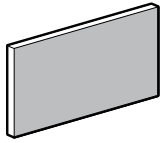

Tackboard

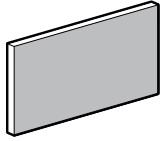

Tackboard

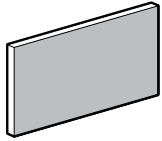

Tackboard

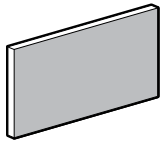

Tackboard

MODEL#	DIMENSIONS	FREIGHT CLASS	WT/LBS.	CUBIC FT.	FABRIC GRADE	LIST PRICE
--------	------------	---------------	---------	-----------	--------------	------------

	D x W x H					
CTB4621	1 x 46 x 21	85	7.20	.50	1	\$254
					2	\$291
					3	\$320
					4	\$363
					5	\$418

For use on **C48HOCB** straight hutch. Includes mounting screws and covers.

CTB4021	1 x 40 x 21	85	6.20	.51	1	\$237
					2	\$274
					3	\$304
					4	\$346
					5	\$398

For use on **C42HOCB** straight hutch. Includes mounting screws and covers.

CTB3421	1 x 34 x 21	92.5	5.50	.50	1	\$229
					2	\$260
					3	\$285
					4	\$320
					5	\$368

For use on **C36HOCB** straight hutch. Includes mounting screws and covers.

CTB2821	1 x 28 x 21	100	4.50	.50	1	\$229
					2	\$260
					3	\$285
					4	\$320
					5	\$368

For use on **C30HOCB** straight hutch. Includes mounting screws and covers.

TACKBOARDS FOR CORNER HUTCHES

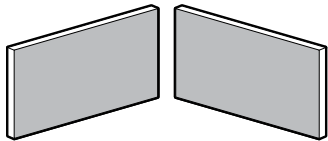

Tackboard

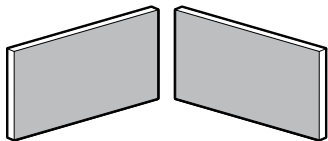

Tackboard

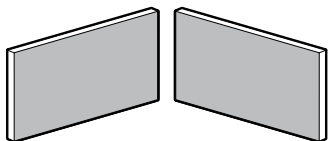

Tackboard

CTB72CH	1 x 33-72 x 21	92.5	16	1.53	1	\$654
					2	\$734
	70 w x 15¾ h				3	\$800
					4	\$894
					5	\$1029

For use on **C3672CHR/L** corner hutch. Includes mounting screws and covers.

CTB66CH	1 x 33-64 x 21	100	15	1.53	1	\$596
					2	\$677
	64 w x 15¾ h				3	\$740
					4	\$838
					5	\$964

For use on **C3666CHR/L** corner hutch. Includes mounting screws and covers.

CTB42CH	1 x 39-40 x 21	92.5	11	1.02	1	\$471
					2	\$537
					3	\$587
					4	\$665
					5	\$765

For use on **C42CH** corner hutch. Includes mounting screws and covers.

Required Specifications

Fabric (tackboards)

TACKBOARDS FOR CORNER HUTCHES

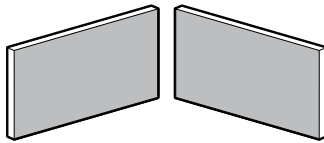

Tackboard

MODEL#	DIMENSIONS D x W x H	FREIGHT CLASS	WT/LBS.	CUBIC FT.	FABRIC GRADE	LIST PRICE
CTB36CH	1 x 33-34 x 21	92.5	10.60	1.01	1	\$455
					2	\$513
					3	\$556
					4	\$623
					5	\$717

For use on C36CH corner hutch. Includes mounting screws and covers.

WALL MOUNTED TACKBOARDS

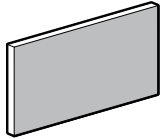

Wall Mounted Tackboard

CWHT3025	1.25 x 30 x 25	100	8.30	1	1	\$240
					2	\$276
					3	\$317
					4	\$364
					5	\$419

For use under **COOS30** overstorage unit. Standard with pre-mounted "J" bracket for wall mount applications. There will be a .75" clearance between the top of the tackboard and bottom of the overhead, and a .25" clearance between the bottom of the tackboard and the worksurface.

- **NOTE:** Care should be taken to mount the units. Units should be mounted to wall studs using correct fasteners. Failure to do so may result in collapse of the unit and subsequent personal injury. **Mounting hardware not included.** Mounting hardware used should be based on wall material. Consult an installation professional for proper wall mounting.

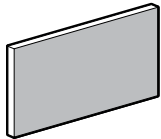

Wall Mounted Tackboard

CWHT3625	1.25 x 36 x 25	92.5	10	1	1	\$266
					2	\$306
					3	\$352
					4	\$405
					5	\$465

For use under **COOS36** overstorage unit. Standard with pre-mounted "J" bracket for wall mount applications. There will be a .75" clearance between the top of the tackboard and bottom of the overhead, and a .25" clearance between the bottom of the tackboard and the worksurface.

- **NOTE:** Care should be taken to mount the units. Units should be mounted to wall studs using correct fasteners. Failure to do so may result in collapse of the unit and subsequent personal injury. **Mounting hardware not included.** Mounting hardware used should be based on wall material. Consult an installation professional for proper wall mounting.

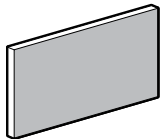

Wall Mounted Tackboard

CWHT4225	1.25 x 42 x 25	92.5	11.70	1	1	\$309
					2	\$355
					3	\$408
					4	\$469
					5	\$539

For use under **COOS42** overstorage unit. Standard with pre-mounted "J" bracket for wall mount applications. There will be a .75" clearance between the top of the tackboard and bottom of the overhead, and a .25" clearance between the bottom of the tackboard and the worksurface.

- **NOTE:** Care should be taken to mount the units. Units should be mounted to wall studs using correct fasteners. Failure to do so may result in collapse of the unit and subsequent personal injury. **Mounting hardware not included.** Mounting hardware used should be based on wall material. Consult an installation professional for proper wall mounting.

Required Specifications

Fabric (tackboards)

WALL MOUNTED TACKBOARDS

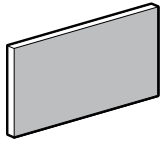

Wall Mounted Tackboard

MODEL#	DIMENSIONS D x W x H	FREIGHT CLASS	WT/LBS.	CUBIC FT.	FABRIC GRADE	LIST PRICE
CWHT4825	1.25 x 48 x 25	100	8.30	1	1	\$335
					2	\$385
					3	\$443
					4	\$509
					5	\$586

For use under **COOS48** overstorage unit. Standard with pre-mounted "J" bracket for wall mount applications. There will be a .75" clearance between the top of the tackboard and bottom of the overhead, and a .25" clearance between the bottom of the tackboard and the worksurface.

- **NOTE:** Care should be taken to mount the units. Units should be mounted to wall studs using correct fasteners. Failure to do so may result in collapse of the unit and subsequent personal injury. **Mounting hardware not included.** Mounting hardware used should be based on wall material. Consult an installation professional for proper wall mounting.

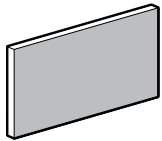

Wall Mounted Tackboard

CWHT6025	1.25 x 60 x 25	100	16.70	1.80	1	\$415
					2	\$477
					3	\$548
					4	\$630
					5	\$725

For use under **COOS60** overstorage unit. Standard with pre-mounted "J" bracket for wall mount applications. There will be a .75" clearance between the top of the tackboard and bottom of the overhead, and a .25" clearance between the bottom of the tackboard and the worksurface.

- **NOTE:** Care should be taken to mount the units. Units should be mounted to wall studs using correct fasteners. Failure to do so may result in collapse of the unit and subsequent personal injury. **Mounting hardware not included.** Mounting hardware used should be based on wall material. Consult an installation professional for proper wall mounting.

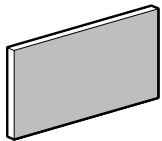

Wall Mounted Tackboard

CWHT6625	1.25 x 66 x 25	92.5	18.30	1.80	1	\$441
					2	\$507
					3	\$583
					4	\$670
					5	\$771

For use under **multiple** Correlation wall mounted overstorage units. Standard with pre-mounted "J" bracket for wall mount applications. There will be a .75" clearance between the top of the tackboard and bottom of the overhead, and a .25" clearance between the bottom of the tackboard and the worksurface.

- **NOTE:** Care should be taken to mount the units. Units should be mounted to wall studs using correct fasteners. Failure to do so may result in collapse of the unit and subsequent personal injury. **Mounting hardware not included.** Mounting hardware used should be based on wall material. Consult an installation professional for proper wall mounting.

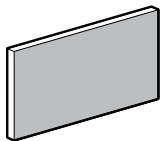

Wall Mounted Tackboard

CWHT7225	1.25 x 72 x 25	92.5	20	1.80	1	\$484
					2	\$556
					3	\$639
					4	\$735
					5	\$845

For use under **multiple** Correlation wall mounted overstorage units. Standard with pre-mounted "J" bracket for wall mount applications. There will be a .75" clearance between the top of the tackboard and bottom of the overhead, and a .25" clearance between the bottom of the tackboard and the worksurface.

- **NOTE:** Care should be taken to mount the units. Units should be mounted to wall studs using correct fasteners. Failure to do so may result in collapse of the unit and subsequent personal injury. **Mounting hardware not included.** Mounting hardware used should be based on wall material. Consult an installation professional for proper wall mounting.

Required Specifications
Fabric

WALL MOUNTED TACKBOARDS

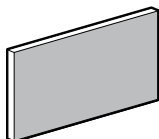

Wall Mounted Tackboard*

MODEL#	DIMENSIONS	FREIGHT CLASS	WT/LBS.	CUBIC FT.	FABRIC GRADE	LIST PRICE
CWHT7825	1.25 x 78 x 25	85	21.70	1.80	1	\$510
					2	\$587
					3	\$674
					4	\$775
					5	\$891

D x W x H

MODEL#	DIMENSIONS	FREIGHT CLASS	WT/LBS.	CUBIC FT.	FABRIC GRADE	LIST PRICE
CWHT8425	1.25 x 84 x 25	85	23.30	1.80	1	\$553
					2	\$636
					3	\$731
					4	\$840
					5	\$966

For use under **multiple** Correlation wall mounted overstorage units. Standard with pre-mounted "J" bracket for wall mount applications. There will be a .75" clearance between the top of the tackboard and bottom of the overhead, and a .25" clearance between the bottom of the tackboard and the worksurface.

- **NOTE:** Care should be taken to mount the units. Units should be mounted to wall studs using correct fasteners. Failure to do so may result in collapse of the unit and subsequent personal injury. **Mounting hardware not included.** Mounting hardware used should be based on wall material. Consult an installation professional for proper wall mounting.

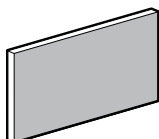

Wall Mounted Tackboard*

MODEL#	DIMENSIONS	FREIGHT CLASS	WT/LBS.	CUBIC FT.	FABRIC GRADE	LIST PRICE
CWHT8425	1.25 x 84 x 25	85	23.30	1.80	1	\$553
					2	\$636
					3	\$731
					4	\$840
					5	\$966

For use under **multiple** Correlation wall mounted overstorage units. Standard with pre-mounted "J" bracket for wall mount applications. There will be a .75" clearance between the top of the tackboard and bottom of the overhead, and a .25" clearance between the bottom of the tackboard and the worksurface.

- **NOTE:** Care should be taken to mount the units. Units should be mounted to wall studs using correct fasteners. Failure to do so may result in collapse of the unit and subsequent personal injury. **Mounting hardware not included.** Mounting hardware used should be based on wall material. Consult an installation professional for proper wall mounting.

ACCESSORY PIECES

LIST PRICE HP ADD



Mixed Drawer Cabinet - LEFT**

C2036MDL	20 x 36 x 29.5	92.5	171	15.50	\$1630	\$124
C2436MDL	24 x 36 x 29.5	92.5	188	18.25	\$1653	\$124

Two box drawers on **right**, one file drawer on **left** and one lateral file drawer on bottom. File on lateral file drawers locking. 1 pencil tray. Front-to-back filing bars.

- **Please specify handle style when ordering - HU, HV, HW, HX, HS, or HZ**
- To comply with ANSI/BIFMA stability tests, the Lateral File Counter Weight Kit (model LFCWKIT36 - pg. 75) MUST be used.
- *File drawer construction is for accommodating hanging files NOT for stacking materials on the drawer bottom.*



Mixed Drawer Cabinet - RIGHT**

C2036MDR	20 x 36 x 29.5	92.5	171	15.50	\$1630	\$124
C2436MDR	24 x 36 x 29.5	92.5	188	18.25	\$1653	\$124

Two box drawers on **left**, one file drawer on **right** and one lateral file drawer on bottom. File on lateral file drawers locking. 1 pencil tray. Front-to-back filing bars.

- **Please specify handle style when ordering - HU, HV, HW, HX, HS, or HZ**
- To comply with ANSI/BIFMA stability tests, the Lateral File Counter Weight Kit (model LFCWKIT36 - pg. 75) MUST be used.
- *File drawer construction is for accommodating hanging files NOT for stacking materials on the drawer bottom.*

Required Specifications

Fabric*
Top finish**
Handle finish
Base finish

Optional Specifications

Edge
Key # (not tackboard)

ACCESSORY PIECES



Mixed Drawer Cabinet Shell - LEFT

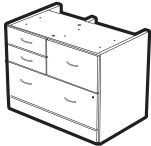

Mixed Drawer Cabinet Shell - LEFT

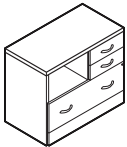

Mixed Storage Cabinet

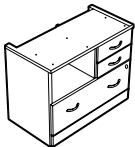

Mixed Storage Cabinet Shell



2 Drawer Lateral File

MODEL#	DIMENSIONS D x W x H	FREIGHT CLASS	WT/LBS.	CUBIC FT.	LIST PRICE	HP ADD
C2036MDLS	19.25 x 36 x 28	100	137	15	\$1490	N/A
C2436MDLS	23.25 x 36 x 28	100	150	18	\$1515	N/A

For use under 29.5"H limited single pedestal desks, workstations or limited single pedestal credenzas. Unfinished top, no back. Two box drawers on right, one file drawer on left and one lateral file drawer on bottom. File and lateral file drawers locking. 1 pencil tray. Front-to-back filing bars.

- Please specify handle style when ordering - HU, HV, HW, HX, HS, or HZ
- File drawer construction is for accommodating hanging files NOT for stacking materials on the drawer bottom.
- For 24" deep worksurfaces, order C2436MDLS. For 20" deep worksurfaces, order C2036MDLS.

C2036MDRS	19.25 x 36 x 28	100	137	15	\$1490	N/A
C2436MDRS	23.25 x 36 x 28	100	150	18	\$1515	N/A

For use under 29.5"H limited single pedestal desks, workstations or limited single pedestal credenzas. Unfinished top, no back. Two box drawers on left, one file drawer on right and one lateral file drawer on bottom. File and lateral file drawers locking. 1 pencil tray. Front-to-back filing bars.

- Please specify handle style when ordering - HU, HV, HW, HX, HS, or HZ
- File drawer construction is for accommodating hanging files NOT for stacking materials on the drawer bottom.
- For 24" deep worksurfaces, order C2436MDRS. For 20" deep worksurfaces, order C2036MDRS.

C2436MSC	24 x 36 x 29.5	100	173	18.25	\$1383	\$124
C2036MSC	20 x 36 x 29.5	92.5	155	15.50	\$1346	\$124

Features open storage compartment with access grommet on back. 2 box drawers and 1 lateral file drawer, all locking. 1 pencil tray. Front-to-back filing bars.

- To comply with ANSI/BIFMA stability tests, the Lateral File Counter Weight Kit (model LFCWKIT36 - pg. 75) MUST be used.
- Please specify handle style when ordering - HU, HV, HW, HX, HS, or HZ
- File drawer construction is for accommodating hanging files NOT for stacking materials on the drawer bottom.

C2436MSCS	23.25 x 36 x 28.5	100	157	18.60	\$1123	N/A
C2036MSCS	19.25 x 36 x 28.5	100	130	15.90	\$1085	N/A

For use under 29.5"H limited single pedestal desks, workstations or limited single pedestal credenzas. Unfinished top, no back. Features open storage compartment with access grommet on back. 2 box drawers and 1 lateral file drawer, all locking. 1 pencil tray. Front-to-back filing bars.

- Please specify handle style when ordering - HU, HV, HW, HX, HS, or HZ
- File drawer construction is for accommodating hanging files NOT for stacking materials on the drawer bottom.
- For 24" deep worksurfaces, order C2436MSCS. For 20" deep worksurfaces, order C2036MSCS.

C2036LF	20 x 36 x 29.5	92.5	155	15.50	\$1085	\$124
---------	----------------	------	-----	-------	--------	-------

Two full suspension drawers. Front-to-back and side-to-side letter/legal filing capability with lock. Anti-lock tilt suspension.

- To comply with ANSI/BIFMA stability tests, the Lateral File Counter Weight Kit (model LFCWKIT36 - pg. 75) MUST be used.
- Please specify handle style when ordering - HU, HV, HW, HX, HS, or HZ
- File drawer construction is for accommodating hanging files NOT for stacking materials on the drawer bottom.

Required Specifications

Top finish
Base finish (not shells)
Handles
Edge detail*

Optional Specifications

Key #
HP laminate (not shells)

ACCESSORY PIECES

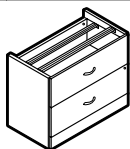

2 Drawer Lateral File Shell

MODEL#	DIMENSIONS D x W x H	FREIGHT CLASS	WT/LBS.	CUBIC FT.	LIST PRICE	HP ADD
C2436S2	24 x 36 x 28	125	114	17.75	\$1189	N/A
C2036S2	20 x 36 x 28	125	104	15	\$1175	N/A

For use **under 29.5"H limited single pedestal desks, workstations or limited single pedestal credenzas. No top or back.** Two full suspension locking drawers with **steel drawer interior.** Side-to-side file bars included. Anti-lock tilt suspension.

- **Please specify handle style when ordering - HU, HV, HW, HX, HS, or HZ**
- For 24" deep worksurfaces, order **C2436S2.** For 20" deep worksurfaces, order **C2036S2.**
- For front-to-back file bars order **FBB;** page 699.

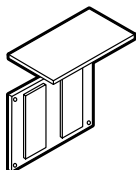

2 Drawer Lateral File Top and Back

CLF24TB	24 x 36 x 29.5	65	93	3.30	\$466	\$156
CLF20TB	20 x 36 x 29.5	65	88	3.30	\$451	\$156

For use with Lateral File Shell. Counterweights included. Shipped RTA (ready to assemble).

- Use **CLF24TB** for model C2436S2. Use **CLF20TB** for model C2036S2.

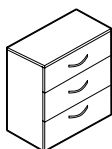

3 Drawer Lateral File

C2036S3	20 x 36 x 38.25	92.5	228	20	\$1822	\$124
---------	-----------------	------	-----	----	---------------	--------------

Three full suspension locking drawers with **steel drawer interior.** Side-to-side file bars included. Anti-lock tilt suspension.

- **Please specify handle style when ordering - HU, HV, HW, HX, HS, or HZ**
- For front-to-back file bars order **FBB;** see page 699.

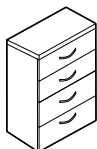

4 Drawer Lateral File

C2036S4	20 x 36 x 50	92.5	277	26	\$2240	\$124
---------	--------------	------	-----	----	---------------	--------------

Four full suspension locking drawers with **steel drawer interior.** Side-to-side file bars included. Anti-lock tilt suspension.

- **Please specify handle style when ordering - HU, HV, HW, HX, HS, or HZ**
- For front-to-back file bars order **FBB;** see page 699.

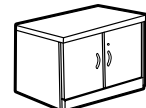

Storage Cabinet

C2036SC	20 x 36 x 29.5	100	131	15.50	\$838	\$124
---------	----------------	-----	-----	-------	--------------	--------------

Self-closing hinged doors cover one adjustable shelf. Standard with lock.

- **Please specify handle style when ordering - HU, HV, HW, HX, HS, or HZ**

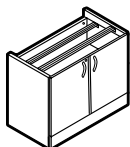

Storage Cabinet Shell

C2436SCS	23.25 x 36 x 28	150	106	18	\$802	N/A
C2036SCS	19.25 x 36 x 28	125	93	15	\$764	N/A

For use **under 29"H limited single pedestal desks, workstations or limited single pedestal credenzas. No top or back.** Self-closing hinged doors cover one adjustable shelf. Standard with lock.

- **Please specify handle style when ordering - HU, HV, HW, HX, HS, or HZ**
- For 24" deep worksurfaces, order **C2436SCS.** For 20" deep worksurfaces, order **C2036SCS.**

Required Specifications

Top finish
Base finish (not shells)
Handles
Edge detail (not C2xxxCS)

Optional Specifications

Key #
HP laminate

ACCESSORY PIECES

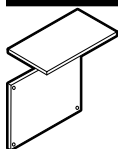

Storage Cabinet Top and Back

MODEL#	DIMENSIONS D x W x H	FREIGHT CLASS	WT/LBS.	CUBIC FT.	LIST PRICE	HP ADD
CSC24TB	24 x 36 x 29.5	70	60	3.30	\$353	\$156
CSC20TB	20 x 36 x 29.5	70	55	3.30	\$339	\$156

For use with **Storage Cabinet Shell**. Shipped RTA (ready to assemble).

- Use **CSC24TB** for model C2436SCS/MSCS; use **CSC20TB** for model C2036SCS/MSCS.

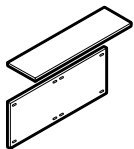

Credenza Top and Back

C2472TB	24 x 72 x 29.5	70	117	5.90	\$689	\$269
C2072TB	20 x 72 x 29	70	106	6	\$675	\$258

For use with the following: **two Lateral File Shells**, or **two Storage Cabinet Shells**, or **two Mixed Storage Cabinet Shells**, or any combination. May also be used with **one Lateral File Shell plus one Full Leg**, or **one Storage Cabinet/ Mixed Storage Cabinet Shell plus one Full Leg**. Shipped RTA (ready to assemble).

- For 24" deep worksurfaces, order **C2472TB**. For 20" deep worksurfaces, order **C2072TB**.

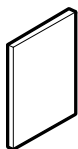

Full Leg

A24FL	24 x 1 x 28	92.5	20	1.70	\$189	N/A
A20FL	20 x 1 x 28	65	16	.60	\$189	N/A

For use at **either end of C24/2072TB Credenza Top and Back** to create a kneespace. Non-handed; can be used left or right. Shipped RTA (ready to assemble).

- For 24" deep worksurfaces, order **A24FL**. For 20" deep worksurfaces, order **A20FL**.



Personal Tower

C24PTFF	24 x 24 x 72	100	246	29.75	\$2091	N/A
C20PTFF	20 x 24 x 72	100	222	25	\$2091	N/A

Includes 7" wardrobe section with a hanging rod; storage section with one adjustable shelf; and file section with **two file drawers**. Locks are keyed alike. Upper lock secures wardrobe and storage section. Lower lock secures both file drawers.

- **Please specify handle style when ordering - HU, HV, HW, HX, HS, or HZ**



Personal Tower

C24PTBBF	24 x 24 x 72	100	240	29.75	\$2091	N/A
C20PTBBF	20 x 24 x 72	100	216	25	\$2091	N/A

Includes 7" wardrobe section with a hanging rod; storage section with one adjustable shelf; and file section with **box-box-file drawers**. Locks are keyed alike. Upper lock secures wardrobe and storage section. Lower lock secures all drawers.

- **Please specify handle style when ordering - HU, HV, HW, HX, HS, or HZ**

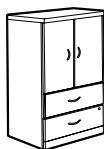

Vertical Storage/Lateral File Cabinet*

C3672VSL	20 x 36 x 72	100	301	37	\$1987	N/A
----------	--------------	-----	-----	----	---------------	-----

Contains storage area with one adjustable shelf behind a self-closing hinged door, plus two full suspension file drawers. Lateral file drawers lock.

- File drawer construction is for accommodating hanging files NOT for stacking materials on the drawer bottom.
- **Please specify handle style when ordering - HU, HV, HW, HX, HS, or HZ**

Required Specifications

- Top finish
- Base finish
- Handles (not credenza top & back or full leg)
- Edge detail*

Optional Specifications

- Key # (not credenza top & back or full leg)
- HP laminate (credenza back)

ACCESSORY PIECES



Storage Wardrobe Cabinet

MODEL#	DIMENSIONS D x W x H	FREIGHT CLASS	WT/LBS.	CUBIC FT.	LIST PRICE	HP ADD
C2436DI	24 x 36 x 72	125	298	43.25	\$2232	N/A
C3672DI	20 x 36 x 72	100	176	18.37	\$2113	N/A

Includes 16" hanging rod on one side and four adjustable shelves on the other. Lock. Shipped RTA (ready to assemble).

• **Please specify handle style when ordering - HU, HV, HW, HX, HS, or HZ**

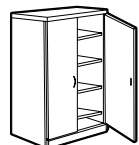

Storage Cabinet

C2436SH	24 x 36 x 72	125	320	43.25	\$1971	N/A
C3672SH	20 x 36 x 72	100	295	36.75	\$1875	N/A

Includes four adjustable shelves. Lock. Shipped RTA (ready to assemble).

• **Please specify handle style when ordering - HU, HV, HW, HX, HS, or HZ**

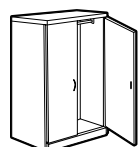

Wardrobe Cabinet

C2436ROD	24 x 36 x 72	150	244	43.25	\$2131	N/A
C3672ROD	20 x 36 x 72	125	227	37	\$1965	N/A

Includes full width hanging rod. Lock. Shipped RTA (ready to assemble).

• **Please specify handle style when ordering - HU, HV, HW, HX, HS, or HZ**

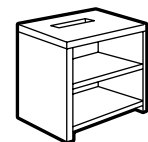

Printer Table

C2430PT	24 x 30 x 29.5	65	117	4.20	\$772	\$124
---------	----------------	----	-----	------	--------------	--------------

Includes two fixed shelves, cut-back top shelf allows paper to fall onto lower shelf. Shipped RTA (ready to assemble).

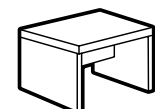

Magazine Table

C2248MT	22 x 48 x 18.5	70	75	4.25	\$480	\$176
C2222MT	22 x 22 x 18.5	70	47	3	\$376	\$93

Shipped RTA (ready to assemble).

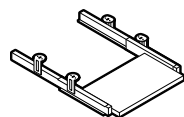

Pull-Out Keyboard

APOKL28	17 x 28 x 3.5	85	13	.90	\$245	N/A
APOKL22	17 x 22 x 3.5	85	12	.90	\$221	N/A

Constructed of thermofused laminate. **APOKL28** will accommodate keyboard and mousepad. **APOKL28** will only fit on a single pedestal desk, freestanding table, or **A42205C**. Please specify color from available finishes listed on pg. 48.

• **APOKL28** will not fit extended corners or **A42245C**, **A36205C** 5-sided corners.

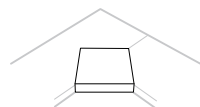

Computer Corner Plate

CCKS	18 x 18 x 11.12	70	6	.31	\$120	N/A
------	-----------------	----	---	-----	--------------	-----

Connects to two Correlation worksurfaces forming a 90° corner unit into a 45° keyboard support corner surface. Finished in Black epoxy coating. Shipped one per carton.

Required Specifications

Top finish
Base finish
Handles (not APOKL2x or CCKS)
Edge detail (not APOKL2x or CCKS)

Optional Specifications

Key #*
HP laminate (only tables)

BOOKCASES

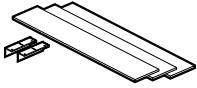

Counter Weight Kit

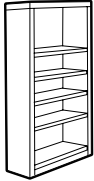

Bookcase - 72" High

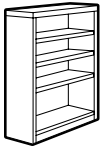

Bookcase - 65½" High

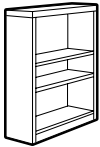

Bookcase - 48½" High

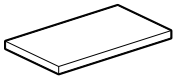

Bookcase Shelf

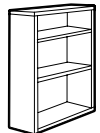

Table Top Bookcase

MODEL#	DIMENSIONS	FREIGHT CLASS	WT/LBS.	CUBIC FT.	LIST PRICE	HP ADD
--------	------------	---------------	---------	-----------	------------	--------

	D x W x H					
LFCWKIT36	6 x 33 x 1	60	40	.25	\$533	N/A

Three metal plates. Plates mount to the underside of any 36" wide Lateral File or Mixed Storage/Drawer cabinet. Includes mounting hardware. Must be ordered separately. Field installed.

- To comply with ANSI/BIFMA stability tests, the Lateral File Counter Weight Kit MUST be used with the appropriate Lateral Files and Mixed Storage Cabinets.

CBC72	12 x 36 x 72.5	125	176	23	\$921	N/A
-------	----------------	-----	-----	----	--------------	-----

One fixed heavy duty shelf and **three adjustable shelves**. Shipped fully assembled.

CBC65	12 x 36 x 65.5	125	156	21	\$860	N/A
-------	----------------	-----	-----	----	--------------	-----

One fixed heavy duty shelf and **two adjustable shelves**. Shipped fully assembled.

CBC48	12 x 36 x 48.5	125	122	15.75	\$704	N/A
-------	----------------	-----	-----	-------	--------------	-----

Two adjustable shelves. Shipped fully assembled.

CBCSHELF	11 x 34 x 1	100	13	1.60	\$161	N/A
----------	-------------	-----	----	------	--------------	-----

Extra shelf for bookcases. 1" thick.

C3643TBC	15 x 36 x 43	125	114	17	\$634	N/A
----------	--------------	-----	-----	----	--------------	-----

To be placed on top of 36" w lateral file or storage cabinet. Two adjustable shelves.

Required Specifications

Top finish
Base finish
Edge detail

BOOKCASES

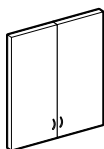

Bookcase Doors

MODEL# DIMENSIONS FREIGHT CLASS WT/LBS. CUBIC FT. LIST PRICE HP ADD

MODEL#	DIMENSIONS	FREIGHT CLASS	WT/LBS.	CUBIC FT.	LIST PRICE	HP ADD
CDOOR3643	.69 x 36 x 43	125	33	4.50	\$311	N/A

Set of doors for **C3643TBC** Table Top Bookcase

- Please specify handle style when ordering - HU, HV, HW, HX, HS, or HZ
- Locks available. ADD \$95.00 each lock.

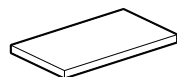

Bookcase Shelf

ATBC36SH	13.25 x 34 x 1	100	16	1.70	\$153	N/A
----------	----------------	-----	----	------	--------------	-----

Extra shelf for TABLE TOP bookcases. 1" thick.

END SHELVES

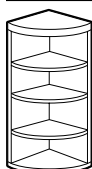

End Shelf - 72" High

C2472ESHL	24 x 24 x 72	70	157	7.25	\$935	N/A
C2072ESHL	20 x 20 x 72	70	130	7.25	\$854	N/A
C2472ESHR	24 x 24 x 72	70	157	7.25	\$935	N/A
C2072ESHR	20 x 20 x 72	70	130	7.25	\$854	N/A

For use at end of **wardrobe/storage, vertical storage cabinets, and personal towers**. Four fixed shelves. Shipped RTA (ready to assemble). **Specify left or right.**

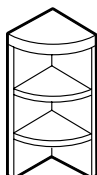

End Shelf - 42½" High

C1542ESHL	15 x 15 x 42.5	65	50	2.20	\$429	N/A
C1542ESHR	15 x 15 x 42.5	65	50	2.20	\$429	N/A

For use at end of **hutches**. Two fixed shelves. To be used on top of **C3029ESH, C2429ESH or C2029ESH**. Shipped RTA (ready to assemble). **Specify left or right.**

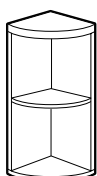

End Shelf - 29½" High

C3029ESHL	30 x 30 x 29.5	70	114	5.25	\$704	\$195
C2429ESHL	24 x 24 x 29.5	70	83	4.25	\$570	\$98
C2029ESHL	20 x 20 x 29.5	70	64	3.75	\$474	\$83
C3029ESHR	30 x 30 x 29.5	70	114	5.25	\$704	\$195
C2429ESHR	24 x 24 x 29.5	70	83	4.25	\$570	\$98
C2029ESHR	20 x 20 x 29.5	70	64	3.75	\$474	\$83

For use at end of **worksurfaces**. Two fixed shelves. Shipped RTA (ready to assemble). **Specify left or right.**

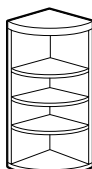

End Shelf - 50" High

C2049ESHL	20 x 20 x 49.5	65	91	3.80	\$718	N/A
C2049ESHR	20 x 20 x 49.5	65	91	3.80	\$718	N/A

For use at end of **C2036S4 4-high lateral file**. Four fixed shelves. Shipped RTA (ready to assemble). **Specify left or right.**

Required Specifications

Top finish
Base finish
Handles (only CDOOR3643)
Edge detail*

Optional Specifications

Key # (only CDOOR3643)
Locks (only CDOOR3643)

PEDESTALS

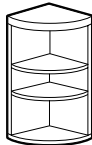

End Shelf - 38 1/4" High*



Freestanding Pedestal**

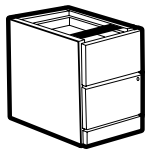

Freestanding Pedestal**

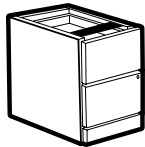

Hanging Pedestal**



Mobile Pedestal**

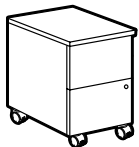

Mobile Pedestal**

MODEL#	DIMENSIONS	FREIGHT CLASS	WT./LBS.	CUBIC FT.	LIST PRICE	HP ADD
--------	------------	---------------	----------	-----------	------------	--------

D x W x H

C2038ESHL	38 x 20 x 38.25	65	77.39	2.95	\$540	N/A
C2038ESHR	38 x 20 x 38.25	65	77.39	2.95	\$540	N/A

For use at end of **C2036S3 3-high lateral file**. Three fixed shelves. Shipped RTA (ready to assemble). **Specify left or right.**

AFPBBF19	19 x 16 x 28	100	68	7.25	\$787	N/A
AFPBBF22	22 x 16 x 28	100	72	8.25	\$806	N/A
AFPBBF28	28 x 16 x 28	100	88	10.25	\$838	N/A

For use under a freestanding worksurface (20", 24" or 30"); attaches to worksurface top. **No top and unfinished back.** Two box and one file drawer. One pencil tray. File drawer and lower box drawer are locking.

- *Cannot be used with **C2466** extended corners.*
- *Available with factory installed handle option, see page 47 for details. Add \$35.00*
- *When used with Connectable Tables (e.g. C2472T) bottom rear of pedestal will show because of the modesty on table units*

AFPPF19	19 x 16 x 28	100	67	7.25	\$852	N/A
AFPPF22	22 x 16 x 28	100	75	8.25	\$864	N/A
AFPPF28	28 x 16 x 28	100	89	10.25	\$911	N/A

For use under a freestanding worksurface (20", 24" or 30"); attaches to worksurface top. **No top and unfinished back.** Two file drawers. Locking.

- *Cannot be used with **C2466** extended corners.*
- *Available with factory installed handle option, see page 47 for details. Add \$35.00*
- *When used with Connectable Tables (e.g. C2472T) bottom rear of pedestal will show because of the modesty on table units*

AHPBF18	18 x 16 x 18	92.5	48	4.50	\$549	N/A
---------	--------------	------	----	------	--------------	-----

For use under a freestanding worksurface (20", 24" or 30"); attaches to worksurface top. **No top and unfinished back.** One box and one file drawer. One pencil tray. Locking. 18" high.

- *Cannot be used with **C2466** extended corners.*
- *Available with factory installed handle option, see page 47 for details. Add \$35.00*
- *When used with Connectable Tables (e.g. C2472T) bottom rear of pedestal will show because of the modesty on table units*

AMPBBF19	19 x 16 x 28	85	96	6.50	\$822	\$156
AMPBBF22	23 x 16 x 28	92.5	92	7.75	\$831	\$154
AMPBBF28	29 x 16 x 28	92.5	105	9.50	\$864	\$156

Pedestal on casters. Front casters lock. Fits under worksurfaces and is easily moved. Two box and one file drawer. One pencil tray. File drawer and lower box drawer are locking.

- *Cannot be used with **C2466** extended corners.*
- *Available with factory installed handle option, see page 47 for details. Add \$35.00*

AMPFF19	19 x 16 x 28	85	97	6.50	\$885	\$156
AMPFF22	23 x 16 x 28	85	95	7.75	\$898	\$156
AMPFF28	29 x 16 x 28	92.5	106	9.50	\$944	\$156

Pedestal on casters. Front casters lock. Fits under worksurfaces and is easily moved. Two file drawers. Locking.

- *Cannot be used with **C2466** extended corners.*
- *Available with factory installed handle option, see page 47 for details. Add \$35.00*

Required Specifications

Top finish
Base finish (only end shelves)
Edge detail*

Optional Specifications

Key #**
HP laminate (mobile pedestals)
Handle**

BOARDROOM TABLES

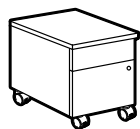

Mobile Pedestal

MODEL#	DIMENSIONS	FREIGHT CLASS	WT/LBS.	CUBIC FT.	LIST PRICE	HP ADD
--------	------------	---------------	---------	-----------	------------	--------

D x W x H						
AMPBF19	19 x 16 x 22	85	77	5.25	\$723	\$156
AMPBF22	23 x 16 x 22	85	73	6	\$740	\$156
AMPBF28	29 x 16 x 22	92.5	83	7.50	\$760	\$156

Pedestal on casters. Front casters lock. Fits under worksurfaces and is easily moved. One box and one file drawer. One pencil tray. Locking. 22" high.

- Available with factory installed handle option, see page 47 for details. Add \$35.00

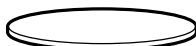

Boardroom Table - Round Top

A48R	48 x 48 x 1.5	85	95	7.50	\$467	\$362
A42R	42 x 42 x 1.5	85	73	5.75	\$446	\$362
A36R	36 x 36 x 1.5	92.5	54	4.90	\$324	\$207

A48R may be used with four monoposts. **A36R** and **A42R** may be used only with cross base or drum base. or **FL** edge. Please specify.

- Also available with bicut edge (**CR**) at no upcharge. Please specify.
- **A48R** uses monoposts only



Boardroom Table - Rectangular Top

A48120RE	48 x 120 x 1.5	70	274	13	\$1003	\$826
A4896RE	48 x 96 x 1.5	65	314	11.50	\$764	\$671
A3672RE	36 x 72 x 1.5	65	175	7	\$563	\$387

For use with two drum bases, two "V" bases, one panel base OR four monoposts. Predrilled for "V" base and panel base.

Top comes in one piece, except for A48120RE (two pieces) Available with **3M** or **FL** edge. Please specify.

- Also available with bicut edge (**CR**) at no upcharge. Please specify.
- **A48120RE** uses three drum bases, three "V" bases, one double panel base OR six monoposts.



Boardroom Table - Boat Shape Top

A48144B	48 x 144 x 1.5	60	237	7.50	\$1163	\$980
A48120B	48 x 120 x 1.5	60	198	6.30	\$1003	\$826
A4896B	48 x 96 x 1.5	70	193	9.80	\$787	\$671

For use with three drum bases, three "V" bases, one double panel base OR six monoposts. Predrilled for "V" base and panel base. **Top comes in two pieces, except for A4896B.** Available with **3M** or **FL** edge. Please specify.

- Also available with bicut edge (**CR**) at no upcharge. Please specify.
- **A4896B** uses two drum bases, two "V" bases, one panel base OR four monoposts.



Boardroom Table - Racetrack Top

A48144RT	48 x 144 x 1.5	60	251	7.50	\$1163	\$980
A48120RT	48 x 120 x 1.5	60	204	6.30	\$1003	\$826
A4896RT	48 x 96 x 1.5	70	200	9.80	\$787	\$671
A3672RT	36 x 72 x 1.5	70	112	5.80	\$605	\$387

For use with three drum bases, three "V" bases, one double panel base OR six monoposts. Predrilled for "V" base and panel base. **Top comes in two pieces except for A4896RT and A3672RT.** Available with **3M** or **FL** edge. Please specify.

- Also available with bicut edge (**CR**) at no upcharge. Please specify.
- **NOTE:** 48" x 120" and 48" x 144" woodgrain finish Adaptabilities tables will not have a perfect match of grain at the center where the two halves meet.
- **A4896RT** and **A3672RT** use two drum bases, two "V" bases, one panel base OR four monoposts.

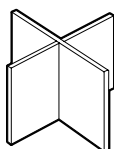

Cross Base

A2727XB	27 x 27 x 28	70	63	3.60	\$300	N/A
---------	--------------	----	----	------	--------------	-----

Use as the base for **36"** or **42"** round tops (model **A36R** or **A42R**). Shipped RTA (ready to assemble).

Required Specifications

Top finish
Edge detail (not base)

Optional Specifications

HP laminate (not base)

BOARDROOM TABLES

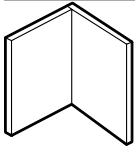

"V" Base

MODEL#	DIMENSIONS D x W x H	FREIGHT CLASS	WT./LBS.	CUBIC FT.	LIST PRICE	HP ADD
A1616V	16 x 16 x 28	60	39	1.10	\$255	N/A
A1616V2	16 x 16 x 28	60	74	1.10	\$504	N/A

Use as the base for **rectangular, boat shaped or racetrack tops**. Shipped RTA (ready to assemble).
 • **A1616V2** is shipped 2 bases per carton.

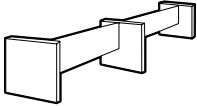

Panel Base

A2488PB	24 x 88 x 28	70	119	6	\$803	N/A
A2445PB	24 x 45 x 28	70	76	4.30	\$524	N/A

Use as the base for **rectangular, boat shaped or racetrack tops**. Shipped RTA (ready to assemble).
 • Use **A2488PB** for 120 - 144" wide tops.
 • Use **A2445PB** for 72 - 96" wide tops.

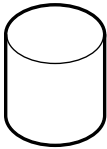

Drum Base

A18Z	18 x 18 x 28	250	29	7.50	\$563	N/A
------	--------------	-----	----	------	--------------	-----

Use as the base for **36" or 42" round tops (model A36R or A42R)** and **72", 96", 120" or 144" wide tops**. Available in **Black finish only**.
 • All Drum Bases require approx. 125 lb. of sand in each base for adequate stability. Sand not included.

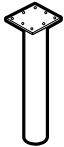

Mono Post

A5L	5 x 5 x 28	100	13	1.50	\$245	N/A
-----	------------	-----	----	------	--------------	-----

Use as the base for **48" (model A48R) round tops** and **72", 96", 120" or 144" wide tops**.
 • Post is shipped in separate carton. Standard in Black; Silver is available at no charge, please specify **SI**.

BOARDROOM ACCESSORIES



Serving Cart*

C2036SK	20 x 36 x 36.5	100	189	19	\$1830	\$124
---------	----------------	-----	-----	----	---------------	--------------

Includes **two** side opening, self-closing hinged doors, **two box drawers**, one slide-out tray and storage shelf. On casters.
 • Also available with bicut edge (**CR**) at no upcharge. Please specify.
 • Please specify handle style when ordering - **HU, HV, HW, HX, HS, or HZ**

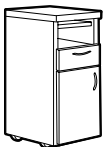

Serving Cart*

C2020SK	20 x 20 x 36.5	92.5	120	11.25	\$1160	\$83
---------	----------------	------	-----	-------	---------------	-------------

Includes **one** side opening, self-closing hinged door, **one box drawer**, one slide-out tray and storage shelf. On casters.
 • Also available with bicut edge (**CR**) at no upcharge. Please specify.
 • Please specify handle style when ordering - **HU, HV, HW, HX, HS, or HZ**

Required Specifications

Top finish
 Base finish
 Handles*
 Edge detail*

Optional Specifications

Key #*
 HP laminate*

BOARDROOM ACCESSORIES

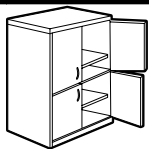

Audio/Visual Cabinet*

MODEL#	DIMENSIONS D x W x H	FREIGHT CLASS	WT/LBS.	CUBIC FT.	LIST PRICE	HP ADD
C3672AV	24 x 36 x 72	125	314	47.60	\$2131	N/A

Includes **four** side opening doors covering two adjustable and two fixed shelves. Wire access through one grommet on back panel. Holds up to 27"H TV monitor. Shipped RTA (ready to assemble).

- **Please specify handle style when ordering - HU, HV, HW, HX, HS, or HZ**

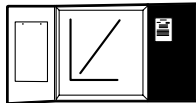

Visual Board*

CVB4849	44 x 48 x 49	70	141	9.25	\$1277	N/A
---------	--------------	----	-----	------	---------------	-----

Includes white board and two side opening doors containing cork board on right door and 50-sheet paper writing pad on left door. Marker board can be used for projection. Set of 4 dry markers and eraser included.

- **NOTE:** Care should be taken to mount the units. Units should be mounted to wall studs using correct fasteners. Failure to do so may result in collapse of the unit and subsequent personal injury. **Mounting hardware not included.** Mounting hardware used should be based on wall material. Consult an installation professional for proper wall mounting.

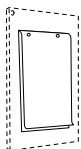

Flip Chart Pad

FC	30 x 20 x 30	92.5	20	2	\$277	N/A
----	--------------	------	----	---	--------------	-----

Additional flip chart paper for double door visual boards. 50 sheets per pad. Five pads per package. Price is per package.



Lectern*

C1844LC	18 x 24 x 44.5	70	98	4.70	\$653	\$83
---------	----------------	----	----	------	--------------	-------------

Features angled stand, storage shelf and casters. Shipped RTA (ready to assemble).

Required Specifications

Top finish*
Base finish*

Optional Specifications

HP laminate (Lectern)



The **Genoa**® series combines the value of laminate furniture with the contemporary styling of top over end panel design. This versatile offering of components and wide selection of laminate finish options is the perfect complement to any office environment.

For added security of confidential material, all desks and credenzas are equipped with one locking pedestal. Genoa's kneespace credenza easily accommodates a computer, books, binders and files to maximize space.

Genoa features quality construction with the added strength of dovetailed box and file drawers. Fully progressive ball bearing suspensions ensure years of smooth, trouble-free drawer service.

Genoa's classic styling and simplicity integrate easily with existing furnishings and any interior decor. For new offices or current office expansions, Genoa is clearly the affordable and practical choice.

Features and Benefits

- 45lb. density particle board substructure with high performance thermally fused laminate
- Available bow front desk provides extra legroom and work area for visitors
- ¾ modesty panel is standard
- Most components shipped fully assembled, 1 per carton
- 75lb. box - 150 lb. file drawer weight capacity with full height sides, plus pencil tray included in box drawer
- Box drawers mounted on ¾ extension steel ball bearings
- All drawers feature French dovetail joint in front and lapjoint in back
- Drawers open with side pull
- Compatible with **Divide, e0+ and GPS II** panel systems for increased privacy and storage requirements

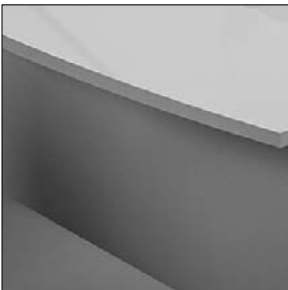

Bow front available on 36" x 72" desks



Contemporary top-over-end panel design



Drawer fronts are edge banded on all sides

GENERAL INFORMATION

- Constructed of 45 lb. density particle board with high performance thermally fused laminate
- Genoa components are compatible with **GPS II, e0+ and Divide** partitioning panels.
- Large offering of extended corners, full to floor pedestals, islands and storage options
- Double wall pedestal housing
- Genoa desk and storage products have been tested and comply with all BIFMA mechanical tests.
- GREENGUARD INDOOR AIR QUALITY CERTIFICATION - Global laminate and seating products are in compliance with stringent emission guidelines set out by the Greenguard Environmental Institute under the standards for low emitting products and materials. www.greenguard.org.
- **Level 3 Certified**

CONSTRUCTION

- Constructed of 45 lb. density particleboard with high performance thermally fused laminate
- Double wall pedestal housing
- Panel end style with top over side panel design
- 1" adjustable leveling glides standard on all units
- Standard with locks

MODESTY PANELS

- Recessed ¾ height modesty panel is standard. Full modesty panel available. **Add \$51.**
- All full to floor units, bridges and returns are standard with a full modesty panel

STORAGE

- All lateral file drawer fronts feature the woodgrain running in a horizontal direction
- 75 lb box - 150 lb. file drawer weight capacity with full height sides with pencil tray included in box drawer
- All drawers feature French dovetail joint in front and lapjoint in back

FINISHES

ACJ	Absolute Acajou	ASN	Asian Night
AWC	Avant Cherry	AWH	Avant Honey
BLK	Black	CSJ	Constellation Java
DES	Dark Espresso	GRY	Grey
HGT	Hayden Grey	QTM	Quartered Mahogany
SKC	Shaker Cherry	TFW	Tiger Fruitwood
TMA	Tiger Mahogany	TMP	Tiger Maple
TWL	Tiger Walnut	WHT	White
WHC	White Chocolate	WGY	Willow Grey
WCR	Winter Cherry		

GROMMETS

- Grommets may be ordered on Genoa hutch back panel
- Additional grommets available in standard worksurface locations (left, center or right). Order as: **AG1, AG2 or AG3. Add \$65**
- Grommet hole dimensions are 3 ¼" wide x 1 7/8" deep

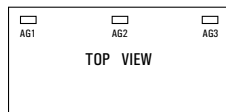

- Actual grommet locations on the worksurface are depicted in the example drawings shown below. Dimensions shown are actual measurements (in inches).

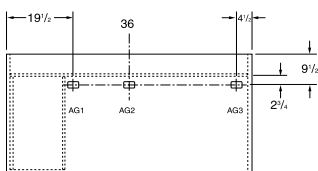

36 x 72 single pedestal left desks (3672SPL)

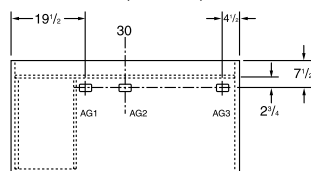

30 x 60 single pedestal left desks (3060SPL)

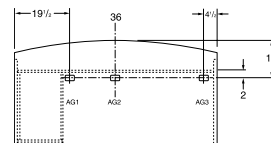

36 x 72 single pedestal left bow top desks (3672SLB)

- Grommets may be placed at non-standard locations. Order as: **AGS - Add \$65.** A drawing must be supplied with vertical and horizontal dimensions to the center of the cut-out (as in drawing above). Please refer to CUSTOM GROMMET LOCATION FORM in the back reference section.
- Components that come standard with grommet may be ordered without a grommet. **Add \$35.**
- Grommets are available on modesty panels of **5-sided corners** 6 ½" in where the two modesty panels meet at a 90° angle. Please specify **FOGMPR** for right grommet placement and **FOGMPL** for left grommet (placement is as shown on diagrams below). Cost is **\$65.**

*Modesty Panels are 1" off of ground

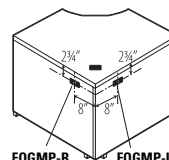

5-Sided Corner Unit

POWER BLOCK

- A Power Block (model **PMSBDM**) may be ordered on all worksurfaces
- A Power Block is a rectangular worksurface power/data module with one electrical duplex receptacle and two data (RJ45) receptacles. 9 foot black cord included. Power Block dimensions are 3 ½" deep x 6 ½" wide x 2 ¾" high.
- To purchase a Power Block, you must specify both the Power Block cut-out location and the Power Block model #. Order Power Block as **PMSBDM, Add \$238.** Power Blocks are available in standard worksurface locations (left, center or right). Order as **E1, E2 or E3. Add \$65.**

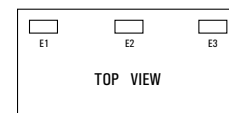

Power Block **PMSBDM. Add \$238** Specify location **E1, E2 or E3. Add \$65**

DOUBLE PEDESTAL DESKS

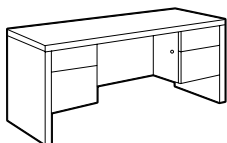

Double Pedestal Desk

MODEL#	DIMENSIONS D x W x H	FREIGHT CLASS	WT/LBS.	CUBIC FT.	LIST PRICE
G3672DP	36 x 72 x 29	150	286	50.50	\$973
G3072DP	30 x 72 x 29	150	245	43.75	\$948
G3066DP	29.69 x 66 x 29	150	235	39.25	\$921
G3060DP	29.69 x 60 x 29	125	226	35.50	\$772

Standard with box/file pedestals on both sides. Pedestals lock. One pencil tray.

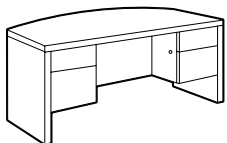

Double Pedestal Bow Top Desk

G3672DPB	32-36 x 72 x 29	150	256	50.50	\$1196
----------	-----------------	-----	-----	-------	---------------

Standard with box/file pedestals on both sides and bow top. Pedestals lock. One pencil tray.

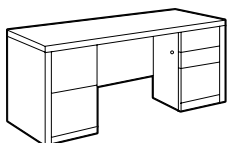

Full to Floor Double Pedestal Desk

G3072D4	29.69 x 60 x 29	125	277	43.75	\$1243
---------	-----------------	-----	-----	-------	---------------

Standard with full to floor box/file on right pedestal and file/file on left pedestal. Pedestals lock. One pencil tray.

SINGLE PEDESTAL DESKS

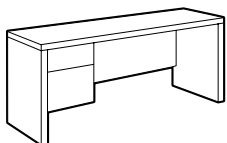

Single Pedestal Desk - LEFT

G3672SPL	36 x 72 x 29	150	235	50.50	\$885
G3072SPL	30 x 72 x 29	150	192	43.75	\$839
G3066SPL	29.69 x 66 x 29	150	192	39.25	\$825
G3060SPL	29.69 x 60 x 29	150	183	35.50	\$682
G3048SPL	29.69 x 48 x 29	150	166	28.75	\$682
G2445SPL	24 x 45 x 29	150	137	23.50	\$533

Standard with box/file pedestal. Pedestal locks. One pencil tray. Pedestal is on the **left**.

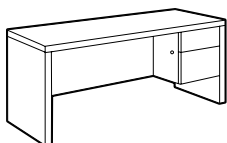

Single Pedestal Desk - RIGHT

G3672SPR	36 x 72 x 29	150	235	50.50	\$885
G3072SPR	30 x 72 x 29	150	192	43.75	\$839
G3066SPR	29.69 x 66 x 29	150	192	39.25	\$825
G3060SPR	29.69 x 60 x 29	150	183	35.50	\$682
G3048SPR	29.69 x 48 x 29	150	166	28.75	\$682
G2445SPR	24 x 45 x 29	150	137	23.50	\$533

Standard with box/file pedestal. Pedestal locks. One pencil tray. Pedestal is on the **right**.

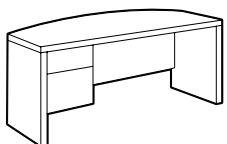

Single Pedestal Bow Top Desk - LEFT

G3672SLB	32-36 x 72 x 29	150	270	50	\$1094
----------	-----------------	-----	-----	----	---------------

Standard with box/file pedestal on **left** and bow top. Pedestal locks. One pencil tray.

Required Specifications

Finish

Optional Specifications

Full modesty
Grommet
Key #

Accessories

Power block
Keyboard tray
Pencil tray

SINGLE PEDESTAL DESKS

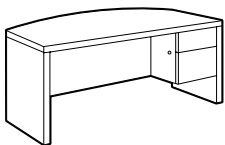

Single Pedestal Bow Top Desk - RIGHT

MODEL# DIMENSIONS FREIGHT CLASS WT/LBS. CUBIC FT. LIST PRICE

D x W x H

G3672SRB	36 x 72 x 29	150	270	50	\$1094
----------	--------------	-----	-----	----	---------------

Standard with box/file pedestal on **right** and bow top. Pedestal locks. One pencil tray.

RETURNS

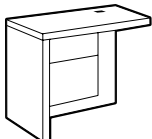

Typing Return - LEFT

G2448SDL	24 x 48 x 26	150	137	23.50	\$549
G2040SDL	20 x 40 x 26	125	111	17.50	\$533

Standard with box/file pedestal and lower **26" height**. Pedestal locks. Grommet in worksurface. Pedestal is on the **left**.

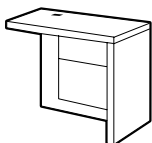

Typing Return - RIGHT

G2448SDR	24 x 48 x 26	150	137	23.50	\$549
G2040SDR	20 x 40 x 26	125	111	17.50	\$533

Standard with box/file pedestal and lower **26" height**. Pedestal locks. Grommet in worksurface. Pedestal is on the **right**.

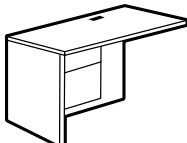

Flush Return - LEFT

G2454FL	24 x 54 x 29	150	127	27	\$667
G2448FL	24 x 48 x 29	125	142	23.50	\$592
G2442FL	24 x 42 x 29	150	111	21.50	\$570
G2054FL	20 x 54 x 29	150	114	23	\$667
G2048FL	20 x 48 x 29	150	107	20.50	\$592
G2042FL	20 x 42 x 29	150	100	18	\$570
G2040FL	20 x 40 x 29	125	115	17.50	\$563
G2036FL	20 x 36 x 29	125	93	15.50	\$563

Standard with box/file drawer pedestal. Pedestal locks. Grommet in worksurface. Pedestal is on the **left**.

- For 24" deep worksurfaces, order **G24__FL**. For 20" deep worksurfaces, order **G20__FL**.
- Keyboard and pencil trays for use on units 42" and above

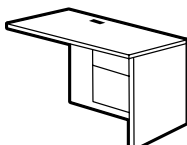

Flush Return - RIGHT

G2454FR	24 x 54 x 29	150	127	27	\$667
G2448FR	24 x 48 x 29	125	142	23.50	\$592
G2442FR	24 x 42 x 29	150	111	21.50	\$570
G2054FR	20 x 54 x 29	150	114	23	\$667
G2048FR	20 x 48 x 29	150	107	20.50	\$592
G2042FR	20 x 42 x 29	150	100	18	\$570
G2040FR	20 x 40 x 29	125	115	17.50	\$563
G2036FR	20 x 36 x 29	125	93	15.50	\$563

Standard with box/file drawer pedestal. Pedestal locks. Grommet in worksurface. Pedestal is on the **right**.

- For 24" deep worksurfaces, order **G24__FR**. For 20" deep worksurfaces, order **G20__FR**.
- Keyboard and pencil trays for use on units 42" and above

Required Specifications

Finish

Optional Specifications

Key #

Accessories

- Power block
- Keyboard tray
- Pencil tray

RETURNS

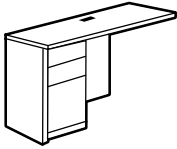

Full to Floor Flush Return - LEFT

MODEL#	DIMENSIONS D x W x H	FREIGHT CLASS	WT./LBS.	CUBIC FT.	LIST PRICE
G2448BL4	24 x 48 x 29	150	136	25	\$860
G2442BL4	24 x 42 x 29	150	128	21.50	\$848
G2436BL4	24 x 36 x 29	125	120	18	\$831
G2048BL4	20 x 48 x 29	150	121	20.50	\$838
G2042BL4	20 x 42 x 29	125	114	18	\$816
G2036BL4	20 x 36 x 29	125	108	15.50	\$802

Standard with box/box/file drawer pedestal. Lower box drawer and file drawer lock. Grommet in worksurface. Pedestal is on the **left**.

- For 24" deep worksurfaces, order **G24__BL4**. For 20" deep worksurfaces, order **G20__BL4**.
- Keyboard and pencil trays for use on units 42" and above

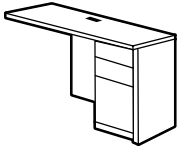

Full to Floor Flush Return - RIGHT

G2448BR4	24 x 48 x 29	150	136	25	\$860
G2442BR4	24 x 42 x 29	150	128	21.50	\$848
G2436BR4	24 x 36 x 29	125	120	18	\$831
G2048BR4	20 x 48 x 29	150	121	20.50	\$838
G2042BR4	20 x 42 x 29	125	114	18	\$816
G2036BR4	20 x 36 x 29	125	108	15.50	\$802

Standard with box/box/file drawer pedestal. Lower box drawer and file drawer lock. Grommet in worksurface. Pedestal is on the **right**.

- For 24" deep worksurfaces, order **G24__BR4**. For 20" deep worksurfaces, order **G20__BR4**.
- Keyboard and pencil trays for use on units 42" and above

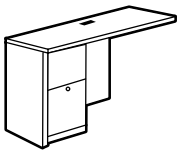

Full to Floor Flush Return - LEFT

G2448L4	24 x 48 x 29	150	132	25	\$885
G2442L4	24 x 42 x 29	150	124	21.50	\$868
G2436L4	24 x 36 x 29	125	116	18	\$854
G2048L4	20 x 48 x 29	150	118	20.50	\$860
G2042L4	20 x 42 x 29	125	111	18	\$838
G2036L4	20 x 36 x 29	125	104	15.50	\$825

Standard with file/file drawer pedestal. Pedestal locks. Grommet in worksurface. Pedestal is on the **left**.

- For 24" deep worksurfaces, order **G24__L4**. For 20" deep worksurfaces, order **G20__L4**.
- Keyboard and pencil trays for use on units 42" and above

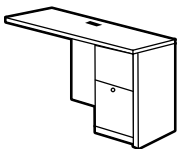

Full to Floor Flush Return - RIGHT

G2448R4	24 x 48 x 29	150	132	25	\$885
G2442R4	24 x 42 x 29	150	124	21.50	\$868
G2436R4	24 x 36 x 29	125	116	18	\$854
G2048R4	20 x 48 x 29	150	118	20.50	\$860
G2042R4	20 x 42 x 29	125	111	18	\$838
G2036R4	20 x 36 x 29	125	104	15.50	\$825

Standard with file/file drawer pedestal. Pedestal locks. Grommet in worksurface. Pedestal is on the **right**.

- For 24" deep worksurfaces, order **G24__R4**. For 20" deep worksurfaces, order **G20__R4**.
- Keyboard and pencil trays for use on units 42" and above

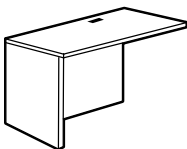

Flush Return - LEFT

G2454EL	24 x 54 x 29	70	87	5.25	\$549
G2448EL	24 x 48 x 29	70	96	4.50	\$474
G2442EL	24 x 42 x 29	70	71	3.80	\$474
G2054EL	20 x 54 x 29	85	78	5.25	\$520
G2048EL	20 x 48 x 29	70	70	4.20	\$489
G2042EL	20 x 42 x 29	70	56	3.30	\$474
G2040EL	20 x 40 x 29	70	78	4.50	\$458
G2036EL	20 x 36 x 29	70	56	3.30	\$458

Return has no pedestal. Grommet in worksurface. Shipped RTA (ready to assemble).

- For 24" deep worksurfaces, order **G24__EL**. For 20" deep worksurfaces, order **G20__EL**.

Required Specifications

Finish

Optional Specifications

Additional grommet
Key #

Accessories

Power block
Keyboard tray
Pencil tray

RETURNS

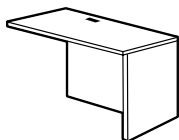

Flush Return - RIGHT

MODEL# DIMENSIONS FREIGHT CLASS WT/LBS. CUBIC FT. LIST PRICE

D x W x H

G2454ER	24 x 54 x 29	70	87	5.25	\$549
G2448ER	24 x 48 x 29	70	96	4.50	\$474
G2442ER	24 x 42 x 29	70	71	3.80	\$474
G2054ER	20 x 54 x 29	85	78	5.25	\$520
G2048ER	20 x 48 x 29	70	70	4.20	\$489
G2042ER	20 x 42 x 29	70	63	3.80	\$474
G2040ER	20 x 40 x 29	70	78	4.50	\$458
G2036ER	20 x 36 x 29	70	56	3.30	\$458

Return has no pedestal. Grommet in worksurface. Shipped RTA (ready to assemble).

- For 24" deep worksurfaces, order **G24__ER**. For 20" deep worksurfaces, order **G20__ER**.

FLUSH BRIDGE

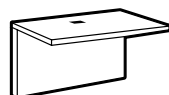

Flush Bridge

G2448FB	24 x 48 x 29	70	78	3.50	\$360
G2442FB	24 x 42 x 29	70	65	3.06	\$348
G2436FB	24 x 36 x 29	70	58	3.50	\$347
G2048FB	20 x 48 x 29	70	71	3.30	\$360
G2042FB	20 x 42 x 29	70	61	4	\$348

Top surface, back panel and hardware to connect two units. Grommet in worksurface. Shipped RTA (ready to assemble).

- **G2448/G2442** models will connect 66" and 72" units plus all D islands.
- **G2048/G2042** models will connect 60", 66" and 72" units plus all D islands and 5 sided corners.

CREDENZAS



Center Storage Credenza*

G2066C	20 x 66 x 29	100	225	27	\$1056
--------	--------------	-----	-----	----	---------------

Standard with box/file pedestals on both sides and self-closing hinged center doors covering one adjustable shelf. Right pedestal and doors lock. One pencil tray.

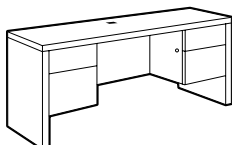

Kneespace Credenza*

G2072CK	20 x 72 x 29	125	209	29.50	\$973
G2066CK	20 x 66 x 29	125	201	27	\$921
G2060CK	20 x 60 x 29	125	193	24.50	\$854

Standard with box/file pedestals on both sides. Center is open. Pedestals lock. One pencil tray. Grommet in worksurface.

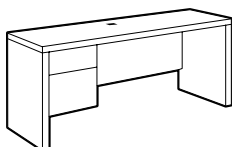

Single Pedestal Credenza - LEFT*

G2072CSL	20 x 72 x 29	150	171	29.50	\$825
G2066CSL	20 x 66 x 29	150	163	27.75	\$809
G2060CSL	20 x 60 x 29	125	155	24.50	\$712

Standard with box/file pedestal. Pedestal locks. One pencil tray. Pedestal is on the **left**. Grommet in worksurface.

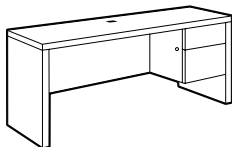

Single Pedestal Credenza - RIGHT*

G2072CSR	20 x 72 x 29	150	150	29.50	\$825
G2066CSR	20 x 66 x 29	150	150	29.40	\$809
G2060CSR	20 x 60 x 29	150	136	24.50	\$712

Standard with box/file pedestal. Pedestal locks. One pencil tray. Pedestal is on the **right**. Grommet in worksurface.

Required Specifications

Finish

Optional Specifications

Full modesty*
Grommet
Key #

Accessories

Power block
Keyboard tray
Pencil tray

5-SIDE CORNERS

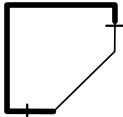
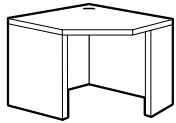

5-Sided Corner

MODEL#	DIMENSIONS D x W x H	FREIGHT CLASS	WT/LBS.	CUBIC FT.	LIST PRICE
G42205C9	42 x 42 x 29	70	123	5.75	\$741
G36205C9	36 x 36 x 29	65	105	4.30	\$629

Connects to lateral file, storage cabinet, single pedestal credenza with half end panel, and flush bridge. Grommet in worksurface. Full and narrow end panels supplied. Can be assembled left or right. Shipped RTA (ready to assemble)

- ¾ Modesty Panel is not available

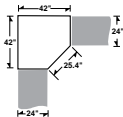
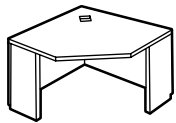

5-Sided Corner

G42245C	42 x 42 x 29	65	114	5	\$752
---------	--------------	----	-----	---	--------------

Connects to **24"** returns, bridges and other **24"** units. Grommet in worksurface. Narrow end panels on left and right. Shipped RTA (ready to assemble).

- ¾ Modesty Panel is not available

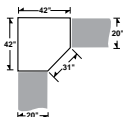
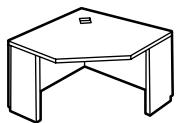

5-Sided Corner

G42205C	42 x 42 x 29	70	108	5	\$729
G36205C	36 x 36 x 29	70	92	4.75	\$645

Connects to **20"** returns, bridges and other **20"** units. Grommet in worksurface. Narrow end panels on left and right. Shipped RTA (ready to assemble).

- ¾ Modesty Panel is not available

"D" ISLANDS

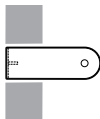
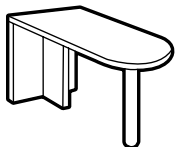

"D" Island - Full End Panel & Post

G3072FI	29.69 x 72 x 29	70	101	5	\$718
G3066FI	29.69 x 66 x 29	70	96	4.60	\$704
G3060FI	29.69 x 60 x 29	70	91	4.20	\$653

Connects to single pedestal credenza with half end panel or bridge to create a "T" grouping. **Not freestanding.** Connecting hardware for flush installation included. Shipped RTA (ready to assemble).

HUTCHES

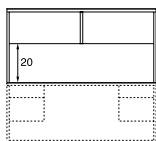
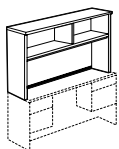

Open Hutch with Closed Back*

G72HOCB	15 x 72 x 36	70	138	7	\$825
G71HOCB	15 x 71.63 x 36	70	137	7	\$825
G69HOCB	15 x 69 x 36	70	135	7	\$825
G66HOCB	15 x 66 x 36	70	133	7	\$793
G60HOCB	15 x 60 x 36	65	123	5.25	\$712

One 1" thick fixed shelf **and fixed shelf divider**. Closed back features a flexible sweep for wire management. Available in single color only. Rectangular grommet available on back panel...**Add \$65.00** Shipped RTA (ready to assemble).

- **G71HOCB** for use when spanning 30" x 60/66" SPL/R and 20/24" x 42" FL/FR/L4/R4.
- **G69HOCB** for use when spanning 30" x 60/66" SPL/R and 20" x 42" FL/FR/L4/R4.
- Clearance from worksurface to hutch doors is 20".
- Woodgrain runs horizontal on both the upper and lower back panels.

Required Specifications
Finish

Optional Specifications
Grommet

Accessories
Power Block
Keyboard Tray
Pencil Tray
Doors*

HUTCHES

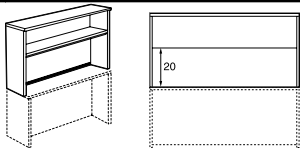

Open Hutch with Closed Back*

MODEL# DIMENSIONS FREIGHT CLASS WT/LBS. CUBIC FT. LIST PRICE

	D x W x H				
G48HOCB	15 x 48 x 36	65	100	4.20	\$570
G42HOCB	15 x 42 x 36	65	91	3.80	\$570
G40HOCB	15 x 40 x 36	65	88	3.80	\$570
G36HOCB	15 x 36 x 36	65	82	3.30	\$502

One 1" thick fixed shelf. Closed back features a flexible sweep for wire management. Available in single color only. Rectangular grommet available on back panel....**Add \$65.00** Shipped RTA (ready to assemble).

- Clearance from worksurface to hutch doors is 20".
- Woodgrain runs horizontal on both the upper and lower back panels.

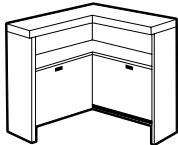

Corner Hutch with Closed Back*

G4242CH	15 x 42 x 36	70	137	6.25	\$907
G3636CH	15 x 36 x 36	65	119	4.80	\$825

One 1" thick fixed shelf. Closed back features a flexible sweep for wire management on lower right panel. Available in single color only. Rectangular grommet available on back panel....**Add \$65.00** Shipped RTA (ready to assemble).

- Woodgrain runs horizontal on both the upper and lower back panels.

PIGEON HOLE STORAGE

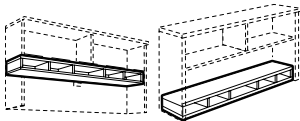

Horizontal Pigeon-Hole Storage

AHS72	11.25 x 70 x 5.62	85	41	3	\$508
AHS71	11.25 x 71 x 5.62	70	43.50	2.30	\$508
AHS66	11.25 x 64 x 5.62	85	38	2.80	\$508
AHS60	11.25 x 58 x 5.62	85	35	2.50	\$416
AHS48	11.25 x 46 x 5.62	85	28	2	\$306
AHS42	11.25 x 40 x 5.62	85	24	2	\$306
AHS36	11.25 x 34 x 5.62	92.5	22	2	\$250

For additional storage. Can be **top** or **bottom** mounted. For use inside **straight hutch** (end panels not finished). Shipped RTA (ready to assemble). **Black finish only.**

- Cannot be used on A00S and C00S Overstorage Units.

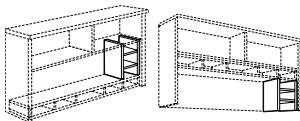

Vertical Pigeon-Hole Storage

AVS14	11.25 x 13.37 x 14.37	85	13	.90	\$317
-------	-----------------------	----	----	-----	--------------

For use in conjunction with the Horizontal Pigeon-Hole Storage. Can be used **under** or **over** horizontal unit. Shipped RTA (ready to assemble). **Black finish only.**

HUTCH DOORS

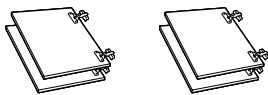

Four-Door Kit

GDOOR72	.69 x 72 x 15	85	24	1.75	\$302
GDOOR71	15.68 x 0 x 15	85	24	1.75	\$302
GDOOR69	15.68 x 0 x 15	85	23	1.75	\$302
GDOOR66	.69 x 66 x 15	85	22	1.75	\$302
GDOOR60	.69 x 60 x 15	92.5	20	1.75	\$302

For use on 72", 71", 69", 66" and 60"W straight hutches. Hinges included. Locks available, **ADD \$95** each lock. Doors for units 60" wide or more require two locks.

Required Specifications

Finish

Accessories

Doors*

HUTCH DOORS

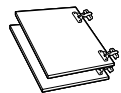

Two-Door Kit

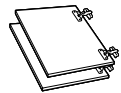

Corner Hutch Two-Door Kit

MODEL#	DIMENSIONS D x W x H	FREIGHT CLASS	WT/LBS.	CUBIC FT.	LIST PRICE
GDOOR48	.69 x 48 x 15	100	17	1.75	\$189
GDOOR42	.69 x 42 x 15	100	16	1.75	\$189
GDOOR40	.69 x 40 x 15	100	15	1.75	\$189
GDOOR36	.69 x 36 x 15	100	14	1.75	\$189

For use on 48", 42" 40" and 36"W straight hutches. Hinges included. Locks available, ADD **\$95** each lock. Doors for units 48" wide or less require one lock.

GDOOR42C	15.68 x 0 x 15	92.5	19	1.75	\$324
GDOOR36C	15.68 x 0 x 15	100	16	1.75	\$210

For use on 42" and 36"W corner hutches. Hinges included. **Locks not available on corner hutch doors.**

TACKBOARDS FOR HUTCHES

TACKBOARD Notes: Tackboards can be upholstered in all of the following fabrics:

Grade 1: Agate II, Drama, Jenny, Pebbles, Quilt, Sprinkle, Station, Urban

Grade 2: Couture, Crescent, Cumulus, Imprint, Lola, Match, Oxygen, Quantum, Renewal, Replay, Silhouette

Grade 3: Brinx, Mariposa

Grade 4: Accent

Grade 5: Meander, Tracery, Universe

FABRIC GRADE LIST PRICE

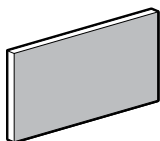

Tackboard

TB7018	1 x 70 x 18	92.5	12	1.10	1	\$357
					2	\$411
					3	\$454
					4	\$520
					5	\$598

For use on **G72HOCB** straight hutch. Includes mounting screws and covers.

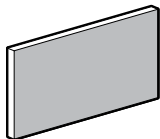

Tackboard

TB6918	1 x 69.5 x 18	92.5	12	1.05	1	\$357
					2	\$411
					3	\$454
					4	\$520
					5	\$598

For use on **G71HOCB** straight hutch. Includes mounting screws and covers.

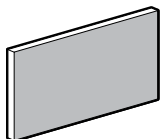

Tackboard

TB6718	1 x 67.5 x 18	92.5	12	1.05	1	\$357
					2	\$411
					3	\$454
					4	\$520
					5	\$598

For use on **G69HOCB** straight hutch. Includes mounting screws and covers.

Required Specifications

Fabric (Tackboards)

TACKBOARDS

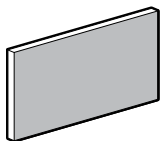

Tackboard

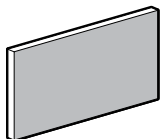

Tackboard

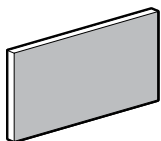

Tackboard

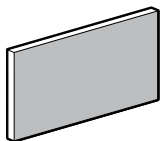

Tackboard

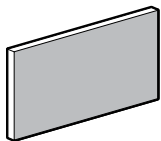

Tackboard

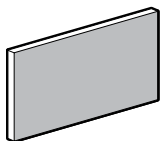

Tackboard

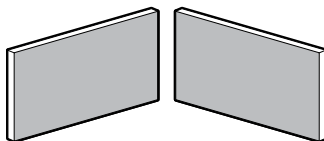

Tackboard

MODEL#	DIMENSIONS	FREIGHT CLASS	WT/LBS.	CUBIC FT.	FABRIC GRADE	LIST PRICE
--------	------------	---------------	---------	-----------	--------------	------------

D x W x H

TB6418	1 x 64 x 18	92.5	11	1	1	\$320
					2	\$368
					3	\$408
					4	\$467
					5	\$538

For use on **G66HOCB** straight hutch. Includes mounting screws and covers.

TB5818	1 x 58 x 18	92.5	10	.90	1	\$297
					2	\$340
					3	\$377
					4	\$428
					5	\$493

For use on **G60HOCB** straight hutch. Includes mounting screws and covers.

TB4618	1 x 46 x 18	92.5	9	.80	1	\$203
					2	\$240
					3	\$270
					4	\$313
					5	\$360

For use on **G48HOCB** straight hutch. Includes mounting screws and covers.

TB4018	1 x 40 x 18	92.5	8	.70	1	\$198
					2	\$229
					3	\$254
					4	\$292
					5	\$336

For use on **G42HOCB** straight hutch. Includes mounting screws and covers.

TB3818	1 x 38 x 18	92.5	7	.70	1	\$198
					2	\$228
					3	\$252
					4	\$289
					5	\$333

For use on **G40HOCB** straight hutch. Includes mounting screws and covers.

TB3418	1 x 34 x 18	92.5	6	.60	1	\$190
					2	\$219
					3	\$244
					4	\$280
					5	\$322

For use on **G36HOCB** straight hutch. Includes mounting screws and covers.

TB42CH	1 x 39-40 x 15	70	16	.85	1	\$357
					2	\$391
					3	\$423
					4	\$467
					5	\$538

For use on **G4242CH** corner hutch. Includes mounting screws and covers.

Required Specifications

Fabric

TACKBOARDS

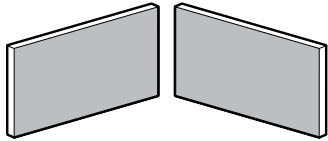

Tackboard

MODEL#	DIMENSIONS D x W x H	FREIGHT CLASS	WT./LBS.	CUBIC FT.	FABRIC GRADE	LIST PRICE
TB36CH	1 x 34 x 15	85	12	.85	1	\$343
					2	\$376
					3	\$401
					4	\$450
					5	\$518

For use on **G3636CH** corner hutch. Includes mounting screws and covers.

ACCESSORY PIECES

LIST PRICE



2 Drawer Lateral File*

G2036LF	20 x 36 x 29	100	145	15		\$825
---------	--------------	-----	-----	----	--	--------------

Two full suspension drawers. Front-to-back and side-to-side letter/legal filing capability with lock. Anti-lock tilt suspension.

- To comply with ANSI/BIFMA stability tests, the Lateral File Counter Weight Kit (model LFCWKIT36 - pg. 93) MUST be used.
- *Back of file is always Black.*
- *File drawer construction is for accommodating hanging files NOT for stacking materials on the drawer bottom.*

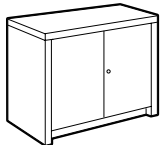

Storage Cabinet*

G2036SC	20 x 36 x 29	100	121	15		\$586
---------	--------------	-----	-----	----	--	--------------

Hinged doors cover one adjustable shelf. Standard with lock.

- *Back of storage cabinet is always Black.*

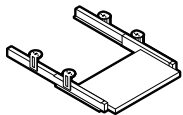

Pull-Out Keyboard

GPOKL28	11 x 28 x 3.5	85	13	.90		\$210
GPOKL22	11 x 22 x 3.5	85	11	.90		\$199

Constructed of thermofused laminate.

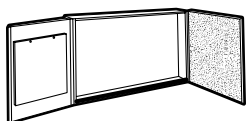

Visual Board

GVB4848	4 x 48 x 48	85	122	9.25		\$1200
---------	-------------	----	-----	------	--	---------------

Includes white board and two side opening doors containing cork board on right door and 50-sheet paper writing pad on left door. Marker board can be used for projection. Set of 4 dry markers and eraser included.

- **NOTE:** *Care should be taken to mount the units. Units should be mounted to wall studs using correct fasteners. Failure to do so may result in collapse of the unit and subsequent personal injury. **Mounting hardware not included.** Mounting hardware used should be based on wall material. Consult an installation professional for proper wall mounting.*

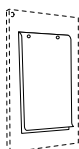

Flip Chart Pad

FC	30 x 20 x 30	92.5	20	2		\$277
----	--------------	------	----	---	--	--------------

Additional flip chart paper for double door visual boards. 50 sheets per book. Five pads per package. Price is per package.

Required Specifications

Fabric (tackboards)
Finish (accessories)

Optional Specifications

Key #*
Grommet (only G2036LF)

ACCESSORY PIECES

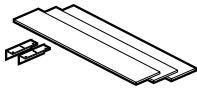

Counter Weight Kit

MODEL#	DIMENSIONS	FREIGHT CLASS	WT./LBS.	CUBIC FT.	LIST PRICE
--------	------------	---------------	----------	-----------	------------

	D x W x H				
LFCWKIT36	6 x 33 x 1	60	40	.25	\$533

3 metal plates. Plates mount to the underside of any 36" wide Lateral File or Mixed Storage/Drawer cabinet. Includes mounting hardware. Must be ordered separately. Field installed.

- To comply with ANSI/BIFMA stability tests, the Lateral File Counter Weight Kit MUST be used with the appropriate Lateral Files and Mixed Storage Cabinets.

BOOKCASES

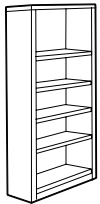

Bookcase - 84" High

GHBC84	12 x 36 x 84	125	198	26	\$1037
--------	--------------	-----	-----	----	---------------

One fixed heavy duty shelf and **four adjustable shelves**. Shipped fully assembled.

- *Not available in Constellation Java (CSJ)*

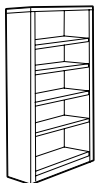

Bookcase - 72" High

GHBC72	12 x 36 x 72	100	173	20	\$866
--------	--------------	-----	-----	----	--------------

One fixed heavy duty shelf and **four adjustable shelves**. Shipped fully assembled.

- *Not available in Constellation Java (CSJ)*

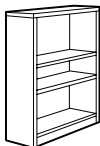

Bookcase - 48½" High

GHBC48	12 x 36 x 48	100	118	13.70	\$634
--------	--------------	-----	-----	-------	--------------

Two adjustable heavy duty shelves. Shipped fully assembled.

- *Not available in Constellation Java (CSJ)*

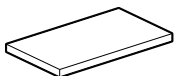

Bookcase Shelf

GHBCSHELF	12 x 34 x 1	100	13	1.60	\$161
-----------	-------------	-----	----	------	--------------

Extra shelf for bookcases. 1" thick.

Required Specifications

Finish (bookcases)



Halton was designed with both value and design in mind. A substantial edge treatment and hundreds of color combinations make Halton a series that will add flair to any office setting while still meeting budget requirements.

Halton's array of desks, returns and credenzas coordinate with any office decor and integrate easily with Global filing, storage, accessories and hutches. Whether you need a simple or a more complex office layout design, Halton can easily accommodate your workspace.

All desks, returns and credenzas offer ¾ or full to the floor pedestals. Choose from many solid and woodgrain laminate finishes to create unique, mix-and-match combinations or classic tone on tone finishes. For a great look at an even better price, Halton is an ideal choice.

Features and Benefits

- 45lb. density particle board substructure with high performance thermally fused laminate
- Available bow front desk provides extra legroom and work area for visitors
- ¾ modesty panel is standard; full modesty available
- 75lb. box - 150 lb. file drawer weight capacity with full height sides, plus pencil tray included in box drawer
- Box drawers mounted on ¾ extension steel ball bearings
- All drawers feature French dovetail joint in front and lapjoint in back
- Drawers open with side pull
- Compatible with **Divide, e0+ and GPS II** panel systems for increased privacy and storage requirements

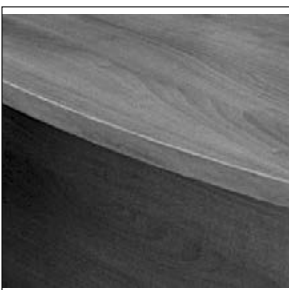

Bow front available on 36"x 72" desks



3mm edge top over side panel design



Full to floor pedestals available on all models

GENERAL INFORMATION

- Halton components are compatible with **GPS II, e0+ and Divide** partitioning panels.
- 3mm edge on all surfaces as well as drawer fronts
- Panel end style with top over side panel design
- Genoa desk and storage products have been tested and comply with all BIFMA mechanical tests.
- GREENGUARD INDOOR AIR QUALITY CERTIFICATION - Global laminate and seating products are in compliance with stringent emission guidelines set out by the Greenguard Environmental Institute under the standards for low emitting products and materials. www.greenguard.org.
- **Level 3 Certified**

CONSTRUCTION

- Constructed of 45 lb. density particleboard with high performance thermally fused laminate.
- All surfaces feature 3mm plastic edging in matching finish on all sides.
- Panel end style with top over side panel design
- Full to the floor pedestal configurations can be switched for a **15% upcharge**

MODESTY PANELS

- Recessed ¾ height modesty panel is standard. Full modesty panel is available... **Add \$51.**
- All full to floor units, bridges and returns are standard with a full modesty panel

LOCKS

- Standard on all box and file pedestals; file drawer and lower box drawer only lock.

FINISHES

- ACJ Absolute Acajou
- ASN Asian Night
- AWC Avant Cherry
- AWH Avant Honey
- BLK Black
- BRC Brushed Cobalt
- CSJ Constellation Java
- DES Dark Espresso
- HGT Hayden Grey
- QTM Quartered Mahogany
- SKC Shaker Cherry
- SOG Storm Grey
- TFW Tiger Fruitwood
- TMA Tiger Mahogany
- TMP Tiger Maple
- TWL Tiger Walnut
- WHT White
- WHC White Chocolate
- WGY Willow Grey
- WCR Winter Cherry

GROMMETS

- Additional grommets available in standard worksurface locations (left, center or right). Order as: **AG1, AG2 or AG3.....Add \$65**
- Grommet hole dimensions are 3 ¼" wide x 1 7/8" deep.



- Actual grommet locations on the worksurface are depicted in the example drawings shown below. Dimensions shown are actual measurements (in inches).

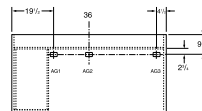

36 x 72 single pedestal left desks (3672SPL)

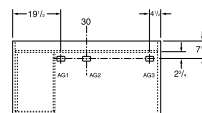

30 x 60 single pedestal left desks (3060SPL)

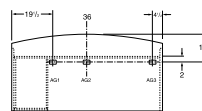

36 x 72 single pedestal left bow top desks (3672SLB)

- Grommets may be placed at non-standard locations. Order as: **AGS - Add \$65.** A drawing must be supplied with vertical and horizontal dimensions to the center of the cut-out (as in drawing above). Please refer to CUSTOM GROMMET LOCATION FORM in the back reference section.
- Components that come standard with grommet may be ordered without a grommet. **Add \$35.**

POWER BLOCK

- A Power Block (model **PMSPDM**) may be ordered on all worksurfaces.
- A Power Block is a rectangular worksurface power/data module with one electrical duplex receptacle and two data (RJ45) receptacles. 9 foot black cord included. Power Block dimensions are 3 ½" deep x 6 ½" wide x 2 ¾" high.
- To purchase a Power Block, you must specify both the Power Block cut-out location and the Power Block model #. Order Power Block as **PMSPDM, ADD \$238.** Power Blocks are available in standard worksurface locations (left, center or right). Order as **E1, E2 or E3. Add \$65.**

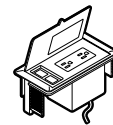

Power Block **PMSPDM Add \$238**

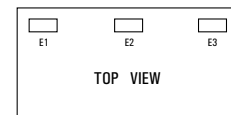

Specify location **E1, E2 or E3 Add \$65**

DOUBLE PEDESTAL DESKS

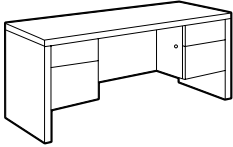

Double Pedestal Desk

MODEL#	DIMENSIONS	FREIGHT CLASS	WT/LBS.	CUBIC FT.	LIST PRICE
H3672DP	36 x 72 x 29	150	260	52.50	\$1085
H3072DP	30 x 72 x 29	150	229	43.75	\$1039
H3066DP	29.69 x 66 x 29	150	223	39.75	\$1010
H3060DP	29.69 x 60 x 29	125	218	36.25	\$907

Standard with box/file pedestals on both sides. Pedestals lock. One pencil tray.

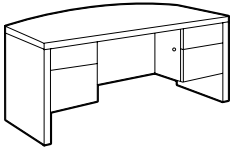

Double Pedestal Bow Top Desk

H3672DPB	30-36 x 72 x 29	150	258	52	\$1266
----------	-----------------	-----	-----	----	---------------

Standard with box/file pedestals on both sides and bow top. Pedestals lock. One pencil tray.

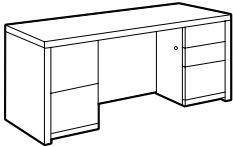

Full to Floor Double Pedestal Desk

H3672D4	36 x 72 x 29	150	306	52	\$1397
H3072D4	30 x 72 x 29	125	288	43.75	\$1360
H3066D4	29.69 x 60 x 29	125	271	39.75	\$1325
H3060D4	29.69 x 60 x 29	125	254	36.25	\$1218

Standard with box/box/file in right pedestal and file/file in left pedestal. Pedestals lock. One pencil tray. Full to the floor pedestal configurations can be switched for a **15% upcharge**.

- On full to the floor box/box/file pedestals, lower box drawer and file drawer lock.

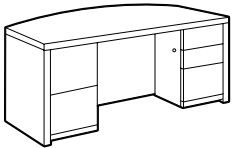

Full to Floor Double Pedestal Bow Top Desk

H3672DB4	30-36 x 72 x 29	150	288	52	\$1578
----------	-----------------	-----	-----	----	---------------

Standard with box/box/file in right pedestal and file/file in left pedestal. Bow top. Pedestals lock. One pencil tray. Full to the floor pedestal configurations can be switched for a **15% upcharge**.

- On full to the floor box/box/file pedestals, lower box drawer and file drawer lock.

SINGLE PEDESTAL DESKS

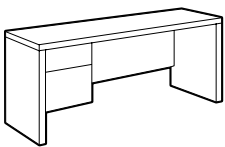

Single Pedestal Desk - LEFT

H3672SPL	36 x 72 x 29	150	218	52	\$951
H3072SPL	30 x 72 x 29	150	192	43.75	\$903
H3066SPL	29.69 x 66 x 29	150	182	39.75	\$848
H3060SPL	29.69 x 60 x 29	150	174	36.25	\$779
H3048SPL	29.69 x 48 x 29	150	157	29.50	\$756
H2448SPL	24 x 48 x 29	150	140	24.25	\$756
H2445SPL	24 x 45 x 29	150	132	22.50	\$629

Standard with box/file pedestal. Pedestal locks. One pencil tray. Pedestal is on the **left**.

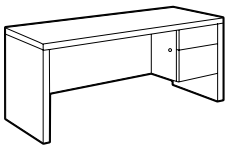

Single Pedestal Desk - RIGHT

H3672SPR	36 x 72 x 29	150	218	52	\$951
H3072SPR	30 x 72 x 29	150	192	43.75	\$903
H3066SPR	29.69 x 66 x 29	150	182	39.75	\$848
H3060SPR	29.69 x 60 x 29	150	174	36.25	\$779
H3048SPR	29.69 x 48 x 29	150	157	29.50	\$756
H2448SPR	24 x 48 x 29	125	168	24.25	\$756
H2445SPR	24 x 45 x 29	150	132	22.50	\$629

Standard with box/file pedestal. Pedestal locks. One pencil tray. Pedestal is on the **right**.

Required Specifications

Top finish
Base finish

Optional Specifications

Additional grommet
Key #

Accessories

Power block
Keyboard tray
Pencil tray

SINGLE PEDESTAL DESKS

MODEL# DIMENSIONS FREIGHT CLASS WT./LBS. CUBIC FT. LIST PRICE

D x W x H

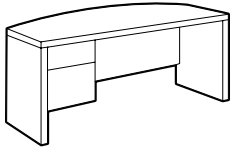

Single Pedestal Bow Top Desk - LEFT

H3672SLB 30-36 x 72 x 29 150 218 52 **\$1138**

Standard with box/file pedestal on **left** and bow top. Pedestal locks. One pencil tray.

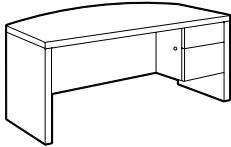

Single Pedestal Bow Top Desk - RIGHT

H3672SRB 36-36 x 72 x 29 150 218 52 **\$1138**

Standard with box/file pedestal on **right** and bow top. Pedestal locks. One pencil tray.

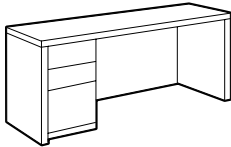

Full to Floor Single Pedestal Desk - LEFT

H3672S4L	36 x 72 x 29	150	247	52	\$1105
H3072S4L	30 x 72 x 29	150	218	43.75	\$1050
H3066S4L	29.69 x 66 x 29	150	209	39.75	\$1003
H3060S4L	29.69 x 60 x 29	150	200	36.25	\$935
H3048S4L	29.69 x 48 x 29	125	181	29.50	\$913
H2448S4L	24 x 48 x 29	125	168	24.25	\$913

Standard with full to floor box/box/file pedestal on the **left**. One pencil tray. Lower box drawer and file drawer lock. Full to the floor pedestal configurations can be switched for a **15% upcharge**.

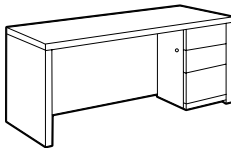

Full to Floor Single Pedestal Desk - RIGHT

H3672S4R	36 x 72 x 29	150	247	52	\$1105
H3072S4R	30 x 72 x 29	150	218	43.75	\$1050
H3066S4R	29.69 x 66 x 29	150	209	39.75	\$1003
H3060S4R	29.69 x 60 x 29	150	200	36.25	\$935
H3048S4R	29.69 x 48 x 29	125	181	29.50	\$913
H2448S4R	24 x 48 x 29	125	168	24.25	\$913

Standard with full to floor box/box/file pedestal on the **right**. One pencil tray. Lower box drawer and file drawer lock. Full to the floor pedestal configurations can be switched for a **15% upcharge**.

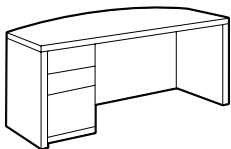

Full to Floor Single Pedestal Bow Top Desk - LEFT

H3672S4LB 30-36 x 72 x 29 150 234 52 **\$1293**

Standard with box/file pedestal on **left** and bow top. One pencil tray. Lower box drawer and file drawer lock. Full to the floor pedestal configurations can be switched for a **15% upcharge**.

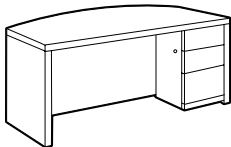

Full to Floor Single Pedestal Bow Top Desk - RIGHT

H3672S4RB 30-36 x 72 x 29 150 234 52 **\$1293**

Standard with box/file pedestal on **right** and bow top. One pencil tray. Lower box drawer and file drawer lock. Full to the floor pedestal configurations can be switched for a **15% upcharge**.

Required Specifications

Top finish
Base finish

Optional Specifications

Additional grommet
Key #

Accessories

Power block
Keyboard tray
Pencil tray

RETURNS

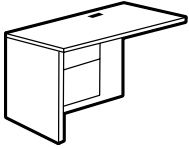

Flush Return - LEFT

MODEL#	DIMENSIONS D x W x H	FREIGHT CLASS	WT/LBS.	CUBIC FT.	LIST PRICE
H2448FL	24 x 48 x 29	150	133	24.25	\$645
H2442FL	24 x 42 x 29	150	123	21.25	\$638
H2042FL	20 x 42 x 29	150	104	18	\$623

Standard with box/file drawer pedestal. Pedestal locks. Grommet in worksurface. Pedestal is on the **left**.

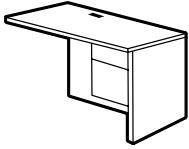

Flush Return - RIGHT

H2448FR	24 x 48 x 29	150	133	24.25	\$645
H2442FR	24 x 42 x 29	150	123	21.25	\$638
H2042FR	20 x 42 x 29	150	104	18	\$623

Standard with box/file drawer pedestal. Pedestal locks. Grommet in worksurface. Pedestal is on the **right**.

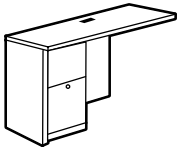

Full to Floor Flush Return - LEFT

H2448L4	24 x 48 x 29	125	148	24.25	\$802
H2442L4	24 x 42 x 29	125	139	21.25	\$793
H2042L4	20 x 42 x 29	125	120	18	\$779

Standard with file/file drawer pedestal. Pedestal locks. Grommet in worksurface. Pedestal is on the **left**.

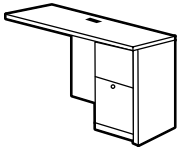

Full to Floor Flush Return - RIGHT

H2448R4	24 x 48 x 29	125	148	24.25	\$802
H2442R4	24 x 42 x 29	125	139	21.25	\$793
H2042R4	20 x 42 x 29	125	120	18	\$779

Standard with file/file drawer pedestal. Pedestal locks. Grommet in worksurface. Pedestal is on the **right**.

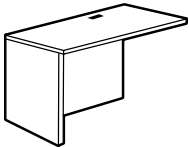

Flush Return - LEFT*

H2448EL	24 x 48 x 29	70	90	4.30	\$445
H2442EL	24 x 42 x 29	70	81	3.80	\$445
H2042EL	20 x 42 x 29	85	53	3.80	\$429

Return has no pedestal. Grommet in worksurface. Shipped RTA (ready to assemble).

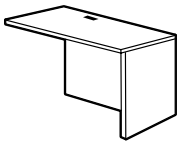

Flush Return - RIGHT*

H2448ER	24 x 48 x 29	70	90	4.30	\$445
H2442ER	24 x 42 x 29	70	81	3.80	\$445
H2042ER	20 x 42 x 29	85	53	3.80	\$429

Return has no pedestal. Grommet in worksurface. Shipped RTA (ready to assemble).

Required Specifications

Top finish
Base finish

Optional Specifications

Additional grommet
Key #

Accessories

Power block
Keyboard tray*
Pencil tray*

FLUSH BRIDGE

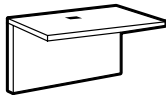

Flush Bridge

MODEL# DIMENSIONS FREIGHT CLASS WT./LBS. CUBIC FT. LIST PRICE

D x W x H

H2448FB	24 x 48 x 29	70	74	4.30	\$408
H2442FB	24 x 42 x 29	70	65	3.80	\$399
H2048FB	20 x 48 x 29	70	69	4.30	\$408
H2042FB	20 x 42 x 29	70	61	3.80	\$399

Top surface, back panel and hardware to connect two units. Grommet in worksurface. Shipped RTA (ready to assemble).

- **H2448/H2442** models will connect 66" and 72" units plus all D islands.
- **H2048/H2042** models will connect 60", 66" and 72" units plus all D islands and 5 sided corners.

CREDENZAS

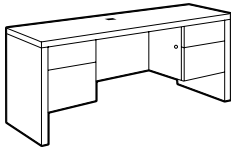

Kneespace Credenza

H2472CK	24 x 72 x 29	150	208	35.75	\$1077
H2466CK	24 x 66 x 29	125	200	32.75	\$996
H2072CK	20 x 72 x 29	125	187	30.25	\$1056
H2066CK	20 x 66 x 29	125	180	27.75	\$987
H2060CK	20 x 60 x 29	125	176	25.25	\$885

Standard with box/file pedestals on both sides. Center is open. Pedestals lock. One pencil tray. Grommet in worksurface.

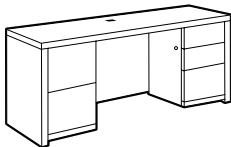

Full to Floor Kneespace Credenza

H2472D4	24 x 72 x 29	125	248	35.75	\$1391
H2466D4	24 x 66 x 29	125	240	32.75	\$1309
H2072D4	20 x 72 x 29	125	224	30.25	\$1368
H2066D4	20 x 66 x 29	125	216	27.75	\$1293
H2060D4	20 x 60 x 29	100	208	25.25	\$1196

Standard with full to floor box/box/file in right pedestal and file/file in left pedestal. Pedestals lock. One pencil tray. Full to the floor pedestal configurations can be switched for a **15% upcharge**.

- On full to the floor box/box/file pedestals, lower box drawer and file drawer lock.

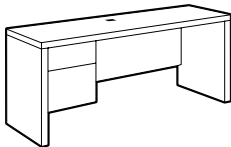

Single Pedestal Credenza - LEFT

H2472CSL	24 x 72 x 29	150	168	35.75	\$944
H2466CSL	24 x 66 x 29	150	160	32.75	\$868
H2072CSL	20 x 72 x 29	150	149	30.25	\$928
H2066CSL	20 x 66 x 29	150	142	27.75	\$854
H2060CSL	20 x 60 x 29	150	135	25.25	\$750

Standard with box/file pedestal. Pedestal locks. One pencil tray. Pedestal is on the **left**. Grommet in worksurface.

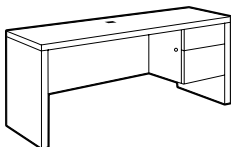

Single Pedestal Credenza - RIGHT

H2472CSR	24 x 72 x 29	150	168	35.75	\$944
H2466CSR	24 x 66 x 29	150	160	32.75	\$868
H2072CSR	20 x 72 x 29	150	149	30.25	\$928
H2066CSR	20 x 66 x 29	150	142	27.75	\$854
H2060CSR	20 x 60 x 29	150	135	25.25	\$750

Standard with box/file pedestal. Pedestal locks. One pencil tray. Pedestal is on the **right**. Grommet in worksurface.

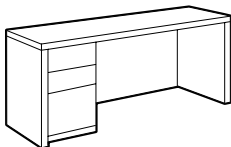

Full to Floor Single Pedestal Credenza - LEFT

H2472S4L	24 x 72 x 29	150	195	35.75	\$1100
H2466S4L	24 x 66 x 29	150	187	32.75	\$1026
H2072S4L	20 x 72 x 29	150	175	30.25	\$1085
H2066S4L	20 x 66 x 29	125	168	27.75	\$1010
H2060S4L	20 x 60 x 29	125	160	25.25	\$907

Standard with full to floor box/box/file pedestal on the **left**. One pencil tray. Lower box drawer and file drawer lock. Grommet in worksurface.

Required Specifications

Top finish
Base finish

Optional Specifications

Additional grommet
Key #

Accessories

Power block
Keyboard tray
Pencil tray

CREDENZAS

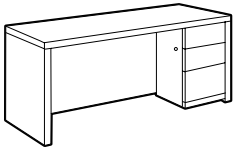

Full to Floor Single Pedestal Credenza - RIGHT**

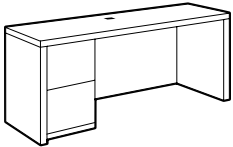

Full to Floor Single Pedestal Credenza - LEFT*

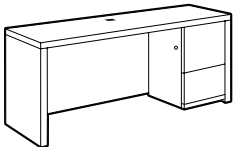

Full to Floor Single Pedestal Credenza - RIGHT*

MODEL#	DIMENSIONS	FREIGHT CLASS	WT/LBS.	CUBIC FT.	LIST PRICE
--------	------------	---------------	---------	-----------	------------

D x W x H

H2472S4R	24 x 72 x 29	150	196	35.75	\$1100
H2466S4R	24 x 66 x 29	150	187	32.75	\$1026
H2072S4R	20 x 72 x 29	150	175	30.25	\$1085
H2066S4R	20 x 66 x 29	125	168	27.75	\$1010
H2060S4R	20 x 60 x 29	125	160	25.25	\$903

Standard with full to floor box/box/file pedestal on the **right**. One pencil tray. Lower box drawer and file drawer lock. Grommet in worksurface.

H2472S2L	24 x 72 x 29	150	196	35.75	\$1100
H2466S2L	24 x 66 x 29	150	187	32.75	\$1026
H2072S2L	20 x 72 x 29	150	175	30	\$1085
H2066S2L	20 x 66 x 29	125	168	27.75	\$1010
H2060S2L	20 x 60 x 29	125	160	25.25	\$907

Standard with full to floor file/file pedestal on the **left**. Pedestal locks. Grommet in worksurface.

H2472S2R	24 x 72 x 29	150	196	35.75	\$1100
H2466S2R	24 x 66 x 29	150	187	32.75	\$1026
H2072S2R	20 x 72 x 29	150	175	30	\$1085
H2066S2R	20 x 66 x 29	125	168	27.75	\$1010
H2060S2R	20 x 60 x 29	125	160	25.25	\$907

Standard with full to floor file/file pedestal on the **right**. Pedestal locks. Grommet in worksurface.

ACCESSORIES

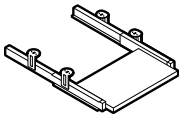

Pull-Out Keyboard

APOKL28	17 x 28 x 3.5	85	13	.90	\$245
APOKL22	17 x 22 x 3.5	85	12	.90	\$221

Constructed of thermofused laminate.

Required Specifications

Top finish
Base finish

Optional Specifications

Additional grommet*
Key #*

Accessories

Power block*
Keyboard tray**
Pencil tray**



The design of Princeton reflects the personality of today's young, dynamic workforce. The freestanding, modular components build out from you and where you work. With over 1000 available components, Princeton offers a flexible footprint that's simple to reconfigure. A variety of storage options allows you to do more with less space.

Princeton delivers contemporary design to the workplace; whether it be in Commercial and Corporate offices, Government offices, Small Businesses, Banking, Legal, Accounting, Hospitality or the professional home office. Every element, from the mix of materials and finishes to open storage pieces, floating modesties and overlapping surfaces, has been designed to provide visual appeal and intelligent function. Princeton is a freestanding and fully modular collection offering maximum flexibility; ease of installation and facilitates simple reconfigurations. The overlapping worksurface design also allows the footprint to adapt to smaller spaces by just a few inches.



Features and Benefits

- 1" thick worksurfaces in thermally fused or high pressure laminate
- Worksurfaces feature Global's preferred edging in matching color
- Optional tempered glass shelves with acid-etched finish on one side
- Counterweights standard on all mobile pedestals, lateral files and credenzas
- Handles & pulls in satin anodized finish standard on all credenza, pedestal drawers and cabinet doors
- Monoposts and hutch supports standard in tungsten finish
- Benches double as lateral filing
- Pull-out equipment shelves on select credenzas
- Energy efficient LED lighting for overhead storage cabinets
- Grommets and power blocks to accommodate power/data needs
- Choose glass or fabric equipment screens



Bench doubles as lateral filing



Pull out equipment shelf (printer not included)



Bookshelf with accessory hook

GENERAL INFORMATION

- Over 1000 components are available
- No cubicles or panels needed for configurations
- Product can be added and reconfigured as needed
- Princeton desk and storage products have been tested and comply with all BIFMA mechanical tests.
- Global laminate and seating products are in compliance with stringent emission guidelines set out by the Greenguard Environmental Institute under the standards for low emitting products and materials. www.greenguard.org
- **Level 2 Certified**

WORKSURFACES

- 1" thick high performance thermally fused laminate tops sealed with Global's preferred edging in matching color
- High Pressure Tops are available in all Princeton laminate finishes at an extended lead time. Please see model # for pricing and availability
- Worksurfaces with metal legs which have a span of 54" and over are standard with metal support channel.
24"D and 30"D - 1 support channel
36"D - 2 support channels

CONSTRUCTION

- Laminate end panel and metal leg products are **not intended** to be combined for the most visually compatible design. They are, however, interchangeable if required.
- All components, with the exception of worksurfaces, have 1mm thick matching edges
- Leveling glides are standard on all floor units.
- End panels are 1.5" thick on laminate end panel desks and credenzas. Cabinet end panels are 11/16" thick.
- 1" x 2" metal frame legs finished in Tungsten (**TUN**), Black (**BLK**) or Designer White (**DWT**) for desks and returns (closed 'O' style leg)
- 1" x 2.5" metal frame legs finished in Tungsten (**TUN**), Black (**BLK**) or Designer White (**DWT**) for freestanding tables (open 'U' style leg)
- Constructed of 45 lb. density particleboard with high performance thermally fused laminate.
- Mobile pedestals and mobile lateral files come standard with front locking casters
- Counterweights are standard on all pedestals, lateral files, credenzas and cabinets
- Stool and rolling table come standard with non-locking casters
- Laminate shelves are 11/16" thick and edged on all 4 sides. Tempered glass is 6mm thick with satin-etched finish on one side.
- Credenzas come standard with file bars for side-to-side and front-to-back letter and legal filing capability. File bars are not shipped with cabinets and pedestals.
- Handles and pulls in satin anodized finish are standard on all credenza, pedestal drawers and cabinet doors.
- Pull-out equipment shelves are available on select credenzas.
- Grommets and power blocks are available to accommodate power/data needs.

EDGE DETAILS

- All worksurfaces have Global's preferred matching edge detail on all sides
- All other components have 1mm thick edge detail on all sides
- Edging cannot be specified separately. No substitutions.

LAMINATE MODESTY PANELS

- Standard on all desks with laminate end panels, returns with laminate end panels and bridges for laminate end panel desks.
- Flush on Freestanding Returns with laminate end panels
- Recessed 4"D on 24"D desks with laminate end panels, 5"D on 30"D desks with laminate end panels and 6"D on 36"D desks with laminate end panels.
- Recessed 4"D on 24"D, 5"D on 30"D, and 6"D on 36"D flush and overlapping returns with laminate end panels.

- Recessed 4" on 24"D and 5"D on 30"D flush and overlapping bridges with laminate end panels.
- Desks and returns feature modesty panel that is flush with end panel
- Bottom of laminate modesty panel is 17 3/4" from floor.

GLASS DESKTOP PANELS

- Glass desktop panel is sold separately. See selection on page 134.
- Available for installation onto desks, returns, bridges and conference tops
- Made of 6mm tempered glass with satin-etched finish on one side
- On-site installation is required. Installation instructions will be provided.

FABRIC AND DESKTOP PANELS

- Fabric desktop and fabric modesty panels are sold separately. See selection on page 134.
- Available in:
Grade 1: Drama, Jenny, Lola, Quilt
Grade 2: Blink, Brinx, Coordinate, Mariposa, Quadrille, Quantum, Replay, Silhouette
Grade 3: Abstract, Accent, Cocktail, Identity, Stitch
Grade 5: Momentum: **Meander, Tracery and Universe (extended lead time)**
- On-site installation is required for fabric desktop and fabric modesty panels. Installation instructions will be provided.
- Non-tackable
- Bottom of fabric modesty panel is 15.5" from floor

STORAGE

- Roll-out shelf on credenza holds up to 80 lbs
- Laminate shelves are standard on storage cabinets. Tempered glass is available at an upcharge (varies by item; see product for details). Specify **TG**.
- All cabinets with side open shelf area that aligns with 29"H or 27"H credenzas - fixed shelf is 1" thick
- Recycling/waste drawer accommodates 1 recycling basket and 1 waste basket

CREDENZAS

- Available in 29", 27" and 23" heights
- 29"H connect to flush returns, flush conference tops and flush bridges
- 27"H connect to overlapping returns, overlapping conference tops and overlapping bridges
- Fixed drawer widths - see individual models for details
- Upper adjustable shelf must be removed when products with laminate modesty panels are installed (i.e. PN2448RFR flush return with laminate end panel or PN2436BF flush bridge for laminate end panel desk)
- Connection of flush or overlapping surfaces to credenzas is only possible over full height opening
- All credenza tops are 1" thick
- Grommet location is 2.5" from the back edge to the cut out edge

LOCKS

- Standard on all credenzas, storage cabinets, lateral files, pedestals & benches
- Lock on all credenzas, cabinets and pedestals is always on the bottom drawer
- All components within a workstation or private office can be keyed alike. For up to 20 key numbers, the lead times are standard. For projects larger than 20 offices, additional lock numbers are available. Delivery will be extended an additional week at no upcharge
- To order specified keying, tag each component of each workstation or office with a lock number between 101 and 120.
- Components may be ordered without locks at no additional charge. Specify **NL**
- Storage cabinets and pedestal with box/box/file drawer - only five drawer and lower box drawer are locking. Credenza file drawer lock secures both drawers.

HUTCHES & OVERHEAD STORAGE

- Available in 60", 66", 72", 78" and 84" widths
- Hutches with full back feature one small hole in each corner for wire pass through
- 15.75" height clearance between worksurface and underside of hutch
- Overhead Storage Cabinets have full width lower storage with center divider
- Hutches feature 1" x 2" steel support frame in Tungsten (**TUN**), Black (**BLK**) or Designer White (**DWT**)
- Laminate and tempered glass sliding doors available
- Hutches cannot be placed on desks with laminate end panels
- Wall hung mounting rails are provided; wall fastener hardware is not included.
- Locks are not available
- Energy efficient LED lighting available (page 159)

TABLES

- 1" x 2.5" open metal frame leg finished in Tungsten (**TUN**), Black (**BLK**) or Designer White (**DWT**)
- Standard with 1" thick top and Global's preferred edging in matching color
- 120" and 144" wide table tops with center leg are shipped in two pieces
- Tables which have a span of 54" or wider are standard with metal support channel(s)
- Grommets and power block cutouts are available for most tables. Due to support channel location(s), contact Customer Care for details.
- Available standard with levelers or locking casters

KEYBOARDS

- Keyboard tray adaptor kits are required to accommodate worksurface support channels on the following: freestanding desks with metal legs, returns with metal legs, bridges for desks and returns with metal legs, and returns with bookshelf.
- **PNDKK8** for single rail (track) keyboard tray
- **PNDKK30** for double rail keyboard tray

TACKBOARDS

- Tackboards available for hutches and overhead units.
- Available to fit 60", 66", 72" 78" and 84" widths
- Available in:
 - Grade 1:** Agate II
 - Grade 1:** Coordinate, Drama, Jenny, Lola, Pebbles, Quilt, Shard, Sprinkle, Station, Styx, Time, Urban
 - Grade 2:** Accent, Blink, Brinx, Couture, Crescent, Cumulus, Imprint, Mariposa, Match, Oxygen, Quadrille, Quantum, Renewal, Replay, Silhouette
 - Grade 3:** Identity, Stitch
 - Grade 4:** Presidio
 - Grade 5:** Momentum: **Meander, Tracery and Universe (extended lead time)**
- Contact customer care for COM selection.

CUSHIONS

- Sold separately.
- Cushions available in all Global seating fabrics. Contact customer care for COM selection and procedure.

CONNECTION

- Metal flat plates and wood screws are provided for connection between two units.

SPECIAL SIZES

- Custom widths, depths and heights are available, but require a custom quote. Please contact Customer Care for more information.
- Custom orders must indicate the "custom quote number" and list price as provided by Customer Care.
- Changes to a custom quote are not permissible. Any revisions will necessitate a new quotation.

TASK LIGHTS

- Optional, energy efficient LED task lights (ultra slim design) are available for mounting under hutches and overheads
- Hutches and overhead storage cabinets are pre-drilled for easy installation
- Available in 12", 20" and 40" widths

WIRE MANAGEMENT

- 2"W x 2"H
- Plastic tray flexes to receive and hold electrical and data wires
- Quickly attaches with double-sided tape (included)

MONOPOST

- Standard support for conference tops; support for select desks and returns
- 4" square post with 10" square base

PLANTERS

- Plastic planter pots provided
- 8½" diameter x 8"H
- Available in Black (BK) or White (WT). Must specify at time of order.

SHIPPING

- Items are shipped R.T.A. (Ready To Assemble) unless otherwise noted
- Shipped in 1 carton unless otherwise noted
- Connecting hardware included

1. SPECIFY MODEL NUMBER

2. SPECIFY FINISH

Top Finishes:

ACJ	Absolute Acajou
ASN	Asian Night
AWC	Avant Cherry
AWH	Avant Honey
DES	Dark Espresso
HGT	Hayden Grey
SKC	Shaker Cherry
TMA	Tiger Mahogany
TMP	Tiger Maple
TWL	Tiger Walnut
WCR	Winter Cherry
WHC	White Chocolate*
WHT	White

*textured, HP non-textured, top only

Base Finishes:

ACJ	Absolute Acajou
ASN	Asian Night
AWC	Avant Cherry
AWH	Avant Honey
DES	Dark Espresso
HGT	Hayden Grey
SKC	Shaker Cherry
TMA	Tiger Mahogany
TMP	Tiger Maple
TWL	Tiger Walnut
WCR	Winter Cherry
WHC	White Chocolate
WHT	White

Door, Drawer and Cabinet Front Finishes

ACJ	Absolute Acajou
ASN	Asian Night
AWC	Avant Cherry
AWH	Avant Honey
DES	Dark Espresso
HGT	Hayden Grey
SKC	Shaker Cherry
TMA	Tiger Mahogany
TMP	Tiger Maple
TWL	Tiger Walnut
WCR	Winter Cherry
WHC	White Chocolate
WHT	White

Monopost Finishes

4" square monopost is available in Tungsten (TUN), Black (BLK) or Designer White (DWT)

Metal Frame Desk Legs

1" x 2" metal frame legs are available in Tungsten (TUN), Black (BLK) or Designer White (DWT)

For detailed finish specification guidelines, please download the **Princeton Design Guide** at www.globalfurnituregroup.com

Planters

Planter pots are standard in white. Available in Black (BK) at no upcharge. MUST SPECIFY at time of order placement.

Metal Frame Table Legs

1" x 2.5" metal frame legs are available in Tungsten (TUN), Black (BLK) or Designer White (DWT)

3. SPECIFY OPTIONS

GROMMETS

- One grommet in satin anodized finish is standard on many components, as specified
- Additional grommets may be available in other standard worksurface locations (left, center or right)
- Order as: **Left POG1, Center POG2 or Right POG3: ADD \$65**

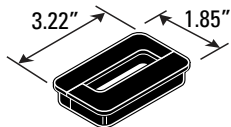

- Worksurface Grommet hole dimensions are 3.22" W x 1.85"D
- Standard grommet position is POG2 in desks, returns, bridges and conference tops
- Modesty panel pass through hole dimensions are 3.43"W x 2"H
- Grommets may be placed at non-standard locations. Order as **PCSG.....Add \$65**. A drawing must be supplied with vertical and horizontal dimensions to the center of the cut-out (as in drawing above)
- Components that come standard with grommet may be ordered without a grommet. Order as **RSG.....Add \$35**.
- Grommet only available at POG2 on the following 48"W worksurfaces:
 - Desk: PN2448DK, PN3048DK, PN3648DK
 - Return-Freestanding: PN244829R, PN244827R
 - Return-Flush: PN2448RFR, PN3048RFR, PN3648RFL, PN2448RFL, PN3048RFL, PN3648RFL

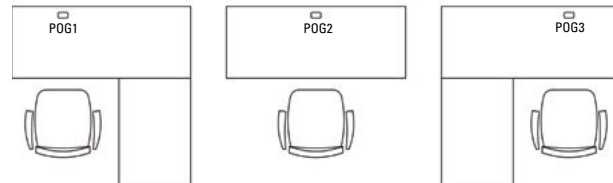
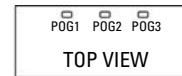

POWER BLOCK

- Power Block (model **PGDPS20**) with 1 power outlet and 1 data opening, 12 foot long power cord, for mounting under worksurfaces or inside of laminate end panels
- Power Block (model **PGDPS21**) with 2 power outlets and 1 data opening, 12 foot long power cord, for mounting under worksurfaces or inside of laminate end panels
- Power Bar (model **PGDPS41**) with 4 power outlets and 1 data opening, 12 foot long power cord, for mounting behind credenza pull-out shelf or at back of credenza opening
- Rectangular shape. Finished in Tungsten (TUN)
- Power Block dimensions:
 - PGDPS20: 2.5"D x 3.5"W x 2.25"H
 - PGDPS21: 2.5"D x 6.75"W x 2.25"H
- Power Bar dimensions:
 - PGDPS41: 2.5"D x 10.25"W x 2.22"H

FREESTANDING DESKS - LAMINATE END PANELS

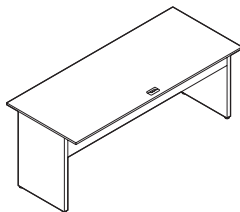

Freestanding Desk

MODEL#	DIMENSIONS D x W x H	FREIGHT CLASS	WT/LBS.	CUBIC FT.	LIST PRICE	HP ADD
PN2484DK	24 x 84 x 29	65	117	5	\$710	\$81
PN2478DK	24 x 78 x 29	70	111	5	\$689	\$80
PN2472DK	24 x 72 x 29	70	105	5	\$661	\$79
PN2466DK	24 x 66 x 29	65	101	4	\$653	\$79
PN2460DK	24 x 60 x 29	65	95	4	\$622	\$79
PN2454DK	24 x 54 x 29	60	95	3	\$622	\$80
PN2448DK	24 x 48 x 29	70	84	4	\$597	\$77
PN3084DK	30 x 84 x 29	70	133	6.50	\$721	\$83
PN3078DK	30 x 78 x 29	70	127	6	\$701	\$82
PN3072DK	30 x 72 x 29	70	120	5.50	\$679	\$82
PN3066DK	30 x 66 x 29	65	114	5	\$659	\$81
PN3060DK	30 x 60 x 29	70	109	5	\$634	\$79
PN3054DK	30 x 54 x 29	60	108	3.25	\$634	\$80
PN3048DK	30 x 48 x 29	65	98	4	\$605	\$79
PN3684DK	36 x 84 x 29	70	152	8	\$759	\$92
PN3678DK	36 x 78 x 29	70	145	7	\$737	\$89
PN3672DK	36 x 72 x 29	70	138	7	\$724	\$86
PN3666DK	36 x 66 x 29	70	130	6	\$692	\$82
PN3660DK	36 x 60 x 29	70	117	6	\$668	\$80
PN3654DK	36 x 54 x 29	60	120	4	\$668	\$81
PN3648DK	36 x 48 x 29	70	111.50	6.50	\$613	\$79

Standard with inset end panel on both ends and 10" h modesty panel with pass through grommet. Connects to flush return with laminate end panel, bridges for laminate end panel desks, flush return with bookshelf, flush conference tops. Can be placed over 27" H freestanding returns or 23" H/27" H credenzas. Grommet in worksurface. Shipped in 2 cartons.

RETURNS - LAMINATE END PANELS

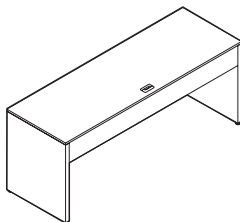

Freestanding Return- 29" H

PN248429R	24 x 84 x 29	65	131	5	\$693	\$91
PN247829R	24 x 78 x 29	65	127	5	\$673	\$87
PN247229R	24 x 72 x 29	65	123	5	\$655	\$83
PN246629R	24 x 66 x 29	65	118	4	\$623	\$81
PN246029R	24 x 60 x 29	65	112	4	\$618	\$79
PN245429R	24 x 54 x 29	60	95	3	\$618	\$80
PN244829R	24 x 48 x 29	65	103	4	\$613	\$78

Standard with flush laminate end panels. 10" h modesty panel without pass through grommet. Connects to flush return with laminate end panel, bridges for laminate end panel desks, flush return with bookshelf, flush conference tops. Can be placed over 27" H freestanding returns or 23" H/27" H credenzas. Grommet in worksurface.

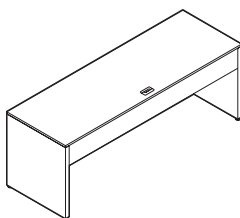

Freestanding Return- 27" H

PN248427R	24 x 84 x 27	65	129	5	\$684	\$88
PN247827R	24 x 78 x 27	65	125	5	\$663	\$85
PN247227R	24 x 72 x 27	65	120	5	\$645	\$82
PN246627R	24 x 66 x 27	65	116	4	\$626	\$80
PN246027R	24 x 60 x 27	65	109	4	\$584	\$78
PN245427R	24 x 54 x 27	60	95	3	\$584	\$79
PN244827R	24 x 48 x 27	65	101	4	\$553	\$77

Standard with flush laminate end panels. 10" h modesty panel without pass through grommet. Supports overlapping return with laminate end panel, overlapping bridge for laminate end panel desks, overlapping return with bookshelf, overlapping conference top. Can be placed under desk. Grommet in worksurface.

Required Specifications

Top finish
Base finish

Optional Specifications

HP laminate
POG1, POG3 - additional grommet
PCSG - custom grommet
RSG - remove grommet

Accessories

Power block
Keyboard tray
Keyboard mechanism (not available on 27" H return)

Wire manager
Desktop screen

RETURNS - LAMINATE END PANELS

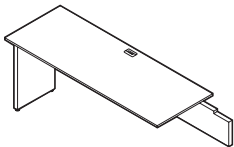

Flush Return - 29" H - LEFT

MODEL#	DIMENSIONS	FREIGHT CLASS	WT/LBS.	CUBIC FT.	LIST PRICE	HP ADD
D x W x H						
PN2478RFL	24 x 78 x 29	70	109	5.50	\$596	\$91
PN2472RFL	24 x 72 x 29	70	95	5.50	\$572	\$86
PN2466RFL	24 x 66 x 29	70	90	5	\$552	\$83
PN2460RFL	24 x 60 x 29	70	84	4.50	\$520	\$80
PN2454RFL	24 x 54 x 29	70	78	4	\$507	\$81
PN2448RFL	24 x 48 x 29	70	72	4	\$484	\$78
PN3078RFL	30 x 78 x 29	70	122	6.50	\$634	\$94
PN3072RFL	30 x 72 x 29	70	109	6.50	\$617	\$82
PN3066RFL	30 x 66 x 29	70	103	6	\$590	\$81
PN3060RFL	30 x 60 x 29	70	97	6	\$565	\$79
PN3054RFL	30 x 54 x 29	70	99	5	\$545	\$82
PN3048RFL	30 x 48 x 29	70	85	5	\$510	\$80
PN3678RFL	36 x 78 x 29	70	140	8	\$730	\$98
PN3672RFL	36 x 72 x 29	85	118	8	\$696	\$90
PN3666RFL	36 x 66 x 29	70	112	7	\$662	\$86
PN3660RFL	36 x 60 x 29	70	106	7	\$642	\$83
PN3654RFL	36 x 54 x 29	70	106	5.75	\$623	\$84
PN3648RFL	36 x 48 x 29	70	90	6	\$594	\$82

Return has no pedestal. Standard with inset end panel on **left**. 10" h modesty panel. Connects to Freestanding Desk with laminate end panels, **29" H** Freestanding Returns and **29" H** Credenzas. Grommet in worksurface.

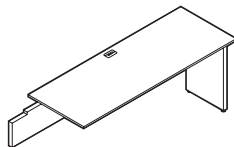

Flush Return - 29" H - RIGHT

PN2478RFR	24 x 78 x 29	70	109	5.50	\$596	\$91
PN2472RFR	24 x 72 x 29	70	95	5.50	\$572	\$86
PN2466RFR	24 x 66 x 29	70	90	5	\$552	\$83
PN2460RFR	24 x 60 x 29	70	84	4.50	\$520	\$80
PN2454RFR	24 x 54 x 29	70	88	4	\$507	\$81
PN2448RFR	24 x 48 x 29	70	72	4	\$484	\$78
PN3078RFR	30 x 78 x 29	70	122	6.50	\$634	\$94
PN3072RFR	30 x 72 x 29	70	109	6.50	\$617	\$82
PN3066RFR	30 x 66 x 29	70	103	6	\$590	\$81
PN3060RFR	30 x 60 x 29	70	97	6	\$565	\$79
PN3054RFR	30 x 54 x 29	70	99	5	\$545	\$82
PN3048RFR	30 x 48 x 29	70	85	5	\$510	\$80
PN3678RFR	36 x 78 x 29	70	140	8	\$730	\$98
PN3672RFR	36 x 72 x 29	85	118	8	\$696	\$90
PN3666RFR	36 x 66 x 29	70	112	7	\$662	\$86
PN3660RFR	36 x 60 x 29	70	106	7	\$642	\$83
PN3654RFR	36 x 54 x 29	70	106	5.75	\$623	\$84
PN3648RFR	36 x 48 x 29	70	90	6	\$594	\$82

Return has no pedestal. Standard with inset end panel on **right**. 10" h modesty panel. Connects to Freestanding Desk with laminate end panels, **29" H** Freestanding Returns and **29" H** Credenzas. Grommet in worksurface.

Required Specifications

Top finish
Base finish

Optional Specifications

HP laminate
POG1, POG3 - additional grommet
PCSG - custom grommet
RSG - remove grommet

Accessories

Power block
Keyboard tray
Desktop screen
Wire manager
Keyboard mechanism

RETURNS - LAMINATE END PANELS

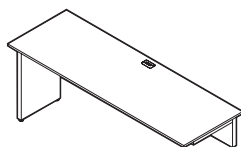

Overlapping Return - 29"H - LEFT

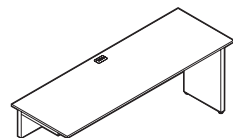

Overlapping Return - 29"H - RIGHT

MODEL#	DIMENSIONS D x W x H	FREIGHT CLASS	WT/LBS.	CUBIC FT.	LIST PRICE	HP ADD
PN2484ROL	24 x 84 x 29	70	118	6	\$634	\$71
PN2478ROL	24 x 78 x 29	65	126	5	\$591	\$70
PN2472ROL	24 x 72 x 29	70	104	5	\$571	\$66
PN3084ROL	30 x 84 x 29	70	140	7.50	\$686	\$77
PN3078ROL	30 x 78 x 29	65	149	6	\$644	\$75
PN3072ROL	30 x 72 x 29	70	123	6.50	\$621	\$71
PN3684ROL	36 x 84 x 29	70	162	9	\$734	\$81
PN3678ROL	36 x 78 x 29	65	168	7	\$705	\$79
PN3672ROL	36 x 72 x 29	70	141	7.50	\$692	\$76

Standard with inset laminate end panel on **left** and 10"h modesty panel. Overlaps **27"H** Credenza and **27"H** Freestanding Returns. Grommet in worksurface. 1" spacer included.

PN2484ROR	24 x 84 x 29	70	118	6	\$634	\$71
PN2478ROR	24 x 78 x 29	65	126	5	\$591	\$70
PN2472ROR	24 x 72 x 29	70	104	5	\$571	\$66
PN3084ROR	30 x 84 x 29	70	140	7.50	\$686	\$77
PN3078ROR	30 x 78 x 29	65	149	6	\$644	\$75
PN3072ROR	30 x 72 x 29	70	123	6.50	\$621	\$71
PN3684ROR	36 x 84 x 29	70	162	9	\$734	\$81
PN3678ROR	36 x 78 x 29	65	168	7	\$705	\$79
PN3672ROR	36 x 72 x 29	70	141	7.50	\$692	\$76

Standard with inset laminate end panel on **right** and 10"h modesty panel. Overlaps **27"H** Credenza and **27"H** Freestanding Returns. Grommet in worksurface. 1" spacer included.

BRIDGES FOR LAMINATE END PANEL DESKS

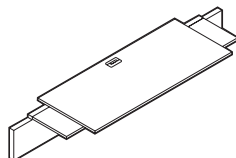

Flush Bridge

PN2454BF	24 x 54 x 12	65	97	3.50	\$451	\$70
PN2448BF	24 x 48 x 12	70	77	4.50	\$411	\$62
PN2442BF	24 x 42 x 12	70	70	4	\$392	\$59
PN2436BF	24 x 36 x 12	70	63	4	\$368	\$57
PN3054BF	30 x 54 x 12	65	112	4.50	\$470	\$70
PN3048BF	30 x 48 x 12	70	85	5.50	\$429	\$64
PN3042BF	30 x 42 x 12	70	80	5	\$411	\$61
PN3036BF	30 x 36 x 12	85	72	5	\$392	\$60

Standard with 10"h modesty panel. Connects between any two: Freestanding Desk with laminate end panels, **29"H** Freestanding Returns, Conference top for U configurations or **29"H** Credenzas opening. Subtop finish is Granite with black edge. Grommet in worksurface.

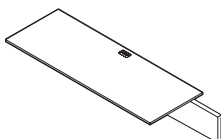

Overlapping Bridge - LEFT

PN2478BOL	24 x 78 x 12	65	119	4	\$540	\$79
PN2472BOL	24 x 72 x 12	70	96	5	\$513	\$72
PN2466BOL	24 x 66 x 12	70	90	4.50	\$496	\$66
PN2460BOL	24 x 60 x 12	70	83	4.50	\$488	\$64
PN3078BOL	30 x 78 x 12	65	134	5	\$565	\$84
PN3072BOL	30 x 72 x 12	70	112	6	\$530	\$74
PN3066BOL	30 x 66 x 12	70	104	6	\$512	\$71
PN3060BOL	30 x 60 x 12	70	96	5.50	\$497	\$68

Standard with 10"h modesty panel. Connects Freestanding Desk with laminate end panels, **29"H** Freestanding Returns, Conference top for U configurations on one end, and overlaps **27"H** Credenza or **27"H** Freestanding Return on other end. Subtop finish is Granite with black edge. Grommet in worksurface. Includes 1" spacer, one side only.

Required Specifications

Top finish
Base finish

Optional Specifications

HP laminate
POG1, POG3 - additional grommet
PCSG - custom grommet
RSG - remove grommet

Accessories

Power block
Wire manager

BRIDGES FOR LAMINATE END PANEL DESKS

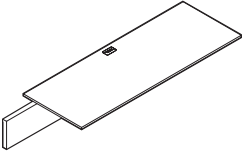

Overlapping Bridge - RIGHT

MODEL#	DIMENSIONS D x W x H	FREIGHT CLASS	WT/LBS.	CUBIC FT.	LIST PRICE	HP ADD
PN2478BOR	24 x 78 x 12	65	119	4	\$540	\$79
PN2472BOR	24 x 72 x 12	70	96	5	\$513	\$72
PN2466BOR	24 x 66 x 12	70	90	4.50	\$496	\$66
PN2460BOR	24 x 60 x 12	70	83	4.50	\$488	\$64
PN3078BOR	30 x 78 x 12	65	134	5	\$565	\$84
PN3072BOR	30 x 72 x 12	70	112	6	\$530	\$74
PN3066BOR	30 x 66 x 12	70	104	6	\$512	\$71
PN3060BOR	30 x 60 x 12	70	96	5.50	\$497	\$68

Standard with 10" h modesty panel. Connects Freestanding Desk with laminate end panels, **29" H** Freestanding Returns, Conference top for U configurations on one end, and overlaps **27" H** Credenza or **27" H** Freestanding Return on other end. Subtop finish is Granite with black edge. Grommet in worksurface. Includes 1" spacer, one side only.

FREESTANDING DESKS WITH METAL LEGS

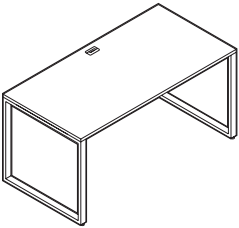

Freestanding Desk with Metal Legs*

PN2484DM	24 x 84 x 29	250	111	43.41	\$1098	\$172
PN2478DM	24 x 78 x 29	250	109	41.92	\$1015	\$160
PN2472DM	24 x 72 x 29	250	106	38.92	\$889	\$141
PN2466DM	24 x 66 x 29	250	102	31.44	\$881	\$139
PN2460DM	24 x 60 x 29	250	91	29.94	\$862	\$137
PN2454DM	24 x 54 x 29	250	88	29.94	\$836	\$133
PN2448DM	24 x 48 x 29	250	76	28.44	\$740	\$118
PN3084DM	30 x 84 x 29	250	137	53.89	\$1142	\$179
PN3078DM	30 x 78 x 29	250	124	52.40	\$1061	\$167
PN3072DM	30 x 72 x 29	250	117	47.90	\$950	\$150
PN3066DM	30 x 66 x 29	250	110	38.92	\$918	\$145
PN3060DM	30 x 60 x 29	250	104	38.17	\$889	\$141
PN3054DM	30 x 54 x 29	250	99	37.43	\$871	\$138
PN3048DM	30 x 48 x 29	250	82	35.93	\$769	\$123
PN3684DM	36 x 84 x 29	250	154	65.87	\$1296	\$202
PN3678DM	36 x 78 x 29	250	139	62.87	\$1187	\$185
PN3672DM	36 x 72 x 29	250	132	59.88	\$1155	\$181
PN3666DM	36 x 66 x 29	250	123	47.16	\$1012	\$159
PN3660DM	36 x 60 x 29	250	117	46.41	\$978	\$154
PN3654DM	36 x 54 x 29	250	106	44.91	\$923	\$146
PN3648DM	36 x 48 x 29	250	92	44.91	\$835	\$133

Standard with two 1" x 2" metal open frame legs with support channel(s). Connects to flush returns with metal leg, bridges for desks and returns with metal leg, flush return with bookshelf and flush conference tops. Grommet in worksurface. Shipped in 3 cartons.

Required Specifications

Top finish
Base finish (not PNxxxxDM)
Leg finish*

Optional Specifications

HP laminate
POG1, POG3 - additional grommet
PCSG - custom grommet
RSG - remove grommet

Accessories

Power block
Keyboard tray
Desktop screen
Keyboard tray mounting kit
Wire manager
Keyboard mechanism

FREESTANDING DESKS WITH METAL LEGS

MODEL#	DIMENSIONS	FREIGHT CLASS	WT/LBS.	CUBIC FT.	LIST PRICE	HP ADD
D x W x H						
PN2460DBL	24 x 60 x 29	250	106	40.42	\$936	\$152 \$71
PN2466DBL	24 x 66 x 29	250	117	41.17	\$1036	\$167 \$71
PN2472DBL	24 x 72 x 29	250	121	50.90	\$1063	\$172 \$71
PN2478DBL	24 x 78 x 29	250	131	50.90	\$1129	\$185 \$71
PN2484DBL	24 x 84 x 29	250	126	53.89	\$1211	\$195 \$71
PN3060DBL	30 x 60 x 29	250	123	51.65	\$965	\$160 \$86
PN3066DBL	30 x 66 x 29	250	129	52.40	\$1066	\$175 \$86
PN3072DBL	30 x 72 x 29	250	136	61.38	\$1098	\$178 \$86
PN3078DBL	30 x 78 x 29	250	150	65.87	\$1186	\$193 \$86
PN3084DBL	30 x 84 x 29	250	156	67.37	\$1250	\$217 \$86
PN3660DBL	36 x 60 x 29	250	139	59.88	\$1015	\$160 \$86
PN3666DBL	36 x 66 x 29	250	145	60.63	\$1115	\$175 \$86
PN3672DBL	36 x 72 x 29	250	154	73.35	\$1140	\$178 \$86
PN3678DBL	36 x 78 x 29	250	161	76.35	\$1237	\$193 \$86
PN3684DBL	36 x 84 x 29	250	176	79.34	\$1395	\$217 \$86

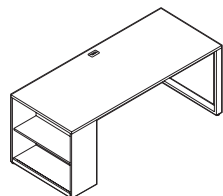

LEFT
Freestanding Desk with Bookshelf

12"D Bookcase with adjustable shelf on **left**. One 1" x 2" metal open frame leg with support channel(s). **Right** side connects to flush returns with metal leg, bridges for desks and returns with metal leg, flush return with bookshelf, flush conference tops. Grommet in worksurface. Shipped in 3 cartons.

PN2460DBR	24 x 60 x 29	250	106	40.42	\$936	\$148 \$56
PN2466DBR	24 x 66 x 29	250	117	41.17	\$1036	\$163 \$56
PN2472DBR	24 x 72 x 29	250	121	50.90	\$1063	\$167 \$56
PN2478DBR	24 x 78 x 29	250	131	50.90	\$1129	\$177 \$56
PN2484DBR	24 x 84 x 29	250	126	53.89	\$1211	\$189 \$56
PN3060DBR	30 x 60 x 29	250	123	51.65	\$965	\$148 \$56
PN3066DBR	30 x 66 x 29	250	129	52.40	\$1066	\$163 \$56
PN3072DBR	30 x 72 x 29	250	136	61.38	\$1098	\$167 \$56
PN3078DBR	30 x 78 x 29	250	150	65.87	\$1186	\$177 \$56
PN3084DBR	30 x 84 x 29	250	156	67.37	\$1250	\$189 \$56
PN3660DBR	36 x 60 x 29	250	139	59.88	\$1015	\$152 \$71
PN3666DBR	36 x 66 x 29	250	145	60.63	\$1115	\$167 \$71
PN3672DBR	36 x 72 x 29	250	154	73.35	\$1140	\$172 \$71
PN3678DBR	36 x 78 x 29	250	161	76.35	\$1237	\$185 \$71
PN3684DBR	36 x 84 x 29	250	176	79.34	\$1395	\$195 \$71

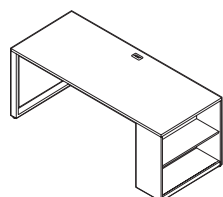

RIGHT
Freestanding Desk with Bookshelf

12"D Bookcase with adjustable shelf on **right**. One 1" x 2" metal open frame leg with support channel(s). **Left** side connects to flush returns with metal leg, bridges for desks and returns with metal leg, flush return with bookshelf, flush conference tops. Grommet in worksurface. Shipped in 3 cartons.

Required Specifications

Top finish
Base finish
Leg finish

Optional Specifications

HP laminate
POG1, POG3 - additional grommet
PCSG - custom grommet
RSG - remove grommet

Accessories

Power block
Keyboard tray
Desktop screen
Keyboard tray mounting kit
Wire manager
Keyboard mechanism

RETURNS WITH METAL LEGS

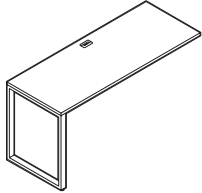

LEFT

Flush Return with Metal Leg

MODEL#	DIMENSIONS	FREIGHT CLASS	WT/LBS.	CUBIC FT.	LIST PRICE	HP ADD
D x W x H						
PN2448FML	24 x 48 x 29	150	56	12	\$511	\$77
PN2454FML	24 x 54 x 29	150	68	13	\$614	\$92
PN2460FML	24 x 60 x 29	150	71	13	\$643	\$97
PN2466FML	24 x 66 x 29	150	82	14	\$668	\$101
PN2472FML	24 x 72 x 29	150	86	20	\$690	\$104
PN2478FML	24 x 78 x 29	150	89	21	\$768	\$116
PN3048FML	30 x 48 x 29	150	61	15	\$542	\$82
PN3054FML	30 x 54 x 29	150	78	16	\$640	\$96
PN3060FML	30 x 60 x 29	150	82	16.50	\$669	\$101
PN3066FML	30 x 66 x 29	150	89	17	\$693	\$104
PN3072FML	30 x 72 x 29	150	96	23	\$736	\$111
PN3078FML	30 x 78 x 29	250	103	26	\$806	\$121
PN3648FML	36 x 48 x 29	250	70	19	\$574	\$87
PN3654FML	36 x 54 x 29	150	84	19	\$672	\$101
PN3660FML	36 x 60 x 29	150	95	20	\$713	\$107
PN3666FML	36 x 66 x 29	150	101	20.50	\$765	\$115
PN3672FML	36 x 72 x 29	250	110	29	\$905	\$136
PN3678FML	36 x 78 x 29	250	117	31	\$867	\$130

1" x 2" metal open frame leg with support channel(s) on **left**. Connects to freestanding desk with metal legs, freestanding desk with bookshelf and metal leg, 29"H credenza opening. Grommet in worksurface. Shipped in 2 cartons.

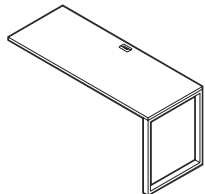

RIGHT

Flush Return with Metal Leg

PN2448FMR	24 x 48 x 29	150	56	12	\$511	\$77
PN2454FMR	24 x 54 x 29	150	68	13	\$614	\$92
PN2460FMR	24 x 60 x 29	150	71	13	\$643	\$97
PN2466FMR	24 x 66 x 29	150	82	14	\$668	\$101
PN2472FMR	24 x 72 x 29	150	86	20	\$690	\$104
PN2478FMR	24 x 78 x 29	150	89	21	\$768	\$116
PN3048FMR	30 x 48 x 29	150	61	7.50	\$542	\$82
PN3054FMR	30 x 54 x 29	150	78	16	\$640	\$96
PN3060FMR	30 x 60 x 29	150	83	16.50	\$669	\$101
PN3066FMR	30 x 66 x 29	150	89	17	\$693	\$104
PN3072FMR	30 x 72 x 29	150	96	23	\$736	\$111
PN3078FMR	30 x 78 x 29	250	103	26	\$806	\$121
PN3648FMR	36 x 48 x 29	250	70	19	\$574	\$87
PN3654FMR	36 x 54 x 29	150	84	19	\$672	\$101
PN3660FMR	36 x 60 x 29	150	95	20.50	\$713	\$107
PN3666FMR	36 x 66 x 29	150	101	20.50	\$765	\$115
PN3672FMR	36 x 72 x 29	250	110	29	\$905	\$136
PN3678FMR	36 x 78 x 29	250	117	31	\$867	\$130

1" x 2" metal open frame leg with support channel(s) on **right**. Connects to freestanding desk with metal legs, freestanding desk with bookshelf and metal leg, 29"H credenza opening. Grommet in worksurface. Shipped in 2 cartons.

Required Specifications

Top finish
Leg finish

Optional Specifications

HP laminate
POG1, POG3 - additional grommet
PCSG - custom grommet
RSG - remove grommet

Accessories

Power block
Keyboard tray
Desktop screen
Keyboard tray mounting kit
Wire manager
Keyboard mechanism

RETURNS WITH METAL LEGS

MODEL# DIMENSIONS FREIGHT CLASS WT/LBS. CUBIC FT. LIST PRICE HP ADD

D x W x H

PN3048FTL	30 x 48 x 29	150	61	15	\$535	\$81
PN3054FTL	30 x 54 x 29	150	78	16	\$632	\$95
PN3060FTL	30 x 60 x 29	150	83	16.50	\$669	\$101
PN3066FTL	30 x 66 x 29	150	89	17	\$707	\$106
PN3072FTL	30 x 72 x 29	150	96	23	\$736	\$111
PN3078FTL	30 x 78 x 29	250	103	26	\$821	\$124

PN3648FTL	36 x 48 x 29	250	70	19	\$574	\$87
PN3654FTL	36 x 54 x 29	150	84	19	\$664	\$100
PN3660FTL	36 x 60 x 29	150	95	20	\$713	\$107
PN3666FTL	36 x 66 x 29	150	101	20.50	\$750	\$113
PN3672FTL	36 x 72 x 29	250	110	29	\$898	\$135
PN3678FTL	36 x 78 x 29	250	117	31	\$874	\$132

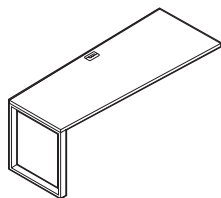

LEFT

Flush Wedge Return w/Metal Leg

1" x 2" metal open frame leg with support channel(s) on **left**. 30"D has 24"D leg. 36"D has 30"D leg. Connects to freestanding desk with metal legs, freestanding desk with bookshelf and metal leg, 29"H credenza opening. Grommet in worksurface. Shipped in 2 cartons.

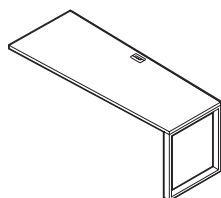

RIGHT

Flush Wedge Return w/Metal Leg

PN3048FTR	30 x 48 x 29	150	61	15	\$535	\$81
PN3054FTR	30 x 54 x 29	150	78	16	\$632	\$95
PN3060FTR	30 x 60 x 29	150	83	16.50	\$669	\$101
PN3066FTR	30 x 66 x 29	150	89	17	\$707	\$106
PN3072FTR	30 x 72 x 29	150	96	23	\$736	\$111
PN3078FTR	30 x 78 x 29	250	103	26	\$821	\$124

PN3648FTR	36 x 48 x 29	250	70	19	\$574	\$87
PN3654FTR	36 x 54 x 29	150	84	19	\$664	\$100
PN3660FTR	36 x 60 x 29	150	95	20	\$713	\$107
PN3666FTR	36 x 66 x 29	150	101	20.50	\$750	\$113
PN3672FTR	36 x 72 x 29	250	110	29	\$898	\$135
PN3678FTR	36 x 78 x 29	250	117	31	\$874	\$132

1" x 2" metal open frame leg with support channel(s) on **right**. 30"D has 24"D leg. 36"D has 30"D leg. Connects to freestanding desk with metal legs, freestanding desk with bookshelf and metal leg, 29"H credenza opening. Grommet in worksurface. Shipped in 2 cartons.

PN2460OML	24 x 60 x 29	150	71	13	\$573	\$86
PN2466OML	24 x 66 x 29	150	82	14	\$590	\$89
PN2472OML	24 x 72 x 29	150	86	20	\$611	\$92
PN2478OML	24 x 78 x 29	150	89	21	\$728	\$110
PN2484OML	24 x 84 x 29	150	91	22	\$842	\$127

PN3060OML	30 x 60 x 29	150	83	16.50	\$599	\$90
PN3066OML	30 x 66 x 29	150	89	17	\$621	\$94
PN3072OML	30 x 72 x 29	150	96	23	\$657	\$99
PN3078OML	30 x 78 x 29	250	103	26	\$781	\$118
PN3084OML	30 x 84 x 29	150	116	27	\$873	\$131

PN3660OML	36 x 60 x 29	150	95	20	\$699	\$105
PN3666OML	36 x 66 x 29	150	101	20.50	\$728	\$110
PN3672OML	36 x 72 x 29	250	110	29	\$763	\$115
PN3678OML	36 x 78 x 29	250	118	31	\$879	\$132
PN3684OML	36 x 84 x 29	150	132	33	\$955	\$144

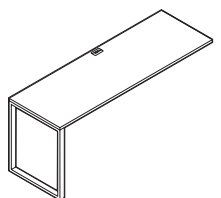

LEFT

Overlapping Return w/Metal Leg

1" x 2" metal open frame leg with support channels on **left**. Overlaps 27"H credenza opening. Grommet in worksurface. Shipped in 2 cartons.

Required Specifications

Top finish
Leg finish

Optional Specifications

HP laminate
POG1, POG3 - additional grommet
PCSG - custom grommet
RSG - remove grommet

Accessories

Power block
Keyboard tray
Desktop screen
Keyboard tray mounting kit
Wire manager
Keyboard mechanism

OVERLAPPING RETURNS WITH METAL LEGS

MODEL# DIMENSIONS FREIGHT CLASS WT/LBS. CUBIC FT. LIST PRICE HP ADD

D x W x H

PN2460OMR	24 x 60 x 29	150	71	13	\$573	\$86
PN2466OMR	24 x 66 x 29	150	82	14	\$590	\$89
PN2472OMR	24 x 72 x 29	150	86	20	\$611	\$92
PN2478OMR	24 x 78 x 29	150	89	21	\$728	\$110
PN2484OMR	24 x 84 x 29	150	91	22	\$842	\$127
PN3060OMR	30 x 60 x 29	150	83	16.50	\$599	\$90
PN3066OMR	30 x 66 x 29	150	89	17	\$621	\$94
PN3072OMR	30 x 72 x 29	150	96	23	\$657	\$99
PN3078OMR	30 x 78 x 29	250	103	26	\$781	\$118
PN3084OMR	30 x 84 x 29	150	137	27	\$873	\$131
PN3660OMR	36 x 60 x 29	150	95	20	\$699	\$105
PN3666OMR	36 x 66 x 29	150	101	20.50	\$728	\$110
PN3672OMR	36 x 72 x 29	250	110	29	\$763	\$115
PN3678OMR	36 x 78 x 29	250	117	31	\$879	\$132
PN3684OMR	36 x 84 x 29	150	132	33	\$955	\$144

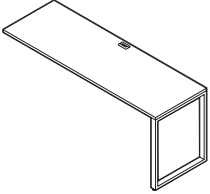

RIGHT

Overlapping Return w/Metal Leg

1" x 2" metal open frame leg with support channels on **right**. Overlaps 27"H credenza opening. Grommet in worksurface. Shipped in 2 cartons.

PN3060OTL	30 x 60 x 29	150	83	16.50	\$612	\$92
PN3066OTL	30 x 66 x 29	150	89	17	\$633	\$95
PN3072OTL	30 x 72 x 29	150	96	23	\$663	\$100
PN3078OTL	30 x 78 x 29	250	103	26	\$793	\$119
PN3084OTL	30 x 84 x 29	150	116	27	\$885	\$133

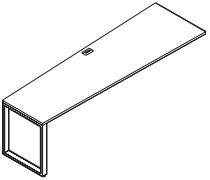

LEFT

Overlapping Wedge Return w/Metal Leg

PN3660OTL	36 x 60 x 29	150	95	20	\$712	\$107
PN3666OTL	36 x 66 x 29	150	101	20.50	\$740	\$111
PN3672OTL	36 x 72 x 29	150	132	29	\$767	\$115
PN3678OTL	36 x 78 x 29	250	117	31	\$892	\$134
PN3684OTL	36 x 84 x 29	150	132	33	\$967	\$145

1" x 2" metal open frame leg with support channel on **left**. 30"D has 24"D leg. 36"D has 30"D leg. Overlaps 27"H credenza opening. Grommet in worksurface. Includes 1" spacer. Shipped in 2 cartons.

PN3060OTR	30 x 60 x 29	150	83	16.50	\$612	\$92
PN3066OTR	30 x 66 x 29	150	89	17	\$633	\$95
PN3072OTR	30 x 72 x 29	150	96	23	\$663	\$100
PN3078OTR	30 x 78 x 29	250	103	26	\$793	\$119
PN3084OTR	30 x 84 x 29	150	116	27	\$885	\$133

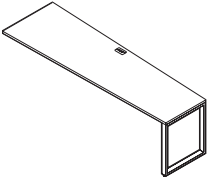

RIGHT

Overlapping Wedge Return w/Metal Leg

PN3660OTR	36 x 60 x 29	150	95	20	\$712	\$107
PN3666OTR	36 x 66 x 29	150	101	20.50	\$740	\$111
PN3672OTR	36 x 72 x 29	250	110	29	\$767	\$115
PN3678OTR	36 x 78 x 29	250	117	31	\$892	\$134
PN3684OTR	36 x 84 x 29	150	132	33	\$967	\$145

1" x 2" metal open frame leg with support channel on **right**. 30"D has 24"D leg. 36"D has 30"D leg. Overlaps 27"H credenza opening. Grommet in worksurface. Includes 1" spacer. Shipped in 2 cartons.

Required Specifications

Top finish
Leg finish

Optional Specifications

HP laminate
POG1, POG3 - additional grommet
PCSG - custom grommet
RSG - remove grommet

Accessories

Power block
Keyboard tray
Desktop screen
Keyboard tray mounting kit
Wire manager
Keyboard mechanism

OVERLAPPING RETURNS WITH METAL LEGS

MODEL# DIMENSIONS FREIGHT CLASS WT/LBS. CUBIC FT. LIST PRICE HP ADD

D x W x H

PN2460SOL	24 x 60 x 29	250	83	23.95	\$843	\$127
PN2466SOL	24 x 66 x 29	250	94	25.45	\$868	\$131
PN2472SOL	24 x 72 x 29	250	98	34.43	\$892	\$134
PN2478SOL	24 x 78 x 29	250	101	35.93	\$969	\$146
PN2484SOL	24 x 84 x 29	250	103	37.43	\$1021	\$154

PN3060SOL	30 x 60 x 29	250	95	26.20	\$897	\$135
PN3066SOL	30 x 66 x 29	250	101	26.95	\$923	\$139
PN3072SOL	30 x 72 x 29	250	108	35.93	\$946	\$142
PN3078SOL	30 x 78 x 29	250	115	40.42	\$1013	\$152
PN3084SOL	30 x 84 x 29	250	128	41.92	\$1081	\$163

PN3660SOL	36 x 60 x 29	250	107	28.44	\$996	\$150
PN3666SOL	36 x 66 x 29	250	113	29.19	\$1028	\$155
PN3672SOL	36 x 72 x 29	250	144	41.92	\$1142	\$172
PN3678SOL	36 x 78 x 29	250	129	44.91	\$1108	\$167
PN3684SOL	36 x 84 x 29	250	144	47.90	\$1149	\$173

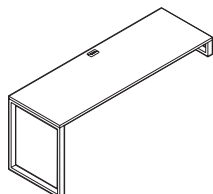

LEFT

Overlapping Return w/Metal Leg and Spacer for 23"H Credenza

1" x 2" metal frame leg on **left**. One 5"H metal frame spacer with support channel(s). Overlaps 23"H credenza. Grommet in worksurface. Shipped in 3 cartons.

PN2460SOR	24 x 60 x 29	250	83	23.95	\$843	\$127
PN2466SOR	24 x 66 x 29	250	94	25.45	\$868	\$131
PN2472SOR	24 x 72 x 29	250	98	34.43	\$892	\$134
PN2478SOR	24 x 78 x 29	250	101	35.93	\$969	\$146
PN2484SOR	24 x 84 x 29	250	103	37.43	\$1021	\$154

PN3060SOR	30 x 60 x 29	250	95	26.20	\$897	\$135
PN3066SOR	30 x 66 x 29	250	101	26.95	\$923	\$139
PN3072SOR	30 x 72 x 29	250	108	35.93	\$946	\$142
PN3078SOR	30 x 78 x 29	250	115	40.42	\$1013	\$152
PN3084SOR	30 x 84 x 29	250	128	41.92	\$1081	\$163

PN3660SOR	36 x 60 x 29	250	107	28.44	\$996	\$150
PN3666SOR	36 x 66 x 29	250	113	29.19	\$1028	\$155
PN3672SOR	36 x 72 x 29	250	144	41.92	\$1142	\$172
PN3678SOR	36 x 78 x 29	250	129	44.91	\$1108	\$167
PN3684SOR	36 x 84 x 29	250	144	47.90	\$1149	\$173

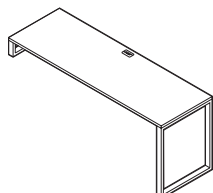

RIGHT

Overlapping Return w/Metal Leg and Spacer for 23"H Credenza

1" x 2" metal frame leg on **right**. One 5"H metal frame spacer with support channel(s). Overlaps 23"H credenza. Grommet in worksurface. Shipped in 3 cartons.

PN3060TSL	30 x 60 x 29	250	95	26.20	\$881	\$133
PN3066TSL	30 x 66 x 29	250	101	26.95	\$914	\$138
PN3072TSL	30 x 72 x 29	250	108	35.93	\$937	\$141
PN3078TSL	30 x 78 x 29	250	115	40.42	\$1004	\$151
PN3084TSL	30 x 84 x 29	250	128	41.92	\$1063	\$160

PN3660TSL	36 x 60 x 29	250	107	28.44	\$987	\$148
PN3666TSL	36 x 66 x 29	250	113	29.19	\$1019	\$153
PN3672TSL	36 x 72 x 29	250	144	41.92	\$1133	\$170
PN3678TSL	36 x 78 x 29	250	129	44.91	\$1094	\$165
PN3684TSL	36 x 84 x 29	250	144	47.90	\$1135	\$171

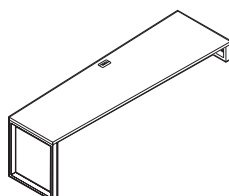

LEFT

Overlapping Wedge Return w/Metal Leg and Spacer for 23"H Credenza

1" x 2" metal open frame leg on **left**. One 5"H frame spacer with support channel(s). 30"D has 24"D leg and 30"D spacer. 36"D has 30"D leg and 36"D spacer. Overlaps 23"H credenza. Grommet in worksurface. Shipped in 3 cartons.

Required Specifications

Top finish
Leg finish

Optional Specifications

HP laminate
POG1, POG3 - additional grommet
PCSG - custom grommet
RSG - remove grommet

Accessories

Power block
Keyboard tray
Desktop screen
Keyboard tray mounting kit
Wire manager
Keyboard mechanism

OVERLAPPING RETURNS - METAL LEGS

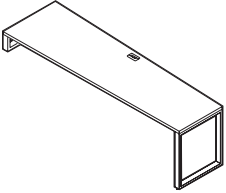

RIGHT

Overlapping Wedge Return w/Metal Leg and Spacer for 23”H Credenza*

MODEL#	DIMENSIONS D x W x H	FREIGHT CLASS	WT./LBS.	CUBIC FT.	LIST PRICE	HP ADD
PN3060TSR	30 x 60 x 29	250	95	26.20	\$881	\$133
PN3066TSR	30 x 66 x 29	250	101	26.95	\$914	\$138
PN3072TSR	30 x 72 x 29	250	108	35.93	\$937	\$141
PN3078TSR	30 x 78 x 29	250	115	40.42	\$1004	\$151
PN3084TSR	30 x 84 x 29	250	128	41.92	\$1063	\$160
PN3660TSR	36 x 60 x 29	250	107	28.44	\$987	\$148
PN3666TSR	36 x 66 x 29	250	113	29.19	\$1019	\$153
PN3672TSR	36 x 72 x 29	250	144	41.92	\$1133	\$170
PN3678TSR	36 x 78 x 29	250	129	44.91	\$1094	\$165
PN3684TSR	36 x 84 x 29	250	144	47.90	\$1135	\$171

1” x 2” metal frame leg on **right**. One 5”H frame spacer with support channel(s). 30”D has 24”D leg and 30”D spacer. 36”D has 30”D leg and 36”D spacer. Overlaps 23”H credenza. Grommet in worksurface. Shipped in 3 cartons.

BRIDGES FOR DESKS AND RETURNS WITH METAL LEGS

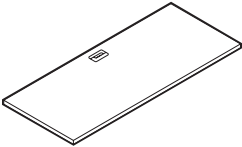

Flush Bridge for Metal Leg Configurations

PN2436BFM	24 x 36 x 1	70	31	2	\$240	\$52
PN2442BFM	24 x 42 x 1	70	40	2.50	\$245	\$54
PN2448BFM	24 x 48 x 1	85	44	3	\$257	\$56
PN2454BFM	24 x 54 x 1	70	51	3	\$350	\$76
PN3036BFM	30 x 36 x 1	70	44	2.50	\$243	\$53
PN3042BFM	30 x 42 x 1	70	50	3	\$254	\$55
PN3048BFM	30 x 48 x 1	70	55	3.50	\$268	\$58
PN3054BFM	30 x 54 x 1	70	62	3.50	\$371	\$81

Connects between any two: freestanding desk with metal legs, freestanding desk with bookshelf and metal leg, conference top for U configurations, 29”H credenza opening. Grommet in worksurface.

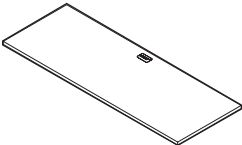

LEFT

Overlapping Bridge for Metal Leg Configurations

PN2460OBL	24 x 60 x 2	70	51	3	\$334	\$67
PN2466OBL	24 x 66 x 1	70	62	3.25	\$346	\$70
PN2472OBL	24 x 72 x 2	92.5	66	6.50	\$352	\$71
PN2478OBL	24 x 78 x 2	92.5	76	6.50	\$478	\$96
PN3060OBL	30 x 60 x 2	70	62	3.75	\$352	\$71
PN3066OBL	30 x 66 x 2	70	68	4	\$371	\$75
PN3072OBL	30 x 72 x 2	92.5	75	7	\$396	\$80
PN3078OBL	30 x 78 x 2	92.5	89	8.50	\$504	\$101

Connects freestanding desk with metal legs, freestanding desk with bookshelf and metal leg, conference top for U configurations flush on one end, and overlaps 27”H credenza opening on the other end. Includes 1” spacer. Grommet in worksurface.

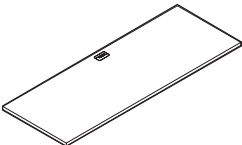

RIGHT

Overlapping Bridge for Metal Leg Configurations

PN2460OBR	24 x 60 x 2	70	51	3	\$334	\$67
PN2466OBR	24 x 66 x 2	70	62	3.25	\$346	\$70
PN2472OBR	24 x 72 x 2	92.5	66	6.50	\$352	\$71
PN2478OBR	24 x 78 x 2	92.5	76	6.50	\$478	\$96
PN3060OBR	30 x 60 x 2	70	62	3.75	\$352	\$71
PN3066OBR	30 x 66 x 2	70	68	4	\$371	\$75
PN3072OBR	30 x 72 x 2	92.5	75	7	\$396	\$80
PN3078OBR	30 x 78 x 2	92.5	89	8.50	\$504	\$101

Connects freestanding desk with metal legs, freestanding desk with bookshelf and metal leg, conference top for U configurations flush on one end, and overlaps 27”H credenza opening on the other end. Includes 1” spacer. Grommet in worksurface.

Required Specifications

Top finish
Leg finish*

Optional Specifications

HP laminate
POG1, POG3 - additional grommet
PCSG - custom grommet
RSG - remove grommet

Accessories

Power block
Keyboard tray
Desktop screen
Keyboard tray mounting kit
Wire manager
Keyboard mechanism

OVERLAPPING BRIDGES - METAL LEGS

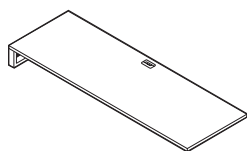

LEFT

Overlapping Bridge with Metal Spacer for 23"H Credenza

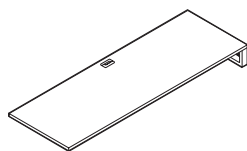

RIGHT

Overlapping Bridge with Metal Spacer for 23"H Credenza

MODEL#	DIMENSIONS	FREIGHT CLASS	WT/LBS.	CUBIC FT.	LIST PRICE	HP ADD
D x W x H						
PN2460OSL	24 x 60 x 6	125	63	9	\$553	\$120
PN2466OSL	24 x 66 x 6	125	74	9.50	\$581	\$126
PN2472OSL	24 x 72 x 6	150	78	16	\$600	\$130
PN2478OSL	24 x 78 x 6	150	88	16	\$679	\$147
PN3060OSL	30 x 60 x 6	125	75	10.50	\$597	\$130
PN3066OSL	30 x 66 x 6	125	81	11	\$618	\$134
PN3072OSL	30 x 72 x 6	150	88	19	\$651	\$141
PN3078OSL	30 x 78 x 6	150	102	20	\$709	\$154

One 5"H metal frame spacer with support channel(s). Connects flush on **right** side to freestanding desk with metal legs, freestanding desk with bookshelf and metal leg, or conference top for U configurations. Overlaps 23"H credenza opening on the **left**. Grommet in worksurface. Shipped in 2 cartons.

PN2460OSR	24 x 60 x 6	125	63	9	\$553	\$120
PN2466OSR	24 x 66 x 6	125	74	9.50	\$581	\$126
PN2472OSR	24 x 72 x 6	150	78	16	\$600	\$130
PN2478OSR	24 x 78 x 6	150	88	16	\$679	\$147
PN3060OSR	30 x 60 x 6	125	75	10.50	\$597	\$130
PN3066OSR	30 x 66 x 6	125	81	11	\$618	\$134
PN3072OSR	30 x 72 x 6	150	88	19	\$651	\$141
PN3078OSR	30 x 78 x 6	150	102	20	\$709	\$154

One 5"H metal frame spacer with support channel(s). Connects flush on **left** side to freestanding desk with metal legs, freestanding desk with bookshelf and metal leg, or conference top for U configurations. Overlaps 23"H credenza opening on the **right**. Grommet in worksurface. Shipped in 2 cartons.

RETURNS WITH BOOKSHELF

HP ADD GLASS SHELF

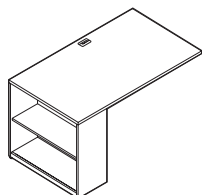

LEFT

Flush Return with Bookshelf*

PN2460FBL	24 x 60 x 29	150	86	20	\$653	\$98	\$56
PN2466FBL	24 x 66 x 29	150	97	20.50	\$744	\$112	\$56
PN2472FBL	24 x 72 x 29	250	101	27	\$767	\$115	\$56
PN2478FBL	24 x 78 x 29	150	111	27	\$814	\$123	\$56
PN2484FBL	24 x 84 x 29	250	106	29	\$859	\$129	\$56
PN3060FBL	30 x 60 x 29	150	102	25.50	\$692	\$104	\$71
PN3066FBL	30 x 66 x 29	150	108	26	\$786	\$118	\$71
PN3072FBL	30 x 72 x 29	250	115	32	\$812	\$122	\$71
PN3078FBL	30 x 78 x 29	250	129	35	\$869	\$131	\$71
PN3084FBL	30 x 84 x 29	250	135	36	\$952	\$143	\$71
PN3660FBL	36 x 60 x 29	150	117	29	\$763	\$115	\$86
PN3666FBL	36 x 66 x 29	150	123	29.50	\$933	\$140	\$86
PN3672FBL	36 x 72 x 29	250	132	38	\$999	\$150	\$86
PN3678FBL	36 x 78 x 29	250	139	40	\$1032	\$155	\$86
PN3684FBL	36 x 84 x 29	250	154	42	\$1097	\$165	\$86

12"D Bookcase with adjustable shelf on **left**. With support channel(s). Connects on **right** side to freestanding desk with metal legs or laminate end panels, 29"H freestanding returns, 29"H credenza opening. Laminate shelf is standard. Optional glass shelf. Grommet in worksurface. Shipped in 2 cartons.

Required Specifications

Top finish
Base finish*
Leg finish

Optional Specifications

HP laminate
POG1, POG3 - additional grommet
PCSG - custom grommet
RSG - remove grommet

Accessories

Power block
Keyboard tray
Desktop screen
Keyboard tray mounting kit
Wire manager
Keyboard mechanism

RETURNS WITH BOOKSHELF

MODEL#	DIMENSIONS D x W x H	FREIGHT CLASS	WT/LBS.	CUBIC FT.	LIST PRICE	HP ADD		
PN2460FBR	24 x 60 x 29	150	86	20	\$653	\$98	\$56	
PN2466FBR	24 x 66 x 29	150	97	20.50	\$744	\$112	\$56	
PN2472FBR	24 x 72 x 29	250	101	27	\$767	\$115	\$56	
PN2478FBR	24 x 78 x 29	150	111	27	\$814	\$123	\$56	
PN2484FBR	24 x 84 x 29	250	106	29	\$859	\$129	\$56	
PN3060FBR	30 x 60 x 29	150	102	25.50	\$692	\$104	\$71	
PN3066FBR	30 x 66 x 29	150	108	26	\$786	\$118	\$71	
PN3072FBR	30 x 72 x 29	250	115	32	\$812	\$122	\$71	
PN3078FBR	30 x 78 x 29	250	129	35	\$869	\$131	\$71	
PN3084FBR	30 x 84 x 29	250	135	36	\$952	\$143	\$71	
PN3660FBR	36 x 60 x 29	150	117	29	\$763	\$115	\$86	
PN3666FBR	36 x 66 x 29	150	123	29.50	\$933	\$140	\$86	
PN3672FBR	36 x 72 x 29	250	132	38	\$999	\$150	\$86	
PN3678FBR	36 x 78 x 29	250	139	40	\$1032	\$155	\$86	
PN3684FBR	36 x 84 x 29	250	154	42	\$1097	\$165	\$86	

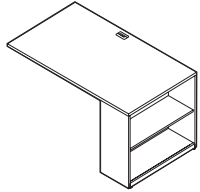

RIGHT

Flush Return with Bookshelf

12"D Bookcase with adjustable shelf on **right**. With support channel(s). Connects on **left** side to freestanding desk with metal legs or laminate end panels, 29"H freestanding returns, 29"H credenza opening. Laminate shelf is standard. Optional glass shelf. Grommet in worksurface. Shipped in 2 cartons.

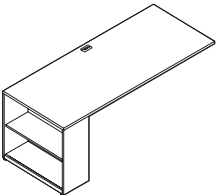

LEFT

Overlapping Return with Bookshelf

PN2484RBL	24 x 84 x 29	250	106	29	\$847	\$127	\$56	
PN2490RBL	24 x 90 x 29	250	110	30	\$942	\$142	\$56	
PN2496RBL	24 x 96 x 29	250	123	31	\$990	\$149	\$56	
PN3084RBL	30 x 84 x 29	250	135	36	\$881	\$133	\$71	
PN3090RBL	30 x 90 x 29	250	142	42	\$965	\$145	\$71	
PN3096RBL	30 x 96 x 29	250	146	38.50	\$1016	\$153	\$71	
PN3684RBL	36 x 84 x 29	250	198	62	\$934	\$141	\$86	
PN3690RBL	36 x 90 x 29	250	165	42.50	\$1091	\$164	\$86	
PN3696RBL	36 x 96 x 29	250	168	44	\$1120	\$168	\$86	

12"D Bookcase with adjustable shelf on **left**. With support channel(s). **Right** side overlaps 27"H credenza opening, 27"H freestanding return. Laminate shelf is standard. Optional glass shelf. Grommet in worksurface. Shipped in 2 cartons.

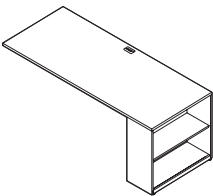

RIGHT

Overlapping Return with Bookshelf

PN2484RBR	24 x 84 x 29	250	106	29	\$847	\$127	\$56	
PN2490RBR	24 x 90 x 29	250	110	30	\$942	\$142	\$56	
PN2496RBR	24 x 96 x 29	250	123	31	\$990	\$149	\$56	
PN3084RBR	30 x 84 x 29	250	135	36	\$881	\$133	\$71	
PN3090RBR	30 x 90 x 29	250	142	42	\$965	\$145	\$71	
PN3096RBR	30 x 96 x 29	250	146	38.50	\$1016	\$153	\$71	
PN3684RBR	36 x 84 x 29	250	198	62	\$934	\$141	\$86	
PN3690RBR	36 x 90 x 29	250	165	42.50	\$1091	\$164	\$86	
PN3696RBR	36 x 96 x 29	250	168	44	\$1120	\$168	\$86	

12"D Bookcase with adjustable shelf on **right**. With support channel(s). **Left** side overlaps 27"H credenza opening, 27"H freestanding return. Laminate shelf is standard. Optional glass shelf. Grommet in worksurface. Shipped in 2 cartons.

Required Specifications

Top finish
Base finish

Optional Specifications

HP laminate
POG1, POG3 - additional grommet
PCSG - custom grommet
RSG - remove grommet

Accessories

Power block
Keyboard tray
Desktop screen
Keyboard tray mounting kit
Wire manager
Keyboard mechanism

CONFERENCE TOPS - FLUSH

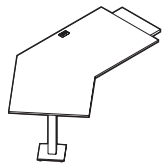

LEFT

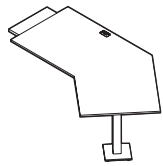

RIGHT

Offset Conference Top, Flush

MODEL#	DIMENSIONS D x W x H	FREIGHT CLASS	WT./LBS.	CUBIC FT.	LIST PRICE	HP ADD
PN2466CFL	47 x 66 x 29	150	135	25	\$826	\$106
PN2472CFL	47 x 72 x 29	150	140	27	\$831	\$107
PN3066CFL	47 x 66 x 29	150	142	25	\$841	\$107
PN3072CFL	47 x 72 x 29	92.5	52	5	\$878	\$101

PN2466CFR	47 x 66 x 29	150	135	25	\$826	\$106
PN2472CFR	47 x 72 x 29	150	140	27	\$831	\$107
PN3066CFR	47 x 66 x 29	150	142	25	\$841	\$107
PN3072CFR	47 x 72 x 29	92.5	52	5	\$878	\$101

Specify PNxxxxCFL for **LEFT** or PNxxxxCFR for **RIGHT**.

Standard with square monopost and base. Connects to freestanding desks with metal legs or laminate end panels, 29"H freestanding returns, 29"H credenza opening. Subtop finish is Granite with black edge. Grommet in worksurface. Shipped in 2 cartons.

Recommended Maximum Modesty Panel Size:

PN2466CFR/CFL: 36"W (PN3613DMF)	PN2472CFR/CFL: 42"W (PN4213DMF)
PN3066CFR/CFL: 36"W (PN3613DMF)	PN3072CFR/CFL: 42"W (PN4213DMF)

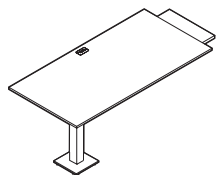

LEFT

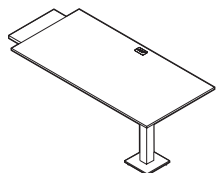

RIGHT

Conference Tops, Flush

PN2448DFL	24 x 48 x 29	125	55	8.50	\$536	\$76
PN2454DFL	24 x 54 x 29	125	67	11	\$584	\$83
PN2460DFL	24 x 60 x 29	125	70	11	\$610	\$87
PN3048DFL	30 x 48 x 29	150	59	5.50	\$572	\$82
PN3054DFL	30 x 54 x 29	125	76	12	\$587	\$84
PN3060DFL	30 x 60 x 29	125	76	6	\$595	\$85

PN2448DFR	24 x 48 x 29	125	55	8.50	\$536	\$76
PN2454DFR	24 x 54 x 29	125	67	11	\$584	\$83
PN2460DFR	24 x 60 x 29	125	70	11	\$610	\$87
PN3048DFR	30 x 48 x 29	150	59	5.50	\$572	\$82
PN3054DFR	30 x 54 x 29	125	76	12	\$587	\$84
PN3060DFR	30 x 60 x 29	125	76	6	\$595	\$85

Specify PNxxxxDFL for **LEFT** or PNxxxxDFR for **RIGHT**.

Standard with square monopost with base. Connects to Freestanding Desks with metal legs or laminate end panels, 29"H Freestanding Returns or 29"H credenza opening. Subtop finish is Granite with black edge. Grommet in worksurface. Shipped in 2 cartons.

Recommended Maximum Modesty Panel Size:

PN2448DFR/DFL: 30"W (PN3013DMF)	PN2454DFR/DFL: 30"W (PN3013DMF)	PN2460DFR/DFL: 36"W (PN3613DMF)
PN3048DFR/DFL: 30"W (PN3013DMF)	PN3054DFR/DFL: 30"W (PN3013DMF)	PN3060DFR/DFL: 36"W (PN3613DMF)

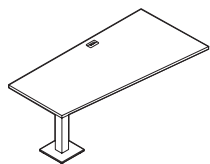

LEFT

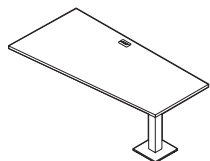

RIGHT

Wedge Shaped Flush Conference Top

PN3048TFL	30 x 48 x 29	150	59	11	\$572	\$82
PN3054TFL	30 x 54 x 29	125	76	12	\$587	\$84
PN3060TFL	30 x 60 x 29	125	81	12.50	\$595	\$85

PN3048TFR	30 x 48 x 29	150	59	11	\$572	\$82
PN3054TFR	30 x 54 x 29	125	76	12	\$587	\$84
PN3060TFR	30 x 60 x 29	125	81	12.50	\$595	\$85

Specify PNxxxxTFL for **LEFT** or PNxxxxTFR for **RIGHT**.

Standard with square monopost with base. 30"D at connecting end, 24"D at monopost end. Connects to Freestanding Desks with metal legs or laminate end panels, 29"H Freestanding Returns or 29"H credenza opening. Subtop finish is Granite with black edge. Grommet in worksurface. Shipped in 2 cartons.

Recommended Maximum Modesty Panel Size:

PN3048TFR/TFL: 30"W (PN3013DMF)	PN3054TFR/TFL: 30"W (PN3013DMF)
PN3060TFR/TFL: 36"W (PN3013DMF)	

Required Specifications

Top finish
Monopost finish

Optional Specifications

HP laminate
POG1, POG3 - additional grommet
PCSG - custom grommet
RSG - remove grommet

Accessories

Power block
Keyboard tray
Desktop screen
Keyboard tray mounting kit
Wire manager
Keyboard mechanism

CONFERENCE TOPS - OVERLAPPING

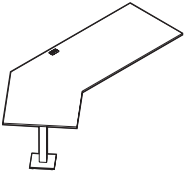

LEFT

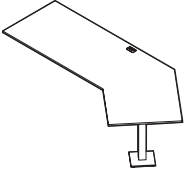

RIGHT

Offset Conference Top, Overlapping

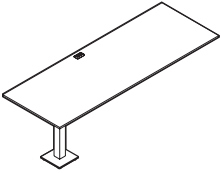

LEFT

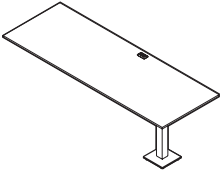

RIGHT

Conference Top, Overlapping

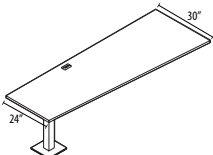

LEFT

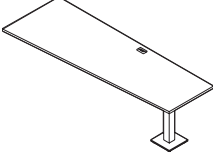

RIGHT

Wedge Shaped Overlapping Conference Top

MODEL#	DIMENSIONS D x W x H	FREIGHT CLASS	WT/LBS.	CUBIC FT.	LIST PRICE	HP ADD
PN2490COL	47 x 90 x 29	150	170	32	\$926	\$98
PN2496COL	47 x 96 x 29	150	172	34	\$939	\$98
PN3090COL	47 x 90 x 29	150	174	32	\$948	\$100
PN3096COL	47 x 96 x 29	100	58.50	6.50	\$958	\$105
PN2490COR	47 x 90 x 29	150	170	32	\$926	\$98
PN2496COR	47 x 96 x 29	150	172	33	\$939	\$98
PN3090COR	47 x 90 x 29	150	174	32	\$948	\$100
PN3096COR	47 x 96 x 29	100	58.50	6.50	\$958	\$105

Specify PNxxxxCOL for **LEFT** or PNxxxxCOR for **RIGHT**.

Standard with square monopost and base. Overlaps **27"H** credenza opening or **27"H** Freestanding Return. Subtop finish is Granite with black edge. Grommet in worksurface. 1" spacer included. Shipped in 2 cartons.

Recommended Maximum Modesty Panel Size:

PN2490COR/COL: 36"W (PN3613DMF)	PN2496COR/COL: 42"W (PN4213DMF)
PN3090COR/COL: 36"W (PN3613DMF)	PN3096COR/COL: 42"W (PN4213DMF)

PN2472DOL	24 x 72 x 29	150	81	19	\$669	\$87
PN2478DOL	24 x 78 x 29	250	85	23	\$719	\$88
PN2484DOL	24 x 84 x 29	150	90	20	\$790	\$88
PN3072DOL	30 x 72 x 29	150	94	19	\$725	\$89
PN3078DOL	30 x 78 x 29	150	101	23	\$739	\$90
PN3084DOL	30 x 84 x 29	92.5	44.50	4	\$794	\$96
PN2472DOR	24 x 72 x 29	150	81	19	\$669	\$87
PN2478DOR	24 x 78 x 29	250	85	23	\$719	\$88
PN2484DOR	24 x 84 x 29	150	90	20	\$790	\$88
PN3072DOR	30 x 72 x 29	150	94	9.50	\$725	\$89
PN3078DOR	30 x 78 x 29	150	101	23	\$739	\$90
PN3084DOR	30 x 84 x 29	92.5	44.50	4	\$794	\$96

Specify PNxxxxDOL for **LEFT** or PNxxxxDOR for **RIGHT**.

Standard with square monopost and base. Overlaps **27"H** credenza opening or **27"H** Freestanding Return. Subtop finish is Granite with black edge. Grommet in worksurface. 1" spacer included. Shipped in 2 cartons.

Recommended Maximum Modesty Panel Size:

PN2472DOR/DOL: 30"W (PN3013DMF)	PN2478DOR/DOL: 30"W (PN3013DMF)	PN2484DOR/DOL: 36"W (PN3613DMF)
PN3072DOR/DOL: 30"W (PN3013DMF)	PN3078DOR/DOL: 30"W (PN3013DMF)	PN3084DOR/DOL: 36"W (PN3613DMF)

PN3072TOL	30 x 72 x 29	150	94	19	\$725	\$98
PN3078TOL	30 x 78 x 29	150	101	23	\$739	\$100
PN3084TOL	30 x 84 x 29	150	114	23	\$794	\$108
PN3072TOR	30 x 72 x 29	150	94	19	\$725	\$98
PN3078TOR	30 x 78 x 29	150	101	23	\$739	\$100
PN3084TOR	30 x 84 x 29	150	114	23	\$794	\$108

Specify PNxxxxDOL for **LEFT** or PNxxxxTOR for **RIGHT**.

Standard with square monopost and base. 30"d at overlapping end, 24"d at monopost end. Overlaps **27"H** Credenza opening or **27"H** Freestanding Return. Grommet in worksurface. 1" spacer included. Shipped in 2 cartons.

Recommended Maximum Modesty Panel Size:

PN3072TOR/TOL: 30"W (PN3013DMF)	PN3078TOR/TOL: 30"W (PN3013DMF)	PN3084TOR/TOL: 36"W (PN3613DMF)
---------------------------------	---------------------------------	---------------------------------

Required Specifications

Top finish
Monopost finish

Optional Specifications

HP laminate
POG1, POG3 - additional grommet
PCSG - custom grommet
RSG - remove grommet

Accessories

Power block
Keyboard tray
Desktop screen
Keyboard tray mounting kit
Wire manager
Keyboard mechanism

CONFERENCE TOPS FOR U CONFIGURATIONS

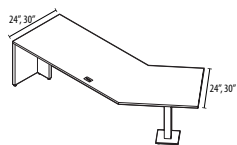

LEFT

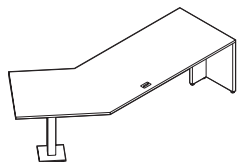

RIGHT

Offset Conference Top for U Configurations

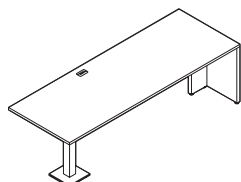

LEFT

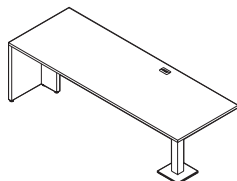

RIGHT

Conference Top for U Configurations

MODEL#	DIMENSIONS	FREIGHT CLASS	WT/LBS.	CUBIC FT.	LIST PRICE	HP ADD
D x W x H						
PN2490CUL	47 x 90 x 29	150	190	32	\$991	\$134
PN2496CUL	47 x 96 x 29	150	192	33	\$1003	\$136
PN3090CUL	47 x 90 x 29	125	194	32	\$1003	\$136
PN3096CUL	47 x 96 x 29	125	195	32	\$1015	\$137
PN2490CUR	47 x 90 x 29	150	190	32	\$991	\$134
PN2496CUR	47 x 96 x 29	150	192	33	\$1003	\$136
PN3090CUR	47 x 90 x 29	125	194	32	\$1003	\$136
PN3096CUR	47 x 96 x 29	125	195	32	\$1015	\$137

Specify PNxxxxCUL for **LEFT** or PNxxxxCUR for **RIGHT**.

Standard with T base with square monopost and base. End panel is 1" thick. 1.5" thick support gable extends 12" for end panel. Not freestanding, must be connected. Connects to bridges. Grommet in worksurface. Shipped in 2 cartons.

Recommended Maximum Modesty Panel Size:

PN2490CUR/CUL: 60"W (PN6013DMF)	PN2496CUR/CUL: 66"W (PN6613DMF)
PN3090CUR/CUL: 60"W (PN6013DMF)	PN3096CUR/CUL: 66"W (PN6613DMF)

PN2472DUL	24 x 72 x 29	150	105	18	\$798	\$108
PN2478DUL	24 x 78 x 29	150	108	19	\$885	\$120
PN2484DUL	24 x 84 x 29	150	110	20	\$966	\$131
PN3072DUL	30 x 72 x 29	125	114	19	\$852	\$115
PN3078DUL	30 x 78 x 29	150	121	22	\$915	\$124
PN3084DUL	30 x 84 x 29	150	134	23	\$1002	\$136
PN2472DUR	24 x 72 x 29	150	105	18	\$798	\$108
PN2478DUR	24 x 78 x 29	150	108	19	\$885	\$120
PN2484DUR	24 x 84 x 29	150	110	20	\$966	\$131
PN3072DUR	30 x 72 x 29	125	114	19	\$852	\$115
PN3078DUR	30 x 78 x 29	150	121	22	\$915	\$124
PN3084DUR	30 x 84 x 29	150	134	23	\$1002	\$136

Specify PNxxxxDUL for **LEFT** or PNxxxxDUR for **RIGHT**.

Standard with T base with square monopost and base. End panel is 1" thick. 1.5" thick support gable extends 12" for end panel. Not freestanding, must be connected. Connects to bridges. Grommet in worksurface. Shipped in 2 cartons.

Recommended Maximum Modesty Panel Size:

PN2472DUR/DUL: 48"W (PN4813DMF)	PN2478DUR/DUL: 54"W (PN5413DMF)	PN2484DUR/DUL: 60"W (PN6013DMF)
PN3072DUR/DUL: 48"W (PN4813DMF)	PN3078DUR/DUL: 54"W (PN5413DMF)	PN3084DUR/DUL: 60"W (PN6013DMF)

Required Specifications

Top finish
Base finish
Monopost finish

Optional Specifications

HP laminate
POG1, POG3 - additional grommet
PCSG - custom grommet
RSG - remove grommet

Accessories

Power block
Keyboard tray
Desktop screen
Keyboard tray mounting kit
Wire manager
Keyboard mechanism

DESKTOP AND MODESTY PANELS

Fabric Desktop/Modesty Panel

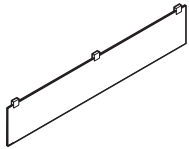

MODEL#	DIMENSIONS D x W x H	FREIGHT CLASS	WT/LBS.	CUBIC FT.	LIST PRICE	HP ADD
PN3013DMF	.37 x 30 x 13	250	3	1	1	\$329
					2	\$353
					3	\$372
					4	\$400
PN3613DMF	.37 x 36 x 13	250	3.60	1	1	\$347
					2	\$377
					3	\$400
					4	\$435
PN4213DMF	.37 x 42 x 13	150	4.20	1	1	\$366
					2	\$396
					3	\$419
					4	\$454
PN4813DMF	.37 x 48 x 13	250	4.80	1.50	1	\$374
					2	\$410
					3	\$438
					4	\$480
PN5413DMF	.37 x 54 x 13	250	5.40	1.50	1	\$391
					2	\$432
					3	\$465
					4	\$514
PN6013DMF	.37 x 60 x 13	150	6	1.50	1	\$415
					2	\$456
					3	\$489
					4	\$538
PN6613DMF	.37 x 66 x 13	150	6.60	1.50	1	\$486
					2	\$533
					3	\$571
					4	\$627
PN7213DMF	.37 x 72 x 13	150	7.20	1.75	1	\$518
					2	\$571
					3	\$613
					4	\$676
PN7813DMF	.37 x 78 x 13	150	7.80	1.75	1	\$523
					2	\$582
					3	\$629
					4	\$699

Panels up to 54" w have two clamps. Panels 60" and wider have three clamps. **When used as a modesty panel, specify a nominal size 6" shorter than worksurface size.**

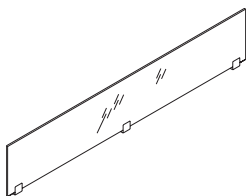

Frosted Glass Desktop/Modesty Panel

PN3013DG	.25 x 30 x 13	85	10	.75	\$262
PN3613DG	.25 x 36 x 13	70	14	.75	\$275
PN4213DG	.25 x 42 x 13	70	16	.75	\$299
PN4813DG	.25 x 48 x 13	70	20	1	\$311
PN5413DG	.25 x 54 x 13	70	22	1	\$349
PN6013DG	.25 x 60 x 13	70	24	1.50	\$409
PN6613DG	.25 x 66 x 13	70	26	1.50	\$422
PN7213DG	.25 x 72 x 13	70	28	1.50	\$434

Panels up to 54" w have two clamps. Panels 60" and wider have three clamps. When used as a modesty panel, specify a nominal size 6" shorter than worksurface size. If using modesty with overlapping worksurface or lower storage, contact customer care.

Required Specifications
Fabric (PNxxxDMF)

29" H CREDENZAS

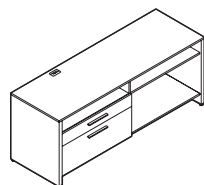

29" H Credenza - LEFT

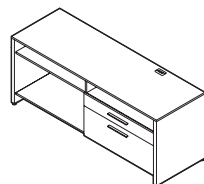

29" H Credenza - RIGHT

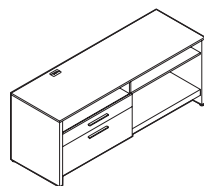

29" H Credenza w/Pull-Out Equipment Tray - LEFT

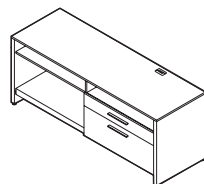

29" H Credenza w/Pull-Out Equipment Tray - RIGHT

MODEL#	DIMENSIONS	FREIGHT CLASS	WT/LBS.	CUBIC FT.	LIST PRICE	HP ADD
--------	------------	---------------	---------	-----------	------------	--------

D x W x H						
PN2984CRL	24 x 84 x 29	100	320	33.83	\$1420	\$164
PN2972CRL	24 x 72 x 29	92.5	290	29	\$1347	\$160
PN2966CRL	24 x 66 x 29	100	265	31	\$1332	\$162
PN2960CRL	24 x 60 x 29	92.5	242	24.17	\$1312	\$151

Standard with locking 34"W box and lateral file drawer on **left**. File bars included for front-to-back letter and legal filing capability. Lock on file drawer secures both drawers. Adjustable 6 position shelf. Wire management grommet on surface and internal pass-through behind equipment shelf. Connects to flush returns, flush bridges and flush conference tops. Shipped Fully Assembled.

PN2984CRR	24 x 84 x 29	100	320	33.83	\$1420	\$164
PN2972CRR	24 x 72 x 29	92.5	290	29	\$1347	\$160
PN2966CRR	24 x 66 x 29	100	265	31	\$1332	\$162
PN2960CRR	24 x 60 x 29	92.5	242	24.17	\$1312	\$151

Standard with locking 34"W box and lateral file drawer on **right**. File bars included for front-to-back letter and legal filing capability. Lock on file drawer secures both drawers. Adjustable 6 position shelf. Wire management grommet on surface and internal pass-through behind equipment shelf. Connects to flush returns, flush bridges and flush conference tops. Shipped Fully Assembled.

PN2984CPL	24 x 84 x 29	100	320	33.83	\$1604	\$172
PN2978CPL	24 x 78 x 29	100	310	36	\$1561	\$175
PN2972CPL	24 x 72 x 29	92.5	290	29	\$1522	\$170
PN2966CPL	24 x 66 x 29	100	270	31	\$1465	\$171
PN2960CPL	24 x 60 x 29	92.5	242	24.17	\$1427	\$156

Standard with locking 34"W box and lateral file drawer on **left**. File bars included for front-to-back letter and legal filing capability. Lock on file drawer secures both drawers. Adjustable 6 position shelf. Pull-out equipment shelf can support up to 80lbs. Wire management grommet on surface and internal pass-through behind equipment shelf. Connects to flush returns, flush bridges and flush conference tops. Shipped Fully Assembled.

PN2984CPR	24 x 84 x 29	100	320	33.83	\$1604	\$172
PN2978CPR	24 x 78 x 29	100	310	36	\$1561	\$175
PN2972CPR	24 x 72 x 29	92.5	290	29	\$1522	\$170
PN2966CPR	24 x 66 x 29	100	270	31	\$1465	\$171
PN2960CPR	24 x 60 x 29	92.5	242	24.17	\$1427	\$156

Standard with locking 34"W box and lateral file drawer on **right**. File bars included for front-to-back letter and legal filing capability. Lock on file drawer secures both drawers. Adjustable 6 position shelf. Pull-out equipment shelf can support up to 80lbs. Wire management grommet on surface and internal pass-through behind equipment shelf. Connects to flush returns, flush bridges and flush conference tops. Shipped Fully Assembled.

Required Specifications

- Top finish
- Base finish
- Drawer front finish

Optional Specifications

- HP laminate
- POG1, POG3 - additional grommet
- PCSG - custom grommet
- RSG - remove grommet

29" H CREDENZAS

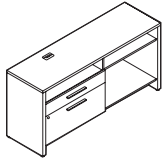

LEFT

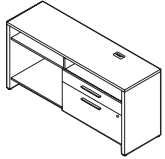

RIGHT

29" H Narrow Credenza**

MODEL#	DIMENSIONS D x W x H	FREIGHT CLASS	WT/LBS.	CUBIC FT.	LIST PRICE	HP ADD
PN2954NCL	20 x 54 x 29	92.5	250	22	\$1298	\$176
PN2960NCL	20 x 60 x 29	92.5	260	24	\$1315	\$178

PN2954NCR	20 x 54 x 29	92.5	250	22	\$1298	\$176
PN2960NCR	20 x 60 x 29	92.5	260	24	\$1315	\$178

Specify PNxxxxNCL for **LEFT** or PNxxxxNCR for **RIGHT**.

20"D. Standard with 30"W box and lateral file drawer. Front-to-back letter and legal filing capability. Lock on file drawer secures both drawers. Adjustable 6 position shelf. Wire management grommet on surface and internal pass-through behind lower shelf. Connects to flush returns, flush bridges and flush conference tops. File bars included. Shipped Fully Assembled.

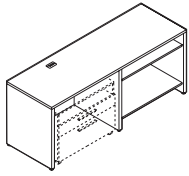

LEFT

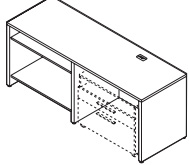

RIGHT

29" H Credenza for Mobile Lateral File*

PN2966MCL	24 x 66 x 29	125	244	31	\$1038	\$141
PN2972MCL	24 x 72 x 29	125	252	34	\$1061	\$144
PN2978MCL	24 x 78 x 29	125	260	36	\$1096	\$148
PN2984MCL	24 x 84 x 29	125	268	39.50	\$1145	\$155

PN2966MCR	24 x 66 x 29	125	244	31	\$1038	\$141
PN2972MCR	24 x 72 x 29	125	252	34	\$1061	\$144
PN2978MCR	24 x 78 x 29	125	260	36	\$1096	\$148
PN2984MCR	24 x 84 x 29	125	268	39	\$1145	\$155

Specify PNxxxxMCL for **LEFT** or PNxxxxMCR for **RIGHT**.

Standard with 42" w space for lateral file. Adjustable 6 position shelf. Wire management grommet on surface and internal pass-through behind lower shelf. Connects to flush returns, flush bridges and flush conference tops. Accepts all mobile lateral file units. Shipped Fully Assembled.

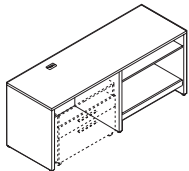

LEFT

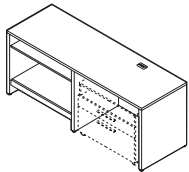

RIGHT

29" H Credenza for Mobile Lateral File w/Pull-Out Equipment Tray*

PN2966MPL	24 x 66 x 29	100	250	31	\$1180	\$160
PN2972MPL	24 x 72 x 29	125	258	34	\$1215	\$164
PN2978MPL	24 x 78 x 29	125	268	36	\$1252	\$169
PN2984MPL	24 x 84 x 29	125	274	39.50	\$1293	\$175

PN2966MPR	24 x 66 x 29	100	250	31	\$1180	\$160
PN2972MPR	24 x 72 x 29	125	258	34	\$1215	\$164
PN2978MPR	24 x 78 x 29	125	268	36	\$1252	\$169
PN2984MPR	24 x 84 x 29	125	274	39.50	\$1293	\$175

Specify PNxxxxMPL for **LEFT** or PNxxxxMPR for **RIGHT**.

Standard with 42" w space for lateral file, adjustable 6 position shelf, and pull-out equipment shelf that can support up to 80lbs. Grommet in worksurface and internal pass-through behind equipment shelf. Connects to flush returns, flush bridges and flush conference tops. Accepts all mobile lateral file units. Shipped Fully Assembled.

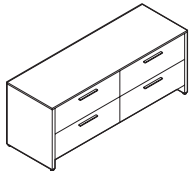

29" H Lateral File Credenza**

PN2972LF	24 x 72 x 29	92.5	290	29	\$1602	\$204
----------	--------------	------	-----	----	---------------	--------------

Standard with four lateral file drawers. File bars included for front-to-back letter and legal filing capability. Lock on lower drawer secures both drawers. Anti-tip mechanism. Shipped Fully Assembled.

Required Specifications

- Top finish
- Base finish
- Drawer front finish**

Optional Specifications

- HP laminate
- POG1, POG3 - additional grommet*
- PCSG - custom grommet *
- RSG - remove grommet*

29"H CREDENZAS

MODEL# DIMENSIONS FREIGHT CLASS WT/LBS. CUBIC FT. LIST PRICE HP ADD

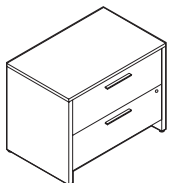

29"H Single Lateral File Credenza*

D x W x H							
PN2937LFS	24 x 37 x 29	100	155	18	\$1085	\$147	

Standard with two lateral file drawers. File bars included for front-to-back letter and legal filing capability. Lock on lower drawer secures both drawers. Anti-tip mechanism. Shipped Fully Assembled.

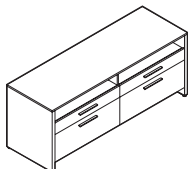

29"H Double Credenza*

PN2972CRD	24 x 72 x 29	92.5	290	29	\$1541	\$190	
-----------	--------------	------	-----	----	--------	-------	--

Standard with 34" w box and lateral file drawer on each side. File bars included for front-to-back letter and legal filing capability. Lock on file drawer secures both drawers. Shipped Fully Assembled.

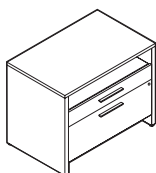

29"H Single Credenza*

PN2937CRS	24 x 37 x 29	100	145	18	\$1085	\$147	
-----------	--------------	-----	-----	----	--------	-------	--

Standard with 34" w box and lateral file drawer. File bars included for front-to-back letter and legal filing capability. Lock on file drawer secures both drawers. Shipped Fully Assembled.

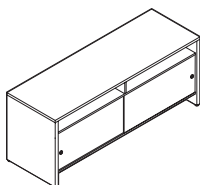

29"H Credenza w/Sliding Laminate Doors*

PN2960CLS	24 x 60 x 29	100	265	28.25	\$1257	\$170	
PN2966CLS	24 x 66 x 29	100	277	31	\$1294	\$175	
PN2972CLS	24 x 72 x 29	100	289	34	\$1317	\$178	
PN2978CLS	24 x 78 x 29	100	301	36	\$1382	\$187	
PN2984CLS	24 x 84 x 29	100	337	39.50	\$1438	\$194	

Standard with sliding laminate doors in upper plastic track. Recessed brushed aluminum finger pulls. No lock. Shipped Fully Assembled.

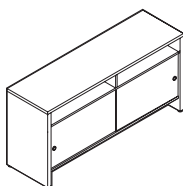

29"H Narrow Credenza w/Sliding Laminate Doors*

PN2954NLS	20 x 54 x 29	92.5	235	22	\$1215	\$164	
PN2960NLS	20 x 60 x 29	92.5	245	24	\$1237	\$167	

20"D. Standard with sliding laminate doors in upper plastic track. Recessed brushed aluminum finger pulls. No lock. Shipped Fully Assembled.

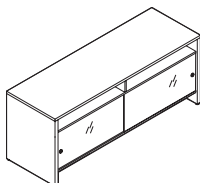

29"H Credenza w/Sliding Glass Doors

PN2960CGS	24 x 60 x 29	100	265	28.25	\$1586	\$215	
PN2966CGS	24 x 66 x 29	100	277	31	\$1646	\$223	
PN2972CGS	24 x 72 x 29	100	289	34	\$1755	\$237	
PN2978CGS	24 x 78 x 29	100	301	36	\$1841	\$249	
PN2984CGS	24 x 84 x 29	100	337	39.50	\$1940	\$262	

Standard with sliding glass doors in upper aluminum track. Satin etched 6mm glass. Brushed aluminum finger pulls. No lock. Shipped Fully Assembled.

Required Specifications

Top finish
Base finish
Drawer front finish*

Optional Specifications

HP laminate
POG1, POG3 - additional grommet
PCSG - custom grommet
RSG - remove grommet

29" H CREDENZAS

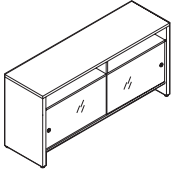

29" H Narrow Credenza w/Sliding Glass Doors

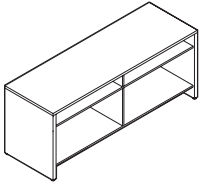

29" H Open Credenza

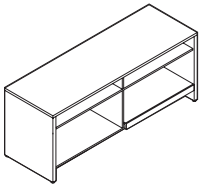

LEFT

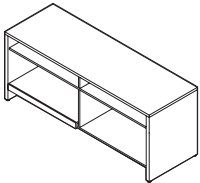

RIGHT

29" H Open Credenza w/Pull-Out Equipment Tray

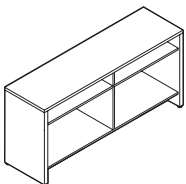

29" H Narrow Open Credenza

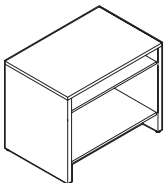

29" H Single Open Credenza

MODEL#	DIMENSIONS	FREIGHT CLASS	WT/LBS.	CUBIC FT.	LIST PRICE	HP ADD
--------	------------	---------------	---------	-----------	------------	--------

D x W x H

PN2954NGS	20 x 54 x 29	92.5	235	22	\$1530	\$207
PN2960NGS	20 x 60 x 29	92.5	245	24	\$1578	\$213

20"D. Standard with sliding glass doors in upper aluminum track. Satin etched 6mm glass. Brushed aluminum finger pulls. No lock. Shipped Fully Assembled.

PN2960CO	24 x 60 x 29	92.5	296	28.25	\$1057	\$143
PN2966CO	24 x 66 x 29	100	306	31	\$1094	\$148
PN2972CO	24 x 72 x 29	100	316	34	\$1119	\$152
PN2978CO	24 x 78 x 29	100	326	36	\$1184	\$160
PN2984CO	24 x 84 x 29	100	336	39.50	\$1242	\$168

Open storage with adjustable 6 position upper shelves with pass-throughs at back of lower shelves. Connects to flush returns, flush bridges and flush conference tops. Shipped Fully Assembled.

PN2960POL	24 x 60 x 29	92.5	302	28.25	\$1273	\$172
PN2966POL	24 x 66 x 29	92.5	312	31	\$1311	\$177
PN2972POL	24 x 72 x 29	100	322	34	\$1336	\$181
PN2978POL	24 x 78 x 29	100	332	36	\$1396	\$189
PN2984POL	24 x 84 x 29	100	342	39.50	\$1420	\$192

PN2960POR	24 x 60 x 29	92.5	302	28.25	\$1273	\$172
PN2966POR	24 x 66 x 29	92.5	312	31	\$1311	\$177
PN2972POR	24 x 72 x 29	100	322	34	\$1336	\$181
PN2978POR	24 x 78 x 29	100	332	36	\$1396	\$189
PN2984POR	24 x 84 x 29	100	342	39.50	\$1420	\$192

Specify PNxxxxPOL for **LEFT** or PNxxxxPOR for **RIGHT**.

Open storage with adjustable 6 position upper shelves. Pass-throughs at back of lower shelves. Pull-out equipment tray can support up to 80lbs. Connects to flush returns, flush bridges and flush conference tops. Shipped Fully Assembled.

PN2954NO	20 x 54 x 29	100	215	22	\$1010	\$137
PN2960NO	20 x 60 x 29	100	215	22	\$1036	\$140

20"D open storage. Adjustable 6 position upper shelves with pass-throughs at back of lower shelves. Connects to flush returns, flush bridges and flush conference tops. Shipped Fully Assembled.

PN2924CO	24 x 24 x 29	85	148	12	\$672	\$91
PN2930CO	24 x 30 x 29	92.5	153	15	\$679	\$92
PN2936CO	24 x 36 x 29	100	158	18	\$710	\$96

Open storage with adjustable 6 position upper shelf with pass-through at back of lower shelf. Connects to flush returns, flush bridges and flush conference tops. Shipped Fully Assembled.

Required Specifications

Top finish
Base finish

Optional Specifications

HP laminate
Grommet

Accessories

Power block
Wire manager

29" H CREDENZAS

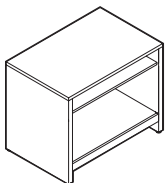

29" H Single Open Credenza w/Pull-Out Equipment Tray

MODEL#	DIMENSIONS D x W x H	FREIGHT CLASS	WT/LBS.	CUBIC FT.	LIST PRICE	HP ADD
PN2924PO	24 x 24 x 29	85	154	12	\$815	\$110
PN2930PO	24 x 30 x 29	92.5	159	15	\$822	\$111
PN2936PO	24 x 36 x 29	100	164	18	\$853	\$116

Open storage with adjustable 6 position upper shelf. Pass-through at back of lower shelf. Pull-out equipment tray can support up to 80lbs. Connects to flush returns, flush bridges and flush conference tops. Shipped Fully Assembled.

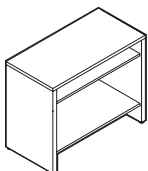

29" H Single Narrow Open Credenza

PN2924NO	20 x 24 x 29	85	148	10	\$640	\$87
PN2930NO	20 x 30 x 29	92.5	153	13	\$647	\$88
PN2936NO	20 x 36 x 29	92.5	158	15	\$678	\$92

20"D open storage. Adjustable 6 position upper shelf with pass-through at back of lower shelf. Connects to flush returns, flush bridges and flush conference tops. Shipped Fully Assembled.

27" H CREDENZAS

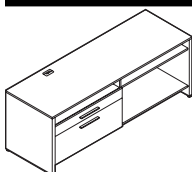

27" H Credenza - LEFT *

PN2760CRL	24 x 60 x 27	92.5	241	22.50	\$1299	\$146
PN2766CRL	24 x 66 x 27	100	262	29	\$1319	\$154
PN2772CRL	24 x 72 x 27	92.5	290	27	\$1332	\$154
PN2778CRL	24 x 78 x 27	100	290	34	\$1373	\$161
PN2784CRL	24 x 84 x 27	92.5	335	31.50	\$1407	\$159

Standard with locking 34"W box and lateral file drawer on **left**. File bars included for front-to-back letter and legal filing capability. Lock on file drawer secures both drawers. Adjustable 6 position shelf. Wire management grommet on surface and internal pass-through behind equipment shelf. Can go under Desks, Flush Return or **29" H** Freestanding Returns. Supports Overlapping Return/Overlapping Bridges/Overlapping Conference Top. Shipped Fully Assembled.

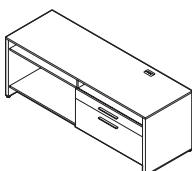

27" H Credenza - RIGHT *

PN2760CRR	24 x 60 x 27	92.5	241	22.50	\$1299	\$146
PN2766CRR	24 x 66 x 27	100	262	29	\$1319	\$154
PN2772CRR	24 x 72 x 27	92.5	290	27	\$1332	\$154
PN2778CRR	24 x 78 x 27	100	290	34	\$1373	\$161
PN2784CRR	24 x 84 x 27	92.5	335	31.50	\$1407	\$159

Standard with locking 34"W box and lateral file drawer on **right**. File bars included for front-to-back letter and legal filing capability. Lock on file drawer secures both drawers. Adjustable 6 position shelf. Wire management grommet on surface and internal pass-through behind equipment shelf. Can go under Desks, Flush Return or **29" H** Freestanding Returns. Supports Overlapping Return/Overlapping Bridges/Overlapping Conference Top. Shipped Fully Assembled.

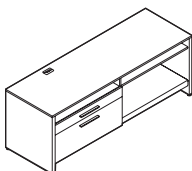

27" H Credenza w/Pull-Out Equipment Tray - LEFT*

PN2760CPL	24 x 60 x 27	92.5	241	22.50	\$1414	\$152
PN2766CPL	24 x 66 x 27	100	267	29	\$1452	\$163
PN2772CPL	24 x 72 x 27	92.5	290	27	\$1510	\$165
PN2778CPL	24 x 78 x 27	100	300	34	\$1548	\$172
PN2784CPL	24 x 84 x 27	92.5	335	31.50	\$1591	\$173

Standard with locking 34"W box and lateral file drawer on **left**. File bars included for front-to-back letter and legal filing capability. Lock on file drawer secures both drawers. Adjustable 6 position shelf. Pull-out equipment tray can support up to 80 lbs. Wire management grommet on surface and internal pass-through behind equipment shelf. Can go under Desks, Flush Return or **29" H** Freestanding Returns. Supports Overlapping Return/Overlapping Bridges/Overlapping Conference Top. Shipped Fully Assembled.

Required Specifications

Top finish
Base finish
Drawer/door front finish*

Optional Specifications

HP laminate
Grommet

Accessories

Power block
Wire manager

27" H CREDENZAS

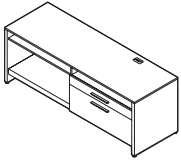

27" H Credenza w/Pull-Out Equipment Tray - RIGHT*

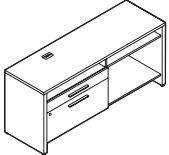

LEFT

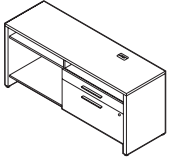

RIGHT

27" H Narrow Credenza

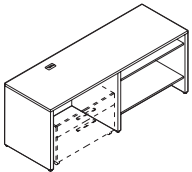

LEFT

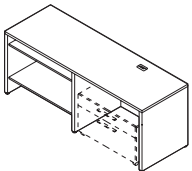

RIGHT

27" H Credenza for Mobile Lateral File

MODEL#	DIMENSIONS	FREIGHT CLASS	WT/LBS.	CUBIC FT.	LIST PRICE	HP ADD
--------	------------	---------------	---------	-----------	------------	--------

D x W x H

PN2760CPR	24 x 60 x 27	92.5	241	22.50	\$1414	\$152
PN2766CPR	24 x 66 x 27	100	267	29	\$1452	\$163
PN2772CPR	24 x 72 x 27	92.5	290	27	\$1510	\$165
PN2778CPR	24 x 78 x 27	100	300	34	\$1548	\$172
PN2784CPR	24 x 84 x 27	92.5	335	31.50	\$1591	\$173

Standard with locking 34"W box and lateral file drawer on **right**. File bars included for front-to-back letter and legal filing capability. Lock on file drawer secures both drawers. Adjustable 6 position shelf. Pull-out equipment tray can support up to 80 lbs. Wire management grommet on surface and internal pass-through behind equipment shelf. Can go under Desks, Flush Return or **29" H** Freestanding Returns. Supports Overlapping Return/Overlapping Bridges/Overlapping Conference Top. Shipped Fully Assembled.

PN2754NCL	20 x 54 x 27	92.5	250	22	\$1263	\$171
PN2760NCL	20 x 60 x 27	92.5	260	24	\$1280	\$173

PN2754NCR	20 x 54 x 27	92.5	250	22	\$1263	\$171
PN2760NCR	20 x 60 x 27	92.5	260	24	\$1280	\$173

Specify PNxxxxNCL for **LEFT** or PNxxxxNCR for **RIGHT**.

20"D. Standard with 30"W box and lateral file drawer. Front-to-back letter and legal filing capability. Lock on file drawer secures both drawers. Adjustable 6 position shelf. Wire management grommet on surface and internal pass-through at back of lower shelf. Can go under desks, flush returns or 29"H freestanding returns. Supports Overlapping Return/Overlapping Bridges/Overlapping Conference Top. File bars included. Shipped Fully Assembled.

PN2766MCL	24 x 66 x 27	100	244	29	\$1025	\$139
PN2772MCL	24 x 72 x 27	125	252	31.75	\$1048	\$142
PN2778MCL	24 x 78 x 27	125	260	34	\$1081	\$147
PN2784MCL	24 x 84 x 27	125	268	37	\$1132	\$153

PN2766MCR	24 x 66 x 27	100	244	29	\$1025	\$139
PN2772MCR	24 x 72 x 27	125	252	31.75	\$1048	\$142
PN2778MCR	24 x 78 x 27	125	260	34	\$1083	\$147
PN2784MCR	24 x 84 x 27	125	268	37	\$1132	\$153

Specify PNxxxxMCL for **LEFT** or PNxxxxMCR for **RIGHT**.

Standard with 42"W space for lateral file. Adjustable 6 position shelf. Wire management grommet on surface and internal pass-through at back of lower shelf. Can go under desks, flush returns or 29"H freestanding returns. Supports Overlapping Return/Overlapping Bridges/Overlapping Conference Top. Accepts mobile lateral file units: PN21MLSF and PN22MLBF with and without cushions, and PN26MLSFB without cushions. Shipped Fully Assembled.

Required Specifications

Top finish
Base finish
Drawer/door front finish*

Optional Specifications

HP laminate
Grommet
RSG - remove grommet

Accessories

Power block
Wire manager

27" H CREDENZAS

MODEL#	DIMENSIONS	FREIGHT CLASS	WT/LBS.	CUBIC FT.	LIST PRICE	HP ADD
--------	------------	---------------	---------	-----------	------------	--------

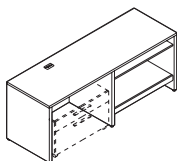

LEFT

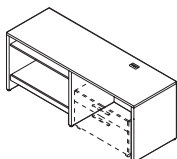

RIGHT

27" H Credenza for Mobile Lateral File w/Pull-Out Equipment Tray

	D x W x H					
PN2766MPL	24 x 66 x 27	100	250	29	\$1167	\$158
PN2772MPL	24 x 72 x 27	100	258	31.75	\$1202	\$163
PN2778MPL	24 x 78 x 27	125	268	34	\$1225	\$168
PN2784MPL	24 x 84 x 27	125	274	37	\$1262	\$173
PN2766MPR	24 x 66 x 27	100	250	29	\$1167	\$158
PN2772MPR	24 x 72 x 27	100	258	31.75	\$1202	\$163
PN2778MPR	24 x 78 x 27	125	268	34	\$1239	\$168
PN2784MPR	24 x 84 x 27	125	274	37	\$1280	\$173

Specify PNxxxxMPL for **LEFT** or PNxxxxMPR for **RIGHT**.

Standard with 42"W space for lateral file, adjustable 6 position shelf, and pull-out equipment shelf that can support up to 80lbs. Wire management grommet in surface and internal pass-through at back of pull-out equipment shelf. Can go under desk, flush return, or 29"H freestanding returns. Supports overlapping return, overlapping bridge, overlapping conference top. Accepts mobile lateral file units: PN21MLSF and PN22MLBF with and without cushions, and PN26MLSBF without cushions. Shipped Fully Assembled.

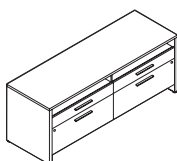

27" H Double Credenza*

PN2772CRD	24 x 72 x 27	100	290	31.75	\$1512	\$190
-----------	--------------	-----	-----	-------	---------------	--------------

Standard with locking 34"W box and lateral file drawer on each side. File bars included for front-to-back letter and legal filing capability. Lock on file drawer secures both drawers. Shipped Fully Assembled.

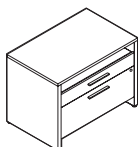

27" H Single Credenza*

PN2737CRS	24 x 37 x 27	100	145	18	\$1055	\$143
-----------	--------------	-----	-----	----	---------------	--------------

Standard with 34"W box and lateral file drawer. Lock on file drawer secures both drawers. File bars included for front-to-back letter and legal filing capability. Shipped Fully Assembled.

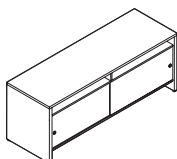

27" H Credenza w/Sliding Laminate Doors*

PN2760CLS	24 x 60 x 27	92.5	265	26.50	\$1244	\$168
PN2766CLS	24 x 66 x 27	100	277	29	\$1281	\$173
PN2772CLS	24 x 72 x 27	100	289	31.75	\$1304	\$177
PN2778CLS	24 x 78 x 27	100	301	34	\$1369	\$185
PN2784CLS	24 x 84 x 27	100	337	37	\$1425	\$193

Standard with sliding laminate doors in upper plastic track. Recessed brushed aluminum finger pulls. No lock. Shipped Fully Assembled.

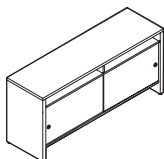

27" H Narrow Credenza w/Sliding Laminate Doors*

PN2754NLS	20 x 54 x 27	92.5	235	21	\$1202	\$163
PN2760NLS	20 x 60 x 27	92.5	245	22	\$1224	\$166

20"D. Standard with sliding laminate doors in upper plastic track. Recessed brushed aluminum finger pulls. No lock. Shipped Fully Assembled.

Required Specifications

Top finish
Base finish
Drawer/door front finish*

Optional Specifications

HP laminate
Grommet

Accessories

Power block
Wire manager

27"H CREDENZAS

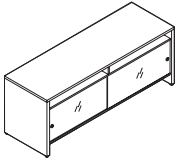

27"H Credenza w/Sliding Glass Doors

MODEL#	DIMENSIONS D x W x H	FREIGHT CLASS	WT/LBS.	CUBIC FT.	LIST PRICE	HP ADD
PN2760CGS	24 x 60 x 27	92.5	265	26.50	\$1572	\$213
PN2766CGS	24 x 66 x 27	100	277	29	\$1632	\$221
PN2772CGS	24 x 72 x 27	100	289	31.75	\$1750	\$237
PN2778CGS	24 x 78 x 27	100	301	34	\$1826	\$247
PN2784CGS	24 x 84 x 27	100	337	37	\$1926	\$260

Standard with sliding glass doors in upper aluminum track. Satin etched 6mm glass. Brushed aluminum finger pulls. No lock. Shipped Fully Assembled.

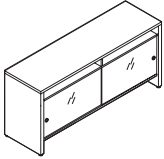

27"H Narrow Credenza w/Sliding Glass Doors

PN2754NGS	20 x 54 x 27	92.5	235	21	\$1516	\$205
PN2760NGS	20 x 60 x 27	92.5	245	22	\$1564	\$212

20"D. Standard with sliding glass doors in upper aluminum track. Satin etched 6mm glass. Brushed aluminum finger pulls. No lock. Shipped Fully Assembled.

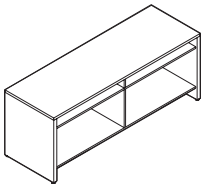

27"H Open Credenza

PN2760CO	24 x 60 x 27	92.5	296	26.50	\$1057	\$143
PN2766CO	24 x 66 x 27	92.5	306	29	\$1094	\$148
PN2772CO	24 x 72 x 27	100	316	31.75	\$1119	\$152
PN2778CO	24 x 78 x 27	100	326	34	\$1184	\$160
PN2784CO	24 x 84 x 27	100	336	37	\$1242	\$168

Open storage with adjustable 6 position upper shelves with pass-throughs at back of lower shelves. Supports Overlapping Return/Overlapping Bridges/Overlapping Conference Top. Shipped Fully Assembled.

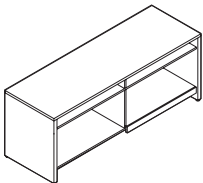

LEFT

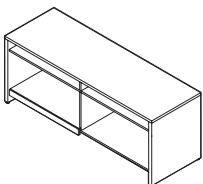

RIGHT

27"H Open Credenza w/Pull-Out Equipment Tray

PN2760POL	24 x 60 x 27	92.5	302	26.50	\$1260	\$170
PN2766POL	24 x 66 x 27	92.5	312	29	\$1298	\$176
PN2772POL	24 x 72 x 27	92.5	322	31.75	\$1323	\$179
PN2778POL	24 x 78 x 27	100	332	34	\$1384	\$187
PN2784POL	24 x 84 x 27	100	342	37	\$1407	\$190

PN2760POR	24 x 60 x 27	92.5	302	26.50	\$1260	\$170
PN2766POR	24 x 66 x 27	92.5	312	29	\$1298	\$176
PN2772POR	24 x 72 x 27	92.5	322	31.75	\$1323	\$179
PN2778POR	24 x 78 x 27	100	332	34	\$1384	\$187
PN2784POR	24 x 84 x 27	100	342	37	\$1407	\$190

Specify PNxxxxPOL for **LEFT** or PNxxxxPOR for **RIGHT**.

Open storage with adjustable 6 position upper shelves with pass-throughs at back of lower shelves, and pull-out equipment tray that can support up to 80lbs. Supports Overlapping Return/Overlapping Bridges/Overlapping Conference Top. Shipped Fully Assembled.

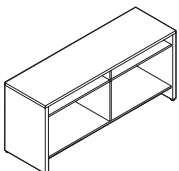

27"H Narrow Open Credenza

PN2754NO	20 x 54 x 27	92.5	215	21	\$1010	\$137
PN2760NO	20 x 60 x 27	92.5	225	22	\$1036	\$140

20"D open storage. Adjustable 6 position upper shelves with pass-throughs at back of lower shelves. Supports Overlapping Return/Overlapping Bridges/Overlapping Conference Top. Shipped Fully Assembled.

Required Specifications

Top finish
Base finish

Optional Specifications

HP laminate
Grommet

Accessories

Power block

27" H CREDENZAS

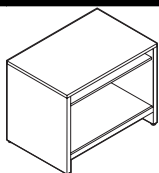

27" H Single Open Credenza

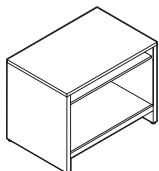

27" H Single Open Credenza w/Pull-Out Equipment Tray

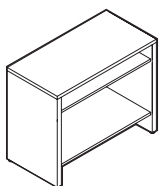

27" H Single Narrow Open Credenza

MODEL#	DIMENSIONS D x W x H	FREIGHT CLASS	WT/LBS.	CUBIC FT.	LIST PRICE	HP ADD
PN2724CO	24 x 24 x 27	85	148	11	\$659	\$89
PN2730CO	24 x 30 x 27	92.5	153	14	\$666	\$90
PN2736CO	24 x 36 x 27	100	158	16	\$697	\$95

Open storage with adjustable 6 position upper shelf with pass-through at back of lower shelf. Supports Overlapping Return/Overlapping Bridges/Overlapping Conference Top. Shipped Fully Assembled.

PN2724PO	24 x 24 x 27	85	154	11	\$802	\$109
PN2730PO	24 x 30 x 27	92.5	159	14	\$809	\$110
PN2736PO	24 x 36 x 27	92.5	164	16	\$840	\$114

Open storage with adjustable 6 position upper shelf with pass-through at back of lower shelf, and pull-out equipment tray that can support up to 80lbs. Supports Overlapping Return/Overlapping Bridges/Overlapping Conference Top. Shipped Fully Assembled.

PN2724NO	20 x 24 x 27	85	148	10	\$627	\$85
PN2730NO	20 x 30 x 27	85	153	12	\$634	\$86
PN2736NO	20 x 36 x 27	92.5	158	14	\$665	\$90

20"D open storage. Adjustable 6 position upper shelf with pass-through at back of lower shelf. Supports Overlapping Return/Overlapping Bridges/Overlapping Conference Top. Shipped Fully Assembled.

23" H CREDENZAS

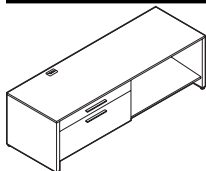

LEFT

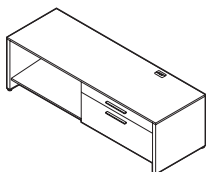

RIGHT

23" H Credenza*

PN2360CRL	24 x 60 x 23	100	190	19.17	\$1083	\$134
PN2366CRL	24 x 66 x 23	100	227	25	\$1107	\$141
PN2372CRL	24 x 72 x 23	100	228	23	\$1125	\$139
PN2378CRL	24 x 78 x 23	100	248	30	\$1150	\$145
PN2384CRL	24 x 84 x 23	100	266	26.83	\$1172	\$145

PN2360CRR	24 x 60 x 23	100	190	19.17	\$1083	\$134
PN2366CRR	24 x 66 x 23	100	227	25	\$1107	\$141
PN2372CRR	24 x 72 x 23	100	228	23	\$1125	\$139
PN2378CRR	24 x 78 x 23	100	248	30	\$1150	\$145
PN2384CRR	24 x 84 x 23	100	266	26.83	\$1172	\$145

Standard with 34"W box and lateral file drawer. File bars included for front-to-back letter and legal filing capability. Lock on file drawer secures both drawers. Wire management grommet on surface and internal pass-through at back of lower shelf. Supports Overlapping Return with metal leg and spacer for 23"H credenza, Overlapping Wedge Shaped Return with metal leg and spacer for 23"H credenza, and Overlapping Bridges with metal spacer for 23"H credenza. Shipped Fully Assembled.

Required Specifications

Top finish
Base finish
Drawer front finish*

Optional Specifications

HP laminate
Grommet
RSG - remove grommet*

Accessories

Cushion*

23" H CREDENZAS

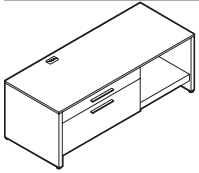

LEFT

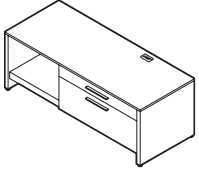

RIGHT

23" H Credenza w/Pull-Out Equipment Tray - RIGHT*

MODEL#	DIMENSIONS D x W x H	FREIGHT CLASS	WT/LBS.	CUBIC FT.	LIST PRICE	HP ADD
PN2360CPL	24 x 60 x 23	100	190	19.17	\$1228	\$142
PN2366CPL	24 x 66 x 23	100	233	25	\$1268	\$150
PN2372CPL	24 x 72 x 23	100	228	23	\$1310	\$148
PN2378CPL	24 x 78 x 23	100	254	30	\$1340	\$154
PN2384CPL	24 x 84 x 23	100	266	26.83	\$1365	\$154
PN2360CPR	24 x 60 x 23	100	190	19.17	\$1228	\$142
PN2366CPR	24 x 66 x 23	100	233	25	\$1268	\$150
PN2372CPR	24 x 72 x 23	100	228	23	\$1310	\$148
PN2378CPR	24 x 78 x 23	100	254	30	\$1340	\$154
PN2384CPR	24 x 84 x 23	100	266	26.83	\$1365	\$154

Standard with 34"W box and lateral file drawer. Pull-out equipment shelf can support up to 80lbs. Adjustable 6 position shelf. File bars included for front-to-back letter and legal filing capability. Lock on file drawer secures both drawers. Wire management grommet on surface and internal pass-through at back of lower shelf. Supports Overlapping Return with metal leg and spacer for 23"H credenza, Overlapping Wedge Shaped Return with metal leg and spacer for 23"H credenza, and Overlapping Bridges with metal spacer for 23"H credenza. Shipped Fully Assembled.

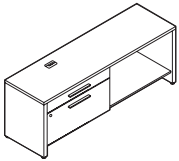

LEFT

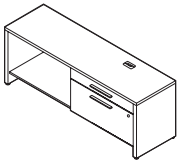

RIGHT

23" H Narrow Credenza*

PN2354NCL	20 x 54 x 23	92.5	230	21	\$1059	\$143
PN2360NCL	20 x 60 x 23	92.5	240	23	\$1065	\$144
PN2354NCR	20 x 54 x 23	92.5	230	21	\$1059	\$143
PN2360NCR	20 x 60 x 23	92.5	240	23	\$1065	\$144

Specify PNxxxxNCL for **LEFT** or PNxxxxNCR for **RIGHT**.

20"D. Standard with 30"W box and lateral file drawer. File bars included for front-to-back letter and legal filing capability. Lock on file drawer secures both drawers. Wire management grommet on surface and internal pass-through at back of lower shelf. Supports Overlapping Return with metal leg and spacer for 23"H credenza, Overlapping Wedge Shaped Return with metal leg and spacer for 23"H credenza, and Overlapping Bridges with metal spacer for 23"H credenza. Shipped Fully Assembled.

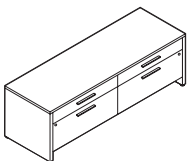

23" H Double Credenza

PN2372CRD	24 x 72 x 23	92.5	275	27	\$1395	\$189
-----------	--------------	------	-----	----	---------------	--------------

Standard with locking 34"W box and lateral file drawer on each side. File bars included for front-to-back letter and legal filing capability. Lock on file drawer secures both drawers. Shipped Fully Assembled.

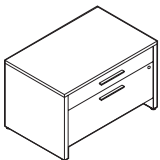

23" H Single Credenza

PN2337CRS	24 x 37 x 23	100	125	15	\$948	\$128
-----------	--------------	-----	-----	----	--------------	--------------

Standard with 34" w box and lateral file drawer. File bars included for front-to-back letter and legal filing capability. Lock on file drawer secures both drawers. Shipped Fully Assembled.

Required Specifications

Top finish
Base finish
Drawer front finish

Optional Specifications

HP laminate
Grommet
RSG - remove grommet*

Accessories

Power block
Cushion

23"H CREDENZAS

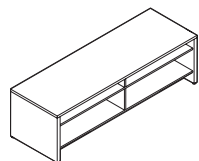

23"H Open Credenza

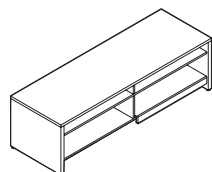

LEFT

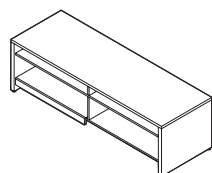

RIGHT

23"H Open Credenza
w/Pull-Out Equipment Tray

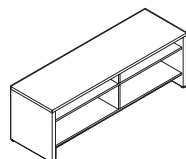

23"H Narrow Open Credenza

MODEL# DIMENSIONS FREIGHT CLASS WT/LBS. CUBIC FT. LIST PRICE HP ADD

D x W x H

PN2360CO	24 x 60 x 23	85	276	23	\$933	\$126
PN2366CO	24 x 66 x 23	92.5	286	25	\$987	\$134
PN2372CO	24 x 72 x 23	92.5	296	27.50	\$1012	\$137
PN2378CO	24 x 78 x 23	92.5	306	30	\$1060	\$144
PN2384CO	24 x 84 x 23	100	316	32	\$1127	\$153

Open storage with adjustable 6 position upper shelves with pass-throughs at back of lower shelves. Supports Overlapping Return with metal leg and spacer for 23"H credenza, Overlapping Wedge Shaped Return with metal leg and spacer for 23"H credenza, and Overlapping Bridges with metal spacer for 23"H credenza. Shipped Fully Assembled.

PN2360POL	24 x 60 x 23	85	282	23	\$1184	\$160
PN2366POL	24 x 66 x 23	92.5	292	25	\$1220	\$165
PN2372POL	24 x 72 x 23	92.5	302	27.50	\$1244	\$168
PN2378POL	24 x 78 x 23	92.5	312	30	\$1301	\$176
PN2384POL	24 x 84 x 23	92.5	322	32	\$1324	\$179

PN2360POR	24 x 60 x 23	85	282	23	\$1184	\$160
PN2366POR	24 x 66 x 23	92.5	292	25	\$1220	\$165
PN2372POR	24 x 72 x 23	92.5	302	27.50	\$1244	\$168
PN2378POR	24 x 78 x 23	92.5	312	30	\$1301	\$176
PN2384POR	24 x 84 x 23	92.5	322	32	\$1324	\$179

Specify PNxxxxPOL for **LEFT** or PNxxxxPOR for **RIGHT**.

Open storage with adjustable 6 position upper shelves. Pass-throughs at back of lower shelves and pull-out equipment tray that can support up to 80lbs. Supports Overlapping Return with metal leg and spacer for 23"H credenza, Overlapping Wedge Shaped Return with metal leg and spacer for 23"H credenza, and Overlapping Bridges with metal spacer for 23"H credenza. Shipped Fully Assembled.

PN2354NO	20 x 54 x 23	92.5	195	18	\$986	\$134
PN2360NO	20 x 60 x 23	92.5	205	19	\$1023	\$139

20"D open storage. Adjustable 6 position upper shelves with pass-throughs at back of lower shelves. Supports Overlapping Return with metal leg and spacer for 23"H credenza, Overlapping Wedge Shaped Return with metal leg and spacer for 23"H credenza, and Overlapping Bridges with metal spacer for 23"H credenza. Shipped Fully Assembled.

Required Specifications

Top finish
Base finish

Optional Specifications

HP laminate
Grommet (PNxxxxNO)

Accessories

Power block
Cushion

CUSHIONS FOR 23"H CREDENZAS

MODEL#	DIMENSIONS	FREIGHT CLASS	WT/LBS.	CUBIC FT.	GRADE	LIST	GRADE	LIST
PN2430CU	24 x 30 x 2.5	150	13	2.40		D x W x H		
					1	\$206	7	\$445
					2	\$242	8	\$544
					3	\$270	9	\$592
					4	\$312	10	\$685
					5	\$371	11	\$810
PN2433CU	24 x 33 x 2.5	150	13	2.40	6	\$393	12	\$967
					1	\$225	7	\$543
					2	\$272	8	\$676
					3	\$310	9	\$740
					4	\$366	10	\$863
					5	\$445	11	\$1031
PN2436CU	24 x 36 x 2.5	250	7	2	6	\$474	12	\$1240
					1	\$239	7	\$597
					2	\$292	8	\$746
					3	\$334	9	\$818
					4	\$397	10	\$957
					5	\$487	11	\$1145
PN2439CU	24 x 39 x 2.5	150	14	2.40	6	\$519	12	\$1380
					1	\$255	7	\$613
					2	\$308	8	\$762
					3	\$350	9	\$834
					4	\$413	10	\$973
					5	\$503	11	\$1161
PN2442CU	24 x 42 x 2.5	150	14	2.40	6	\$535	12	\$1396
					1	\$267	7	\$625
					2	\$320	8	\$774
					3	\$362	9	\$846
					4	\$425	10	\$985
					5	\$515	11	\$1173
PN2027CU	20 x 27 x 2.5	150	12	2.40	6	\$547	12	\$1408
					1	\$182	7	\$381
					2	\$212	8	\$464
					3	\$235	9	\$504
					4	\$270	10	\$581
					5	\$320	11	\$686
PN2030CU	20 x 30 x 2.5	150	12	2.40	6	\$338	12	\$816
					1	\$197	7	\$396
					2	\$227	8	\$479
					3	\$250	9	\$519
					4	\$285	10	\$596
					5	\$335	11	\$701
PN2030CU	20 x 30 x 2.5	150	12	2.40	6	\$353	12	\$831
					1	\$197	7	\$396
					2	\$227	8	\$479
					3	\$250	9	\$519
					4	\$285	10	\$596
					5	\$335	11	\$701

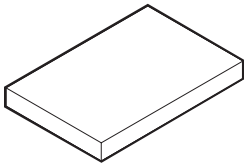

Cushion for 23"H Credenzas

Cushion attaches with Velcro strips. Fits **24"d** credenzas.

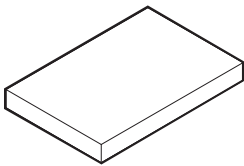

Cushion for 23"H Narrow Credenzas

Cushion attaches with Velcro strips. Fits **20"d** credenzas.

Required Specifications
Fabric

CUSHIONS FOR 23"H CREDENZAS

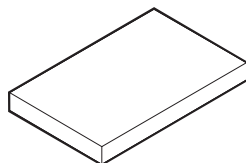

Cushion for 23"H Single Credenza**

MODEL#	DIMENSIONS	FREIGHT CLASS	WT./LBS.	CUBIC FT.	GRADE	LIST	GRADE	LIST
	D x W x H							
PN2437CU	24 x 37 x 2.5	150	14	2.40	1	\$252	7	\$610
					2	\$305	8	\$760
					3	\$347	9	\$831
					4	\$410	10	\$970
					5	\$500	11	\$1158
					6	\$532	12	\$1393

Cushion attaches with Velcro strips. Fits **PN2337CRS** credenza.

52"H STORAGE CABINETS

LIST PRICE GLASS SHELF ADD

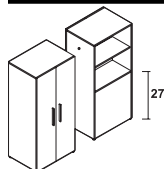

52"H Wardrobe w/Bookshelf at 27"H*

PN57CWB	24 x 18 x 52	125	97.50	13	\$1066	\$57
---------	--------------	-----	-------	----	--------	------

Standard with double locking doors, 6" coat hanging space with hook and full depth space for personal items in bottom. One adjustable laminate shelf. Fixed bottom shelf aligns with **27"H** surface. Outside accessory hook. Shipped Fully Assembled.

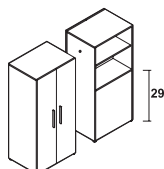

52"H Wardrobe w/Bookshelf at 29"H*

PN59CWB	24 x 18 x 52	125	97.50	13	\$1104	\$57
---------	--------------	-----	-------	----	--------	------

Standard with double locking doors, 6" coat hanging space with hook and full depth space for personal items in bottom. One adjustable laminate shelf. Fixed bottom shelf aligns with **29"H** surface. Outside accessory hook. Shipped Fully Assembled.

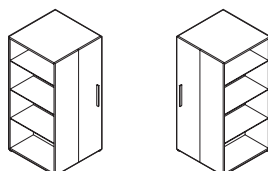

LEFT **RIGHT**
52"H Tower Wardrobe w/Full Height Bookcase*

PN52TWBL	24 x 24 x 52	125	129	17.33	\$1242	\$171
PN52TWBR	24 x 24 x 52	125	129	17.33	\$1242	\$171

Specify PN52TWBL for **LEFT** or PN52TWBR for **RIGHT**.

Locking wardrobe with full height bookcase. Three adjustable laminate shelves with fixed bottom laminate shelf. Coat rail. Shipped Fully Assembled.

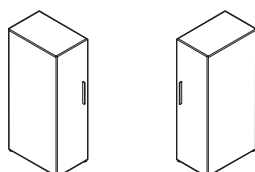

LEFT **RIGHT**
52"H Wardrobe*

PN1652WDL	24 x 16 x 52	125	84	11.56	\$738	N/A
PN1652WDR	24 x 16 x 52	125	84	11.56	\$738	N/A

Specify PN1652WDL for **LEFT** or PN1652WDR for **RIGHT**.

Locking wardrobe with coat rail. Shipped Fully Assembled.

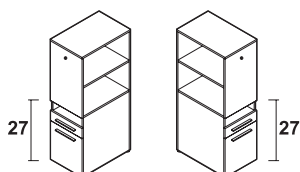

LEFT **RIGHT**
52"H Storage Cabinet w/Bookshelf at 27"H*

PN57CSBFL	24 x 16 x 52	100	102	11.56	\$1062	\$70
PN57CSBFR	24 x 16 x 52	100	102	11.56	\$1062	\$70

Specify PN57CSBFL for **LEFT** or PN57CSBFR for **RIGHT**.

Open Shelf/Box/File Drawer. Lock on file drawer secures both drawers. One adjustable laminate shelf. Fixed bottom shelf aligns with **27"H** surfaces. Outside accessory hook. Shipped Fully Assembled.

Required Specifications

Top finish*
Base finish*
Drawer/door front finish*
Fabric**

Optional Specifications

No Lock*
Glass shelf*

52" H STORAGE CABINETS

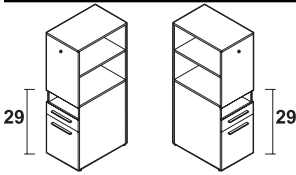

LEFT RIGHT

52" H Storage Cabinet w/Bookshelf at 29" H

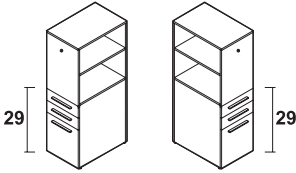

LEFT RIGHT

52" H Storage Cabinet w/Bookshelf at 29" H

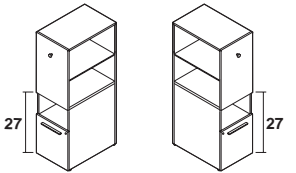

LEFT RIGHT

52" H Storage Cabinet w/Large Shelf, File and Bookshelf at 27" H

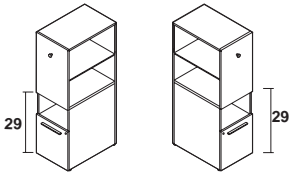

LEFT RIGHT

52" H Storage Cabinet w/Large Shelf, File and Bookshelf at 29" H

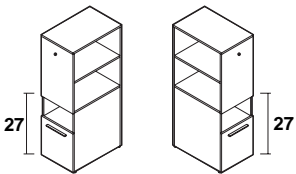

LEFT RIGHT

52" H Recycling Cabinet w/Bookshelf at 27" H

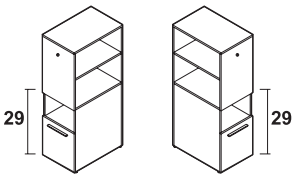

LEFT RIGHT

52" H Recycling Cabinet w/Bookshelf at 29" H

MODEL# DIMENSIONS FREIGHT CLASS WT/LBS. CUBIC FT. LIST PRICE GLASS SHELF ADD

	D x W x H					
PN59CSBFL	24 x 16 x 52	100	102	11.56	\$1077	\$70
PN59CSBFR	24 x 16 x 52	100	102	11.56	\$1077	\$70

Specify PN59CSBFL for **LEFT** or PN59CSBFR for **RIGHT**.

Glass Shelf Option:

Open Shelf/Box/File Drawer. Lock on file drawer secures both drawers. One adjustable laminate shelf. Fixed bottom shelf aligns with **29" H** surfaces. Outside accessory hook. Shipped Fully Assembled.

PN59CBBFL	24 x 16 x 52	100	102	11.56	\$1139	\$70
PN59CBBFR	24 x 16 x 52	100	102	11.56	\$1139	\$70

Specify PN59CBBFL for **LEFT** or PN59CBBFR for **RIGHT**.

Glass Shelf Option:

Box/Box/File Drawer. Lock on file drawer secures both drawers. One adjustable laminate shelf. Fixed bottom shelf aligns with **29" H** surfaces. Outside accessory hook. Shipped Fully Assembled.

PN57CSFL	24 x 16 x 52	100	117	13.75	\$1058	\$70
PN57CSFR	24 x 16 x 52	100	117	13.75	\$1058	\$70

Specify PN57CSFL for **LEFT** or PN57CSFR for **RIGHT**.

Glass Shelf Option:

Locking **file drawer** with **open shelf** above. One adjustable laminate shelf. Fixed bottom shelf aligns with **27" H** surfaces. Outside accessory hook. Shipped Fully Assembled.

PN59CSFL	24 x 16 x 52	100	117	13.75	\$1073	\$70
PN59CSFR	24 x 16 x 52	100	117	13.75	\$1073	\$70

Specify PN59CSFL for **LEFT** or PN59CSFR for **RIGHT**.

Glass Shelf Option:

Locking **file drawer** with **open shelf** above. One adjustable laminate shelf. Fixed bottom shelf aligns with **29" H** surfaces. Outside accessory hook. Shipped Fully Assembled.

PN57RCSL	24 x 16 x 52	100	102	11.56	\$996	\$70
PN57RCSR	24 x 16 x 52	100	102	11.56	\$996	\$70

Specify PN57RCSL for **LEFT** or PN57RCSR for **RIGHT**.

Glass Shelf Option:

Drawer with one waste bin, one recycling bin and an open shelf above. One adjustable laminate shelf. Fixed bottom shelf aligns with **27" H** surfaces. Outside accessory hook. Shipped Fully Assembled.

PN59RCSL	24 x 16 x 52	100	102	11.56	\$1006	\$70
PN59RCSR	24 x 16 x 52	100	102	11.56	\$1006	\$70

Specify PN59RCSL for **LEFT** or PN59RCSR for **RIGHT**.

Glass Shelf Option:

Drawer with one waste bin, one recycling bin and an open shelf above. One adjustable laminate shelf. Fixed bottom shelf aligns with **29" H** surfaces. Outside accessory hook. Shipped Fully Assembled.

Required Specifications

- Top finish
- Base finish
- Drawer/door front finish

Optional Specifications

- No lock (where applicable)
- Glass shelf

52" H STORAGE CABINETS

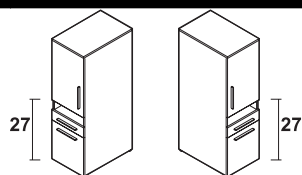

LEFT **RIGHT**
52" H Storage Cabinet w/Door at 27" H

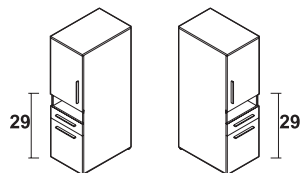

LEFT **RIGHT**
52" H Storage Cabinet w/Door at 29" H

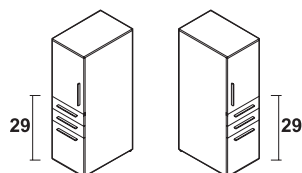

LEFT **RIGHT**
52" H Storage Cabinet w/Door at 29" H

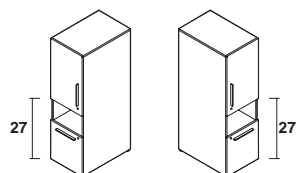

LEFT **RIGHT**
52" H Storage Cabinet w/Door at 27" H

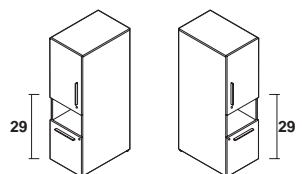

LEFT **RIGHT**
52" H Storage Cabinet w/Door at 29" H

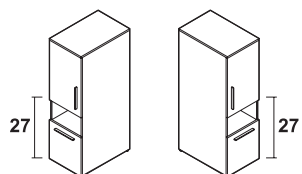

LEFT **RIGHT**
52" H Recycling Cabinet w/Door at 27" H

MODEL#	DIMENSIONS	FREIGHT CLASS	WT/LBS.	CUBIC FT.	LIST PRICE	GLASS SHELF ADD
	D x W x H					
PN57DSBFL	24 x 16 x 52	100	102	11.56	\$1168	N/A
PN57DSBFR	24 x 16 x 52	100	102	11.56	\$1168	N/A

Specify PN57DSBFL for **LEFT** or PN57DSBFR for **RIGHT**.

Open Shelf/Box/File Drawer. Lock on file drawer secures both drawers. Upper storage cabinet with locking door and one adjustable laminate shelf inside. Door aligns with **27" H** surfaces. Shipped Fully Assembled.

PN59DSBFL	24 x 16 x 52	100	102	11.56	\$1191	N/A
PN59DSBFR	24 x 16 x 52	100	102	11.56	\$1191	N/A

Specify PN59DSBFL for **LEFT** or PN59DSBFR for **RIGHT**.

Open Shelf/Box/File Drawer. Lock on file drawer secures both drawers. Upper storage cabinet with locking door and one adjustable laminate shelf inside. Door aligns with **29" H** surfaces. Shipped Fully Assembled.

PN59DBBFL	24 x 16 x 52	100	102	11.56	\$1245	N/A
PN59DBBFR	24 x 16 x 52	100	102	11.56	\$1245	N/A

Specify PN59DBBFL for **LEFT** or PN59DBBFR for **RIGHT**.

Box/Box/File Drawer. Lock on file drawer secures file and lower box drawers. Upper storage cabinet with locking door and one adjustable laminate shelf inside. Door aligns with **29" H** surfaces. Shipped Fully Assembled.

PN57DCSFL	24 x 16 x 52	100	117	13.75	\$1054	N/A
PN57DCSFR	24 x 16 x 52	100	117	13.75	\$1054	N/A

Specify PN57DCSFL for **LEFT** or PN57DCSFR for **RIGHT**.

Locking **file drawer** with **open shelf** above. Upper storage cabinet with locking door and one adjustable laminate shelf. Door aligns with **27" H** surfaces. Shipped Fully Assembled.

PN59DCSFL	24 x 16 x 52	100	117	13.75	\$1069	N/A
PN59DCSFR	24 x 16 x 52	100	117	13.75	\$1069	N/A

Specify PN59DCSFL for **LEFT** or PN59DCSFR for **RIGHT**.

Locking **file drawer** with **open shelf** above. Upper storage cabinet with locking door and one adjustable laminate shelf. Door aligns with **29" H** surfaces. Shipped Fully Assembled.

PN57DRCSL	24 x 16 x 52	100	102	11.56	\$1034	N/A
PN57DRCSR	24 x 16 x 52	100	102	11.56	\$1034	N/A

Specify PN57DRCSL for **LEFT** or PN57DRCSR for **RIGHT**.

Upper storage cabinet with locking door. Drawer with one waste bin, one recycling bin, and an open shelf above. One adjustable laminate shelf inside locking cabinet door. Door aligns with **27" H** surfaces. Shipped Fully Assembled.

Required Specifications

Top finish
Base finish
Drawer/door front finish

Optional Specifications

No lock (where applicable)

52" H STORAGE CABINETS

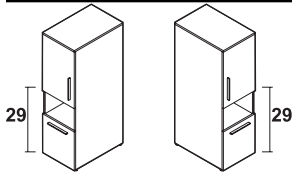

LEFT

RIGHT

52" H Recycling Cabinet w/Door at 29" H

MODEL# DIMENSIONS FREIGHT CLASS WT/LBS. CUBIC FT. LIST PRICE GLASS SHELF ADD

	D x W x H					
PN59DRCSL	24 x 16 x 52	100	102	11.56	\$1057	N/A
PN59DRCSR	24 x 16 x 52	100	102	11.56	\$1057	N/A

Specify PN59DRCSL for **LEFT** or PN59DRCSR for **RIGHT**.

Upper storage cabinet with locking door. Drawer with one waste bin, one recycling bin, and an open shelf above. One adjustable laminate shelf inside locking cabinet door. Door aligns with **29" H** surfaces. Shipped Fully Assembled.

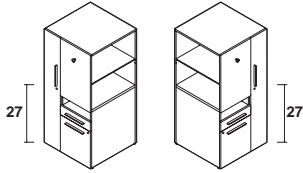

LEFT

RIGHT

52" H Storage Tower w/Wardrobe, Shelf and Bookshelf at 27" H

PN57TSBFL	24 x 24 x 52	92.5	225	21	\$1276	\$70
PN57TSBFR	24 x 24 x 52	92.5	225	21	\$1276	\$70

Specify PN57TSBFL for **LEFT** or PN57TSBFR for **RIGHT**.

Open Shelf/Box/File drawer. Lock on file drawer secures both drawers. One adjustable laminate shelf. Fixed bottom shelf aligns with **27" H** surfaces. Outside accessory hook and locking wardrobe with coat rail. Shipped Fully Assembled.

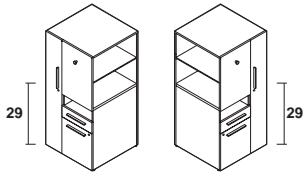

LEFT

RIGHT

52" H Storage Tower w/Wardrobe, Shelf and Bookshelf at 29" H

PN59TSBFL	24 x 24 x 52	92.5	225	21	\$1080	\$70
PN59TSBFR	24 x 24 x 52	92.5	225	21	\$1080	\$70

Specify PN59TSBFL for **LEFT** or PN59TSBFR for **RIGHT**.

Open Shelf/Box/File drawer. Lock on file drawer secures both drawers. One adjustable laminate shelf. Fixed bottom shelf aligns with **29" H** surfaces. Outside accessory hook and locking wardrobe with coat rail. Shipped Fully Assembled.

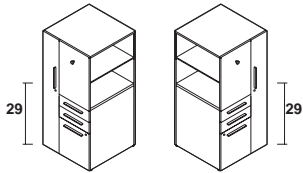

LEFT

RIGHT

52" H Storage Tower w/Wardrobe, and Bookshelf at 29" H

PN59TBBFL	24 x 24 x 52	92.5	250	21	\$1475	\$70
PN59TBBFR	24 x 24 x 52	92.5	250	21	\$1475	\$70

Specify PN59TBBFL for **LEFT** or PN59TBBFR for **RIGHT**.

Box/Box/File drawer. Lock on file drawer secures file and lower box drawer. One adjustable laminate shelf. Fixed bottom shelf aligns with **29" H** surfaces. Outside accessory hook and locking wardrobe with coat rail. Shipped Fully Assembled.

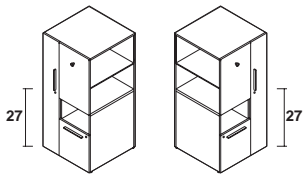

LEFT

RIGHT

52" H Storage Tower w/Wardrobe, Shelf, File and Bookshelf at 27" H

PN57TSFL	24 x 24 x 52	92.5	238	21	\$1195	\$70
PN57TSFR	24 x 24 x 52	92.5	238	21	\$1195	\$70

Specify PN57TSFL for **LEFT** or PN57TSFR for **RIGHT**.

Locking **file drawer** with **open shelf** above. One adjustable laminate shelf. Fixed bottom shelf aligns with **27" H** surfaces. Outside accessory hook. Locking wardrobe with coat rail. Shipped Fully Assembled.

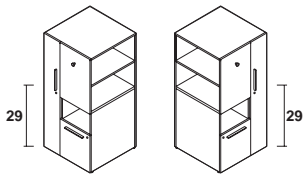

LEFT

RIGHT

52" H Storage Tower w/Wardrobe, Shelf, File and Bookshelf at 29" H

PN59TSFL	24 x 24 x 52	92.5	238	21	\$1221	\$70
PN59TSFR	24 x 24 x 52	92.5	238	21	\$1221	\$70

Specify PN59TSFL for **LEFT** or PN59TSFR for **RIGHT**.

Locking **file drawer** with **open shelf** above. One adjustable laminate shelf. Fixed bottom shelf aligns with **29" H** surfaces. Outside accessory hook. Locking wardrobe with coat rail. Shipped Fully Assembled.

Required Specifications

Top finish
Base finish
Drawer/door front finish

Optional Specifications

No lock (where applicable)
Glass shelf (where applicable)

52" H STORAGE CABINETS

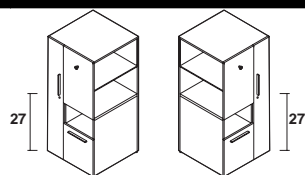

LEFT **RIGHT**

52" H Storage Tower w/Wardrobe, Shelf, Recycling and Bookshelf at 27" H

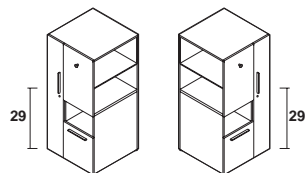

LEFT **RIGHT**

52" H Storage Tower w/Wardrobe, Shelf, Recycling and Bookshelf at 29" H

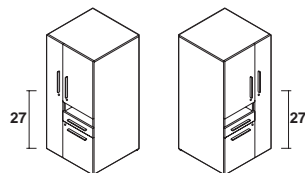

LEFT **RIGHT**

52" H Storage Tower w/Wardrobe, Shelf/Box/File and Door at 27" H

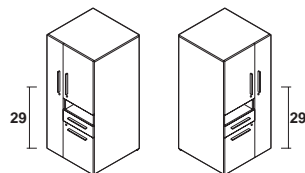

LEFT **RIGHT**

52" H Storage Tower w/Wardrobe, Shelf/Box/File and Door at 29" H

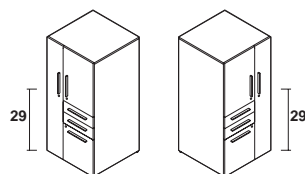

LEFT **RIGHT**

52" H Storage Tower w/Wardrobe, Shelf, Box/Box/File and Door at 29" H

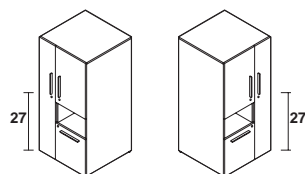

LEFT **RIGHT**

52" H Storage Tower w/Wardrobe, Shelf, File and Door at 27" H

MODEL#	DIMENSIONS D x W x H	FREIGHT CLASS	WT./LBS.	CUBIC FT.	LIST PRICE	GLASS SHELF ADD
PN57RTSL	24 x 24 x 52	92.5	238	21	\$1370	\$70
PN57RTSR	24 x 24 x 52	92.5	238	21	\$1370	\$70

Specify PN57RTSL for **LEFT** or PN57RTSR for **RIGHT**.

Drawer with one waste and one recycling bin. Open shelf above. One adjustable laminate shelf. Fixed bottom shelf aligns with **27" H** surfaces. Outside accessory hook. Locking wardrobe with coat rail. Shipped Fully Assembled.

PN59RTSL	24 x 24 x 52	92.5	238	21	\$1370	\$70
PN59RTSR	24 x 24 x 52	92.5	238	21	\$1370	\$70

Specify PN59RTSL for **LEFT** or PN59RTSR for **RIGHT**.

Drawer with one waste and one recycling bin. Open shelf above. One adjustable laminate shelf. Fixed bottom shelf aligns with **29" H** surfaces. Outside accessory hook. Locking wardrobe with coat rail. Shipped Fully Assembled.

PN57SBFTL	24 x 24 x 52	92.5	234	21	\$1434	N/A
PN57SBFTR	24 x 24 x 52	92.5	234	21	\$1434	N/A

Specify PN57SBFTL for **LEFT** or PN57SBFTR for **RIGHT**.

Open Shelf/Box/File drawer. Lock on file drawer secures both drawers. Upper storage cabinet with locking door and one adjustable laminate shelf inside. Door aligns with **27" H** surfaces. Locking wardrobe with coat rail. Shipped Fully Assembled.

PN59SBFTL	24 x 24 x 52	92.5	234	21	\$1434	N/A
PN59SBFTR	24 x 24 x 52	92.5	234	21	\$1434	N/A

Specify PN59SBFTL for **LEFT** or PN59SBFTR for **RIGHT**.

Open Shelf/Box/File drawer. Lock on file drawer secures both drawers. Upper storage cabinet with locking door and one adjustable laminate shelf inside. Door aligns with **29" H** surfaces. Locking wardrobe with coat rail. Shipped Fully Assembled.

PN59BBFTL	24 x 24 x 52	92.5	234	21	\$1513	N/A
PN59BBFTR	24 x 24 x 52	92.5	234	21	\$1513	N/A

Specify PN59BBFTL for **LEFT** or PN59BBFTR for **RIGHT**.

Box/Box/File drawer. Lock on file drawer secures file and lower box drawers. Upper storage cabinet with locking door and one adjustable laminate shelf inside. Door aligns with **29" H** surfaces. Locking wardrobe with coat rail. Shipped Fully Assembled.

PN57DTSFL	24 x 24 x 52	92.5	234	21	\$1348	N/A
PN57DTSFR	24 x 24 x 52	92.5	234	21	\$1348	N/A

Specify PN57DTSFL for **LEFT** or PN57DTSFR for **RIGHT**.

Locking **file drawer** with **open shelf** above. Upper storage cabinet with locking door and one adjustable laminate shelf inside. Door aligns with **27" H** surfaces. Locking wardrobe with coat rail. Shipped Fully Assembled.

Required Specifications

Top finish
Base finish
Drawer/door front finish

Optional Specifications

No lock (where applicable)
Glass shelf (where applicable)

52" H STORAGE CABINETS

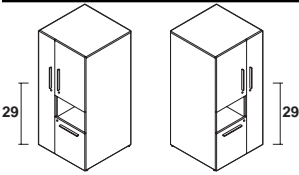

LEFT **RIGHT**
52" H Storage Tower w/Wardrobe, Shelf, File and Door at 29" H

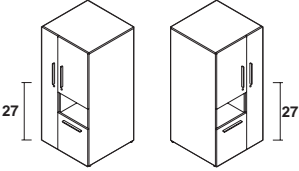

LEFT **RIGHT**
52" H Storage Tower w/Wardrobe, Shelf, Recycling and Door at 27" H

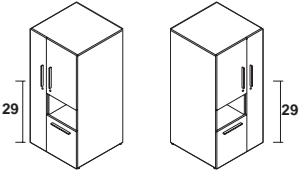

LEFT **RIGHT**
52" H Storage Tower w/Wardrobe, Shelf, Recycling and Door at 29" H

MODEL#	DIMENSIONS	FREIGHT CLASS	WT/LBS.	CUBIC FT.	LIST PRICE	GLASS SHELF ADD
	D x W x H					
PN59DTSFL	24 x 24 x 52	92.5	234	21	\$1348	N/A
PN59DTSFR	24 x 24 x 52	92.5	234	21	\$1348	N/A

Specify PN59DTSFL for **LEFT** or PN59DTSFR for **RIGHT**.

Locking **file drawer** with **open shelf** above. Upper storage cabinet with locking door and one adjustable laminate shelf inside. Door aligns with **29" H** surfaces. Locking wardrobe with coat rail. Shipped Fully Assembled.

PN57DRTSL	24 x 24 x 52	92.5	234	21	\$1460	N/A
PN57DRTSR	24 x 24 x 52	92.5	234	21	\$1460	N/A

Specify PN57DRTSL for **LEFT** or PN57DRTSR for **RIGHT**.

Drawer with one waste and one recycling bin. Open shelf above. Upper storage cabinet with locking door and one adjustable laminate shelf inside. Door aligns with **27" H** surfaces. Locking wardrobe with coat rail. Shipped Fully Assembled.

PN59DRTSL	24 x 24 x 52	92.5	234	21	\$1460	N/A
PN59DRTSR	24 x 24 x 52	92.5	234	21	\$1460	N/A

Specify PN59DRTSL for **LEFT** or PN59DRTSR for **RIGHT**.

Drawer with one waste and one recycling bin. Open shelf above. Upper storage cabinet with locking door and one adjustable laminate shelf inside. Door aligns with **29" H** surfaces. Locking wardrobe with coat rail. Shipped Fully Assembled.

66" H STORAGE CABINETS

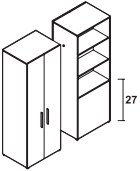

66" H Wardrobe w/Bookshelf at 27" H

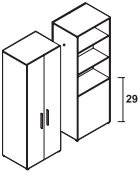

66" H Wardrobe w/Bookshelf at 29" H

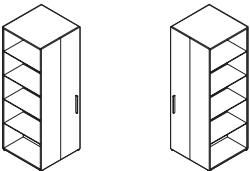

LEFT **RIGHT**
66" H Tower Wardrobe w/Full Height Bookcase

PN67CWB	24 x 18 x 66	125	124	16.50	\$1252	\$114
---------	--------------	-----	-----	-------	---------------	--------------

Standard with double locking doors and 6" coat hanging space with hook. Full depth space for personal items in bottom, two adjustable laminate shelves. Fixed bottom shelf aligns with **27" H** surfaces. Outside accessory hook. Shipped Fully Assembled.

PN69CWB	24 x 18 x 66	125	124	16.50	\$1292	\$114
---------	--------------	-----	-----	-------	---------------	--------------

Standard with double locking doors and 6" coat hanging space with hook. Full depth space for personal items in bottom, two adjustable laminate shelves. Fixed bottom shelf aligns with **29" H** surfaces. Outside accessory hook. Shipped Fully Assembled.

PN66TWBL	24 x 24 x 66	125	165	22	\$1441	\$228
PN66TWBR	24 x 24 x 66	125	165	22	\$1441	\$228

Specify PN66TWBL for **LEFT** or PN66TWBR for **RIGHT**.

Locking wardrobe and full height bookcase. Four adjustable laminate shelves with fixed bottom laminate shelf. Coat rail. Shipped Fully Assembled.

Required Specifications

- Top finish
- Base finish
- Drawer/door front finish

Optional Specifications

- No lock
- Glass shelf (where applicable)

66" H STORAGE CABINETS

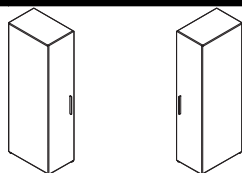

LEFT
66" H Wardrobe

RIGHT

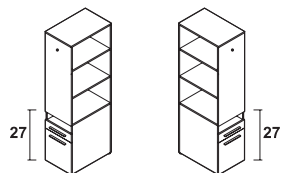

LEFT
**66" H Storage Cabinet
w/Bookshelf at 27" H**

RIGHT

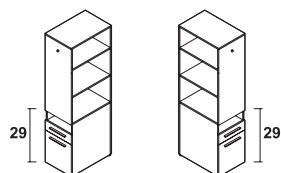

LEFT
**66" H Storage Cabinet
w/Bookshelf at 29" H**

RIGHT

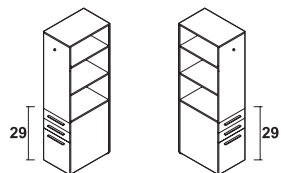

LEFT
**66" H Storage Cabinet
w/Bookshelf at 29" H**

RIGHT

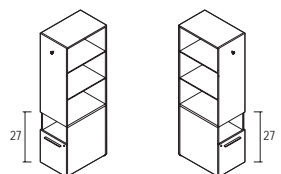

LEFT
**66" H Storage Cabinet w/Large Shelf,
File and Bookshelf at 27" H**

RIGHT

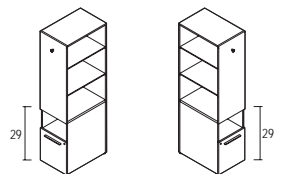

LEFT
**66" H Storage Cabinet w/Large Shelf,
File and Bookshelf at 29" H**

RIGHT

MODEL#	DIMENSIONS	FREIGHT CLASS	WT/LBS.	CUBIC FT.	LIST PRICE	GLASS SHELF ADD
--------	------------	---------------	---------	-----------	------------	-----------------

D x W x H

PN1666WDL	24 x 16 x 66	125	106	14.67	\$835	N/A
PN1666WDR	24 x 16 x 66	125	106	14.67	\$835	N/A

Specify PN1666WDL for **LEFT** or PN1666WDR for **RIGHT**.

Locking wardrobe with coat rail and fixed shelf above. Shipped Fully Assembled.

PN67CSBFL	24 x 16 x 66	100	130	14.67	\$1142	\$139
PN67CSBFR	24 x 16 x 66	100	130	14.67	\$1142	\$139

Specify PN67CSBFL for **LEFT** or PN67CSBFR for **RIGHT**.

Open Shelf/Box/File Drawer. Lock on file drawer secures both drawers. Two adjustable laminate shelves. Fixed bottom shelf aligns with **27" H** surfaces. Outside accessory hook. Shipped Fully Assembled.

PN69CSBFL	24 x 16 x 66	100	130	14.67	\$1142	\$139
PN69CSBFR	24 x 16 x 66	100	130	14.67	\$1142	\$139

Specify PN69CSBFL for **LEFT** or PN69CSBFR for **RIGHT**.

Open Shelf/Box/File Drawer. Lock on file drawer secures both drawers. Two adjustable laminate shelves. Fixed bottom shelf aligns with **29" H** surfaces. Outside accessory hook. Shipped Fully Assembled.

PN69CBBFL	24 x 16 x 66	100	130	14.67	\$1221	\$139
PN69CBBFR	24 x 16 x 66	100	130	14.67	\$1221	\$139

Specify PN69CBBFL for **LEFT** or PN69CBBFR for **RIGHT**.

Box/Box/File Drawer. Lock on file drawer secures file and lower box drawer. Two adjustable laminate shelves. Fixed bottom shelf aligns with **29" H** surfaces. Outside accessory hook. Shipped Fully Assembled.

PN67CSFL	24 x 16 x 66	100	137	17	\$1193	\$139
PN67CSFR	24 x 16 x 66	100	137	17	\$1193	\$139

Specify PN67CSFL for **LEFT** or PN67CSFR for **RIGHT**.

Locking **file drawer** with **open shelf** above. Two adjustable laminate shelves. Fixed bottom shelf aligns with **27" H** surfaces. Outside accessory hook. Shipped Fully Assembled.

PN69CSFL	24 x 16 x 66	100	137	17	\$1193	\$139
PN69CSFR	24 x 16 x 66	100	137	17	\$1193	\$139

Specify PN69CSFL for **LEFT** or PN69CSFR for **RIGHT**.

Locking **file drawer** with **open shelf** above. Two adjustable laminate shelves. Fixed bottom shelf aligns with **29" H** surfaces. Outside accessory hook. Shipped Fully Assembled.

Required Specifications

Top finish
Base finish
Drawer/door front finish

Optional Specifications

No lock
Glass shelf (where applicable)

66" H STORAGE CABINETS

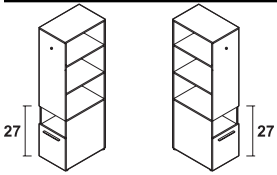

LEFT
RIGHT
66" H Recycling Cabinet
w/Bookshelf at 27" H

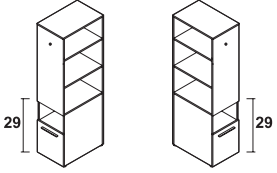

LEFT
RIGHT
66" H Recycling Cabinet
w/Bookshelf at 29" H

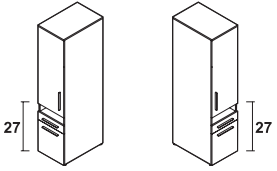

LEFT
RIGHT
66" H Storage Cabinet w/Door at 27" H

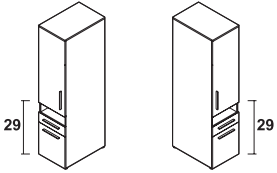

LEFT
RIGHT
66" H Storage Cabinet w/Door at 29" H

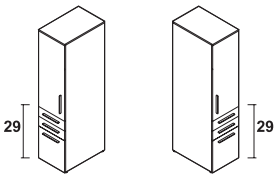

LEFT
RIGHT
66" H Storage Cabinet w/Door at 29" H

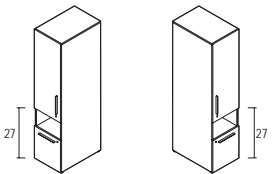

LEFT
RIGHT
66" H Storage Cabinet w/Large Shelf,
File and Door at 27" H

MODEL# DIMENSIONS FREIGHT CLASS WT/LBS. CUBIC FT. LIST PRICE GLASS SHELF ADD

	D x W x H					
PN67RCSL	24 x 16 x 66	100	130	14.67	\$1096	\$139
PN67RCSR	24 x 16 x 66	100	130	14.67	\$1096	\$139

Specify PN67RCSL for **LEFT** or PN67RCSR for **RIGHT**.

Drawer with one waste bin and one recycling bin. Open shelf above. Two adjustable laminate shelves. Fixed bottom shelf aligns with **27" H** surfaces. Outside accessory hook. Shipped Fully Assembled.

PN69RCSL	24 x 16 x 66	100	130	14.67	\$1096	\$139
PN69RCSR	24 x 16 x 66	100	130	14.67	\$1096	\$139

Specify PN69RCSL for **LEFT** or PN69RCSR for **RIGHT**.

Drawer with one waste bin and one recycling bin. Open shelf above. Two adjustable laminate shelves. Fixed bottom shelf aligns with **29" H** surfaces. Outside accessory hook. Shipped Fully Assembled.

PN67DSBFL	24 x 16 x 66	100	130	14.67	\$1210	N/A
PN67DSBFR	24 x 16 x 66	100	130	14.67	\$1210	N/A

Specify PN67DSBFL for **LEFT** or PN67DSBFR for **RIGHT**.

Open Shelf/Box/File Drawer. Lock on file drawer secures both drawers. Upper storage cabinet with locking door and two adjustable laminate shelves inside. Door aligns with **27" H** surfaces. Shipped Fully Assembled.

PN69DSBFL	24 x 16 x 66	100	130	14.67	\$1252	N/A
PN69DSBFR	24 x 16 x 66	100	130	14.67	\$1252	N/A

Specify PN69DSBFL for **LEFT** or PN69DSBFR for **RIGHT**.

Open Shelf/Box/File Drawer. Lock on file drawer secures both drawers. Upper storage cabinet with locking door and two adjustable laminate shelves inside. Door aligns with **29" H** surfaces. Shipped Fully Assembled.

PN69DBBFL	24 x 16 x 66	100	130	14.67	\$1329	N/A
PN69DBBFR	24 x 16 x 66	100	130	14.67	\$1329	N/A

Specify PN69DBBFL for **LEFT** or PN69DBBFR for **RIGHT**.

Box/Box/File Drawer. Lock on file drawer secures file and lower box drawer. Upper storage cabinet with locking door and two adjustable laminate shelves inside. Door aligns with **29" H** surfaces. Shipped Fully Assembled.

PN67DCSFL	24 x 16 x 66	100	150	17	\$1212	N/A
PN67DCSFR	24 x 16 x 66	100	150	17	\$1212	N/A

Specify PN67DCSFL for **LEFT** or PN67DCSFR for **RIGHT**.

Locking **file drawer** with **open shelf** above. Upper storage cabinet with locking door and two adjustable laminate shelves inside. Door aligns with **27" H** surfaces. Shipped Fully Assembled.

Required Specifications

- Top finish
- Base finish
- Drawer/door front finish

Optional Specifications

- No lock
- Glass shelf (where applicable)

66"H STORAGE CABINETS

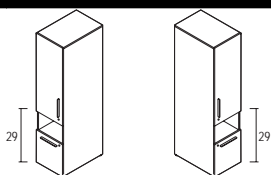

LEFT

RIGHT

66"H Storage Cabinet w/Large Shelf, File and Door at 29"H

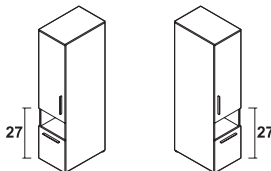

LEFT

RIGHT

66"H Recycling Cabinet w/Door at 27"H

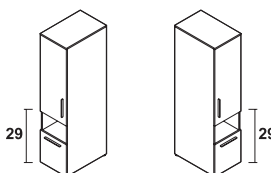

LEFT

RIGHT

66"H Recycling Cabinet w/Door at 29"H

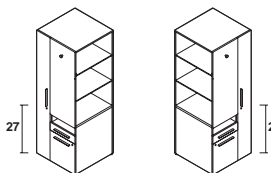

LEFT

RIGHT

66"H Storage Tower w/Wardrobe, Shelf, Box/File and Bookshelf at 27"H

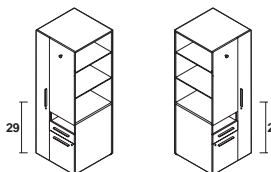

LEFT

RIGHT

66"H Storage Tower w/Wardrobe, Shelf, Box/File and Bookshelf at 29"H

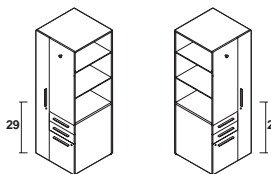

LEFT

RIGHT

66"H Storage Tower w/Wardrobe, Shelf, Box/Box/File and Bookshelf at 29"H

MODEL#	DIMENSIONS	FREIGHT CLASS	WT./LBS.	CUBIC FT.	LIST PRICE	GLASS SHELF ADD
	D x W x H					
PN69DCSFL	24 x 16 x 66	100	150	17	\$1212	N/A
PN69DCSFR	24 x 16 x 66	100	150	17	\$1212	N/A

Specify PN69DCSFL for **LEFT** or PN69DCSFR for **RIGHT**.

Locking **file drawer** with **open shelf** above. Upper storage cabinet with locking door and two adjustable laminate shelves inside. Door aligns with **29"H** surfaces. Shipped Fully Assembled.

PN67DRCSL	24 x 16 x 66	100	130	14.67	\$1136	N/A
PN67DRCSR	24 x 16 x 66	100	130	14.67	\$1136	N/A

Specify PN67DRCSL for **LEFT** or PN67DRCSR for **RIGHT**.

Upper storage cabinet with locking door and two adjustable laminate shelves inside. Drawer with one waste bin, one recycling bin, and an open shelf above. Door aligns with **27"H** surfaces. Shipped Fully Assembled.

PN69DRCSL	24 x 16 x 66	100	130	14.67	\$1197	N/A
PN69DRCSR	24 x 16 x 66	100	130	14.67	\$1197	N/A

Specify PN69DRCSL for **LEFT** or PN69DRCSR for **RIGHT**.

Upper storage cabinet with locking door and two adjustable laminate shelves inside. Drawer with one waste bin, one recycling bin, and an open shelf above. Door aligns with **29"H** surfaces. Shipped Fully Assembled.

PN67TSBFL	24 x 24 x 66	92.5	260	26	\$1794	\$139
PN67TSBFR	24 x 24 x 66	92.5	260	26	\$1794	\$139

Specify PN67TSBFL for **LEFT** or PN67TSBFR for **RIGHT**.

Open Shelf/Box/File drawer. Lock on file drawer secures both drawers. Two adjustable laminate shelves. Fixed bottom shelf aligns with **27"H** surfaces. Outside accessory hook and locking wardrobe with coat rail. Shipped Fully Assembled.

PN69TSBFL	24 x 24 x 66	92.5	260	26	\$1794	\$139
PN69TSBFR	24 x 24 x 66	92.5	260	26	\$1794	\$139

Specify PN69TSBFL for **LEFT** or PN69TSBFR for **RIGHT**.

Open Shelf/Box/File drawer. Lock on file drawer secures both drawers. Two adjustable laminate shelves. Fixed bottom shelf aligns with **29"H** surfaces. Outside accessory hook and locking wardrobe with coat rail. Shipped Fully Assembled.

PN69TBBFL	24 x 24 x 66	92.5	262	26	\$1889	\$139
PN69TBBFR	24 x 24 x 66	92.5	262	26	\$1889	\$139

Specify PN69TBBFL for **LEFT** or PN69TBBFR for **RIGHT**.

Box/Box/File drawer. Lock on file and lower box drawer. Two adjustable laminate shelves. Fixed bottom shelf aligns with **29"H** surfaces. Outside accessory hook and locking wardrobe with coat rail. Shipped Fully Assembled.

Required Specifications

Top finish
Base finish
Drawer/door front finish

Optional Specifications

No lock (where applicable)
Glass shelf (where applicable)

66" H STORAGE CABINETS

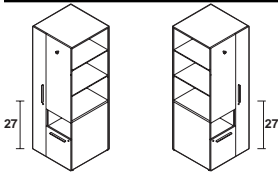

LEFT **RIGHT**
66" H Storage Tower w/Wardrobe, Shelf, File and Bookshelf at 27" H

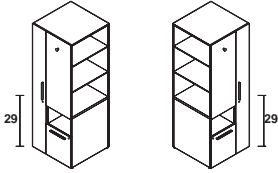

LEFT **RIGHT**
66" H Storage Tower w/Wardrobe, Shelf, File and Bookshelf at 29" H

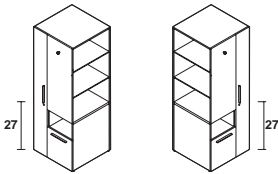

LEFT **RIGHT**
66" H Storage Tower w/Wardrobe, Shelf, Recycling and Bookshelf at 27" H

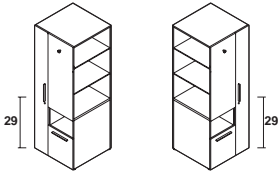

LEFT **RIGHT**
66" H Storage Tower w/Wardrobe, Shelf, Recycling and Bookshelf at 29" H

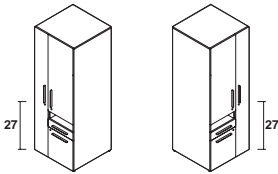

LEFT **RIGHT**
66" H Storage Tower w/Wardrobe, Shelf, Box/File and Door at 27" H

MODEL# DIMENSIONS FREIGHT CLASS WT/LBS. CUBIC FT. LIST PRICE GLASS SHELF ADD

	D x W x H					
PN67TSFL	24 x 24 x 66	92.5	260	26	\$1665	\$139
PN67TSFR	24 x 24 x 66	92.5	260	26	\$1665	\$139

Specify PN67TSFL for **LEFT** or PN67TSFR for **RIGHT**.

Locking **file drawer** with **open shelf** above. Two adjustable laminate shelves. Fixed bottom shelf aligns with **27" H** surfaces. Outside accessory hook. Locking wardrobe with coat rail. Shipped Fully Assembled.

PN69TSFL	24 x 24 x 66	92.5	260	26	\$1696	\$139
PN69TSFR	24 x 24 x 66	92.5	260	26	\$1696	\$139

Specify PN69TSFL for **LEFT** or PN69TSFR for **RIGHT**.

Locking **file drawer** with **open shelf** above. Two adjustable laminate shelves. Fixed bottom shelf aligns with **29" H** surfaces. Outside accessory hook. Locking wardrobe with coat rail. Shipped Fully Assembled.

PN67RTSL	24 x 24 x 66	92.5	260	26	\$1801	\$139
PN67RTSR	24 x 24 x 66	92.5	260	26	\$1801	\$139

Specify PN67RTSL for **LEFT** or PN67RTSR for **RIGHT**.

Drawer with one waste and one recycling bin. Open shelf above. Two adjustable laminate shelves. Fixed bottom shelf aligns with **27" H** surfaces. Outside accessory hook. Locking wardrobe with coat rail. Shipped Fully Assembled.

PN69RTSL	24 x 24 x 66	92.5	260	26	\$1801	\$139
PN69RTSR	24 x 24 x 66	92.5	260	26	\$1801	\$139

Specify PN69RTSL for **LEFT** or PN69RTSR for **RIGHT**.

Drawer with one waste and one recycling bin. Open shelf above. Two adjustable laminate shelves. Fixed bottom shelf aligns with **29" H** surfaces. Outside accessory hook. Locking wardrobe with coat rail. Shipped Fully Assembled.

PN67SBFTL	24 x 24 x 66	100	257	26	\$1860	N/A
PN67SBFTR	24 x 24 x 66	100	257	26	\$1860	N/A

Specify PN67SBFTL for **LEFT** or PN67SBFTR for **RIGHT**.

Open Shelf/Box/File Drawer. Lock on file drawer secures both drawers. Upper storage cabinet with locking door and two adjustable laminate shelves inside. Door aligns with **27" H** surfaces. Outside accessory hook. Locking wardrobe with coat rail. Shipped Fully Assembled.

Required Specifications

Top finish
 Base finish
 Drawer/door front finish

Optional Specifications

No lock (where applicable)
 Glass shelf (where applicable)

66" H STORAGE CABINETS

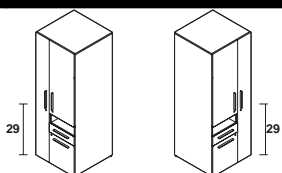

LEFT

RIGHT

66" H Storage Tower w/Wardrobe, Shelf, Box/File and Door at 29" H

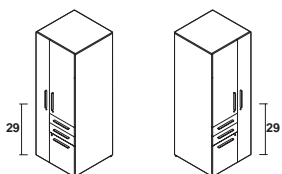

LEFT

RIGHT

66" H Storage Tower w/Wardrobe, Box/Box/File and Door at 29" H

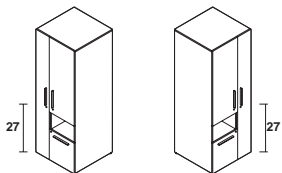

LEFT

RIGHT

66" H Storage Tower w/Wardrobe, Large Shelf, File and Door at 27" H

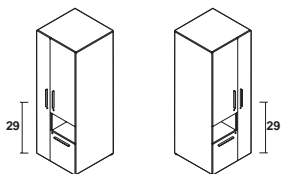

LEFT

RIGHT

66" H Storage Tower w/Wardrobe, Large Shelf, File and Door at 29" H

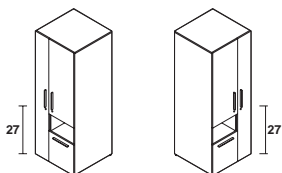

LEFT

RIGHT

66" H Storage Tower w/Wardrobe, Large Shelf, Recycling and Door at 27" H

MODEL#	DIMENSIONS	FREIGHT CLASS	WT/LBS.	CUBIC FT.	LIST PRICE	GLASS SHELF ADD
--------	------------	---------------	---------	-----------	------------	-----------------

D x W x H

PN69SBFTL	24 x 24 x 66	100	257	26	\$1860	N/A
PN69SBFTR	24 x 24 x 66	100	257	26	\$1860	N/A

Specify PN69SBFTL for **LEFT** or PN69SBFTR for **RIGHT**.

Open Shelf/Box/File Drawer. Lock on file drawer secures both drawers. Upper storage cabinet with locking door and two adjustable laminate shelves inside. Door aligns with **29" H** surfaces. Locking wardrobe with coat rail. Shipped Fully Assembled.

PN69BBFTL	24 x 24 x 66	100	257	26	\$1955	N/A
PN69BBFTR	24 x 24 x 66	100	257	26	\$1955	N/A

Specify PN69BBFTL for **LEFT** or PN69BBFTR for **RIGHT**.

Box/Box/File Drawer. Lock on file drawer secures file and lower box drawer. Upper storage cabinet with locking door and two adjustable laminate shelves inside. Door aligns with **29" H** surfaces. Locking wardrobe with coat rail. Shipped Fully Assembled.

PN67DTSFL	24 x 24 x 66	100	230	26	\$1783	N/A
PN67DTSFR	24 x 24 x 66	100	230	26	\$1783	N/A

Specify PN67DTSFL for **LEFT** or PN67DTSFR for **RIGHT**.

Locking **file drawer** with **open shelf** above. Upper storage cabinet with locking door and two adjustable laminate shelves inside. Door aligns with **27" H** surfaces. Locking wardrobe with coat rail. Shipped Fully Assembled.

PN69DTSFL	24 x 24 x 66	100	230	26	\$1783	N/A
PN69DTSFR	24 x 24 x 66	100	230	26	\$1783	N/A

Specify PN69DTSFL for **LEFT** or PN69DTSFR for **RIGHT**.

Locking **file drawer** with **open shelf** above. Upper storage cabinet with locking door and two adjustable laminate shelves inside. Door aligns with **29" H** surfaces. Locking wardrobe with coat rail. Shipped Fully Assembled.

PN67DRTSL	24 x 24 x 66	100	230	26	\$1906	N/A
PN67DRTSR	24 x 24 x 66	100	230	26	\$1906	N/A

Specify PN67DRTSL for **LEFT** or PN67DRTSR for **RIGHT**.

Drawer with one waste and one recycling bin. Open shelf above. Upper storage cabinet with locking door and two adjustable laminate shelves inside. Door aligns with **27" H** surfaces. Locking wardrobe with coat rail. Shipped Fully Assembled.

Required Specifications

Top finish
Base finish
Drawer/door front finish

Optional Specifications

No lock (where applicable)

66" H STORAGE CABINETS

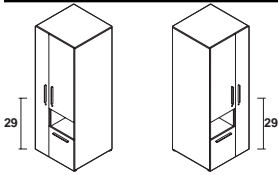

LEFT

RIGHT

66" H Storage Tower w/Wardrobe, Large Shelf, Recycling and Door at 29" H

MODEL#	DIMENSIONS	FREIGHT CLASS	WT/LBS.	CUBIC FT.	LIST PRICE	GLASS SHELF ADD
	D x W x H					
PN69DRTSL	24 x 24 x 66	100	230	26	\$1906	N/A
PN69DRTSR	24 x 24 x 66	100	230	26	\$1906	N/A

Specify PN69DRTSL for **LEFT** or PN69DRTSR for **RIGHT**.

Drawer with one waste and one recycling bin. Open shelf above. Upper storage cabinet with locking door and two adjustable laminate shelves inside. Door aligns with **29" H** surfaces. Locking wardrobe with coat rail. Shipped Fully Assembled.

MOBILE PEDESTALS

LIST PRICE HP ADD

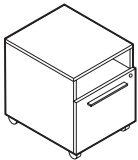

20" h Mobile Pedestal

PN21MSF	22 x 16 x 20	92.5	68	6	\$593	\$67
---------	--------------	------	----	---	--------------	-------------

Open Shelf/File drawer. Lock on file drawer. Front casters are locking. Shipped Fully Assembled.

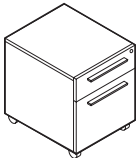

21" h Mobile Pedestal

PN22MBF	22 x 16 x 21	85	79	5.75	\$665	\$67
---------	--------------	----	----	------	--------------	-------------

Box/File drawer. Lock on box drawer secures both drawers. Front casters are locking. Shipped Fully Assembled.



26" h Mobile Pedestal

PN26MSBF	22 x 16 x 26	92.5	80	7	\$704	\$73
----------	--------------	------	----	---	--------------	-------------

Open Shelf/Box/File drawer. Lock on file drawer secures both drawers. Front casters are locking. Shipped Fully Assembled.



27" H Mobile Pedestal

PN27MBBF	22 x 16 x 27	92.5	95	8	\$743	\$88
----------	--------------	------	----	---	--------------	-------------

Box/Box/File drawer. Lock on file drawer secures file and lower box drawer. Front casters are locking. Shipped Fully Assembled.



27" H Mobile Pedestal

PN27MFF	22 x 16 x 27	85	101	8	\$727	\$82
---------	--------------	----	-----	---	--------------	-------------

File/File. Lock on lower file drawer secures both drawers. Front casters are locking. Shipped Fully Assembled.

Required Specifications

Top finish
Base finish (Pedestals)
Door/drawer front finish

Optional Specifications

No lock (where applicable)

CUSHIONS FOR MOBILE PEDESTALS

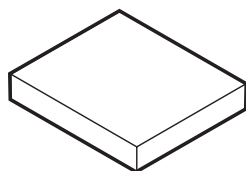

Pedestal Cushion*

MODEL#	DIMENSIONS	FREIGHT CLASS	WT/LBS.	CUBIC FT.	GRADE	LIST	GRADE	LIST
	D x W x H							
PN1622CU	21 x 16 x 2.5	125	6	.90	1	\$127	7	\$286
					2	\$151	8	\$353
					3	\$170	9	\$385
					4	\$198	10	\$446
					5	\$237	11	\$530
					6	\$252	12	\$634

For **PN21MSF** and **PN22MBF** mobile pedestals.

MOBILE LATERAL FILES

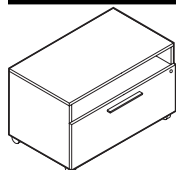

20" h Mobile Lateral File**

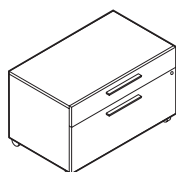

21" h Mobile Lateral File**

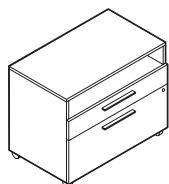

26" h Mobile Lateral File

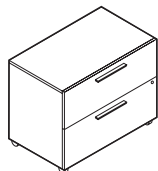

27" H Mobile Lateral File

						LIST PRICE	HP ADD
PN21MLSF	22 x 35.5 x 20	100	112	14		\$985	\$133

Open Shelf/File. File bars included for front-to-back letter and legal filing capability. Lock on file drawer. Front casters are locking. Shipped Fully Assembled. Can fit under 29"H and 27"H credenzas for mobile lateral file with or without a cushion. Can fit under 23"H credenzas without cushion only.

PN22MLBF	22 x 35.5 x 21	100	132	14		\$1049	\$142
----------	----------------	-----	-----	----	--	--------	-------

Box/File drawer. Lock on file drawer secures both drawers. File bars included for front-to-back letter and legal filing capability. Front casters are locking. Shipped Fully Assembled. Can fit under 29"H and 27"H credenzas for mobile lateral file with or without a cushion. Can fit under 23"H credenzas without cushion only.

PN26MLSBF	22 x 35.5 x 26	100	138	16		\$1098	\$149
-----------	----------------	-----	-----	----	--	--------	-------

Open Shelf/Box/File drawer. Lock on file drawer secures both drawers. File bars included for front-to-back letter and legal filing capability. Front casters are locking. Shipped Fully Assembled. Can fit under 29"H credenzas for mobile lateral file without cushion only.

PN27MLFF	22 x 35.5 x 27	92.5	170	16		\$1145	\$155
----------	----------------	------	-----	----	--	--------	-------

File/File drawer. Lock on bottom file drawer secures both drawers. File bars included for front-to-back letter and legal filing capability. Front casters are locking. Shipped Fully Assembled. Can fit under 29"H credenzas for mobile lateral file without cushion only.

Required Specifications
 Fabric*
 Top finish (Mobile Laterals)
 Base finish (Mobile Laterals)
 Door/drawer front finish (Mobile Laterals)

Optional Specifications
 No lock (Mobile Laterals)
 HP laminate (Mobile Laterals)

Accessories
 Cushion**

CUSHIONS FOR BENCHES

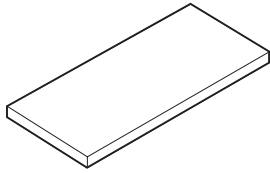

Mobile Lateral File Cushion**

MODEL #	DIMENSIONS D x W x H	FREIGHT CLASS	WT./LBS.	CUBIC FT.	GRADE	LIST	GRADE	LIST
PN3622CU	21 x 35.5 x 2.5	150	14	2.40	1	\$258	7	\$576
					2	\$305	8	\$709
					3	\$343	9	\$773
					4	\$399	10	\$896
					5	\$478	11	\$1064
					6	\$507	12	\$1273

For **PN21MLSF** and **PN22MLBF** mobile lateral files.

BENCHES

LIST PRICE

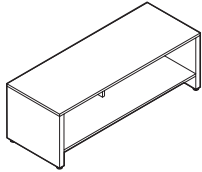

Bench w/Storage Shelf*

PN1836BN	18 x 36 x 17	150	64	9	\$476
PN1848BN	18 x 48 x 17	125	86	13	\$520

Open storage with recessed center divider. Shipped Fully Assembled.

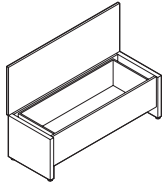

Bench w/Lateral File Storage*

PN1836BF	18 x 36 x 17	150	96	9	\$731
PN1848BF	18 x 48 x 17	100	108	13	\$784

Locking file bars included for front-to-back letter and legal filing capability. Shipped Fully Assembled. Locking.

CUSHIONS FOR BENCHES

GRADE LIST GRADE LIST

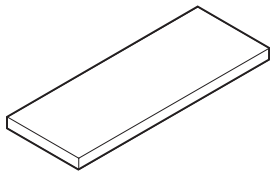

Bench Cushion**

PN1836CU	18 x 36 x 2.5	250	7	2	1	\$188	7	\$427
					2	\$223	8	\$526
					3	\$251	9	\$574
					4	\$293	10	\$666
					5	\$353	11	\$792
					6	\$375	12	\$948
PN1848CU	18 x 48 x 2.5	150	8	2	1	\$219	7	\$498
					2	\$260	8	\$614
					3	\$293	9	\$670
					4	\$342	10	\$778
					5	\$412	11	\$924
					6	\$437	12	\$1107

For **PN1836BN/BF** and **PN1848BN/BF** benches.

STOOLS

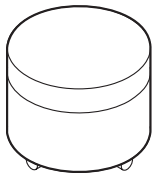

Round Mobile Stool w/Cushion**

PN1920ST	19 x 19 x 19.5	250	20	5.50	1	\$676	7	\$797
					2	\$695	8	\$847
					3	\$709	9	\$870
					4	\$730	10	\$917
					5	\$760	11	\$979
					6	\$771	12	\$1058

Laminate base. Shipped Fully Assembled. Cushion attached. Six casters.

• **NOTE: Maximum weight capacity is 200 lbs.**

Required Specifications

- Top finish*
- Base finish
- Fabric**

PLANTERS

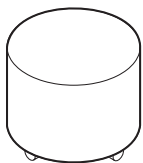

Round Mobile Table

MODEL#	DIMENSIONS	FREIGHT CLASS	WT./LBS.	CUBIC FT.	LIST PRICE	GLASS SHELF ADD
--------	------------	---------------	----------	-----------	------------	-----------------

D x W x H						
PN1915RT	19 x 19 x 14.5	150	16	3.03	\$515	--

Laminate finish. Fixed height. Shipped Fully Assembled. Six casters.

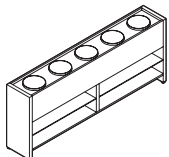

Five Pot Planter

PN7229PL	12 x 72 x 29	100	124	14.50	\$970	\$167
----------	--------------	-----	-----	-------	-------	-------

Five plastic pots - specify Black (BK) or White (WT). Adjustable 3 position laminate shelves. Shipped Fully Assembled.

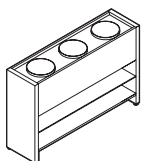

Three Pot Planter

PN4229PL	12 x 42 x 29	92.5	86	8.46	\$737	\$94
----------	--------------	------	----	------	-------	------

Three plastic pots - specify Black (BK) or White (WT). Adjustable 3 position laminate shelf. Shipped Fully Assembled.

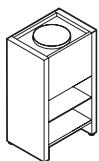

One Pot Planter

PN1529PL	12 x 15 x 29	85	65	5	\$516	\$56
----------	--------------	----	----	---	-------	------

1 plastic pot - specify Black (BK) or White (WT). Adjustable 3 position laminate shelf. Shipped Fully Assembled.

DIVIDER SHELVES

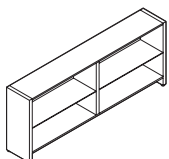

72" w Divider Shelf

PN7229BGS	12 x 72 x 29	125	124	18	\$801	\$94
-----------	--------------	-----	-----	----	-------	------

Adjustable 3 position laminate shelves. Shipped Fully Assembled.

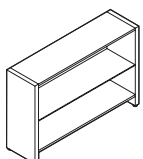

42" w Divider Shelf

PN4229BGS	12 x 42 x 29	125	86	11	\$646	\$167
-----------	--------------	-----	----	----	-------	-------

Adjustable 3 position laminate shelf. Shipped Fully Assembled.

Required Specifications

Planter pot finish
Top finish
Base finish

Optional Specifications

Glass shelf

BOOKSHELVES

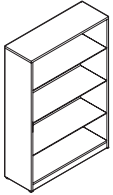

Bookshelf w/Laminate Shelves

MODEL#	DIMENSIONS D x W x H	FREIGHT CLASS	WT./LBS.	CUBIC FT.	LIST PRICE	HP ADD
PN2429BLS	12 x 24 x 29	70	37	2	\$492	\$77
PN2452BLS	12 x 24 x 52	70	60	3	\$624	N/A
PN2466BLS	12 x 24 x 66	70	74	4	\$685	N/A
PN3029BLS	12 x 30 x 29	70	44	2	\$553	\$89
PN3052BLS	12 x 30 x 52	65	68	3	\$647	N/A
PN3066BLS	12 x 30 x 66	70	79	4	\$714	N/A
PN3629BLS	12 x 36 x 29	70	66	3	\$595	\$95
PN3652BLS	12 x 36 x 52	70	80	4	\$682	N/A
PN3666BLS	12 x 36 x 66	70	106	5	\$750	N/A

66"H models have four adjustable shelves. 52"H models have 3 adjustable shelves. 29"H models have 1 adjustable shelf. Shipped Fully Assembled.

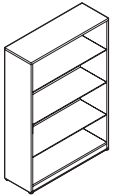

Bookshelf w/Glass Shelves

PN2429BGS	12 x 24 x 29	70	37	2	\$512	\$77
PN2452BGS	12 x 24 x 52	70	60	3	\$760	N/A
PN2466BGS	12 x 24 x 66	70	74	4	\$905	N/A
PN3029BGS	12 x 30 x 29	70	44	2	\$593	\$89
PN3052BGS	12 x 30 x 52	65	68	3	\$818	N/A
PN3066BGS	12 x 30 x 66	70	79	4	\$945	N/A
PN3629BGS	12 x 36 x 29	70	66	3	\$592	\$95
PN3652BGS	12 x 36 x 52	70	80	4	\$891	N/A
PN3666BGS	12 x 36 x 66	70	106	5	\$1046	N/A

66"H models have four adjustable shelves. 52"H models have 3 adjustable shelves. 29"H models have 1 adjustable shelf. Shipped Fully Assembled.

DESKTOP AND OVERHEAD STORAGE

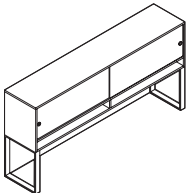

Hutch w/Laminate Doors*

PN3560LCH	16 x 60 x 35	125	131	18	\$1260
PN3566LCH	16 x 66 x 35	125	133	20	\$1282
PN3572LCH	16 x 72 x 35	125	135	21	\$1303
PN3578LCH	16 x 78 x 35	125	140	23	\$1373
PN3584LCH	16 x 84 x 35	150	145	25	\$1399

Sliding laminate doors in upper plastic track. Recessed brushed aluminum finger pulls. No lock. Tungsten (TUN) hutch supports. Laminate back board. 15.75" clearance between worksurface and underside. Shipped Partially Assembled.

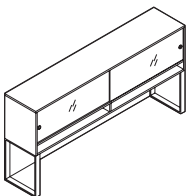

Hutch w/Glass Doors

PN3560CH	16 x 60 x 35	125	120	19.44	\$1830
PN3566CH	16 x 66 x 35	125	133	20	\$1886
PN3572CH	16 x 72 x 35	125	144	23.33	\$1967
PN3578CH	16 x 78 x 35	125	140	23	\$2060
PN3584CH	16 x 84 x 35	150	145	25	\$2160

Sliding glass doors in upper aluminum track. Satin etched 6mm glass. Brushed aluminum finger pulls. No lock. Tungsten (TUN) hutch supports. Laminate back board. 15.75" clearance between worksurface and underside. Shipped Partially Assembled.

Required Specifications

Top finish
Base finish
Door finish*

Optional Specifications

HP laminate (29"H bookshelves)

DESKTOP AND OVERHEAD STORAGE

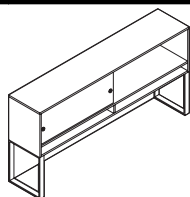

Hutch w/Single Laminate Door

MODEL# DIMENSIONS FREIGHT CLASS WT/LBS. CUBIC FT. LIST PRICE

D x W x H

PN3560LS	16 x 60 x 35	125	129	18	\$1220
PN3566LS	16 x 66 x 35	125	131	20	\$1245
PN3572LS	16 x 72 x 35	125	133	21	\$1265
PN3578LS	16 x 78 x 35	125	138	23	\$1318
PN3584LS	16 x 84 x 35	150	143	25	\$1358

Sliding laminate door in upper plastic track. Recessed brushed aluminum finger pulls. No lock. Tungsten (TU2) hutch supports. Laminate back board. 15.75" clearance between worksurface and underside. Shipped Partially Assembled.

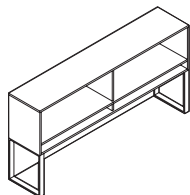

Open Hutch

PN3560CHO	16 x 60 x 35	125	124	18	\$1100
PN3566CHO	16 x 66 x 35	125	126	20	\$1119
PN3572CHO	16 x 72 x 35	125	128	21	\$1132
PN3578CHO	16 x 78 x 35	150	133	23	\$1184
PN3584CHO	16 x 84 x 35	150	138	25	\$1222

Tungsten (TU2) hutch supports. Laminate back board. 15.75" clearance between worksurface and underside. Shipped Partially Assembled.

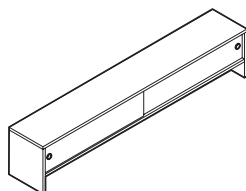

Desktop Storage w/Laminate Doors

PN1148LDS	11 x 48 x 12	100	46	5	\$611
PN1154LDS	11 x 54 x 12	100	48	6	\$626
PN1160LDS	11 x 60 x 12	100	54	6.50	\$660
PN1166LDS	11 x 66 x 12	100	58	7	\$685
PN1172LDS	11 x 72 x 12	100	62	7.75	\$711

Sliding laminate doors in upper plastic track. Recessed brushed aluminum finger pulls. No lock. Shipped Fully Assembled.

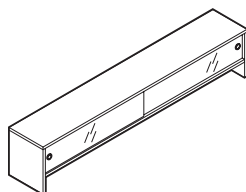

Desktop Storage w/Glass Doors

PN1148DS	11 x 48 x 12	100	48	5	\$968
PN1154DS	11 x 54 x 12	100	50	6	\$1023
PN1160DS	11 x 60 x 12	100	43	4.58	\$1062
PN1166DS	11 x 66 x 12	100	60	7	\$1106
PN1172DS	11 x 72 x 12	100	51	5.50	\$1197

Sliding glass doors in upper aluminum track. Satin etched 6mm glass. Recessed aluminum finger pulls. No lock. Shipped Fully Assembled.

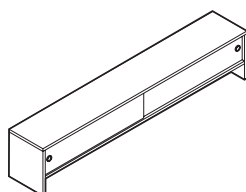

Desktop Storage w/Single Laminate Door

PN1148LS	11 x 48 x 12	100	44	5	\$547
PN1154LS	11 x 54 x 12	125	46	6	\$560
PN1160LS	11 x 60 x 12	100	52	6.50	\$590
PN1166LS	11 x 66 x 12	100	56	7	\$614
PN1172LS	11 x 72 x 12	125	60	7.75	\$647

Sliding laminate door in upper plastic track. Recessed brushed aluminum finger pulls. No lock. Shipped Fully Assembled.

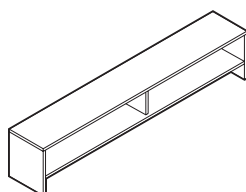

Open Desktop Storage

PN1148DSO	11 x 48 x 12	100	40	5	\$476
PN1154DSO	11 x 54 x 12	125	42	6	\$489
PN1160DSO	11 x 60 x 12	125	48	6.50	\$515
PN1166DSO	11 x 66 x 12	125	52	7	\$534
PN1172DSO	11 x 72 x 12	125	56	7.75	\$560

Open storage with center divider. Shipped Fully Assembled.

Required Specifications

- Top finish
- Base finish
- Door finish (laminated doors)

DESKTOP AND OVERHEAD STORAGE

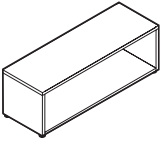

Desktop Shelf - One High

MODEL#	DIMENSIONS D x W x H	FREIGHT CLASS	WT/LBS.	CUBIC FT.	LIST PRICE
PN2413DB	12 x 24 x 13	70	31	1.50	\$252
PN3013DB	12 x 30 x 13	65	36	1.50	\$269
PN3613DB	12 x 36 x 13	65	38	1.50	\$271
PN4213DB	12 x 42 x 13	65	40	1.50	\$296
PN4813DB	12 x 48 x 13	70	42	2	\$305
PN5413DB	12 x 54 x 13	70	44	2	\$347
PN6013DB	12 x 60 x 13	65	47	2	\$368
PN6613DB	12 x 66 x 13	65	51	2	\$377
PN7213DB	12 x 72 x 13	65	55	2	\$380
PN7813DB	12 x 78 x 13	70	59	3	\$395

54", 60", 66", 72", 78"W with center divider. Shipped Fully Assembled.

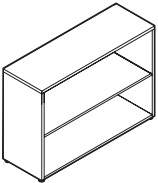

Desktop Shelf - Two High w/Laminate Shelf

PN2423LDB	12 x 24 x 23	60	45	1.50	\$312
PN3023LDB	12 x 30 x 23	60	49	1.50	\$340
PN3623LDB	12 x 36 x 23	65	53	2	\$344
PN2425LDB	12 x 24 x 25	60	47	1.50	\$312
PN3025LDB	12 x 30 x 25	65	51	2	\$340
PN3625LDB	12 x 36 x 25	65	55	2	\$344

One multiple-position adjustable laminate shelf. Shipped Fully Assembled.

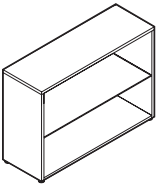

Desktop Shelf - Two High w/Glass Shelf

PN2423GDB	12 x 24 x 23	60	45	1.50	\$358
PN3023GDB	12 x 30 x 23	60	49	1.50	\$392
PN3623GDB	12 x 36 x 23	65	53	2	\$417
PN2425GDB	12 x 24 x 25	60	47	1.50	\$358
PN3025GDB	12 x 30 x 25	65	51	2	\$392
PN3625GDB	12 x 36 x 25	65	55	2	\$417

One multiple-position adjustable glass shelf. Shipped Fully Assembled.

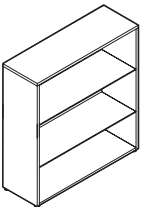

Desktop Shelf - Three High w/Laminate Shelves

PN2437LDB	12 x 24 x 37	65	58	2	\$389
PN3037LDB	12 x 30 x 37	70	64	3	\$414
PN3637LDB	12 x 36 x 37	65	71	3	\$431
PN2439LDB	12 x 24 x 39	65	58	2	\$389
PN3039LDB	12 x 30 x 39	70	64	3	\$414
PN3639LDB	12 x 36 x 39	65	71	3	\$431

Two multiple-position adjustable laminate shelves. Shipped Fully Assembled.

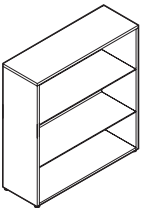

Desktop Shelf - Three High w/Glass Shelves

PN2437GDB	12 x 24 x 37	65	58	2	\$502
PN3037GDB	12 x 30 x 37	70	64	3	\$556
PN3637GDB	12 x 36 x 37	65	71	3	\$579
PN2439GDB	12 x 24 x 39	65	58	2	\$502
PN3039GDB	12 x 30 x 39	70	64	3	\$556
PN3639GDB	12 x 36 x 39	65	71	3	\$579

Two multiple-position adjustable glass shelves. Shipped Fully Assembled.

Required Specifications

Top finish
Base finish

DESKTOP AND OVERHEAD STORAGE

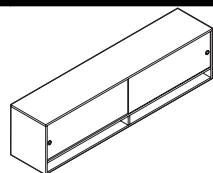

Large Overhead Storage w/Laminate Doors, Wall-Mounted

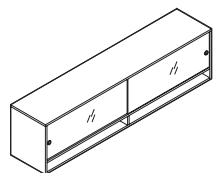

Large Overhead Storage w/Glass Doors Wall-Mounted

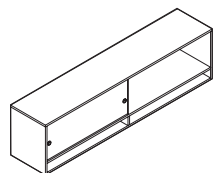

Large Overhead Storage w/Single Laminate Door, Wall-Mounted

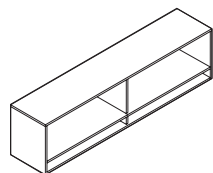

Large Overhead Storage, Wall-Mounted

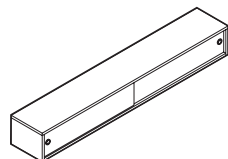

Small Overhead Storage w/Laminate Doors, Wall-Mounted

MODEL#	DIMENSIONS	FREIGHT CLASS	WT/LBS.	CUBIC FT.	LIST PRICE
--------	------------	---------------	---------	-----------	------------

D x W x H

PN1960LWH	16 x 60 x 19	100	119	13.25	\$929
PN1966LWH	16 x 66 x 19	100	130	14	\$951
PN1972LWH	16 x 72 x 19	100	138	16	\$971
PN1978LWH	16 x 78 x 19	100	148	17.50	\$1029
PN1984LWH	16 x 84 x 19	100	158	19	\$1068

Sliding laminate doors in upper plastic track. Recessed brushed aluminum finger pulls. No lock. Shipped Fully Assembled.

• **NOTE:** Care should be taken to mount the units. Units should be mounted to wall studs using correct fasteners. Failure to do so may result in collapse of the unit and subsequent personal injury. **Mounting hardware not included.** Mounting hardware used should be based on wall material. Consult an installation professional for proper wall mounting.

PN1960WH	16 x 60 x 19	100	101	10.56	\$1450
PN1966WH	16 x 66 x 19	100	130	14	\$1531
PN1972WH	16 x 72 x 19	100	121	12.67	\$1626
PN1978WH	16 x 78 x 19	100	148	17.50	\$1714
PN1984WH	16 x 84 x 19	100	158	19	\$1782

Sliding glass doors in upper aluminum track. Satin etched 6mm glass. Brushed aluminum finger pulls. No lock. Shipped Fully Assembled.

• **NOTE:** Care should be taken to mount the units. Units should be mounted to wall studs using correct fasteners. Failure to do so may result in collapse of the unit and subsequent personal injury. **Mounting hardware not included.** Mounting hardware used should be based on wall material. Consult an installation professional for proper wall mounting.

PN1960LS	16 x 60 x 19	100	117	13.25	\$864
PN1966LS	16 x 66 x 19	100	128	14	\$888
PN1972LS	16 x 72 x 19	100	136	16	\$908
PN1978LS	16 x 78 x 19	100	146	17.50	\$959
PN1984LS	16 x 84 x 19	100	156	19	\$998

Sliding laminate door in upper plastic track. Recessed brushed aluminum finger pulls. No lock. Shipped Fully Assembled.

• **NOTE:** Care should be taken to mount the units. Units should be mounted to wall studs using correct fasteners. Failure to do so may result in collapse of the unit and subsequent personal injury. **Mounting hardware not included.** Mounting hardware used should be based on wall material. Consult an installation professional for proper wall mounting.

PN1960WHO	16 x 60 x 19	100	112	13.25	\$782
PN1966WHO	16 x 66 x 19	100	123	14	\$801
PN1972WHO	16 x 72 x 19	100	131	16	\$814
PN1978WHO	16 x 78 x 19	100	141	17.50	\$865
PN1984WHO	16 x 84 x 19	125	151	19	\$904

Open storage with center divider. Shipped Fully Assembled.

• **NOTE:** Care should be taken to mount the units. Units should be mounted to wall studs using correct fasteners. Failure to do so may result in collapse of the unit and subsequent personal injury. **Mounting hardware not included.** Mounting hardware used should be based on wall material. Consult an installation professional for proper wall mounting.

PN1260LWH	12 x 60 x 8	100	49	5.25	\$681
PN1266LWH	12 x 66 x 8	100	53	6	\$704
PN1272LWH	12 x 72 x 8	100	56	6.25	\$737
PN1278LWH	12 x 78 x 8	100	60	7	\$762
PN1284LWH	12 x 84 x 8	100	64	8	\$775

Sliding laminate doors in upper plastic track. Recessed brushed aluminum finger pulls. No lock. Shipped Fully Assembled.

• **NOTE:** Care should be taken to mount the units. Units should be mounted to wall studs using correct fasteners. Failure to do so may result in collapse of the unit and subsequent personal injury. **Mounting hardware not included.** Mounting hardware used should be based on wall material. Consult an installation professional for proper wall mounting.

Required Specifications

- Top finish
- Base finish
- Door finish (laminate doors)

DESKTOP AND OVERHEAD STORAGE

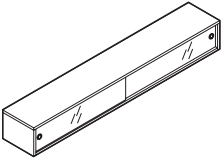

Small Overhead Storage w/Glass Doors Wall-Mounted

MODEL#	DIMENSIONS D x W x H	FREIGHT CLASS	WT/LBS.	CUBIC FT.	LIST PRICE
PN1260WH	12 x 60 x 8	100	31	3.33	\$1333
PN1266WH	12 x 66 x 8	100	53	6	\$1418
PN1272WH	12 x 72 x 8	100	38	4	\$1502
PN1278WH	12 x 78 x 8	100	60	7	\$1502
PN1284WH	12 x 84 x 8	100	64	8	\$1588

Sliding glass doors in upper aluminum track. Satin etched 6mm glass. Brushed aluminum finger pulls. No lock. Shipped Fully Assembled.

• **NOTE:** Care should be taken to mount the units. Units should be mounted to wall studs using correct fasteners. Failure to do so may result in collapse of the unit and subsequent personal injury. **Mounting hardware not included.** Mounting hardware used should be based on wall material. Consult an installation professional for proper wall mounting.

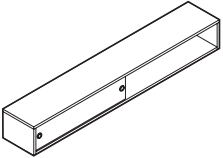

Small Overhead Storage w/Single Laminate Door, Wall-Mounted

PN1260LS	12 x 60 x 8	100	47	5.25	\$616
PN1266LS	12 x 66 x 8	100	51	6	\$640
PN1272LS	12 x 72 x 8	100	54	6.25	\$673
PN1278LS	12 x 78 x 8	100	58	7	\$712
PN1284LS	12 x 84 x 8	125	62	8	\$731

Sliding laminate door in upper plastic track. Recessed brushed aluminum finger pulls. No lock. Shipped Fully Assembled.

• **NOTE:** Care should be taken to mount the units. Units should be mounted to wall studs using correct fasteners. Failure to do so may result in collapse of the unit and subsequent personal injury. **Mounting hardware not included.** Mounting hardware used should be based on wall material. Consult an installation professional for proper wall mounting.

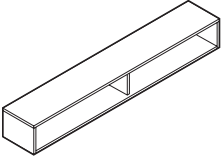

Small Overhead Storage, Wall-Mounted

PN1260WHO	12 x 60 x 8	100	45	5.25	\$521
PN1266WHO	12 x 66 x 8	100	49	6	\$553
PN1272WHO	12 x 72 x 8	100	52	6.25	\$586
PN1278WHO	12 x 78 x 8	100	56	7	\$618
PN1284WHO	12 x 84 x 8	125	60	8	\$637

Open storage shelf with center divider. Shipped Fully Assembled.

• **NOTE:** Care should be taken to mount the units. Units should be mounted to wall studs using correct fasteners. Failure to do so may result in collapse of the unit and subsequent personal injury. **Mounting hardware not included.** Mounting hardware used should be based on wall material. Consult an installation professional for proper wall mounting.

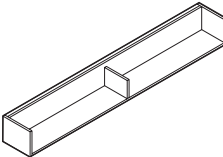

Wall-Mounted Shelf

PN1260WHS	12 x 60 x 8	150	31	5.50	\$386
PN1266WHS	12 x 66 x 8	150	34	6	\$406
PN1272WHS	12 x 72 x 8	125	37	6	\$418
PN1278WHS	12 x 78 x 8	125	40	6.50	\$431
PN1284WHS	12 x 84 x 8	125	44	7	\$451

Open storage shelf with center divider. Shipped Fully Assembled.

• **NOTE:** Care should be taken to mount the units. Units should be mounted to wall studs using correct fasteners. Failure to do so may result in collapse of the unit and subsequent personal injury. **Mounting hardware not included.** Mounting hardware used should be based on wall material. Consult an installation professional for proper wall mounting.

Required Specifications

- Top finish
- Base finish
- Door finish (laminated doors)

TACKBOARDS

MODEL# DIMENSIONS FREIGHT CLASS WT./LBS. CUBIC FT. FABRIC GRD. LIST PRICE

D x W x H

TACKBOARD Notes: Tackboards can be upholstered in all of the following fabrics:

Grade 1: Agate II, Drama, Jenny, Pebbles, Quilt, Sprinkle, Station, Urban

Grade 2: Couture, Crescent, Cumulus, Imprint, Lola, Match, Oxygen, Quantum, Renewal, Replay, Silhouette

Grade 3: Brinx, Mariposa

Grade 4: Accent

Grade 5: Meander, Tracery, Universe

PN1556TBH	1 x 56 x 14.5	100	9.50	1	1	\$388
					2	\$466
					3	\$559
					4	\$670
					5	\$771
PN1562TBH	.62 x 62 x 14.4	125	7.75	1	1	\$478
					2	\$574
					3	\$688
					4	\$826
					5	\$950
PN1568TBH	1 x 68 x 14.5	92.5	11	1	1	\$405
					2	\$486
					3	\$583
					4	\$699
					5	\$804
PN1574TBH	.62 x 74 x 14.4	125	9	1.50	1	\$611
					2	\$733
					3	\$880
					4	\$1056
					5	\$1215
PN1580TBH	1 x 80 x 14.5	125	10	1.50	1	\$645
					2	\$774
					3	\$928
					4	\$1114
					5	\$1282

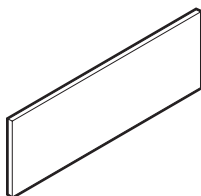

Tackboard for Hutches

Attaches with Velcro to Hutch backboard.

Required Specifications

Fabric

TACKBOARDS

MODEL# DIMENSIONS FREIGHT CLASS WT/LBS. CUBIC FT. FABRIC GRD. LIST PRICE

	D x W x H					
PN1560TBW	1 x 60 x 14.5	85	14	1	1	\$398
					2	\$477
					3	\$572
					4	\$687
					5	\$791
PN1566TBW	.62 x 66 x 14.4	85	12	1	1	\$532
					2	\$638
					3	\$766
					4	\$919
					5	\$1057
PN1572TBW	1 x 72 x 14.5	70	16.50	1	1	\$465
					2	\$558
					3	\$669
					4	\$803
					5	\$924
PN1578TBW	.62 x 78 x 14.4	100	14	1.50	1	\$669
					2	\$803
					3	\$963
					4	\$1156
					5	\$1330
PN1584TBW	.62 x 84 x 14.4	92.5	15	1.50	1	\$729
					2	\$875
					3	\$1049
					4	\$1259
					5	\$1448

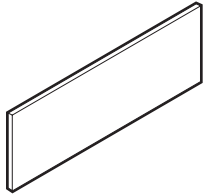

Tackboard for Overhead Storage

Attaches with adhesive-backed Velcro.

Required Specifications
Fabric

ELECTRICAL / DATA

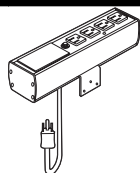

4 Outlet, 1 Telecom Blank Plate

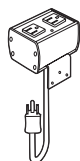

2 Outlet Power Block

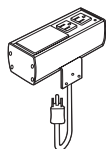

2 Outlet, 1 Telecom Blank Plate

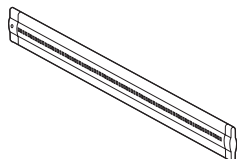

LED Task Light

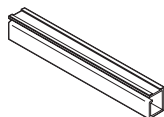

Wire Manager

MODEL#	DIMENSIONS	FREIGHT CLASS	WT/LBS.	CUBIC FT.	LIST PRICE
--------	------------	---------------	---------	-----------	------------

D x W x H

PGDPS41	2.5 x 10.25 x 2.22	70	1.50	.02	\$183
---------	--------------------	----	------	-----	--------------

4 power receptacles and 1 telecom blank plate. For mounting behind pull-out shelf or open space credenza. Tungsten (TUN) finish. 12 foot black cord.

PGDPS20	2.5 x 3.58 x 2.22	70	1	.01	\$131
---------	-------------------	----	---	-----	--------------

2 power receptacles. For side mounted installation. Tungsten (TUN) finish. 12 foot black cord.

PGDPS21	2.5 x 6.75 x 2.22	70	1.25	.01	\$169
---------	-------------------	----	------	-----	--------------

2 power receptacles and 1 telecom blank plate. For side mounted installation. Tungsten (TUN) finish. 12 foot black cord.

PLED30	1.5 x 15.5 x .5	150	2	.50	\$358
PLED50	1.5 x 23.5 x .5	150	2	.50	\$412
PLED100	1.5 x 43.5 x .5	125	3	.50	\$478

Energy efficient LED. Ultra slim design. Suitable for hanging under Hutch or Wallhung units. 6' power cord.

PEWM5.5	2 x 66 x 2	70	.60	.10	\$142
PEWM5	2 x 60 x 2	70	.60	.10	\$119
PEWM4.5	2 x 54 x 2	70	.50	.10	\$106
PEWM4	2 x 48 x 2	70	.50	.10	\$96
PEWM3.5	2 x 42 x 2	70	.40	.10	\$83
PEWM3	2 x 36 x 2	70	.40	.10	\$73
PEWM2.5	2 x 30 x 2	70	.30	.10	\$60
PEWM2	2 x 24 x 2	70	.30	.10	\$50
PEWM1.5	2 x 18 x 2	70	.20	.10	\$37
PEWM1	2 x 12 x 2	70	.20	.10	\$27

Plastic tray flexes to receive and hold electrical and data wires. Quickly attaches with two strips of double-sided tape. Black (BLK) only.

ACCESSORIES

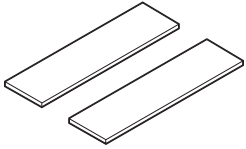

**Keyboard Tray Kit for Double Rail
Keyboard Tray**

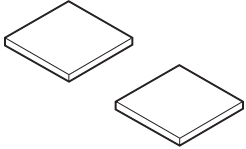

**Keyboard Tray Kit for Single Rail
Keyboard Tray**

MODEL#	DIMENSIONS	FREIGHT CLASS	WT/LBS.	CUBIC FT.	LIST PRICE
--------	------------	---------------	---------	-----------	------------

	D x W x H				
PNDKK30	8 x 30 x .75	70	9	.50	\$163

For use with worksurfaces that require support channel(s). To allow installation of **double rail** keyboard tray under support channels. Black laminate with Self edge. 2 per package.

PNSKK8	8 x 8 x .75	65	6	.25	\$86
--------	-------------	----	---	-----	-------------

For use with worksurfaces that require support channel(s). To allow installation of **single rail** keyboard tray under support channel. Black laminate with self edge. 2 per package.

TABLES

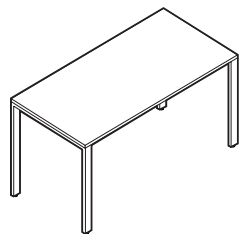

29" H Table

MODEL#	DIMENSIONS	FREIGHT CLASS	WT/LBS.	CUBIC FT.	LIST PRICE	HP ADD
D x W x H						
PN242429	24 x 24 x 29	150	53	10	\$706	\$97
PN482429	24 x 48 x 29	125	71	10.50	\$754	\$104
PN542429	24 x 54 x 29	125	83	13	\$895	\$124
PN602429	24 x 60 x 29	125	86	13	\$911	\$126
PN662429	24 x 66 x 29	125	90	14	\$930	\$128
PN722429	24 x 72 x 29	150	97	21	\$936	\$129
PN782429	24 x 78 x 29	150	101	21	\$1026	\$142
PN842429	24 x 84 x 29	150	106	22	\$1109	\$153
PN902429	24 x 90 x 29	150	110	23	\$1165	\$161
PN962429	24 x 96 x 29	150	123	24	\$1207	\$166
PN303029	30 x 30 x 29	150	66	12	\$778	\$107
PN483029	30 x 48 x 29	150	77	13	\$828	\$114
PN543029	30 x 54 x 29	150	94	16	\$975	\$134
PN603029	30 x 60 x 29	125	99	16.50	\$982	\$135
PN663029	30 x 66 x 29	125	105	17	\$1010	\$139
PN723029	30 x 72 x 29	150	112	23	\$1026	\$142
PN783029	30 x 78 x 29	150	119	26	\$1121	\$155
PN843029	30 x 84 x 29	150	132	27	\$1203	\$166
PN903029	30 x 90 x 29	150	139	33	\$1259	\$174
PN963029	30 x 96 x 29	150	143	29.50	\$1289	\$178
PN363629	36 x 36 x 29	150	80	15	\$827	\$114
PN603629	36 x 60 x 29	150	113	20	\$1128	\$155
PN663629	36 x 66 x 29	150	119	21	\$1164	\$160
PN723629	36 x 72 x 29	150	128	29	\$1182	\$163
PN783629	36 x 78 x 29	150	135	31	\$1165	\$161
PN843629	36 x 84 x 29	150	150	32	\$1248	\$172
PN903629	36 x 90 x 29	150	161	33.50	\$1340	\$185
PN963629	36 x 96 x 29	150	164	35	\$1353	\$186
PN424229	42 x 42 x 29	150	96	17	\$954	\$132
PN604229	42 x 60 x 29	150	125	22	\$1179	\$163
PN664229	42 x 66 x 29	150	134	23	\$1216	\$168
PN724229	42 x 72 x 29	150	142	32	\$1240	\$171
PN784229	42 x 78 x 29	150	150	35	\$1379	\$190
PN844229	42 x 84 x 29	150	167	36	\$1503	\$207
PN904229	42 x 90 x 29	150	176	38	\$1611	\$222
PN964229	42 x 96 x 29	150	182	40	\$1643	\$226
PN484829	48 x 48 x 29	150	114	21	\$985	\$136
PN604829	48 x 60 x 29	150	138	26	\$1222	\$168
PN664829	48 x 66 x 29	150	147	27	\$1264	\$174
PN724829	48 x 72 x 29	150	158	38	\$1282	\$177
PN784829	48 x 78 x 29	150	166	40	\$1449	\$200
PN844829	48 x 84 x 29	150	184	42	\$1572	\$217
PN904829	48 x 90 x 29	150	193	43	\$1680	\$231
PN964829	48 x 96 x 29	150	202	45	\$1706	\$235

Freestanding. 1" x 2.5" open metal frame legs with levelers, finished in Tungsten (TUN), Designer White (DWT) or Black (BLK). Metal support hat channel(s) provided on tables exceeding 54" in width. Shipped in 2 cartons.

Required Specifications

Top finish
Leg finish

Optional Specifications

HP laminate

Accessories

Wire manager
Desktop screen

TABLES

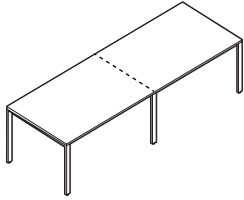

29" H Table with Center Leg

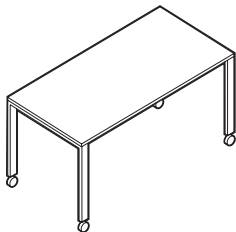

29" H Table with Casters

MODEL#	DIMENSIONS D x W x H	FREIGHT CLASS	WT./LBS.	CUBIC FT.	LIST PRICE	HP ADD
PN1202429	24 x 120 x 29	250	169	61.38	\$1660	\$229
PN1442429	24 x 144 x 29	250	198	67.37	\$1740	\$240
PN1203029	30 x 120 x 29	250	194	74.85	\$1798	\$248
PN1443029	30 x 144 x 29	250	220	82.34	\$1869	\$257
PN1203629	36 x 120 x 29	250	221	86.83	\$2064	\$284
PN1443629	36 x 144 x 29	250	246	97.31	\$2185	\$301
PN1204229	42 x 120 x 29	250	246	101.8	\$2146	\$295
PN1444229	42 x 144 x 29	250	287	110.7	\$2264	\$312
PN1204829	48 x 120 x 29	250	271	113.7	\$2273	\$313
PN1444829	48 x 144 x 29	250	291	116.7	\$2391	\$329

Freestanding. 1" x 2.5" open metal frame legs with levelers, finished in Tungsten (TUN), Designer White (DWT) or Black (BLK). 120" and 144"W with 2 piece top. Metal support hat channel(s) provided on tables exceeding 54" in width. Shipped in 3 cartons.

PN242429C	24 x 24 x 29	150	53	9	\$729	\$101
PN482429C	24 x 48 x 29	125	71	10.50	\$774	\$107
PN542429C	24 x 54 x 29	125	83	13	\$928	\$128
PN602429C	24 x 60 x 29	125	86	13	\$945	\$130
PN662429C	24 x 66 x 29	125	90	14	\$962	\$133
PN722429C	24 x 72 x 29	125	97	14	\$977	\$135
PN303029C	30 x 30 x 29	150	66	12	\$802	\$111
PN483029C	48 x 48 x 29	150	77	19	\$848	\$117
PN543029C	30 x 54 x 29	150	94	16	\$1008	\$139
PN603029C	30 x 60 x 29	125	99	16.50	\$1016	\$140
PN663029C	30 x 66 x 29	125	105	17	\$1038	\$143
PN723029C	30 x 72 x 29	125	112	18	\$1074	\$148
PN363629C	36 x 36 x 29	150	80	15	\$843	\$116
PN603629C	36 x 60 x 29	150	113	20	\$1065	\$147
PN663629C	36 x 66 x 29	150	119	21	\$1091	\$150
PN723629C	36 x 72 x 29	150	124	29	\$1248	\$172
PN424229C	42 x 42 x 29	150	96	17	\$976	\$135
PN484829C	48 x 48 x 29	150	114	21	\$1011	\$139

Freestanding. 1" x 2.5" open metal frame legs with casters, finished in Tungsten (TUN), Designer White (DWT) or Black (BLK). All casters are locking. Metal support hat channel(s) provided on tables exceeding 54" in width. Shipped in 2 cartons.

Required Specifications

Top finish
Leg finish

Optional Specifications

HP laminate

Accessories

Wire manager
Desktop screen



Zira™ is a contemporary desking solution with extensive options to personalize your workspace. Components can be freestanding for single workstation configurations, or joined together to form multiple work groups. Create a work environment that meets your worksurface needs and storage requirements - then go ahead and personalize it!

Select from the following: hundreds of components for any size or shape office, storage components that can tower to 84" high, 17 laminate finishes, 5 edge options, 9 handle options in silver, black, nickel or brass finishes, 2 glazing options with 2 frame finishes on doors and modesty panels, and lastly, work surface grommets and power blocks for your electrical needs.

Zira is your most functional solution to work environment efficiency and organization.



Tops are available in a choice of 1" or 1 ½" thick with a variety of edge details and a top over side, edge panel design
* Shown with 1.5" thick top and Bicut Edge (CR).



Optional Frosted or Ribbed glazing on Doors and Modesty Panels. Available with Silver or Black frames.



Collator option is available for the convenient storage of day-to-day documents. Available in Black or Brushed Cobalt finish.



Features and Benefits

- 45 lb. density particle board substructure with high performance thermally fused laminate
- Top over side panel design
- Worksurfaces feature preferred edging in matching color
- Available in 1" or 1.5" thick top with a variety of edge details
- 11/16" thick full modesty panel is standard
- 11/16" thick ¾ modesty panel available on most components
- 75 lb box - 150 lb. file drawer weight capacity with full height sides with pencil tray included in box drawer
- Lateral file drawers can accommodate legal or letter documents
- Premium full extension progressive ball bearing slides on file drawers & box drawers
- All drawer fronts edge banded with side pull opening pedestals and standard pedestal locks
- Compatible with GPS II, e0+ and Divide partitioning systems for increased privacy and storage requirements

GENERAL INFORMATION

- Over 5300 different standard components are available
- Handles, Lock Finish and Trim Color (if applicable) **MUST MATCH**
- Dimensionally compatible with the Adaptabilities and Correlation series.
- Global laminate and seating products are in compliance with stringent emission guidelines set out by the Greenguard Environmental Institute under the standards for low emitting products and materials. www.greenguard.org
- **Level 3 Certified**

WORKSURFACES

- Available in 1" or 1.5" thick thermally fused laminate tops with a variety of edge details
- Tops are sealed with Global's preferred edge in matching color
- Woodgrain surfaces feature edging with matching printed woodgrain
- High Pressure Tops are available in all Zira laminate finishes at an extended lead time. Please see model # for pricing and availability

CONSTRUCTION

- Constructed of 45 lb. density particleboard with high performance thermally fused laminate
- All desks are size (incrementally) accurate
- Desk drawers open with side pulls and feature a French dovetail joint in front, lap joint in back. Pulls are available for these units at an upcharge, see below. All other drawers/storage feature built-in pulls available in 9 different styles
- Virtually no loose hardware
- Models with Monopost are standard with 4" Square Monopost. Optional 5" Round and 4" Round Monopost are available at no upcharge. Available in Black (**BLK**) or Silver (**SIL**) finish. Please Specify
- Leveling glides are standard on all floor units
- Premium full extension progressive ball bearing slides on file drawers & box drawers
- All drawer fronts edge banded with side pull opening pedestals and standard pedestal locks

MODESTY PANELS

- Laminate Full modesty panel is standard. Laminate 3/4 modesty panel is available at no additional charge. Please Specify "3MP"
- Glazing Options are available on both the Full Modesty Panel and 3/4 Modesty Panel. Please Specify. See next page for options and codes
- 11/16" thick full modesty panel is standard
- 11/16" thick ¾ modesty panel available on most components
- **Note:** Woodgrain modesty panels over 60" wide will have the grain pattern in the horizontal direction. All end panels and modesty panels 60" or less will have the grain pattern in the vertical direction

STORAGE

- All lateral files feature a foolproof interlock device
- 75 lb box - 150 lb. file drawer weight capacity with full height sides with pencil tray included in box drawer
- Lateral file drawers can accommodate legal or letter documents
- All drawers are locking unless otherwise noted
- Front-to-back filing bars for all steel drawer files available separately. Order FBB bars. See page 565 for pricing
- **All shelves are 3 position fixed/height adjustable**

LOCKS

- Locks are standard on all storage modules. Finish will coordinate with handles and/or aluminum doors. For desk, return or table components, etc. please specify finish: Black (**BK**) or Silver (**SI**).

SHIPPING

- Shipped assembled, 1 per carton, unless otherwise noted. Other components are easy to assemble

CUSTOM WIDTHS

- Custom widths are available for products that feature a worksurface as follows: desks, credenzas (applies to kneespace and single pedestal credenzas only), islands (excludes spanner islands), returns, bridges, extended corners and corners.
- Desks and credenzas that incorporate drawers and/or doors will be modified by changing the width of the worksurface and modesty panel, drawer and/or door dimensions are not affected.
- Upcharge for custom width is next size up plus 5%. Example: Z4268EDML Extended Corner Island - use Z4272EDML (\$915 list price) plus 5%. This also applies to Zira tackboards.
- No upcharge for next size up
- Custom width does not apply to cabinets, hutches, pedestals or any other units. Please visit the Global Dealer Center and click on "Specials" on the left sidebar to submit your request.

HUTCHES

- 71" hutches are for use when a hutch is placed across the back of a 42" wide return and across the depth of a 29.63" (30") deep surface top

1. SPECIFY MODEL NUMBER

2. SPECIFY FINISH AND TOP THICKNESS/EDGE DETAIL

- All units available in solid color (Top and Chassis matching) or Two-Tone combination except for the following units:
 - Shells: One Tone in all standard finishes
 - Collators: One Tone in Black (K) or Brushed Cobalt (T)
 - Horizontal Pigeon Holes: One Tone in all standard finishes
 - Vertical and Transitional Pigeon Holes: Two-Tone - Chassis/Shell in all standard finishes, Collator Shelves in Black (K) or Brushed Cobalt (T).

Finishes:

ACJ	Absolute Acajou	ASN	Asian Night
AWC	Avant Cherry	AWH	Avant Honey
BLK	Black	BRC	Brushed Cobalt
CSJ	Constellation Java	DES	Dark Espresso
HGT	Hayden Grey	QTM	Quartered Mahogany
SKC	Shaker Cherry	SOG	Storm Grey
TFW	Tiger Fruitwood	TMA	Tiger Mahogany
TMP	Tiger Maple	TWL	Tiger Walnut
WHT	White	WHC	White Chocolate*
WGY	Willow Grey	WCR	Winter Cherry

**textured, HP non-textured, top only*

Top Thickness/Edge Detail

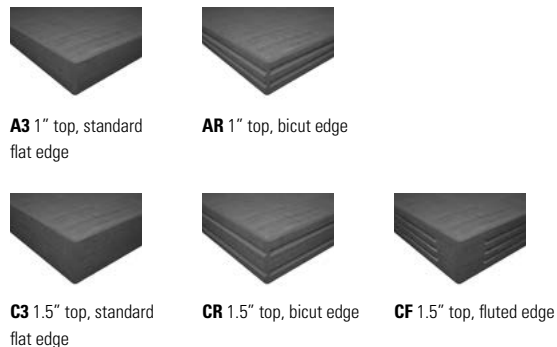

3. SPECIFY OPTIONS

BOX DRAWERS (No Upcharge)

- Specify **B_** (Drawer Position 1-4 must be specified)

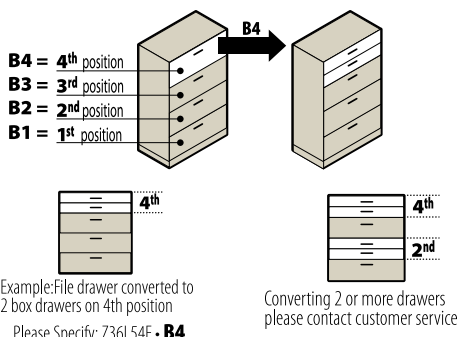

- *Not available on drawers with steel interiors*

HANDLES

• Handles are standard on most drawers/storage modules. All other Zira drawers, including mobile and hanging pedestals, can be ordered with a choice of nine handle options to be **factory installed**. Each handle is identified by the letters "HU", "HV", "HW", "HX", "HS", "HZ", "HO", "HQ", and "HR". To specify a handle, please specify the code after the model number. To order a handle as an option, please specify the code when ordering, List Price is **\$35**.



MONOPOST

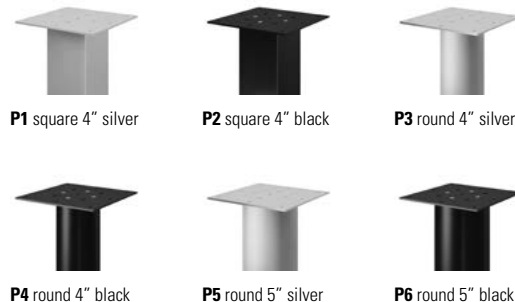

GROMMETS

- Additional grommets available in standard worksurface locations (left, center or right).
- Order as: **AG1, AG2 or AG3. Add \$65**

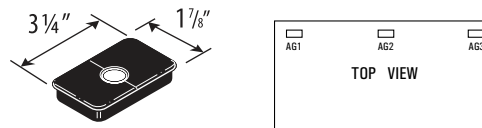

- Grommet hole dimensions are 3 1/4" wide x 1 7/8" deep.
- Actual grommet locations on the worksurface are depicted in the example drawings shown below. Dimensions shown are actual measurements (in inches).

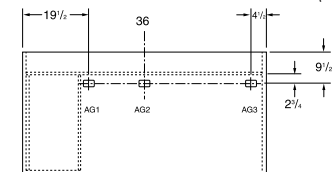

36 x 72 single pedestal left desks (3672F3L)

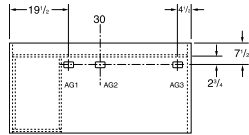

30 x 60 single pedestal left desks (3060F3L)

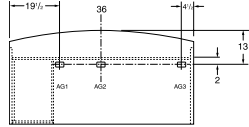

36 x 72 single pedestal left bow top desks (3672FB3L)

- Grommets may be placed at non-standard locations. Order as: **AGS - Add \$65**. A drawing must be supplied with vertical and horizontal dimensions to the center of the cut-out (as in drawing above). Please refer to **CUSTOM GROMMET LOCATION FORM** in the back reference section.
- Components that come standard with grommet may be ordered without a grommet. **Add \$35**.
- Grommets are available on modesty panels of **extended corners** and **5-sided corners** 8" in where the two modesty panels meet at a 90° angle. Please specify **FOGMP-R** for right grommet placement and **FOGMP-L** for left grommet (placement is as shown on diagrams below). Cost is **\$65**.
**Modesty Panels are 1" off of ground

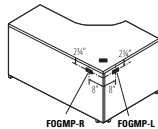

Left Extended Corner Unit

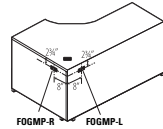

Right Extended Corner Unit

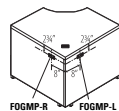

5-Sided Corner Unit

POWER BLOCK

- A Power Block (model **PMSPPDM**) may be ordered on all worksurfaces.
- A Power Block is a rectangular worksurface power/data module with one electrical duplex receptacle and two data (RJ45) receptacles. 9 foot black cord included. Power Block dimensions are 3 1/2" deep x 6 1/2" wide x 2 3/4" high.
- To purchase a Power Block, you must specify both the Power Block cut-out location and the Power Block model #. Order Power Block as **PMSPPDM**, **Add \$238**. Power Blocks are available in standard worksurface locations (left, center or right). Order as E1, E2 or E3. **Add \$65**.



Power Block **PMSPPDM** Add **\$238**

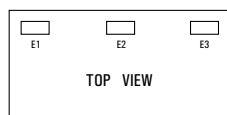

Specify location **E1, E2 or E3** Add **\$65**

GLAZING (Doors and Modesty Panels)



Z1 Frosted Glazing, Silver Frame



Z2 Frosted Glazing, Black Frame



Z3 Ribbed Glazing, Silver Frame

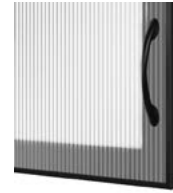

Z4 Ribbed Glazing, Black Frame



Full modesty panel - **Z1** Frosted Glazing, Silver Frame
3/4 Modesty (Shown) - **Z1 + 3MP**



Full modesty panel - **Z2** Frosted Glazing, Black Frame
3/4 Modesty (Shown) - **Z2 + 3MP**



Full modesty panel - **Z3** Ribbed Glazing, Silver Frame
3/4 Modesty (Shown) - **Z3 + 3MP**



Full modesty panel - **Z4** Ribbed Glazing, Black Frame
3/4 Modesty (Shown) - **Z4 + 3MP**

Desks / Extended Corner Desks - available width: 60", 66", 72" 84"

Modesty Treatments

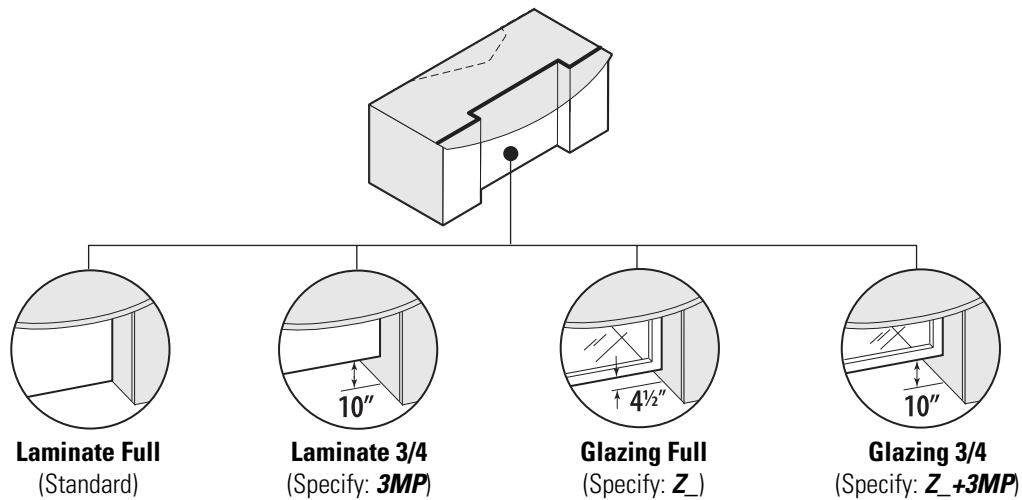

Overhang Dimensions



Returns - available width: 36", 42", 48", 54", 60", 66", 72"

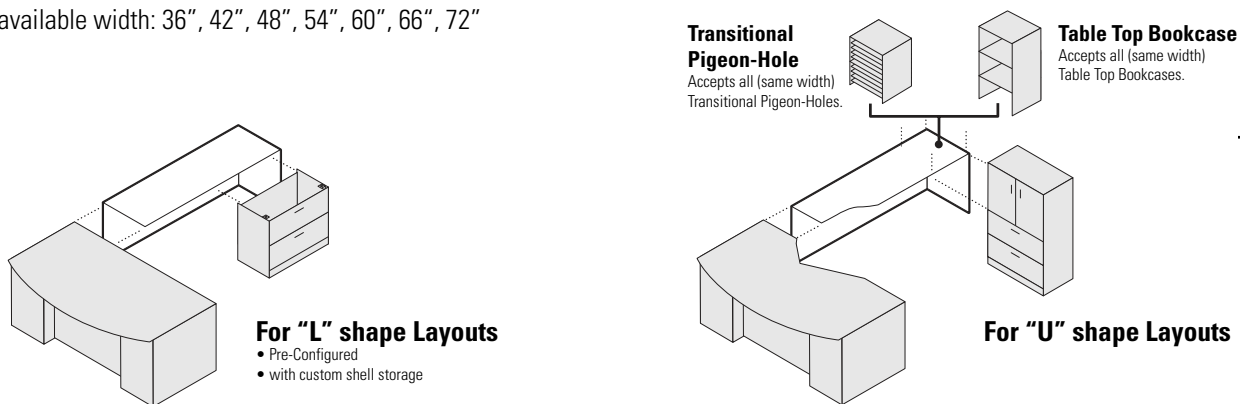

Bridges - available width: 42", 48"

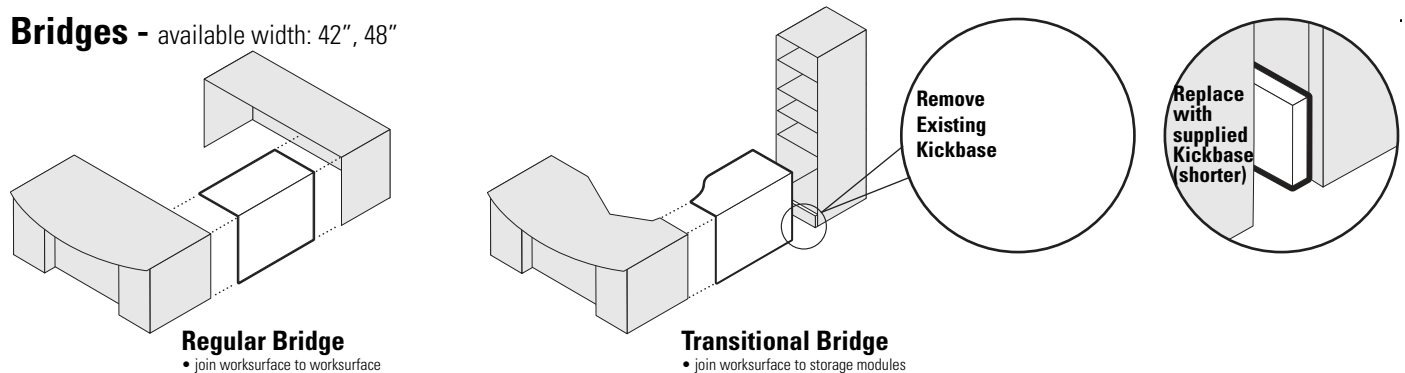

Extended Corners - available widths: 60", 66", 72", 84"

Modesty Treatments

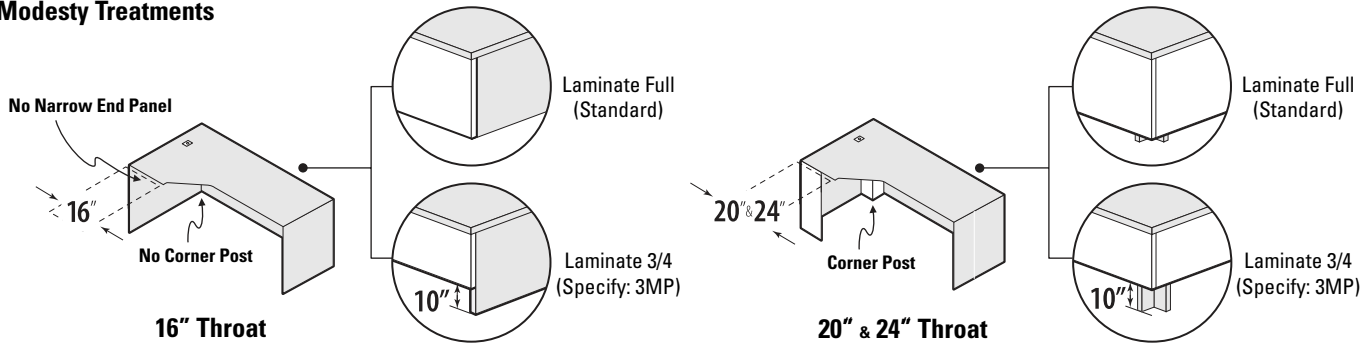

Extended Corner Islands - available width: 60", 66", 72" 84"

Modesty Treatments

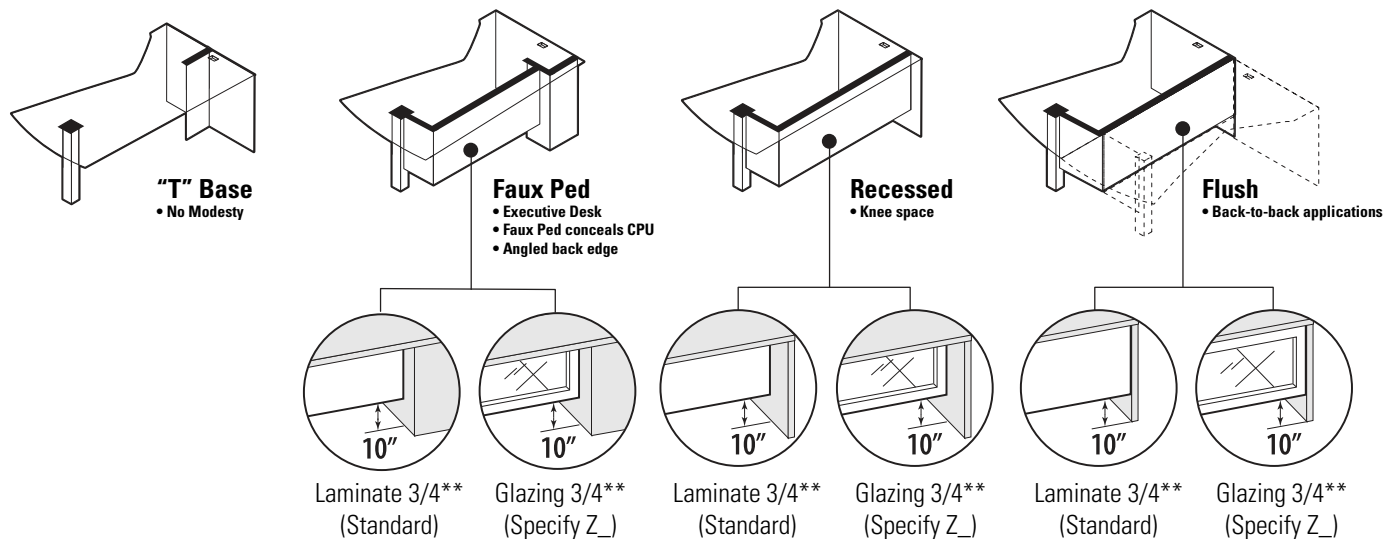

** Full modesty not available

Overhang Dimensions



Shells - available width: 12", 15", 16", 18", 21", 30", 36"
 For Extended Corners, Space Saver Returns and Connectables

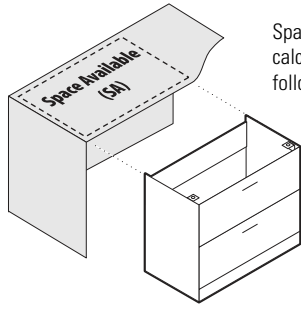

Space Available can be calculated with the following formulas:

Space Saver Returns

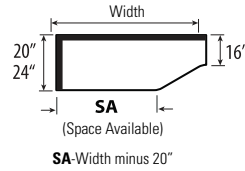

Space Saver Connectables

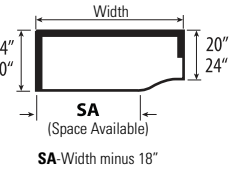

Extended Corners

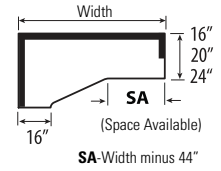
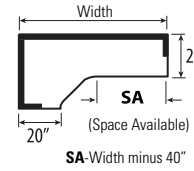
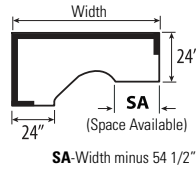

Storage

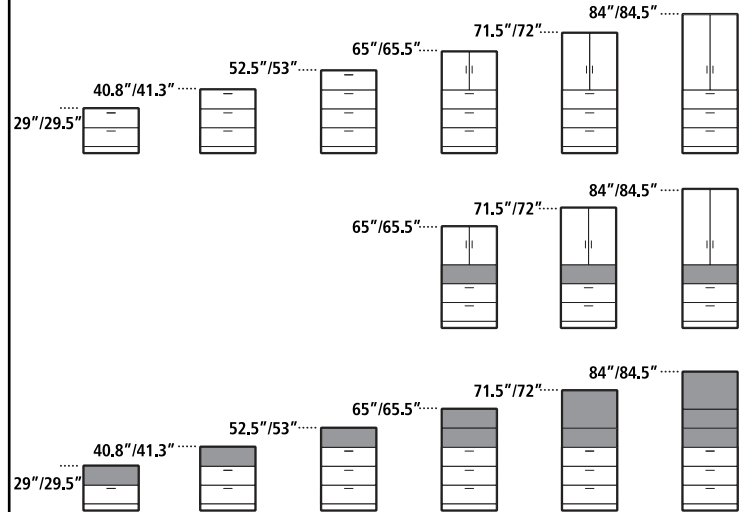
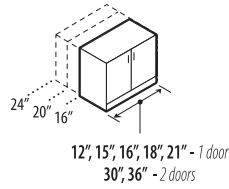
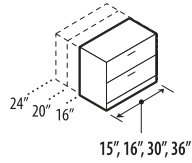
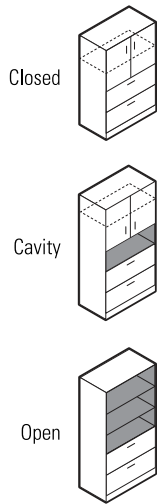

Wardrobe & Personal Towers

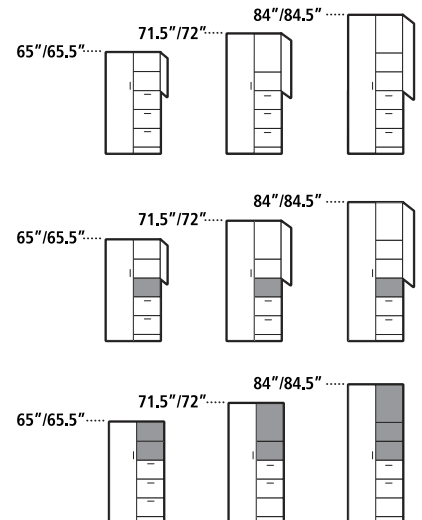
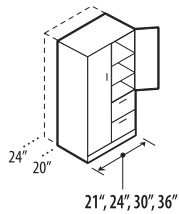
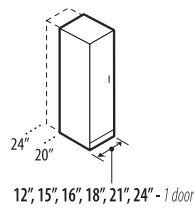
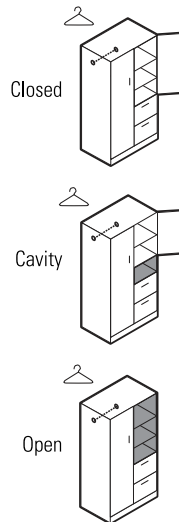

PC Support

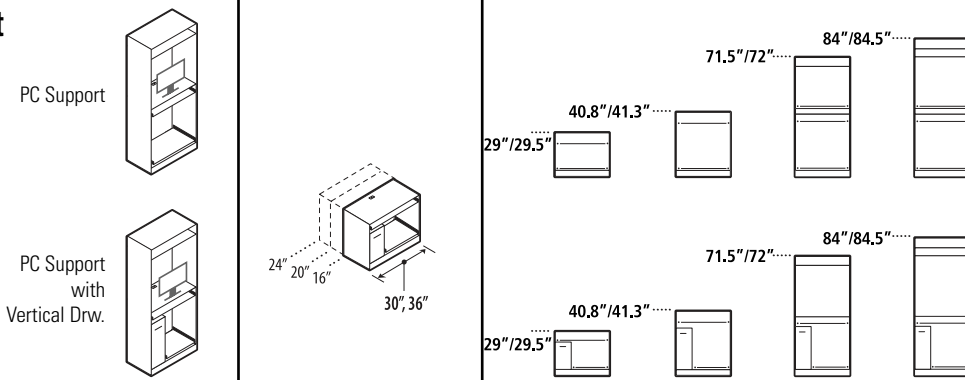

Vertical Utility Drawer

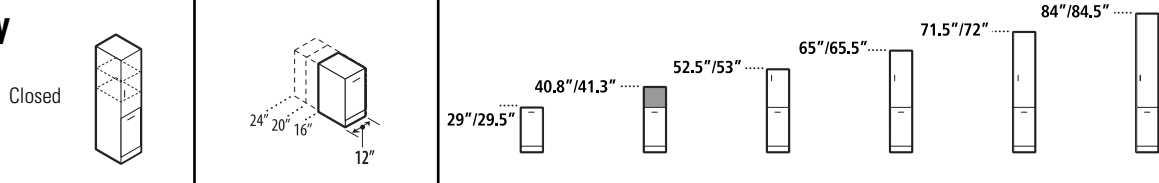

Drawer & Cavity Positions

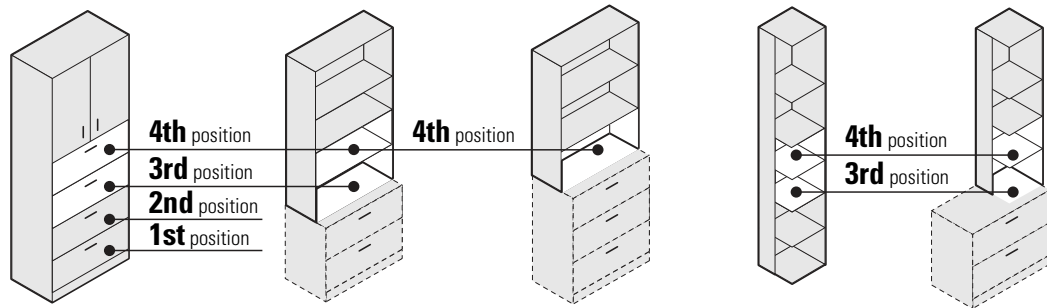

Box Drawer Option

File drawers can be converted to box/box drawers in any of the four standard positions

- B1** = 2 box drawers on 1st position
- B2** = 2 box drawers on 2nd position
- B3** = 2 box drawers on 3rd position
- B4** = 2 box drawers on 4th position

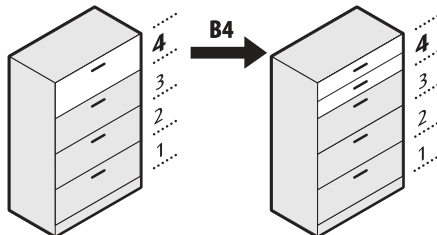

Example
File drawer converted to 2 box drawers on 4th position

Please specify: Z36L54F - **B4**

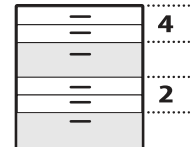

Converting 2 or more drawers please contact customer service.

Collator Positions

All storage units can be specified with an optional collator on 2nd, 3rd and/or 4th position.

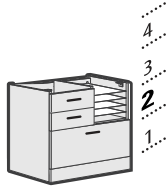

Collator on 2nd position
Specify: 2K - Black or 2T - Brushed Cobalt

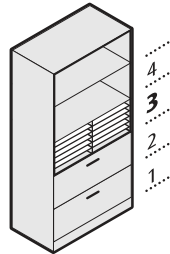

Collator on 3rd position
Specify: 3K - Black or 3T - Brushed Cobalt

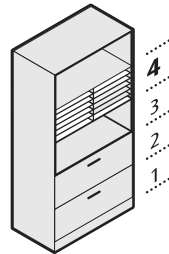

Collator on 4th position
Specify: 4K - Black or 4T - Brushed Cobalt

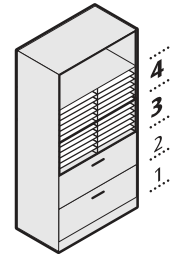

Collator on 3rd & 4th positions
Specify: 7K - Black or 7T - Brushed Cobalt

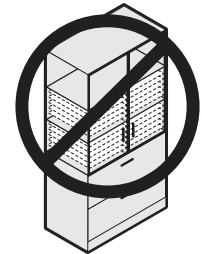

Collators do not fit behind doors

For 2K / 2T, 3K / 3T OR 4K / 4T.....Add \$168

For 7K / 7T.....Add \$336

Glazing

Glazing is available in the following options:

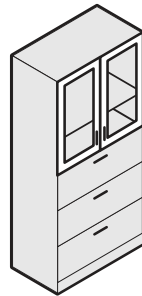

Silver Frame
Frosted Glazing
Z1

Please specify:
Z36L73F - **Z1**

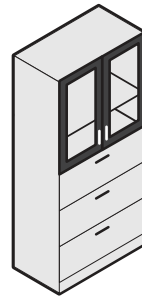

Black Frame
Frosted Glazing
Z2

Please specify:
Z36L73F - **Z2**

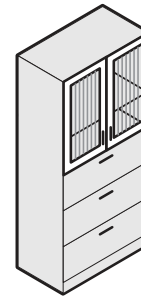

Silver Frame
Ribbed Glazing
Z3

Please specify:
Z36L73F - **Z3**

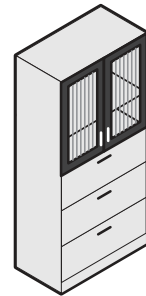

Black Frame
Ribbed Glazing
Z4

Please specify:
Z36L73F - **Z4**

Filing Options For Lateral Filing Components

On 16" deep files, drawer interiors are only 13" deep. On 20" and 24" deep files, drawer interiors are 16" deep.

Side-To-Side

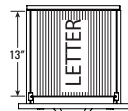

15" Wide - 16" Depth

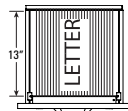

16" Wide - 16" Depth

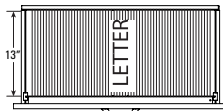

30" Wide - 16" Depth

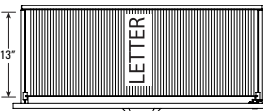

36" Wide - 16" Depth

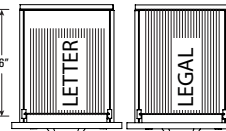

15" Wide - 20" and 24" Depth

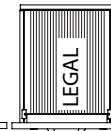

16" Wide - 20" and 24" Depth

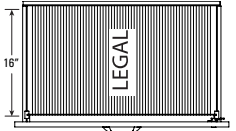

30" Wide - 20" and 24" Depth

Front-To-Back

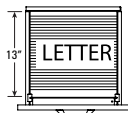

16" Wide - 16" Depth

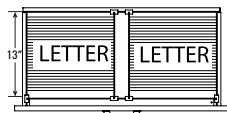

30" Wide - 16" Depth



30" Wide - 16" Depth

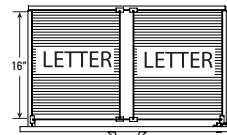

30" Wide - 20" and 24" Depth

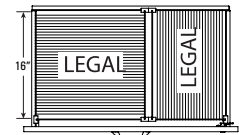

30" Wide - 20" and 24" Depth

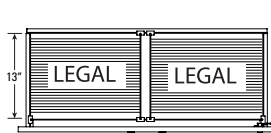

36" Wide - 16" Depth

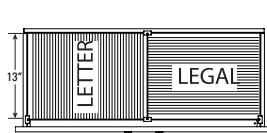

36" Wide - 16" Depth

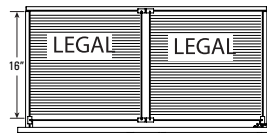

36" Wide - 20" and 24" Depth



36" Wide - 20" and 24" Depth

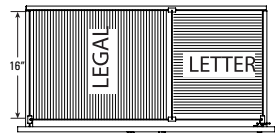

36" Wide - 20" and 24" Depth

Height Map

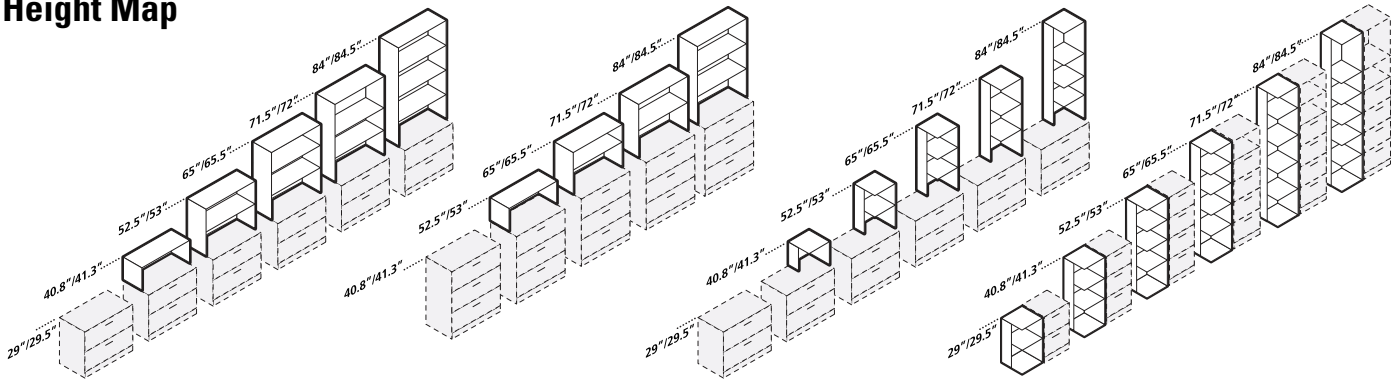

Drawer & Cavity Positions

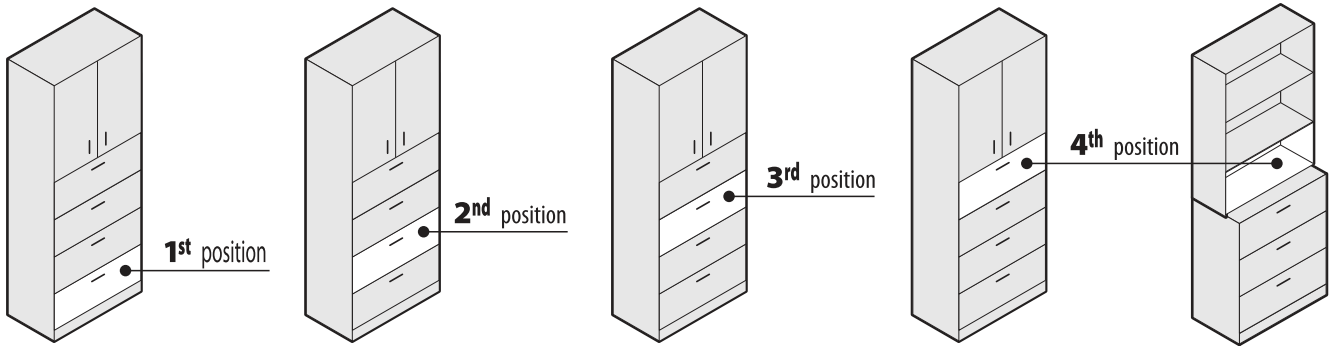

Collator Positions

For 12" to 21" wide units

**If no collator is desired, must specify when placing order.

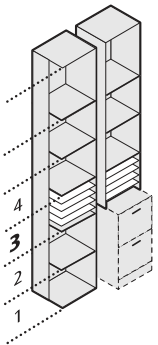

Collator on 3rd position
Specify: **3K - Black** or
3T - Brushed Cobalt

For 3K / 3T or 4K / 4T.....Add \$168

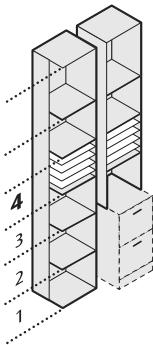

Collator on 4th position
Specify: **4K - Black** or
4T - Brushed Cobalt

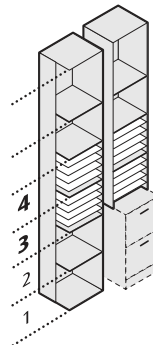

Collator on 3rd & 4th position
Specify: **7K - Black** or
7T - Brushed Cobalt

For 7K / 7T.....Add \$336

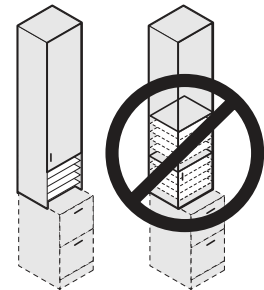

Collators do not fit behind door

Table Top Bookcase

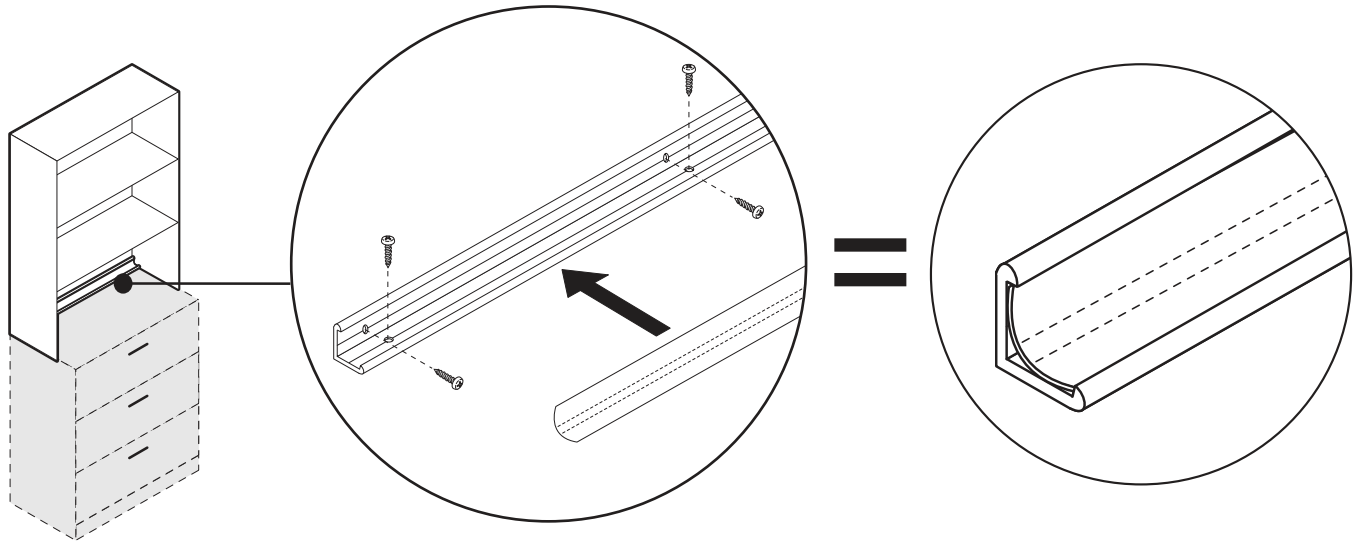

Hutches

Monitor clearance dimensions

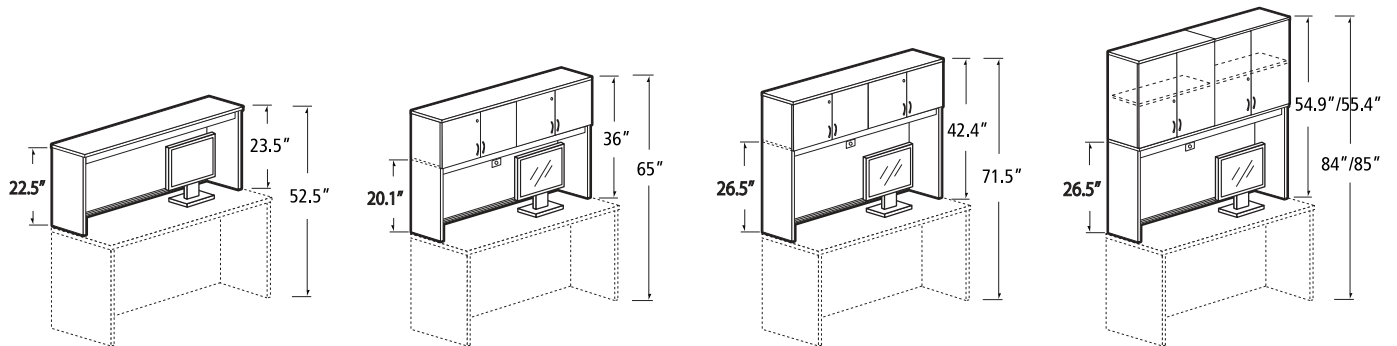

DOUBLE PEDESTAL DESKS

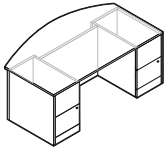

Double Pedestal Bow Top Desk

MODEL#	DIMENSIONS D x W x H	FREIGHT CLASS	WT/LBS.	CUBIC FT.	1" TOP	1.5" TOP	GLAZE ADD	HP ADD
Z4284FB22	42 x 84 x 29-29.5	250	381.15	34.25	\$2015	\$2240	\$648	\$717
Z4272FB22	42 x 72 x 29-29.5	125	377	59	\$1937	\$2133	\$536	\$538
Z3672FB22	36 x 72 x 29-29.5	125	317.10	50.75	\$1809	\$1982	\$536	\$404
Z3666FB22	36 x 66 x 29-29.5	125	305.55	46.75	\$1772	\$1933	\$479	\$404
Z3660FB22	36 x 60 x 29-29.5	125	295.05	42.50	\$1719	\$1866	\$423	\$336

Standard with **Freestanding** file/file pedestals on **left** and **right**. Pedestals lock. Bow top overhangs 2 ¼" at ends and 8" on center.

- 84" wide desks are shipped RTA (ready to assemble) in 3 cartons.

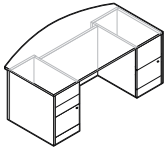

Double Pedestal Bow Top Desk

Z4284FB32	42 x 84 x 29-29.5	250	379.05	34.25	\$2041	\$2266	\$648	\$717
Z4272FB32	42 x 72 x 29-29.5	125	375	59	\$1963	\$2159	\$536	\$538
Z3672FB32	36 x 72 x 29-29.5	125	315	50.75	\$1833	\$2007	\$536	\$404
Z3666FB32	36 x 66 x 29-29.5	125	303.45	46.75	\$1797	\$1957	\$479	\$404
Z3660FB32	36 x 60 x 29-29.5	125	292.95	42.50	\$1747	\$1894	\$423	\$336

Standard with **Freestanding** file/file pedestal on **right** and box/box/file pedestal on **left**. File drawer and lower box drawer lock. Bow top overhangs 2 ¼" at ends and 8" on center.

- 84" wide desks are shipped RTA (ready to assemble) in 3 cartons.

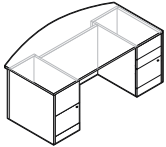

Double Pedestal Bow Top Desk

Z4284FB23	42 x 84 x 29-29.5	250	379.05	34.25	\$2041	\$2266	\$648	\$717
Z4272FB23	42 x 72 x 29-29.5	125	375	59	\$1963	\$2159	\$536	\$538
Z3672FB23	36 x 72 x 29-29.5	125	315	50.75	\$1833	\$2007	\$536	\$404
Z3666FB23	36 x 66 x 29-29.5	125	303.45	46.75	\$1797	\$1957	\$479	\$404
Z3660FB23	36 x 60 x 29-29.5	125	292.95	42.50	\$1747	\$1894	\$423	\$336

Standard with **Freestanding** file/file pedestal on **left** and box/box/file pedestal on **right**. File drawer and lower box drawer lock. Bow top overhangs 2 ¼" at ends and 8" on center.

- 84" wide desks are shipped RTA (ready to assemble) in 3 cartons.

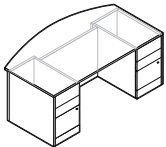

Double Pedestal Bow Top Desk

Z4284FB33	42 x 84 x 29-29.5	250	381.15	34.25	\$2067	\$2292	\$648	\$717
Z4272FB33	42 x 72 x 29-29.5	125	378	59	\$1988	\$2185	\$536	\$538
Z3672FB33	36 x 72 x 29-29.5	125	317.10	50.75	\$1859	\$2033	\$536	\$404
Z3666FB33	36 x 66 x 29-29.5	125	305.55	46.75	\$1823	\$1983	\$479	\$404
Z3660FB33	36 x 60 x 29-29.5	125	295.05	42.50	\$1777	\$1934	\$423	\$336

Standard with **Freestanding** box/box/file pedestals on **left** and **right**. File drawer and lower box drawer lock. Bow top overhangs 2 ¼" at ends and 8" on center.

- 84" wide desks are shipped RTA (ready to assemble) in 3 cartons.

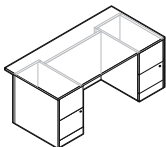

Double Pedestal Desk

Z4284F22	42 x 84 x 29-29.5	250	385.35	34.25	\$1944	\$2135	\$648	\$717
Z4272F22	42 x 72 x 29-29.5	125	373	59	\$1873	\$2037	\$536	\$538
Z3684F22	36 x 84 x 29-29.5	125	366.12	59	\$1831	\$1996	\$648	\$538
Z3672F22	36 x 72 x 29-29.5	125	326.01	50.75	\$1747	\$1890	\$536	\$404
Z3666F22	36 x 66 x 29-29.5	125	314.77	46.75	\$1714	\$1846	\$479	\$404
Z3660F22	36 x 60 x 29-29.5	125	294.93	42.50	\$1682	\$1802	\$423	\$336
Z3072F22	29.69 x 72 x 29-29.5	125	326.01	50.75	\$1747	\$1889	\$536	\$404
Z3066F22	29.69 x 66 x 29-29.5	125	314.77	46.75	\$1714	\$1845	\$479	\$404
Z3060F22	29.69 x 60 x 29-29.5	125	294.93	42.50	\$1682	\$1801	\$423	\$336

Standard with **Freestanding** file/file pedestals on **left** and **right**. Pedestals lock.

- 84" wide desks are shipped RTA (ready to assemble) in 3 cartons.

Required Specifications

Top finish
Top/edge detail
Base finish
Lock finish

Optional Specifications

HP laminate Handles
Key # Modesty finish glazed
Modesty type
Grommet position or power block cut-out

Accessories

Power block
Keyboard
Pencil drawer

DOUBLE PEDESTAL DESKS

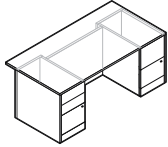

Double Pedestal Desk

MODEL#	DIMENSIONS D x W x H	FREIGHT CLASS	WT/LBS.	CUBIC FT.	1" TOP	1.5" TOP	GLAZE ADD	HP ADD
Z4284F32	42 x 84 x 29-29.5	250	383.25	34.25	\$1970	\$2159	\$648	\$717
Z4272F32	42 x 72 x 29-29.5	125	371	59	\$1899	\$2063	\$536	\$538
Z3684F32	36 x 84 x 29-29.5	125	364.54	59	\$1856	\$2021	\$648	\$538
Z3672F32	36 x 72 x 29-29.5	125	324.43	50.75	\$1773	\$1916	\$536	\$404
Z3666F32	36 x 66 x 29-29.5	125	313.18	46.75	\$1740	\$1872	\$479	\$404
Z3660F32	36 x 60 x 29-29.5	125	267.10	42.50	\$1707	\$1828	\$423	\$336
Z3072F32	29.69 x 72 x 29-29.5	125	324.43	50.75	\$1773	\$1916	\$536	\$404
Z3066F32	29.69 x 66 x 29-29.5	125	313.18	46.75	\$1740	\$1872	\$479	\$404
Z3060F32	29.69 x 60 x 29-29.5	125	267.10	42.50	\$1707	\$1827	\$423	\$336

Standard with **Freestanding** box/box/file pedestal on **left** and file/file pedestal on **right**. File drawer and lower box drawer lock.

- 84" wide desks are shipped RTA (ready to assemble) in 3 cartons.

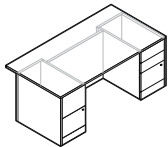

Double Pedestal Desk

Z4284F23	42 x 84 x 29-29.5	250	383.25	34.25	\$1970	\$2159	\$648	\$717
Z4272F23	42 x 72 x 29-29.5	125	371	59	\$1899	\$2063	\$536	\$538
Z3684F23	36 x 84 x 29-29.5	125	364.54	59	\$1856	\$2021	\$648	\$538
Z3672F23	36 x 72 x 29-29.5	125	324.43	50.75	\$1773	\$1916	\$536	\$404
Z3666F23	36 x 66 x 29-29.5	125	313.18	46.75	\$1740	\$1872	\$479	\$404
Z3660F23	36 x 60 x 29-29.5	125	267.10	42.50	\$1707	\$1828	\$423	\$336
Z3072F23	29.69 x 72 x 29-29.5	125	324.43	50.75	\$1773	\$1916	\$536	\$404
Z3066F23	29.69 x 66 x 29-29.5	125	313.18	46.75	\$1740	\$1872	\$479	\$404
Z3060F23	29.69 x 60 x 29-29.5	125	267.10	42.50	\$1707	\$1827	\$423	\$336

Standard with **Freestanding** file/file pedestal on **left** and box/box/file pedestal on **right**. File drawer and lower box drawer lock.

- 84" wide desks are shipped RTA (ready to assemble) in 3 cartons.

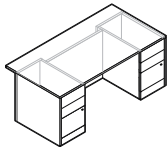

Double Pedestal Desk

Z4284F33	42 x 84 x 29-29.5	250	381.15	34.25	\$1997	\$2186	\$648	\$717
Z4272F33	42 x 72 x 29-29.5	125	370	59	\$1925	\$2088	\$536	\$538
Z3684F33	36 x 84 x 29-29.5	150	341.25	59	\$1882	\$2047	\$648	\$538
Z3672F33	36 x 72 x 29-29.5	125	316.05	50.75	\$1798	\$1941	\$536	\$404
Z3666F33	36 x 66 x 29-29.5	125	304.50	46.75	\$1766	\$1898	\$479	\$404
Z3660F33	36 x 60 x 29-29.5	125	261.45	42.50	\$1733	\$1854	\$423	\$336
Z3072F33	29.69 x 72 x 29-29.5	125	316.05	50.75	\$1798	\$1941	\$536	\$404
Z3066F33	29.69 x 66 x 29-29.5	125	304.50	46.75	\$1766	\$1894	\$479	\$404
Z3060F33	29.69 x 60 x 29-29.5	125	261.45	42.50	\$1733	\$1854	\$423	\$336

Standard with **Freestanding** box/box/file pedestals on **left** and **right**. File drawer and lower box drawer lock.

- 84" wide desks are shipped RTA (ready to assemble) in 3 cartons.

SINGLE PEDESTAL DESKS

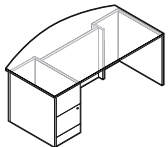

Single Pedestal Bow Top Desk - LEFT

Z4284FB2L	42 x 84 x 29-29.5	125	322.35	21.75	\$1541	\$1766	\$648	\$717
Z4272FB2L	42 x 72 x 29-29.5	150	315	59	\$1462	\$1659	\$536	\$538
Z3672FB2L	36 x 72 x 29-29.5	150	281.35	50.75	\$1356	\$1529	\$536	\$404
Z3666FB2L	36 x 66 x 29-29.5	150	274.68	46.75	\$1319	\$1480	\$479	\$404
Z3660FB2L	36 x 60 x 29-29.5	125	259.86	42.50	\$1268	\$1415	\$423	\$336

Standard with **Freestanding** file/file pedestal on **left** and faux pedestal **right**. Pedestal locks. Bow top overhangs 2 1/4" at ends and 8" on center.

- 84" wide desks are shipped RTA (ready to assemble) in 2 cartons.

Required Specifications

Top finish
Top/edge detail
Base finish
Lock finish

Optional Specifications

HP laminate Handles
Key # Modesty finish glazed
Modesty type
Grommet position or power block cut-out

Accessories

Power block
Keyboard
Pencil drawer

SINGLE PEDESTAL DESKS

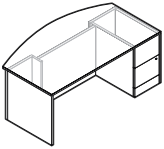

Single Pedestal Bow Top Desk - RIGHT

MODEL#	DIMENSIONS D x W x H	FREIGHT CLASS	WT./LBS.	CUBIC FT.	1" TOP	1.5" TOP	GLAZE ADD	HP ADD
Z4284FB2R	42 x 84 x 29-29.5	125	322.35	21.75	\$1541	\$1766	\$648	\$717
Z4272FB2R	42 x 72 x 29-29.5	150	315	59	\$1462	\$1659	\$536	\$538
Z3672FB2R	36 x 72 x 29-29.5	150	281.35	50.75	\$1356	\$1529	\$536	\$404
Z3666FB2R	36 x 66 x 29-29.5	150	274.68	46.75	\$1319	\$1480	\$479	\$404
Z3660FB2R	36 x 60 x 29-29.5	125	259.86	42.50	\$1268	\$1415	\$423	\$336

Standard with **Freestanding** faux pedestal **left** and file/file pedestal on **right**. Pedestal locks. Bow top overhangs 2 ¼" at ends and 8" on center.

- 84" wide desks are shipped RTA (ready to assemble) in 2 cartons.

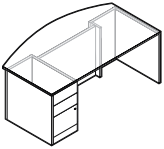

Single Pedestal Bow Top Desk - LEFT

Z4284FB3L	42 x 84 x 29-29.5	125	320.25	21.75	\$1567	\$1791	\$648	\$717
Z4272FB3L	42 x 72 x 29-29.5	150	313	59	\$1488	\$1684	\$536	\$538
Z3672FB3L	36 x 72 x 29-29.5	150	279.77	50.75	\$1381	\$1555	\$536	\$404
Z3666FB3L	36 x 66 x 29-29.5	150	273.10	46.75	\$1346	\$1506	\$479	\$404
Z3660FB3L	36 x 60 x 29-29.5	125	258.27	42.50	\$1309	\$1458	\$423	\$336

Standard with **Freestanding** box/box/file pedestal on **left** and faux pedestal **right**. File drawer and lower box drawer lock. Bow top overhangs 2 ¼" at ends and 8" on center.

- 84" wide desks are shipped RTA (ready to assemble) in 2 cartons.

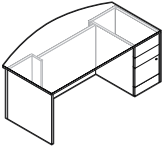

Single Pedestal Bow Top Desk - RIGHT

Z4284FB3R	42 x 84 x 29-29.5	125	320.25	21.75	\$1567	\$1791	\$648	\$717
Z4272FB3R	42 x 72 x 29-29.5	150	313	59	\$1488	\$1684	\$536	\$538
Z3672FB3R	36 x 72 x 29-29.5	150	279.77	50.75	\$1381	\$1555	\$536	\$404
Z3666FB3R	36 x 66 x 29-29.5	150	273.10	46.75	\$1346	\$1506	\$479	\$404
Z3660FB3R	36 x 60 x 29-29.5	125	258.27	42.50	\$1309	\$1458	\$423	\$336

Standard with **Freestanding** faux pedestal **left** and box/box/file pedestal on **right**. File drawer and lower box drawer lock. Bow top overhangs 2 ¼" at ends and 8" on center.

- 84" wide desks are shipped RTA (ready to assemble) in 2 cartons.

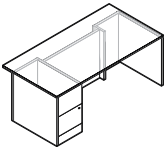

Single Pedestal Desk - LEFT

Z4284F2L	42 x 84 x 29-29.5	125	326.55	21.75	\$1469	\$1660	\$648	\$717
Z4272F2L	42 x 72 x 29-29.5	150	327	59	\$1398	\$1562	\$536	\$538
Z3684F2L	36 x 84 x 29-29.5	150	290.85	59	\$1379	\$1544	\$648	\$538
Z3672F2L	36 x 72 x 29-29.5	150	265.65	50.75	\$1294	\$1437	\$536	\$404
Z3666F2L	36 x 66 x 29-29.5	150	254.10	46.75	\$1262	\$1394	\$479	\$404
Z3660F2L	36 x 60 x 29-29.5	150	243.60	42.50	\$1230	\$1352	\$423	\$336
Z3072F2L	29.69 x 72 x 29-29.5	150	265.65	50.75	\$1294	\$1437	\$536	\$404
Z3066F2L	29.69 x 66 x 29-29.5	150	254.10	46.75	\$1262	\$1393	\$479	\$404
Z3060F2L	29.69 x 60 x 29-29.5	150	243.60	42.50	\$1230	\$1352	\$423	\$336

Standard with **Freestanding** file/file pedestal on **left** and faux pedestal **right**. Pedestal locks.

- 84" wide desks are shipped RTA (ready to assemble) in 2 cartons.

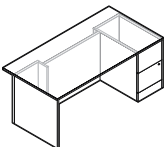

Single Pedestal Desk - RIGHT

Z4284F2R	42 x 84 x 29-29.5	125	326.55	21.75	\$1469	\$1660	\$648	\$717
Z4272F2R	42 x 72 x 29-29.5	150	327	59	\$1398	\$1562	\$536	\$538
Z3684F2R	36 x 84 x 29-29.5	150	290.85	59	\$1379	\$1544	\$648	\$538
Z3672F2R	36 x 72 x 29-29.5	150	265.65	50.75	\$1294	\$1437	\$536	\$404
Z3666F2R	36 x 66 x 29-29.5	150	254.10	46.75	\$1262	\$1394	\$479	\$404
Z3660F2R	36 x 60 x 29-29.5	150	243.60	42.50	\$1230	\$1352	\$423	\$336
Z3072F2R	29.69 x 72 x 29-29.5	150	265.65	50.75	\$1294	\$1437	\$536	\$404
Z3066F2R	29.69 x 66 x 29-29.5	150	254.10	46.75	\$1262	\$1393	\$479	\$404
Z3060F2R	29.69 x 60 x 29-29.5	150	243.60	42.50	\$1230	\$1352	\$423	\$336

Standard with **Freestanding** faux pedestal on **left** and file/file pedestal **right**. Pedestal locks.

- 84" wide desks are shipped RTA (ready to assemble) in 2 cartons.

Required Specifications

Top finish
Top/edge detail
Base finish
Lock finish

Optional Specifications

HP laminate Handles
Key # Modesty finish glazed
Modesty type
Grommet position or power block cut-out

Accessories

Power block
Keyboard
Pencil drawer

SINGLE PEDESTAL DESKS

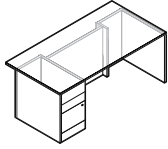

Single Pedestal Desk - LEFT*

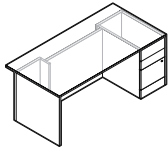

Single Pedestal Desk - RIGHT*

MODEL#	DIMENSIONS	FREIGHT CLASS	WT/LBS.	CUBIC FT.	1" TOP	1.5" TOP	GLAZE ADD	HP ADD
D x W x H								
Z4284F3L	42 x 84 x 29-29.5	125	324.45	21.75	\$1496	\$1685	\$648	\$717
Z4272F3L	42 x 72 x 29-29.5	150	324	59	\$1424	\$1588	\$536	\$538
Z3684F3L	36 x 84 x 29-29.5	150	288.75	59	\$1379	\$1544	\$648	\$538
Z3672F3L	36 x 72 x 29-29.5	150	263.55	50.75	\$1320	\$1463	\$536	\$404
Z3666F3L	36 x 66 x 29-29.5	150	252	46.75	\$1288	\$1420	\$479	\$404
Z3660F3L	36 x 60 x 29-29.5	150	241.50	42.50	\$1239	\$1359	\$423	\$336
Z3072F3L	29.69 x 72 x 29-29.5	150	253.55	50.75	\$1320	\$1463	\$536	\$404
Z3066F3L	29.69 x 66 x 29-29.5	150	252	46.75	\$1288	\$1419	\$479	\$404
Z3060F3L	29.69 x 60 x 29-29.5	150	241.50	42.50	\$1239	\$1359	\$423	\$336

Standard with **Freestanding** box/box/file pedestal on **left** and faux pedestal **right**. File drawer and lower box drawer lock.
 • 84" wide desks are shipped RTA (ready to assemble) in 2 cartons.

Z4284F3R	42 x 84 x 29-29.5	125	324.45	21.75	\$1496	\$1685	\$648	\$717
Z4272F3R	42 x 72 x 29-29.5	150	324	59	\$1424	\$1588	\$536	\$538
Z3684F3R	36 x 84 x 29-29.5	150	288.75	59	\$1379	\$1544	\$648	\$538
Z3672F3R	36 x 72 x 29-29.5	150	263.55	50.75	\$1320	\$1463	\$536	\$404
Z3666F3R	36 x 66 x 29-29.5	150	252	46.75	\$1288	\$1420	\$479	\$404
Z3660F3R	36 x 60 x 29-29.5	150	241.50	42.50	\$1239	\$1359	\$423	\$336
Z3072F3R	29.69 x 72 x 29-29.5	150	263.55	50.75	\$1320	\$1463	\$536	\$404
Z3066F3R	29.69 x 66 x 29-29.5	150	252	46.75	\$1288	\$1419	\$479	\$404
Z3060F3R	29.69 x 60 x 29-29.5	150	241.50	42.50	\$1239	\$1359	\$423	\$336

Standard with **Freestanding** faux pedestal on **left** and box/box/file pedestal **right**. File drawer and lower box drawer lock.
 • 84" wide desks are shipped RTA (ready to assemble) in 2 cartons.

RETURNS

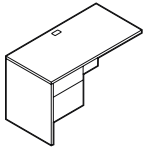

Flush Return - LEFT

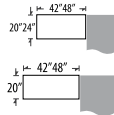

Z2448FL	24 x 48 x 29-29.5	125	155	24	\$717	\$786	N/A	\$197
Z2442FL	24 x 42 x 29-29.5	125	144	21.25	\$717	\$779	N/A	\$165
Z2048FL	20 x 48 x 29-29.5	125	140	20.25	\$666	\$728	N/A	\$165
Z2042FL	20 x 42 x 29-29.5	125	130	18	\$666	\$728	N/A	\$165

Standard with **box/file** drawer pedestal. One pencil tray. Pedestal locks. Grommet in worksurface. Pedestal is on the **left**. For use with right handed single pedestal desks, 20"/24" deep extended corners with narrow end panel or 20"/24" deep five-sided corners with narrow end panel.

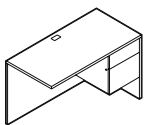

Flush Return - RIGHT

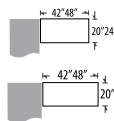

Z2448FR	24 x 48 x 29-29.5	125	155	24	\$717	\$786	N/A	\$197
Z2442FR	24 x 42 x 29-29.5	125	144	21.25	\$717	\$779	N/A	\$165
Z2048FR	20 x 48 x 29-29.5	125	140	20.25	\$666	\$728	N/A	\$165
Z2042FR	20 x 42 x 29-29.5	125	130	18	\$666	\$728	N/A	\$165

Standard with **box/file** drawer pedestal. One pencil tray. Pedestal locks. Grommet in worksurface. Pedestal is on the **right**. For use with right handed single pedestal desks, 20"/24" deep extended corners with narrow end panel or 20"/24" deep five-sided corners with narrow end panel.

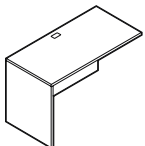

Flush Return - LEFT*

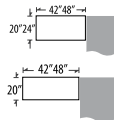

Z2448EL	24 x 48 x 29-29.5	65	107	4.30	\$507	\$576	N/A	\$197
Z2442EL	24 x 42 x 29-29.5	65	96	3.80	\$507	\$569	N/A	\$165
Z2048EL	20 x 48 x 29-29.5	65	97	4.30	\$467	\$530	N/A	\$165
Z2042EL	20 x 42 x 29-29.5	65	86	3.80	\$467	\$530	N/A	\$165

Return has **no pedestal**. Grommet in worksurface. For use with right handed single pedestal desks, 20"/24" deep extended corners with narrow end panel or 20"/24" deep five-sided corners with narrow end panel.

Required Specifications

Top finish
 Top/edge detail
 Base finish
 Lock finish

Optional Specifications

HP laminate
 Key #
 Modesty finish glazed (not returns)
 Grommet position or power block cut-out

Accessories

Power block
 Keyboard
 Pencil drawer

FLUSH RETURNS

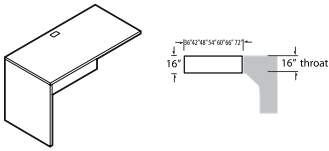

Flush Return - LEFT

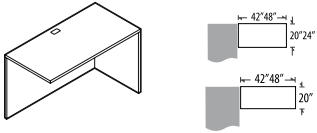

Flush Return - RIGHT**

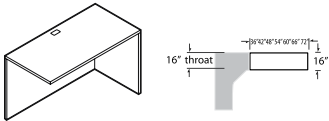

Flush Return - RIGHT

MODEL#	DIMENSIONS D x W x H	FREIGHT CLASS	WT/LBS.	CUBIC FT.	1" TOP	1.5" TOP	GLAZE ADD	HP ADD
Z1672RL	16 x 72 x 29-29.5	70	109.20	6	\$504	\$590	N/A	\$202
Z1666RL	16 x 66 x 29-29.5	70	101.85	5.75	\$483	\$563	N/A	\$202
Z1660RL	16 x 60 x 29-29.5	70	94.50	5.25	\$455	\$528	N/A	\$168
Z1654RL	16 x 54 x 29-29.5	70	87.15	5.25	\$431	\$498	N/A	\$168
Z1648RL	16 x 48 x 29-29.5	70	79.80	4.25	\$396	\$457	N/A	\$135
Z1642RL	16 x 42 x 29-29.5	70	70.35	4	\$355	\$410	N/A	\$135
Z1636RL	16 x 36 x 29-29.5	70	61.95	3.50	\$317	\$366	N/A	\$101

16" Throat. Return has **no pedestal**. Grommet in worksurface. Shipped RTA (ready to assemble). For use with extended corners, desks and islands with 16" throat.

Z2448ER	24 x 48 x 29-29.5	65	107	4.30	\$507	\$576	N/A	\$197
Z2442ER	24 x 42 x 29-29.5	65	96	3.80	\$507	\$569	N/A	\$165
Z2048ER	20 x 48 x 29-29.5	65	97	4.30	\$467	\$530	N/A	\$165
Z2042ER	20 x 42 x 29-29.5	65	86	3.80	\$467	\$530	N/A	\$165

Return has **no pedestal**. Grommet in worksurface. Shipped RTA (ready to assemble). For use with right handed single pedestal desks, 20"/24" deep extended corners with narrow end panel or 20"/24" deep five-sided corners with narrow end panel.

Z1672RR	16 x 72 x 29-29.5	70	109.20	6	\$504	\$590	N/A	\$202
Z1666RR	16 x 66 x 29-29.5	70	101.85	5.75	\$483	\$563	N/A	\$202
Z1660RR	16 x 60 x 29-29.5	70	94.50	5.25	\$455	\$528	N/A	\$168
Z1654RR	16 x 54 x 29-29.5	70	87.15	5.25	\$431	\$498	N/A	\$168
Z1648RR	16 x 48 x 29-29.5	70	79.80	4.25	\$396	\$457	N/A	\$135
Z1642RR	16 x 42 x 29-29.5	70	70.35	4	\$355	\$410	N/A	\$135
Z1636RR	16 x 36 x 29-29.5	70	61.95	3.50	\$317	\$366	N/A	\$101

16" Throat. Return has **no pedestal**. Grommet in worksurface. Shipped RTA (ready to assemble). For use with extended corners, desks and islands with 16" throat.

SPACE SAVER RETURNS

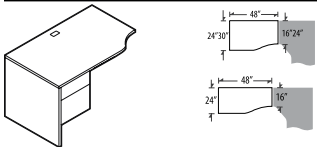

Space Saver Return - LEFT*

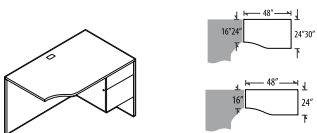

Space Saver Return - RIGHT*

Z3048FSL	29.69 x 48 x 29-29.5	150	166	29	\$788	\$883	N/A	\$285
Z2448FSL	24 x 48 x 29-29.5	125	154	24.25	\$798	\$882	N/A	\$180

Standard with **box/file** drawer pedestal. Grommet in worksurface. One pencil tray. Pedestal locks. Connects to 24" or 16" component.

Z3048FSR	29.69 x 48 x 29-29.5	150	166	29	\$788	\$883	N/A	\$285
Z2448FSR	24 x 48 x 29-29.5	125	154	24.25	\$798	\$882	N/A	\$180

Standard with **box/file** drawer pedestal. Grommet in worksurface. One pencil tray. Pedestal locks. Connects to 24" or 16" component.

Required Specifications

- Top finish
- Top/edge detail
- Base finish
- Lock finish*

Optional Specifications

- HP laminate
- Handles*
- Key #*
- Modesty type
- Grommet position or power block cut-out

Accessories

- Power block
- Keyboard**
- Pencil drawer

RETURNS

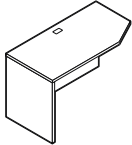

Space Saver Return - LEFT*

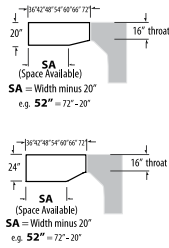

MODEL#	DIMENSIONS	FREIGHT CLASS	WT/LBS.	CUBIC FT.	1" TOP	1.5" TOP	GLAZE ADD	HP ADD
Z247216RL	24 x 72 x 29-29.5	65	135.45	6	\$600	\$729	N/A	\$269
Z246616RL	24 x 66 x 29-29.5	70	127.05	5.75	\$573	\$691	N/A	\$269
Z246016RL	24 x 60 x 29-29.5	70	117.60	5.25	\$537	\$646	N/A	\$224
Z245416RL	24 x 54 x 29-29.5	70	108.15	5.25	\$507	\$607	N/A	\$224
Z244816RL	24 x 48 x 29-29.5	65	99.75	4.25	\$465	\$555	N/A	\$180
Z244216RL	24 x 42 x 29-29.5	70	88.20	4	\$417	\$497	N/A	\$180
Z243616RL	24 x 36 x 29-29.5	70	77.70	3.50	\$377	\$448	N/A	\$135
Z207216RL	20 x 72 x 29-29.5	70	122.85	6	\$549	\$656	N/A	\$269
Z206616RL	20 x 66 x 29-29.5	70	114.45	5.75	\$523	\$621	N/A	\$269
Z206016RL	20 x 60 x 29-29.5	70	106.05	5.25	\$491	\$582	N/A	\$224
Z205416RL	20 x 54 x 29-29.5	70	97.65	5.25	\$462	\$544	N/A	\$224
Z204816RL	20 x 48 x 29-29.5	70	90.30	4.25	\$425	\$499	N/A	\$180
Z204216RL	20 x 42 x 29-29.5	70	79.80	4	\$381	\$448	N/A	\$180
Z203616RL	20 x 36 x 29-29.5	70	70.35	3.50	\$343	\$401	N/A	\$135

16" Throat. Return has **no pedestal**. Grommet in worksurface. Shipped RTA (ready to assemble). For use with extended corners, desks and islands with 16"throat. Accepts same depth storage shells under worksurface, see pages 186-188.

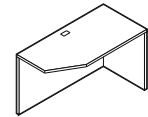

Space Saver Return - RIGHT*

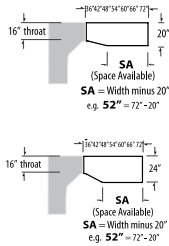

Z247216RR	24 x 72 x 29-29.5	65	135.45	6	\$600	\$729	N/A	\$269
Z246616RR	24 x 66 x 29-29.5	70	127.05	5.75	\$573	\$691	N/A	\$269
Z246016RR	24 x 60 x 29-29.5	70	117.60	5.25	\$537	\$646	N/A	\$224
Z245416RR	24 x 54 x 29-29.5	70	108.15	5.25	\$507	\$607	N/A	\$224
Z244816RR	24 x 48 x 29-29.5	65	99.75	4.25	\$465	\$555	N/A	\$180
Z244216RR	24 x 42 x 29-29.5	70	88.20	4	\$417	\$497	N/A	\$180
Z243616RR	24 x 36 x 29-29.5	70	77.70	3.50	\$377	\$448	N/A	\$135
Z207216RR	20 x 72 x 29-29.5	70	122.85	6	\$549	\$656	N/A	\$269
Z206616RR	20 x 66 x 29-29.5	70	114.45	5.75	\$523	\$621	N/A	\$269
Z206016RR	20 x 60 x 29-29.5	70	106.05	5.25	\$491	\$582	N/A	\$224
Z205416RR	20 x 54 x 29-29.5	70	97.65	5.25	\$462	\$544	N/A	\$224
Z204816RR	20 x 48 x 29-29.5	70	90.30	4.25	\$425	\$499	N/A	\$180
Z204216RR	20 x 42 x 29-29.5	70	79.80	4	\$381	\$448	N/A	\$180
Z203616RR	20 x 36 x 29-29.5	70	70.35	3.50	\$343	\$401	N/A	\$135

16" Throat. Return has **no pedestal**. Grommet in worksurface. Shipped RTA (ready to assemble). For use with extended corners, desks and islands with 16"throat. Accepts same depth storage shells under worksurface, see pages 186-188.

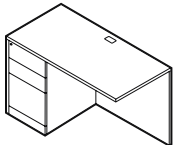

Full to Floor Flush Return - LEFT**

Z24723L	24 x 72 x 29-29.5	125	171	24.50	\$1195	\$1301	N/A	\$269
Z24663L	24 x 66 x 29-29.5	125	171	24.50	\$1172	\$1269	N/A	\$269
Z24603L	24 x 60 x 29-29.5	125	171	24.50	\$1097	\$1190	N/A	\$248
Z24543L	24 x 54 x 29-29.5	125	171	24.50	\$1060	\$1144	N/A	\$248
Z24483L	24 x 48 x 29-29.5	125	171	24.50	\$1000	\$1074	N/A	\$197
Z20723L	20 x 72 x 29-29.5	65	97	4.30	\$1093	\$1185	N/A	\$269
Z20663L	20 x 66 x 29-29.5	65	97	4.30	\$1056	\$1144	N/A	\$269
Z20603L	20 x 60 x 29-29.5	65	97	4.30	\$1037	\$1116	N/A	\$224
Z20543L	20 x 54 x 29-29.5	65	97	4.30	\$995	\$1069	N/A	\$224
Z20483L	20 x 48 x 29-29.5	125	154	20.75	\$972	\$1037	N/A	\$165

Standard with box/box/file pedestal on **left**. Grommet in worksurface. One pencil tray. File drawer and lower box drawer lock.

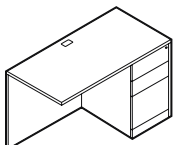

Full to Floor Flush Return - RIGHT**

Z24723R	24 x 72 x 29-29.5	125	171	24.50	\$1195	\$1301	N/A	\$269
Z24663R	24 x 66 x 29-29.5	125	171	24.50	\$1172	\$1269	N/A	\$269
Z24603R	24 x 60 x 29-29.5	125	171	24.50	\$1097	\$1190	N/A	\$248
Z24543R	24 x 54 x 29-29.5	125	171	24.50	\$1060	\$1144	N/A	\$248
Z24483R	24 x 48 x 29-29.5	125	171	24.50	\$1000	\$1074	N/A	\$197
Z20723R	20 x 72 x 29-29.5	65	97	4.30	\$1093	\$1185	N/A	\$269
Z20663R	20 x 66 x 29-29.5	65	97	4.30	\$1056	\$1144	N/A	\$269
Z20603R	20 x 60 x 29-29.5	65	97	4.30	\$1037	\$1116	N/A	\$224
Z20543R	20 x 54 x 29-29.5	65	97	4.30	\$995	\$1069	N/A	\$224
Z20483R	20 x 48 x 29-29.5	125	154	20.75	\$972	\$1037	N/A	\$165

Standard with box/box/file pedestal on **right**. Grommet in worksurface. One pencil tray. File drawer and lower box drawer lock.

Required Specifications

- Top finish
- Top/edge detail
- Base finish
- Lock finish**

Optional Specifications

- HP laminate
- Handles**
- Key #**
- Modesty type
- Grommet position or power block cut-out

Accessories

- Power block
- Pencil drawer*

BRIDGES

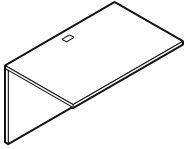

Flush Bridge*

MODEL#	DIMENSIONS D x W x H	FREIGHT CLASS	WT/LBS.	CUBIC FT.	1" TOP	1.5" TOP	GLAZE ADD	HP ADD
Z2448FB	24 x 48 x 29-29.5	70	91	4.30	\$443	\$512	N/A	\$180
Z2442FB	24 x 42 x 29-29.5	70	79	3.80	\$410	\$472	N/A	\$180
Z2436FB	24 x 36 x 29-29.5	70	69	3.30	\$410	\$472	N/A	\$135
Z2048FB	20 x 48 x 29-29.5	70	83	4.30	\$429	\$491	N/A	\$180
Z2042FB	20 x 42 x 29-29.5	70	72	3.80	\$398	\$460	N/A	\$180
Z2036FB	20 x 36 x 29-29.5	70	63	3.30	\$398	\$460	N/A	\$135

Top surface, back panel and hardware to create a "U" shape by connecting two units with full end panels. Grommet in worksurface. Shipped RTA (ready to assemble).

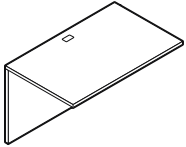

Flush Bridge

Z1648B	15.8 x 48 x 29-29.5	70	66.15	4.25	\$335	\$396	N/A	\$135
Z1642B	15.8 x 42 x 29-29.5	70	59.85	3.75	\$293	\$348	N/A	\$135

16" Throat. Top surface, back panel and hardware to create a "U" shape by connecting two units with a 16" throat and full end panels. Grommet in worksurface. Shipped RTA (ready to assemble).

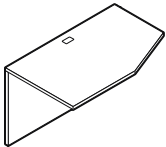

Space Saver Bridge - LEFT

Z244816BL	24 x 48 x 29-29.5	70	82	4.25	\$392	\$482	N/A	\$180
Z244216BL	24 x 42 x 29-29.5	70	71	3.75	\$344	\$424	N/A	\$180
Z214816BL	21 x 48 x 29-29.5	70	76	4.25	\$364	\$438	N/A	\$180
Z214216BL	21 x 42 x 29-29.5	70	65	3.75	\$314	\$381	N/A	\$180

16" Throat. Top surface, back panel and hardware to connect extended corners, desks and islands with a 16" throat. Grommet in worksurface. Shipped RTA (ready to assemble).

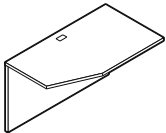

Space Saver Bridge - RIGHT

Z244816BR	24 x 48 x 29-29.5	70	82	4.25	\$392	\$482	N/A	\$180
Z244216BR	24 x 42 x 29-29.5	70	71	3.75	\$344	\$424	N/A	\$180
Z214816BR	21 x 48 x 29-29.5	70	76	4.25	\$364	\$438	N/A	\$180
Z214216BR	21 x 42 x 29-29.5	70	65	3.75	\$314	\$381	N/A	\$180

16" Throat. Top surface, back panel and hardware to connect extended corners, desks and islands with a 16" throat. Grommet in worksurface. Shipped RTA (ready to assemble).

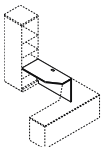

Transitional Bridge - LEFT

Z2148TRBL	21 x 48 x 29-29.5	70	75.83	4.25	\$378	\$452	N/A	\$180
Z2142TRBL	21 x 42 x 29-29.5	70	64.78	3.75	\$330	\$397	N/A	\$180

For 21" Wide Storage Module. Top surface, back panel and hardware to connect 21" wide storage module with 16" throat. Grommet in worksurface. Shipped RTA (ready to assemble).

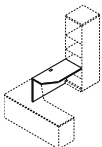

Transitional Bridge - RIGHT

Z2148TRBR	21 x 48 x 29-29.5	70	75.83	4.25	\$378	\$452	N/A	\$180
Z2142TRBR	21 x 42 x 29-29.5	70	64.78	3.75	\$330	\$397	N/A	\$180

For 21" Wide Storage Module. Top surface, back panel and hardware to connect 21" wide storage module with 16" throat. Grommet in worksurface. Shipped RTA (ready to assemble).

Required Specifications

- Top finish
- Top/edge detail
- Base finish
- Lock finish*

Optional Specifications

- HP laminate
- Grommet position or power block cut-out

Accessories

- Power block
- Pencil drawer*

BRIDGES

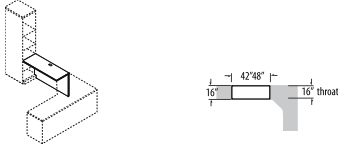

Transitional Bridge - LEFT

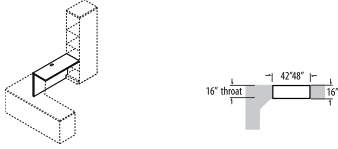

Transitional Bridge - RIGHT

MODEL#	DIMENSIONS D x W x H	FREIGHT CLASS	WT./LBS.	CUBIC FT.	1" TOP	1.5" TOP	GLAZE ADD	HP ADD
Z1648TRBL	16 x 48 x 29-29.5	70	68.58	4.25	\$350	\$411	N/A	\$135
Z1642TRBL	16 x 42 x 29-29.5	70	58.96	3.75	\$308	\$364	N/A	\$135

For 16" Wide Storage Module. Top surface, back panel and hardware to connect 16" wide storage module with 16" throat. Grommet in worksurface. Shipped RTA (ready to assemble).

Z1648TRBR	16 x 48 x 29-29.5	70	68.58	4.25	\$350	\$411	N/A	\$135
Z1642TRBR	16 x 42 x 29-29.5	70	58.96	3.75	\$308	\$364	N/A	\$135

For 16" Wide Storage Module. Top surface, back panel and hardware to connect 16" wide storage module with 16" throat. Grommet in worksurface. Shipped RTA (ready to assemble).

CREDENZAS

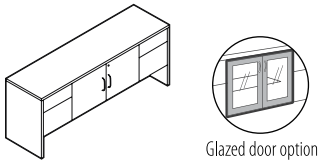

Center Storage Credenza**

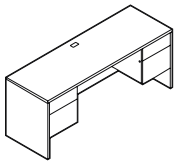

Kneespace Credenza*

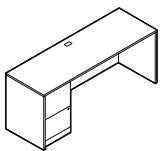

Full to Floor Single Pedestal Credenza- LEFT*

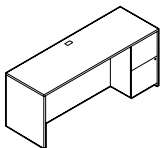

Full to Floor Single Pedestal Credenza- RIGHT*

Z2072C	20 x 72 x 29-29.5	100	286	30	\$1458	\$1814	\$478	\$269
--------	-------------------	-----	-----	----	---------------	---------------	--------------	--------------

Standard with box/file pedestals on both sides and self-closing hinged center doors covering one adjustable shelf. Pedestals and doors lock, keyed alike. One pencil tray.

Z2472CK	24 x 72 x 29-29.5	125	262	35.50	\$1183	\$1382	N/A	\$269
Z2466CK	24 x 66 x 29-29.5	125	250	33	\$1183	\$1338	N/A	\$269
Z2072CK	20 x 72 x 29-29.5	125	235	30	\$1131	\$1244	N/A	\$269
Z2066CK	20 x 66 x 29-29.5	100	225	27.75	\$1131	\$1219	N/A	\$269
Z2060CK	20 x 60 x 29-29.5	100	219	25.25	\$1087	\$1156	N/A	\$224

Standard with box/file pedestals on both sides. Center is open. Pedestals lock, keyed alike. One pencil tray. Grommet in worksurface.

Z2472CS2L	24 x 72 x 29-29.5	100	228	25.75	\$1112	\$1223	N/A	\$269
Z2466CS2L	24 x 66 x 29-29.5	125	217	32.75	\$1092	\$1194	N/A	\$269
Z2072CS2L	20 x 72 x 29-29.5	125	203	30.25	\$1019	\$1112	N/A	\$269
Z2066CS2L	20 x 66 x 29-29.5	125	193	27.75	\$981	\$1064	N/A	\$269

Standard with full to floor file/file pedestal on the **left**. Pedestal locks. One pencil tray. Grommet in worksurface.

Z2472CS2R	24 x 72 x 29-29.5	100	228	25.75	\$1112	\$1223	N/A	\$269
Z2466CS2R	24 x 66 x 29-29.5	125	217	32.75	\$1092	\$1194	N/A	\$269
Z2072CS2R	20 x 72 x 29-29.5	125	203	30.25	\$1019	\$1112	N/A	\$269
Z2066CS2R	20 x 66 x 29-29.5	125	193	27.75	\$981	\$1064	N/A	\$269

Standard with full to floor file/file pedestal on the **right**. Pedestal locks. One pencil tray. Grommet in worksurface.

Required Specifications

Top finish
Top/edge detail
Base finish
Lock finish*

Optional Specifications

HP laminate
Key #*
Modesty type (only Z2xxxxCK)
Grommet position or power block cut-out

Handles*
Glazed door**

Accessories

Keyboard**
Power block (not Z2072C)
Pencil drawer (Z2472S2L/R only)

CRENZAS

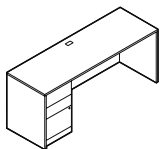

Full to Floor Single Pedestal Credenza- LEFT*

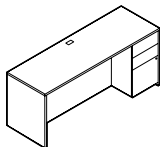

Full to Floor Single Pedestal Credenza- RIGHT*

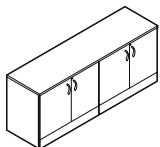

Glazed door option

Storage Cabinet Credenza**

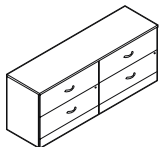

Storage Cabinet Credenza

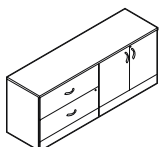

Glazed door option

Lateral File/Storage Cabinet Credenza**

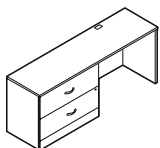

Kneespace Lateral File Credenza - LEFT

MODEL#	DIMENSIONS D x W x H	FREIGHT CLASS	WT/LBS.	CUBIC FT.	1" TOP	1.5" TOP	GLAZE ADD	HP ADD
Z2472CS4L	24 x 72 x 29-29.5	125	228	35.75	\$1158	\$1269	N/A	\$269
Z2466CS4L	24 x 66 x 29-29.5	125	217	32.75	\$1138	\$1240	N/A	\$269
Z2072CS4L	20 x 72 x 29-29.5	125	203	30.25	\$1056	\$1146	N/A	\$269
Z2066CS4L	20 x 66 x 29-29.5	125	193	25.75	\$1019	\$1107	N/A	\$269

Standard with full to floor box/box/file pedestal on the **left**. File drawer and lower box drawer lock. One pencil tray. Grommet in worksurface.

Z2472CS4R	24 x 72 x 29-29.5	125	228	35.75	\$1158	\$1269	N/A	\$269
Z2466CS4R	24 x 66 x 29-29.5	125	217	32.75	\$1138	\$1240	N/A	\$269
Z2072CS4R	20 x 72 x 29-29.5	125	203	30.25	\$1056	\$1148	N/A	\$269
Z2066CS4R	20 x 66 x 29-29.5	125	193	25.75	\$1019	\$1107	N/A	\$269

Standard with full to floor box/box/file pedestal on the **right**. File drawer and lower box drawer lock. One pencil tray. Grommet in worksurface.

Z2472SCSC	24 x 72 x 29.5-30	100	345	35.75	\$1597	\$1704	\$1072	\$269
Z2072SCSC	20 x 72 x 29.5-30	92.5	315	30.25	\$1403	\$1519	\$1072	\$269

Two storage cabinets side-by-side. Hinged doors cover one adjustable shelf. Locking doors keyed alike.

Z2472LF2	24 x 72 x 29-29.5	100	345	35.75	\$1842	\$2099	N/A	\$269
Z2072LF2	20 x 72 x 29-29.5	92.5	315	30.25	\$1804	\$2097	N/A	\$269

Two 2-drawer lateral files side-by-side. Locking drawers, keyed alike. File bars included for side-to-side and front-to-back letter and legal filing capability. Anti-lock tilt suspension

Z2472LS	24 x 72 x 29-29.5	100	321	35.75	\$1648	\$1896	\$536	\$269
Z2072LS	20 x 72 x 29-29.5	100	286	30.25	\$1610	\$1895	\$536	\$269

One 2-drawer lateral file and one storage cabinet. Locking door/drawers, keyed alike. Storage cabinet includes one adjustable shelf. File bars included for side-to-side and front-to-back letter and legal filing capability. Anti-lock tilt suspension.

- File drawer construction is for accommodating hanging files NOT for stacking materials on the drawer bottom.

Z2472LKL	24 x 72 x 29-29.5	125	262	35.75	\$1448	\$1669	N/A	\$269
Z2072LKL	20 x 72 x 29-29.5	125	235	30.25	\$1411	\$1669	N/A	\$269

One 2-drawer lateral file on the **left**. Locking drawers. File bars included for side-to-side and front-to-back letter/legal filing capability. Anti-lock tilt suspension. Grommet in worksurface.

- File drawer construction is for accommodating hanging files NOT for stacking materials on the drawer bottom.

Required Specifications

Top finish Base finish
Top/edge detail
Handles**
Lock finish*

Optional Specifications

HP laminate Handles
Key # Glazed door**
Grommet position or power block cut-out

Accessories

Keyboard*
Pencil drawer*
Power block*

CREDENZAS

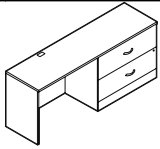

Kneespace Lateral File Credenza - RIGHT

MODEL#	DIMENSIONS D x W x H	FREIGHT CLASS	WT/LBS.	CUBIC FT.	1" TOP	1.5" TOP	GLAZE ADD	HP ADD
Z2472LKR	24 x 72 x 29-29.5	125	262	35.75	\$1448	\$1669	N/A	\$269
Z2072LKR	20 x 72 x 29-29.5	125	235	30.25	\$1411	\$1669	N/A	\$269

One 2-drawer lateral file on the **right**. Locking drawers. File bars included for side-to-side and front-to-back letter/legal filing capability. Anti-lock tilt suspension. Grommet in worksurface.

- File drawer construction is for accommodating hanging files *NOT* for stacking materials on the drawer bottom.

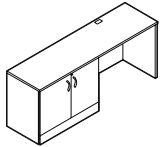

Glazed door option

Kneespace Storage Cabinet Credenza- LEFT**

Z2472SKL	24 x 72 x 29-29.5	125	241	35.75	\$1141	\$1370	\$536	\$269
Z2072SKL	20 x 72 x 29-29.5	125	207	30.25	\$1103	\$1369	\$536	\$269

One storage cabinet on the **left**. Locking doors. Storage cabinet has one adjustable shelf. Grommet in worksurface.

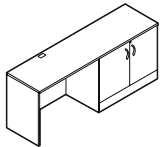

Glazed door option

Kneespace Storage Cabinet Credenza- RIGHT**

Z2472SKR	24 x 72 x 29-29.5	125	241	35.75	\$1141	\$1370	\$536	\$269
Z2072SKR	20 x 72 x 29-29.5	125	207	30.25	\$1103	\$1369	\$536	\$269

One storage cabinet on the **right**. Locking doors. Storage cabinet has one adjustable shelf. Grommet in worksurface.

5-SIDED CORNERS

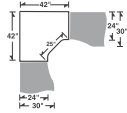
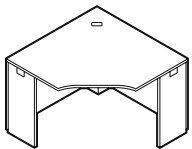

5-Sided Corner, 24" Throat

Z42245C	42 x 42 x 29-29.5	65	133	5.75	\$691	\$837	N/A	\$362
---------	-------------------	----	-----	------	--------------	--------------	-----	--------------

Connects to **30" D** space saver connectable surfaces, **24" D** connectables, returns and bridge. Grommet in worksurface. Narrow end panels on left and right. Shipped RTA (ready to assemble). *Not Freestanding.*

- Modesty Panel is **1" off of ground.**
- Full End Panel(s) are available - add **15% upcharge**

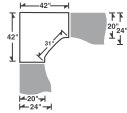
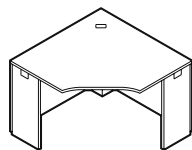

5-Sided Corner, 20" Throat

Z42205C	42 x 42 x 29-29.5	70	129	5.75	\$691	\$837	N/A	\$362
---------	-------------------	----	-----	------	--------------	--------------	-----	--------------

Connects to **24" D** space saver connectable surfaces, **20" D** returns, lateral files, storage/lateral file credenzas, credenzas, and bridges. Grommet in worksurface. Narrow end panels on left and right. Shipped RTA (ready to assemble). *Not freestanding.*

- Modesty Panel is **1" off of ground.**
- Full End Panel(s) are available - add **15% upcharge**

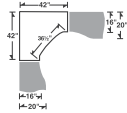
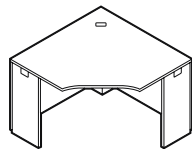

5-Sided Corner, 16" Throat

Z42165C	42 x 42 x 29-29.5	70	124	5.75	\$712	\$817	N/A	\$359
---------	-------------------	----	-----	------	--------------	--------------	-----	--------------

Connects to **20" D** space saver connectable surfaces, **16" D** returns, lateral files, storage/lateral file credenzas, credenzas, and bridges. Grommet in worksurface. Narrow end panels on left and right. Shipped RTA (ready to assemble). *Not freestanding.*

- Modesty Panel is **1" off of ground.**
- Full End Panel(s) are available - add **15% upcharge**

Required Specifications

Top finish Base finish
Top/edge detail
Handles**
Lock finish*

Optional Specifications

HP laminate Handles
Key # Glazed door**
Grommet position or power block cut-out

Accessories

Keyboard (Z42245C & Z42205C)
Power block

5-SIDED CORNERS

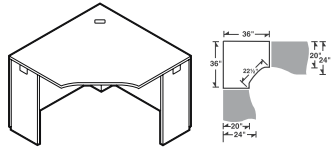

5-Sided Corner, 20" Throat

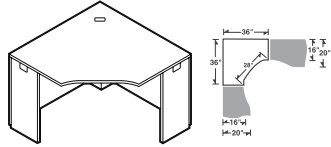

5-Sided Corner, 16" Throat

MODEL# DIMENSIONS FREIGHT CLASS WT/LBS. CUBIC FT. 1" TOP 1.5" TOP GLAZE ADD HP ADD

	D x W x H								
Z36205C	36 x 36 x 29-29.5	65	109	4.80	\$583	\$666	N/A	\$233	

Connects to **24" D** space saver connectable surfaces, **20" D** returns, lateral files, storage/lateral file credenzas, credenzas, and bridges. Grommet in worksurface. Narrow end panels on left and right. Shipped RTA (ready to assemble). *Not freestanding.*

- **Modesty Panel is 1" off of ground.**
- Full End Panel(s) are available - add **15% upcharge**

Z36165C	36 x 36 x 29-29.5	70	105	4.80	\$622	\$703	N/A	\$202	
---------	-------------------	----	-----	------	-------	-------	-----	-------	--

Connects to **20" D** space saver connectable surfaces, **16" D** returns, lateral files, storage/lateral file credenzas, credenzas, and bridges. Grommet in worksurface. Narrow end panels on left and right. Shipped RTA (ready to assemble). *Not freestanding.*

- **Modesty Panel is 1" off of ground.**
- Full End Panel(s) are available - add **15% upcharge**

LEFT EXTENDED CORNER DESKS

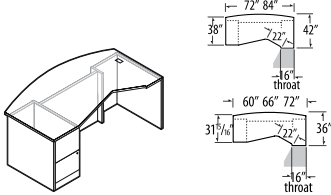

Single Pedestal Bow Top Extended Corner Desk - LEFT*

Z4284EB2L	42 x 84 x 29-29.5	125	316.05	20.50	\$1477	\$1680	\$648	\$717	
Z4272EB2L	42 x 72 x 29-29.5	150	331	59	\$1458	\$1632	\$536	\$538	
Z3672EB2L	36 x 72 x 29-29.5	150	273	50.75	\$1327	\$1480	\$536	\$404	
Z3666EB2L	36 x 66 x 29-29.5	150	260.40	46.75	\$1305	\$1445	\$479	\$404	
Z3660EB2L	36 x 60 x 29-29.5	125	257.25	42.50	\$1268	\$1396	\$423	\$336	

Extended worksurface on right. Standard with **Freestanding** full to floor file/file pedestal on **left** and faux pedestal on **right**. Pedestal locks. Connects to returns or bridges with a 16" throat. Corner has one grommet. Bow top overhangs 2 1/4" at ends and 6" on center.

- 84" wide desks are shipped RTA (ready to assemble) in 2 cartons.

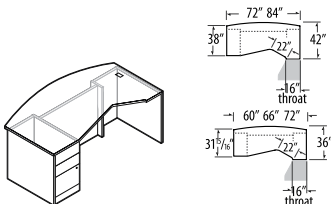

Single Pedestal Bow Top Extended Corner Desk - LEFT*

Z4284EB3L	42 x 84 x 29-29.5	125	315	20.50	\$1491	\$1693	\$648	\$717	
Z4272EB3L	42 x 72 x 29-29.5	150	329	59	\$1474	\$1648	\$536	\$538	
Z3672EB3L	36 x 72 x 29-29.5	150	270.90	50.75	\$1353	\$1506	\$536	\$404	
Z3666EB3L	36 x 66 x 29-29.5	150	259.35	46.75	\$1314	\$1454	\$479	\$404	
Z3660EB3L	36 x 60 x 29-29.5	125	255.15	42.50	\$1293	\$1421	\$423	\$336	

Extended worksurface on right. Standard with **Freestanding** full to floor box/box/file pedestal on **left** and faux pedestal on **right**. File drawer and lower box drawer lock. Connects to returns or bridges with a 16" throat. Corner has one grommet. Bow top overhangs 2 1/4" at ends and 6" on center.

- 84" wide desks are shipped RTA (ready to assemble) in 2 cartons.

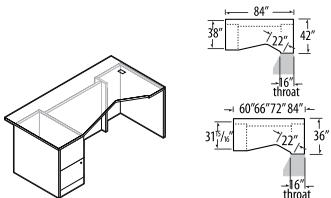

Single Pedestal Extended Corner Desk - LEFT*

Z4284E2L	42 x 84 x 29-29.5	125	321.30	20.50	\$1538	\$1732	\$648	\$717	
Z3684E2L	36 x 84 x 29-29.5	150	311.85	59	\$1473	\$1667	\$648	\$538	
Z3672E2L	36 x 72 x 29-29.5	150	278.25	50.75	\$1322	\$1466	\$536	\$404	
Z3666E2L	36 x 66 x 29-29.5	150	265.65	46.75	\$1286	\$1419	\$479	\$404	
Z3660E2L	36 x 60 x 29-29.5	125	259.35	42.50	\$1265	\$1385	\$423	\$336	

Extended worksurface on right. Standard with **Freestanding** full to floor file/file pedestal on **left** and faux pedestal on **right**. Pedestal locks. Connects to returns or bridges with a 16" throat. Corner has one grommet. Top overhangs 2 1/4"

- 84" wide desks are shipped RTA (ready to assemble) in 2 cartons.

Required Specifications

Top finish
Top/edge detail
Lock finish*
Base finish

Optional Specifications

HP laminate Handles*
Key #
Modesty panel type*
Grommet position or power block cut-out

Accessories

Keyboard (*Not available on Z36165C*)
Pencil drawer*
Power block

LEFT EXTENDED CORNER DESKS

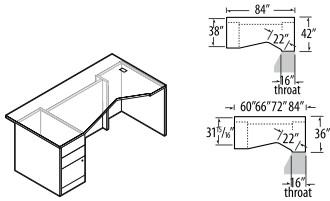

Single Pedestal Extended Corner Desk - LEFT

MODEL#	DIMENSIONS	FREIGHT CLASS	WT/LBS.	CUBIC FT.	1"TOP	1.5" TOP	GLAZE ADD	HP ADD	
D x W x H									
Z4284E3L	42 x 84 x 29-29.5	125	318.15	20.50	\$1487	\$1681	\$648	\$717	
Z3684E3L	36 x 84 x 29-29.5	150	309.75	59	\$1499	\$1692	\$648	\$538	
Z3672E3L	36 x 72 x 29-29.5	150	275.10	50.75	\$1349	\$1493	\$536	\$404	
Z3666E3L	36 x 66 x 29-29.5	150	263.55	46.75	\$1312	\$1445	\$479	\$404	
Z3660E3L	36 x 60 x 29-29.5	125	257.25	42.50	\$1290	\$1409	\$423	\$336	

Extended worksurface on right. Standard with **Freestanding** full to floor box/box/file pedestal on **left** and faux pedestal on **right**. File drawer and lower box drawer lock. Connects to returns or bridges with a 16" throat. Corner has one grommet. Top overhangs 2 1/4".

- 84" wide desks are shipped RTA (ready to assemble) in 2 cartons.

RIGHT EXTENDED CORNER DESKS

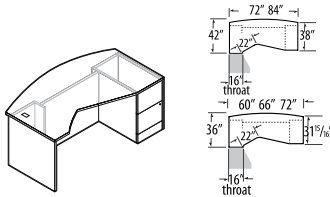

Single Pedestal Bow Top Extended Corner Desk - RIGHT

Z4284EB2R	42 x 84 x 29-29.5	125	316.05	41	\$1477	\$1680	\$648	\$717
Z4272EB2R	42 x 72 x 29-29.5	150	331	59	\$1458	\$1632	\$536	\$538
Z3672EB2R	36 x 72 x 29-29.5	150	273	50.75	\$1327	\$1480	\$536	\$404
Z3666EB2R	36 x 66 x 29-29.5	150	260.40	46.75	\$1305	\$1445	\$479	\$404
Z3660EB2R	36 x 60 x 29-29.5	125	257.25	42.50	\$1268	\$1396	\$423	\$336

Extended worksurface on right. Standard with faux pedestal on **left** and **Freestanding** full to floor file/file pedestal on **right**. Pedestal locks. Connects to returns or bridges with a 16" throat. Corner has one grommet. Bow top overhangs 2 1/4" at ends and 6" on center.

- 84" wide desks are shipped RTA (ready to assemble) in 2 cartons.

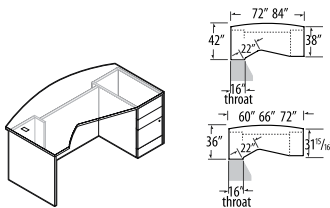

Single Pedestal Bow Top Extended Corner Desk - RIGHT

Z4284EB3R	42 x 84 x 29-29.5	125	315	41	\$1491	\$1693	\$648	\$717
Z4272EB3R	42 x 72 x 29-29.5	150	329	59	\$1474	\$1648	\$536	\$538
Z3672EB3R	36 x 72 x 29-29.5	150	270.90	50.75	\$1353	\$1506	\$536	\$404
Z3666EB3R	36 x 66 x 29-29.5	150	259.35	46.75	\$1314	\$1454	\$479	\$404
Z3660EB3R	36 x 60 x 29-29.5	125	255.15	42.50	\$1293	\$1421	\$423	\$336

Extended worksurface on right. Standard with faux pedestal on **left** and **Freestanding** full to floor box/box/file pedestal on **right**. File drawer and lower box drawer lock. Connects to returns or bridges with a 16" throat. Corner has one grommet. Bow top overhangs 2 1/4" at ends and 6" on center.

- 84" wide desks are shipped RTA (ready to assemble) in 2 cartons.

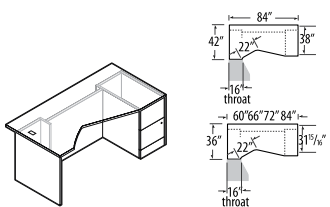

Single Pedestal Extended Corner Desk - RIGHT

Z4284E2R	42 x 84 x 29-29.5	125	321.30	41	\$1538	\$1666	\$648	\$717
Z3684E2R	36 x 84 x 29-29.5	150	311.85	59	\$1473	\$1667	\$648	\$538
Z3672E2R	36 x 72 x 29-29.5	150	278.25	50.75	\$1322	\$1466	\$536	\$404
Z3666E2R	36 x 66 x 29-29.5	150	265.65	46.75	\$1286	\$1419	\$479	\$404
Z3660E2R	36 x 60 x 29-29.5	125	259.35	42.50	\$1265	\$1385	\$423	\$336

Extended worksurface on right. Standard with **Freestanding** full to floor file/file pedestal on **right** and faux pedestal on **left**. Pedestal locks. Connects to returns or bridges with a 16" throat. Corner has one grommet. Top overhangs 2 1/4".

- 84" wide desks are shipped RTA (ready to assemble) in 2 cartons.

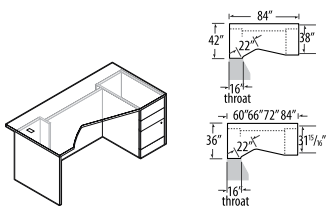

Single Pedestal Extended Corner Desk - RIGHT

Z4284E3R	42 x 84 x 29-29.5	125	318.15	41	\$1487	\$1681	\$648	\$717
Z3684E3R	36 x 84 x 29-29.5	150	309.75	59	\$1499	\$1692	\$648	\$538
Z3672E3R	36 x 72 x 29-29.5	150	275.10	50.75	\$1349	\$1493	\$536	\$404
Z3666E3R	36 x 66 x 29-29.5	150	263.55	46.75	\$1312	\$1445	\$479	\$404
Z3660E3R	36 x 60 x 29-29.5	125	257.25	42.50	\$1290	\$1409	\$423	\$336

Extended worksurface on right. Standard with **Freestanding** full to floor box/box/file pedestal on **right** and faux pedestal on **left**. File drawer and lower box drawer lock. Connects to returns or bridges with a 16" throat. Corner has one grommet. Top overhangs 2 1/4".

- 84" wide desks are shipped RTA (ready to assemble) in 2 cartons.

Required Specifications

Top finish
Top/edge detail
Lock finish
Base finish

Optional Specifications

HP laminate
Key #
Grommet position or power block cut-out
Handles
Modesty panel type

Accessories

Power block
Keyboard
Pencil drawer

LEFT EXTENDED CORNERS (DOES NOT CONNECT)

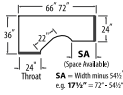
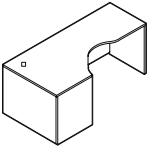

Left Extended Corner, 24" Throat Freestanding

MODEL#	DIMENSIONS D x W x H	FREIGHT CLASS	WT/LBS.	CUBIC FT.	1"TOP	1.5" TOP	GLAZE ADD	HP ADD
Z2472FFL	36 x 72 x 29-29.5	65	184	7	\$882	\$997	N/A	\$387
Z2466FFL	36 x 66 x 29-29.5	65	175	7	\$882	\$992	N/A	\$387

Extended worksurface on right. **Full end panels on left and right. Cannot be connected on left or right, due to full end panel.** Corner has one grommet. Shipped RTA (ready to assemble).

- **Modesty Panel is 1" off of ground.**
- **Z2466FFL cannot accept pedestals**

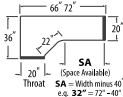
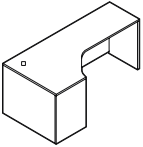

Left Extended Corner, 20" Throat

Z2072FFL	36 x 72 x 29-29.5	65	171	7	\$857	\$991	N/A	\$371
Z2066FFL	36 x 66 x 29-29.5	65	164	7	\$857	\$966	N/A	\$371

Extended worksurface on right. **Full end panels on left and right. Can be placed next to** lateral files, storage cabinets, wardrobe units, credenzas and end-shelves. Corner has one grommet. Shipped RTA (ready to assemble).

- **Modesty Panel is 1" off of ground.**

LEFT EXTENDED CORNERS (CONNECTS ON EXTENDED SIDE)

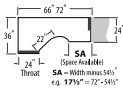
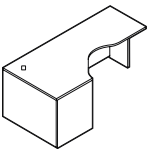

Left Extended Corner, 24" Throat

Z2472FNL	36 x 72 x 29-29.5	65	175	7	\$857	\$972	N/A	\$387
Z2466FNL	36 x 66 x 29-29.5	65	167	7	\$857	\$966	N/A	\$387

Extended worksurface on right. **Narrow end panel on right. Full end panel on left.** Connects to 30"D space saver connectables, 24"D returns, 24"D connectable tables or "D" and "P" islands with "T" or "H" bases. **Full end panel can be placed next to** lateral files, storage cabinets, wardrobe units, credenzas and end-shelves. Corner has one grommet. Shipped RTA (ready to assemble).

- **Modesty Panel is 1" off of ground.**
- **Z2466FNL cannot accept pedestals.**

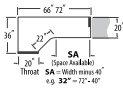
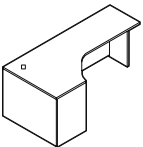

Left Extended Corner, 20" Throat

Z2072FNL	36 x 72 x 29-29.5	65	165	7	\$832	\$966	N/A	\$371
Z2066FNL	36 x 66 x 29-29.5	65	158	7	\$832	\$941	N/A	\$371

Extended worksurface on right. **Narrow end panel on right. Full end panel on left.** Connects to 24"D space saver connectables, 20"D returns, 20"D connectable tables or "D" and "P" islands with "T" or "H" bases. **Full end panel can be placed next to** lateral files, storage cabinets, wardrobe units, credenzas and end-shelves. Corner has one grommet. Shipped RTA (ready to assemble).

- **Modesty Panel is 1" off of ground.**
- **FNL end panels can be switched to make NFL.**

LEFT EXTENDED CORNERS (CONNECTS ON THROAT SIDE)

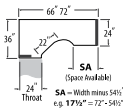
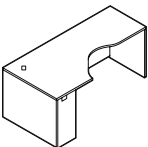

Left Extended Corner, 24" Throat

Z2472NFL	36 x 72 x 29-29.5	65	175	7	\$857	\$972	N/A	\$387
Z2466NFL	36 x 66 x 29-29.5	65	167	7	\$857	\$966	N/A	\$387

Extended worksurface on right. **Narrow end panel on left. Full end panel on right.** Connects to 30"D space saver connectables, 30"D space saver returns, 24"D returns or 24"D connectable tables. **Full end panel can be placed next to** lateral files, storage cabinets, wardrobe units, credenzas and end-shelves. Corner has one grommet. Shipped RTA (ready to assemble).

- **Modesty Panel is 1" off of ground.**
- **Z2466NFL cannot accept pedestals.**

Required Specifications

Top finish
Top/edge detail
Base finish

Optional Specifications

HP laminate
Modesty panel type
Grommet position or power block cut-out

Accessories

Power block
Keyboard
Pencil drawer

LEFT EXTENDED CORNERS (CONNECTS ON THROAT SIDE)

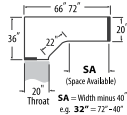
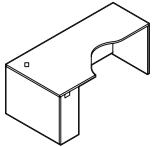

Left Extended Corner, 20" Throat

MODEL#	DIMENSIONS	FREIGHT CLASS	WT/LBS.	CUBIC FT.	1" TOP	1.5" TOP	GLAZE ADD	HP ADD
Z2072NFL	36 x 72 x 29-29.5	65	165	7	\$832	\$966	N/A	\$387
Z2066NFL	36 x 66 x 29-29.5	65	158	7	\$832	\$941	N/A	\$371

Extended worksurface on right. **Narrow end panel on left. Full end panel on right.** Connects to 24"D space saver connectables and 20"D returns. **Full end panel can be placed next to** lateral files, storage cabinets, wardrobe units, credenzas and end-shelves. Corner has one grommet. Shipped RTA (ready to assemble).

- Modesty Panel is 1" off of ground.
- NFL end panels can be switched to make FNL.

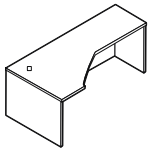
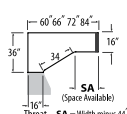
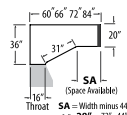
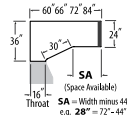

Left Extended Corner, 16" Throat

Z2484ECFL	36 x 84 x 29-29.5	65	196.35	8	\$860	\$1061	N/A	\$538
Z2472ECFL	36 x 72 x 29-29.5	65	176.40	7.50	\$769	\$945	N/A	\$404
Z2466ECFL	36 x 66 x 29-29.5	70	168	7.50	\$732	\$895	N/A	\$404
Z2460ECFL	36 x 60 x 29-29.5	65	158.55	6	\$696	\$847	N/A	\$336
Z2084ECFL	36 x 84 x 29-29.5	65	184.80	8	\$857	\$1059	N/A	\$538
Z2072ECFL	36 x 72 x 29-29.5	70	168	7.50	\$766	\$943	N/A	\$404
Z2066ECFL	36 x 66 x 29-29.5	70	159.60	7.50	\$729	\$893	N/A	\$404
Z2060ECFL	36 x 60 x 29-29.5	65	151.20	6	\$682	\$829	N/A	\$336
Z1684ECFL	36 x 84 x 29-29.5	70	175.35	8	\$854	\$1056	N/A	\$538
Z1672ECFL	36 x 72 x 29-29.5	70	159.60	7.50	\$763	\$940	N/A	\$404
Z1666ECFL	36 x 66 x 29-29.5	70	153.30	7.50	\$726	\$890	N/A	\$404
Z1660ECFL	36 x 60 x 29-29.5	65	147	6	\$677	\$823	N/A	\$336

Extended worksurface on right. **No narrow end panel on left. Full end panel on right.** Connects to returns and bridges with 16" throat on the left. **Full end panel can be placed next to** lateral files, storage cabinets, wardrobe units, credenzas and end-shelves. Corner has one grommet. **Does not accept pencil drawers.** Shipped RTA (ready to assemble).

LEFT EXTENDED CORNERS (CONNECTS ON BOTH SIDES)

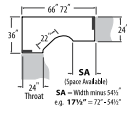
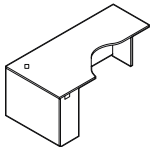

Left Extended Corner, 24" Throat

Z2472NNL	36 x 72 x 29-29.5	65	166	7	\$832	\$947	N/A	\$387
Z2466NNL	36 x 66 x 29-29.5	65	158	7	\$832	\$941	N/A	\$387

Extended worksurface on right. **Narrow end panels on left and right.** Connects to 30"D space saver connectables, 30"D space saver returns, 24"D returns or 24"D connectable tables or "D" and "P" islands with "T" or "H" bases on either end. **Full end panel can be placed next to** lateral files, storage cabinets, wardrobe units, credenzas and end-shelves. Corner has one grommet. Shipped RTA (ready to assemble).

- Modesty Panel is 1" off of ground.
- Z2466NNL cannot accept pedestals.

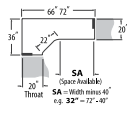
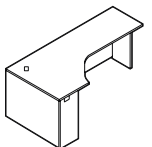

Left Extended Corner, 20" Throat

Z2072NNL	36 x 72 x 29-29.5	65	160	7	\$806	\$940	N/A	\$387
Z2066NNL	36 x 66 x 29-29.5	70	152	7	\$806	\$916	N/A	\$371

Extended worksurface on right. **Narrow end panels on left and right.** Connects to 24"D space saver connectables and 20"D returns, bridges or "D" and "P" islands with "T" or "H" bases one either end. **Full end panel can be placed next to** lateral files, storage cabinets, wardrobe units, credenzas and end-shelves. Corner has one grommet. Shipped RTA (ready to assemble).

- Modesty Panel is 1" off of ground.

Required Specifications

Top finish
Top/edge detail
Base finish

Optional Specifications

HP laminate
Modesty panel type
Grommet position or power block cut-out

Accessories

Power block
Keyboard (Not available on 16" throat)
Pencil drawer (Not available on 16" throat)

LEFT EXTENDED CORNERS (DOES NOT CONNECT)

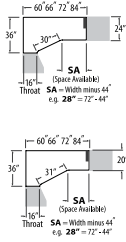
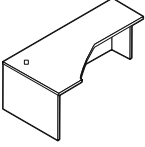

Left Extended Corner, 16" Throat

MODEL#	DIMENSIONS	FREIGHT CLASS	WT./LBS.	CUBIC FT.	1" TOP	1.5" TOP	GLAZE ADD	HP ADD
	D x W x H							
Z2484ECNL	36 x 84 x 29-29.5	65	186.90	8	\$835	\$1037	N/A	\$538
Z2472ECNL	36 x 72 x 29-29.5	70	168	7.50	\$743	\$921	N/A	\$404
Z2466ECNL	36 x 66 x 29-29.5	70	158.55	7.50	\$706	\$869	N/A	\$404
Z2460ECNL	36 x 60 x 29-29.5	65	150.15	6	\$661	\$807	N/A	\$336
Z2084ECNL	36 x 84 x 29-29.5	70	178.50	8	\$832	\$1034	N/A	\$538
Z2072ECNL	36 x 72 x 29-29.5	70	161.70	7.50	\$741	\$917	N/A	\$404
Z2066ECNL	36 x 66 x 29-29.5	70	153.30	7.50	\$704	\$867	N/A	\$404
Z2060ECNL	36 x 60 x 29-29.5	65	145.95	6	\$658	\$805	N/A	\$336

Extended worksurface on right. **No narrow end panel on left. Narrow end panel on right.** Connects to returns and bridges with 16" throat on the left. **Full end panel can be placed next to** lateral files, storage cabinets, wardrobe units, credenzas and end-shelves. Corner has one grommet. **Does not accept pencil drawers.** Shipped RTA (ready to assemble).

RIGHT EXTENDED CORNERS (DOES NOT CONNECT)

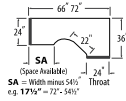
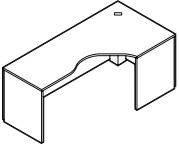

Right Extended Corner, 24" Throat Freestanding

Z2472FFR	36 x 72 x 29-29.5	65	184	7	\$882	\$997	N/A	\$387
Z2466FFR	36 x 66 x 29-29.5	65	175	7	\$882	\$992	N/A	\$387

Extended worksurface on left. **Full end panels on left and right. Cannot be connected on left or right, due to full end panel.** Corner has one grommet. Shipped RTA (ready to assemble).

- **Modesty Panel is 1" off of ground.**
- **Z2466FFR cannot accept pedestals**

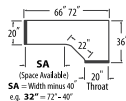
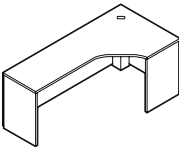

Right Extended Corner, 20" Throat

Z2072FFR	36 x 72 x 29-29.5	65	171	7	\$857	\$991	N/A	\$371
Z2066FFR	36 x 66 x 29-29.5	65	164	7	\$857	\$966	N/A	\$371

Extended worksurface on left. **Full end panels on left and right. Can be placed next to** lateral files, storage cabinets, wardrobe units, credenzas and end-shelves. Corner has one grommet. Shipped RTA (ready to assemble).

- **Modesty Panel is 1" off of ground.**

RIGHT EXTENDED CORNERS (CONNECTS ON THROAT SIDE)

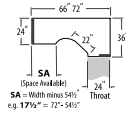
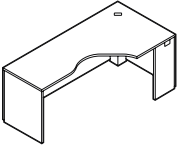

Right Extended Corner, 24" Throat

Z2472FNR	36 x 72 x 29-29.5	65	175	7	\$857	\$972	N/A	\$387
Z2466FNR	36 x 66 x 29-29.5	65	167	7	\$857	\$966	N/A	\$387

Extended worksurface on left. **Narrow end panel on right. Full end panel on left.** Connects to 30"D space saver connectables, 24"D returns, 24"D connectable tables or "D" and "P" islands with "T" or "H" bases. **Full end panel can be placed next to** lateral files, storage cabinets, wardrobe units, credenzas and end-shelves. Corner has one grommet. Shipped RTA (ready to assemble).

- **Modesty Panel is 1" off of ground.**
- **Z2466FNR cannot accept pedestals.**

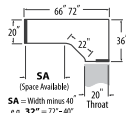
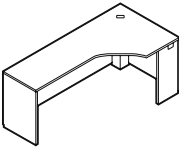

Right Extended Corner, 20" Throat

Z2072FNR	36 x 72 x 29-29.5	65	165	7	\$832	\$966	N/A	\$371
Z2066FNR	36 x 66 x 29-29.5	65	158	7	\$832	\$941	N/A	\$371

Extended worksurface on left. **Narrow end panel on right. Full end panel on left.** Connects to 24"D space saver connectables, 20"D returns, 20"D connectable tables or "D" and "P" islands with "T" or "H" bases. **Full end panel can be placed next to** lateral files, storage cabinets, wardrobe units, credenzas and end-shelves. Corner has one grommet. Shipped RTA (ready to assemble).

- **Modesty Panel is 1" off of ground.**
- **FNR end panels can be switched to make NFR.**

Required Specifications

Top finish
Top/edge detail
Base finish

Optional Specifications

HP laminate
Modesty panel type
Grommet position or power block cut-out

Accessories

Power block
Keyboard (*Not available on 16" throat*)
Pencil drawer (*Not available on 16" throat*)

RIGHT EXTENDED CORNERS (CONNECTS ON THROAT SIDE)

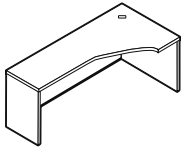
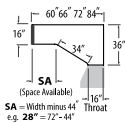
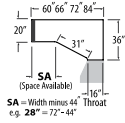
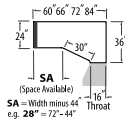

Right Extended Corner, 16" Throat

MODEL#	DIMENSIONS	FREIGHT CLASS	WT./LBS.	CUBIC FT.	1" TOP	1.5" TOP	GLAZE ADD	HP ADD
D x W x H								
Z2484ECFR	36 x 84 x 29-29.5	65	196.35	8	\$860	\$1061	N/A	\$538
Z2472ECFR	36 x 72 x 29-29.5	65	176.40	7.50	\$769	\$945	N/A	\$404
Z2466ECFR	36 x 66 x 29-29.5	70	168	7.50	\$732	\$895	N/A	\$404
Z2460ECFR	36 x 60 x 29-29.5	65	158.55	6	\$696	\$847	N/A	\$336
Z2084ECFR	36 x 84 x 29-29.5	65	184.80	8	\$857	\$1059	N/A	\$538
Z2072ECFR	36 x 72 x 29-29.5	70	168	7.50	\$766	\$943	N/A	\$404
Z2066ECFR	36 x 66 x 29-29.5	70	159.60	7.50	\$729	\$893	N/A	\$404
Z2060ECFR	36 x 60 x 29-29.5	65	151.20	6	\$682	\$829	N/A	\$336
Z1684ECFR	36 x 84 x 29-29.5	70	175.35	8	\$854	\$1056	N/A	\$538
Z1672ECFR	36 x 72 x 29-29.5	70	159.60	7.50	\$763	\$940	N/A	\$404
Z1666ECFR	36 x 66 x 29-29.5	70	153.30	7.50	\$726	\$890	N/A	\$404
Z1660ECFR	36 x 60 x 29-29.5	65	147	6	\$677	\$823	N/A	\$336

Extended worksurface on left. **No narrow end panel on right. Full end panel on left.** Connects to returns and bridges with 16" throat on the right. **Full end panel can be placed next to** lateral files, storage cabinets, wardrobe units, credenzas and end-shelves. Corner has one grommet. **Does not accept pencil drawers.** Shipped RTA (ready to assemble).

RIGHT EXTENDED CORNERS (CONNECTS ON EXTENDED SIDE)

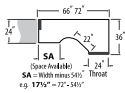
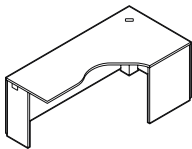

Right Extended Corner, 24" Throat

Z2472NFR	36 x 72 x 29-29.5	65	175	7	\$857	\$972	N/A	\$387
Z2466NFR	36 x 66 x 29-29.5	65	167	7	\$857	\$966	N/A	\$387

Extended worksurface on left. **Narrow end panel on left. Full end panel on right.** Connects to 30"D space saver connectables, 24"D returns, 24"D connectable tables, or "D" and "P" islands with "T" or "H" bases. **Full end panel can be placed next to** lateral files, storage cabinets, wardrobe units, credenzas and end-shelves. Corner has one grommet. Shipped RTA (ready to assemble).

- **Modesty Panel is 1" off of ground.**
- **Z2466NFR cannot accept pedestals.**

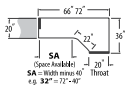
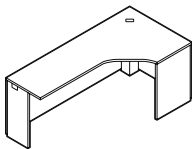

Right Extended Corner, 20" Throat

Z2072NFR	36 x 72 x 29-29.5	65	165	7	\$832	\$966	N/A	\$387
Z2066NFR	36 x 66 x 29-29.5	65	158	7	\$832	\$941	N/A	\$371

Extended worksurface on left. **Narrow end panel on left. Full end panel on right.** Connects to 24"D space saver connectables, 20"D returns or "D" and "P" islands with "T" or "H" bases. **Full end panel can be placed next to** lateral files, storage cabinets, wardrobe units, credenzas and end-shelves. Corner has one grommet. Shipped RTA (ready to assemble).

- **Modesty Panel is 1" off of ground.**
- **NFR end panels can be switched to make FNR.**

RIGHT EXTENDED CORNERS (CONNECTS ON BOTH SIDES)

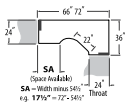
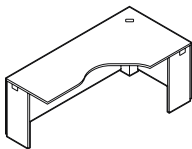

Left Extended Corner, 24" Throat

Z2472NNR	36 x 72 x 29-29.5	65	166	7	\$832	\$947	N/A	\$387
Z2466NNR	36 x 66 x 29-29.5	65	158	7	\$832	\$941	N/A	\$387

Extended worksurface on left. **Narrow end panels on left and right.** Connects to 30"D space saver connectables, 30"D space saver returns, 24"D returns, 24"D connectable tables or "D" and "P" islands with "T" or "H" bases on either end. Corner has one grommet. Shipped RTA (ready to assemble).

- **Modesty Panel is 1" off of ground.**
- **Z2466NNR cannot accept pedestals.**

Required Specifications

Top finish
Top/edge detail
Base finish

Optional Specifications

HP laminate
Modesty panel type
Grommet position or power block cut-out

Accessories

Power block
Keyboard (*Not available on 16" throat*)
Pencil drawer (*Not available on 16" throat*)

RIGHT EXTENDED CORNERS (CONNECTS ON BOTH SIDES)

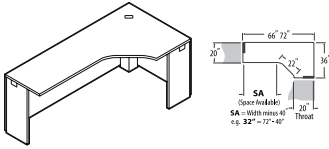

Right Extended Corner, 20" Throat

MODEL#	DIMENSIONS D x W x H	FREIGHT CLASS	WT./LBS.	CUBIC FT.	1" TOP	1.5" TOP	GLAZE ADD	HP ADD
Z2072NNR	36 x 72 x 29-29.5	65	160	7	\$806	\$940	N/A	\$387
Z2066NNR	36 x 66 x 29-29.5	70	152	7	\$806	\$906	N/A	\$371

Extended worksurface on left. **Narrow end panels on left and right.** Connects to 24"D space saver connectables and 20"D returns, bridges or "D" and "P" islands with "T" or "H" bases one either end. **Full end panel can be placed next to** lateral files, storage cabinets, wardrobe units, credenzas and end-shelves. Corner has one grommet. Shipped RTA (ready to assemble).

- Modesty Panel is 1" off of ground.

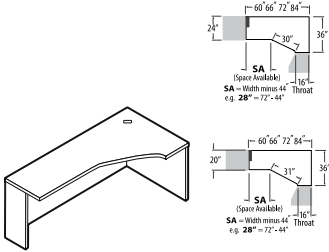

Right Extended Corner, 16" Throat

Z2484ECNR	36 x 84 x 29-29.5	65	186.90	8	\$835	\$1037	N/A	\$538
Z2472ECNR	36 x 72 x 29-29.5	70	168	7.50	\$743	\$921	N/A	\$404
Z2466ECNR	36 x 66 x 29-29.5	70	158.55	7.50	\$706	\$869	N/A	\$404
Z2460ECNR	36 x 60 x 29-29.5	65	150.15	6	\$661	\$807	N/A	\$336
Z2084ECNR	36 x 84 x 29-29.5	70	178.50	8	\$832	\$1034	N/A	\$538
Z2072ECNR	36 x 72 x 29-29.5	70	161.70	7.50	\$741	\$917	N/A	\$404
Z2066ECNR	36 x 66 x 29-29.5	70	153.30	7.50	\$704	\$867	N/A	\$404
Z2060ECNR	36 x 60 x 29-29.5	65	145.95	6	\$658	\$805	N/A	\$336

Extended worksurface on left. **No narrow end panel on right. Narrow end panel on left.** Connects to returns and bridges with 16" throat on the right. **Full end panel can be placed next to** lateral files, storage cabinets, wardrobe units, credenzas and end-shelves. Corner has one grommet. **Does not accept pencil drawers.** Shipped RTA (ready to assemble).

FREESTANDING TABLES

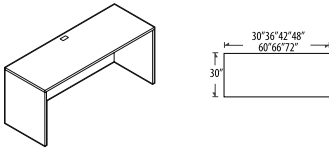

30" Deep Freestanding Table

Z3072T	29.69 x 72 x 29-29.5	65	176	6	\$730	\$842	N/A	\$362
Z3066T	29.69 x 66 x 29-29.5	65	166	6	\$730	\$835	N/A	\$362
Z3060T	29.69 x 60 x 29-29.5	60	159	5.25	\$666	\$765	N/A	\$336
Z3048T	29.69 x 48 x 29-29.5	65	135	5.25	\$601	\$689	N/A	\$285
Z3042T	29.69 x 42 x 29-29.5	65	125	5.25	\$601	\$682	N/A	\$258
Z3036T	29.69 x 36 x 29-29.5	65	111	4.30	\$532	\$606	N/A	\$233
Z3030T	29.69 x 30 x 29-29.5	65	100	3.60	\$499	\$561	N/A	\$207

Two full end panels. Cannot be connected on left or right side. Grommet in worksurface. Shipped RTA (ready to assemble).

- Modesty Panel is 1" off of ground.

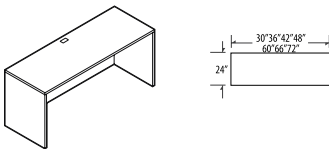

24" Deep Freestanding Table

Z2472T	24 x 72 x 29-29.5	65	152	6	\$654	\$759	N/A	\$269
Z2466T	24 x 66 x 29-29.5	65	144	6	\$654	\$759	N/A	\$269
Z2460T	24 x 60 x 29-29.5	65	133	5.25	\$596	\$676	N/A	\$248
Z2448T	24 x 48 x 29-29.5	65	114	4.30	\$537	\$606	N/A	\$197
Z2442T	24 x 42 x 29-29.5	65	105	4.30	\$537	\$599	N/A	\$165
Z2436T	24 x 36 x 29-29.5	65	95	4.20	\$480	\$531	N/A	\$124
Z2430T	24 x 30 x 29-29.5	65	85	3.60	\$455	\$492	N/A	\$124

Two full end panels. Cannot be connected on left or right side. Grommet in worksurface. Shipped RTA (ready to assemble).

- Modesty Panel is 1" off of ground.

Required Specifications

Top finish
Top/edge detail
Base finish

Optional Specifications

HP laminate
Modesty panel type
Grommet position or power block cut-out

Accessories

Power block
Keyboard (Not available on 16" throat)
Pencil drawer (Not available on 16" throat)

CONNECTABLE TABLES - LEFT

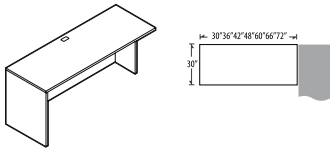

30" Deep Connectable Table - Left

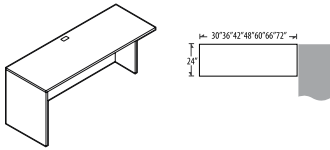

24" Deep Connectable Table - Left

MODEL#	DIMENSIONS	FREIGHT CLASS	WT/LBS.	CUBIC FT.	1" TOP	1.5" TOP	GLAZE ADD	HP ADD
D x W x H								
Z3072L	29.69 x 72 x 29-29.5	65	168	6	\$704	\$816	N/A	\$362
Z3066L	29.69 x 66 x 29-29.5	65	158	6	\$704	\$809	N/A	\$362
Z3060L	29.69 x 60 x 29-29.5	65	150	5.25	\$640	\$739	N/A	\$336
Z3048L	29.69 x 48 x 29-29.5	65	124	4.30	\$576	\$664	N/A	\$285
Z3042L	29.69 x 42 x 29-29.5	65	115	4.30	\$576	\$657	N/A	\$258
Z3036L	29.69 x 36 x 29-29.5	65	103	4.20	\$507	\$582	N/A	\$233
Z3030L	29.69 x 30 x 29-29.5	65	92	3.60	\$474	\$536	N/A	\$207

Full end panel on left. Right narrow end panel connects to **30"D** center/right connectable table, or at 90° angle to a freestanding table; and "D" islands or "P" islands with "T" and "H" bases. Grommet in worksurface. Shipped RTA (ready to assemble).

- Modesty Panel is 1" off of ground.

Z2472L	24 x 72 x 29-29.5	65	144	6	\$621	\$728	N/A	\$269
Z2466L	24 x 66 x 29-29.5	65	135	6	\$621	\$715	N/A	\$269
Z2460L	24 x 60 x 29-29.5	65	125	5.25	\$563	\$644	N/A	\$248
Z2448L	24 x 48 x 29-29.5	65	106	4.30	\$513	\$582	N/A	\$197
Z2442L	24 x 42 x 29-29.5	65	95	3.80	\$513	\$575	N/A	\$165
Z2436L	24 x 36 x 29-29.5	65	86	3.30	\$449	\$499	N/A	\$124
Z2430L	24 x 30 x 29-29.5	70	77	3.60	\$423	\$461	N/A	\$124

Full end panel on left. Right narrow end panel connects to **24"D** center/right connectable table, or at 90° angle to a freestanding table; 24"D extended corners or at the end of a straight run; "D" islands or "P" islands with "T" and "H" bases. Grommet in worksurface. Shipped RTA (ready to assemble).

- Modesty Panel is 1" off of ground.

CONNECTABLE TABLES - RIGHT

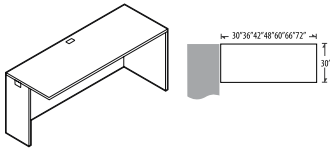

30" Deep Connectable Table - Right

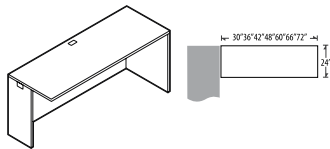

24" Deep Connectable Table - Right

Z3072R	29.69 x 72 x 29-29.5	65	168	6	\$704	\$816	N/A	\$362
Z3066R	29.69 x 66 x 29-29.5	65	158	6	\$704	\$809	N/A	\$362
Z3060R	29.69 x 60 x 29-29.5	65	150	5.25	\$640	\$739	N/A	\$336
Z3048R	29.69 x 48 x 29-29.5	65	124	4.30	\$576	\$664	N/A	\$285
Z3042R	29.69 x 42 x 29-29.5	65	115	4.30	\$576	\$657	N/A	\$258
Z3036R	29.69 x 36 x 29-29.5	65	103	4.20	\$507	\$582	N/A	\$233
Z3030R	29.69 x 30 x 29-29.5	65	92	3.60	\$474	\$536	N/A	\$207

Full end panel on right. Left narrow end panel connects to **30"D** center/right connectable table, or at 90° angle to a freestanding table; and "D" islands or "P" islands with "T" and "H" bases. Grommet in worksurface. Shipped RTA (ready to assemble).

- Modesty Panel is 1" off of ground.

Z2472R	24 x 72 x 29-29.5	65	144	6	\$621	\$728	N/A	\$269
Z2466R	24 x 66 x 29-29.5	65	135	6	\$621	\$715	N/A	\$269
Z2460R	24 x 60 x 29-29.5	65	125	5.25	\$563	\$644	N/A	\$248
Z2448R	24 x 48 x 29-29.5	65	106	4.30	\$513	\$582	N/A	\$197
Z2442R	24 x 42 x 29-29.5	65	95	3.80	\$513	\$575	N/A	\$165
Z2436R	24 x 36 x 29-29.5	65	86	3.30	\$449	\$499	N/A	\$124
Z2430R	24 x 30 x 29-29.5	70	77	3.60	\$423	\$461	N/A	\$124

Full end panel on right. Left narrow end panel connects to **24"D** center/right connectable table, or at 90° angle to a freestanding table; 24"D extended corners or at the end of a straight run; "D" islands or "P" islands with "T" and "H" bases. Grommet in worksurface. Shipped RTA (ready to assemble).

- Modesty Panel is 1" off of ground.

Required Specifications

Top finish
Top/edge detail
Base finish

Optional Specifications

HP laminate
Modesty panel type
Grommet position or power block cut-out

Accessories

Power block
Keyboard
Pencil drawer

CONNECTABLE TABLES

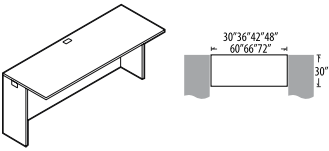

30" Deep Connectable Table

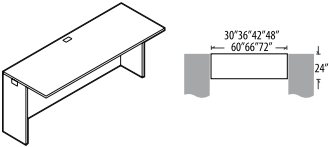

24" Deep Connectable Table

MODEL#	DIMENSIONS	FREIGHT CLASS	WT./LBS.	CUBIC FT.	1" TOP	1.5" TOP	GLAZE ADD	HP ADD
D x W x H								
Z3072N	29.69 x 72 x 29-29.5	65	159	6	\$678	\$791	N/A	\$362
Z3066N	29.69 x 66 x 29-29.5	65	149	6	\$678	\$785	N/A	\$362
Z3060N	29.69 x 60 x 29-29.5	65	142	5.25	\$607	\$707	N/A	\$336
Z3048N	29.69 x 48 x 29-29.5	65	116	4.30	\$532	\$619	N/A	\$285
Z3042N	29.69 x 42 x 29-29.5	65	106	3.80	\$532	\$612	N/A	\$258
Z3036N	29.69 x 36 x 29-29.5	65	94	3.30	\$474	\$549	N/A	\$233
Z3030N	29.69 x 30 x 29-29.5	65	83	3.60	\$449	\$511	N/A	\$207

Narrow end panels on both sides connect to 30"D worksurfaces, "D" islands or "P" islands with "T" and "H" bases; or at 90° angle to freestanding table(s). Grommet in worksurface. Shipped RTA (ready to assemble).

• Modesty Panel is 1" off of ground.

Z2472N	24 x 72 x 29-29.5	65	135	6	\$590	\$695	N/A	\$269
Z2466N	24 x 66 x 29-29.5	70	127	6	\$590	\$683	N/A	\$269
Z2460N	24 x 60 x 29-29.5	65	116	4.50	\$532	\$612	N/A	\$248
Z2448N	24 x 48 x 29-29.5	65	97	4.30	\$480	\$549	N/A	\$197
Z2442N	24 x 42 x 29-29.5	65	87	3.80	\$480	\$537	N/A	\$165
Z2436N	24 x 36 x 29-29.5	65	77	3.30	\$416	\$466	N/A	\$124
Z2430N	24 x 30 x 29-29.5	70	68	3.60	\$391	\$428	N/A	\$124

Narrow end panels on both sides connect to 24"D worksurfaces, "D" islands or "P" islands with "T" and "H" bases; or at 90° angle to freestanding table(s). Grommet in worksurface. Shipped RTA (ready to assemble).

• Modesty Panel is 1" off of ground.

SPACE SAVER CONNECTABLE TABLES - LEFT

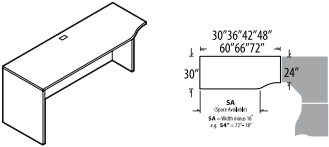

30" Deep Space Saver Connectable Table - Left

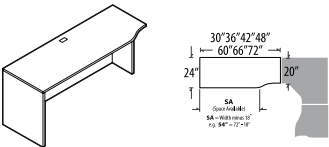

24" Deep Space Saver Connectable Table - Left

Z3072LK	29.69 x 72 x 29-29.5	65	161	6	\$717	\$838	N/A	\$362
Z3066LK	29.69 x 66 x 29-29.5	65	151	6	\$717	\$832	N/A	\$362
Z3060LK	29.69 x 60 x 29-29.5	65	144	5.25	\$654	\$763	N/A	\$336
Z3048LK	29.69 x 48 x 29-29.5	65	118	4.30	\$590	\$686	N/A	\$285
Z3042LK	29.69 x 42 x 29-29.5	65	107	3.80	\$590	\$680	N/A	\$258
Z3036LK	29.69 x 36 x 29-29.5	70	96	4.30	\$519	\$602	N/A	\$233
Z3030LK	29.69 x 30 x 29-29.5	65	85	3.60	\$487	\$559	N/A	\$207

Full end panel on left. Narrow right end panel connects to any corner unit with a 24" throat. Grommet in worksurface. Shipped RTA (ready to assemble).

• Modesty Panel is 1" off of ground.

Z2472LK	29.69 x 72 x 29-29.5	65	140	6	\$640	\$755	N/A	\$269
Z2466LK	29.69 x 66 x 29-29.5	70	134	6	\$640	\$742	N/A	\$269
Z2460LK	29.69 x 60 x 29-29.5	65	123	5.25	\$583	\$673	N/A	\$248
Z2448LK	29.69 x 48 x 29-29.5	65	104	4.30	\$532	\$609	N/A	\$197
Z2442LK	29.69 x 42 x 29-29.5	65	94	3.80	\$532	\$603	N/A	\$165
Z2436LK	29.69 x 36 x 29-29.5	65	85	3.30	\$467	\$527	N/A	\$124
Z2430LK	29.69 x 30 x 29-29.5	70	75	3.60	\$443	\$490	N/A	\$124

Full end panel on left. Narrow right end panel connects to any corner unit with a 20" throat. Grommet in worksurface. Shipped RTA (ready to assemble).

• Modesty Panel is 1" off of ground.

Required Specifications

Top finish
Top/edge detail
Base finish

Optional Specifications

HP laminate
Modesty panel type
Grommet position or power block cut-out

Accessories

Power block
Keyboard
Pencil drawer

SPACE SAVER CONNECTABLE TABLES - RIGHT

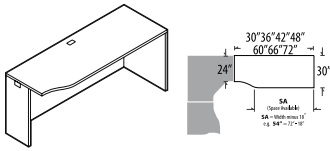

30" Deep Space Saver Connectable Table - Right

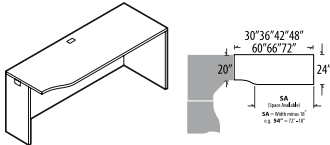

24" Deep Space Saver Connectable Table - Right

MODEL#	DIMENSIONS	FREIGHT CLASS	WT/LBS.	CUBIC FT.	1" TOP	1.5" TOP	GLAZE ADD	HP ADD
D x W x H								
Z3072RK	29.69 x 72 x 29-29.5	65	161	6	\$717	\$838	N/A	\$362
Z3066RK	29.69 x 66 x 29-29.5	65	151	6	\$717	\$832	N/A	\$362
Z3060RK	29.69 x 60 x 29-29.5	65	144	5.25	\$654	\$763	N/A	\$336
Z3048RK	29.69 x 48 x 29-29.5	65	119	4.30	\$590	\$686	N/A	\$285
Z3042RK	29.69 x 42 x 29-29.5	65	107	3.80	\$590	\$680	N/A	\$258
Z3036RK	29.69 x 36 x 29-29.5	70	96	4.30	\$519	\$602	N/A	\$233
Z3030RK	29.69 x 30 x 29-29.5	65	85	3.60	\$487	\$559	N/A	\$207

Full end panel on right. Narrow left end panel connects to any corner unit with a 24" throat. Grommet in worksurface. Shipped RTA (ready to assemble).

- Modesty Panel is 1" off of ground.

Z2472RK	29.69 x 72 x 29-29.5	65	142	6	\$640	\$755	N/A	\$269
Z2466RK	29.69 x 66 x 29-29.5	70	134	6	\$640	\$742	N/A	\$269
Z2460RK	29.69 x 60 x 29-29.5	65	123	5.25	\$583	\$673	N/A	\$248
Z2448RK	29.69 x 48 x 29-29.5	65	104	4.30	\$532	\$595	N/A	\$197
Z2442RK	29.69 x 42 x 29-29.5	65	94	3.80	\$532	\$603	N/A	\$165
Z2436RK	29.69 x 36 x 29-29.5	65	85	3.30	\$467	\$527	N/A	\$124
Z2430RK	29.69 x 30 x 29-29.5	70	75	3.60	\$443	\$490	N/A	\$124

Full end panel on right. Narrow left end panel connects to any corner unit with a 20" throat. Grommet in worksurface. Shipped RTA (ready to assemble).

- Modesty Panel is 1" off of ground.

SPACE SAVER CONNECTABLE TABLES

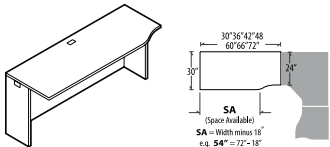

30" Deep Space Saver Connectable Table

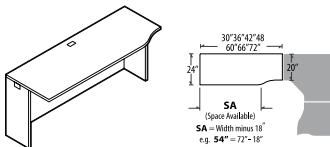

24" Deep Space Saver Connectable Table

Z3072LN	29.69 x 72 x 29-29.5	65	153	6	\$691	\$812	N/A	\$362
Z3066LN	29.69 x 66 x 29-29.5	65	143	6	\$691	\$806	N/A	\$362
Z3060LN	29.69 x 60 x 29-29.5	65	136	5.25	\$621	\$731	N/A	\$336
Z3048LN	29.69 x 48 x 29-29.5	65	110	4.30	\$544	\$641	N/A	\$285
Z3042LN	29.69 x 42 x 29-29.5	65	100	3.80	\$544	\$635	N/A	\$258
Z3036LN	29.69 x 36 x 29-29.5	65	88	3.30	\$487	\$571	N/A	\$233
Z3030LN	29.69 x 30 x 29-29.5	70	77	3.60	\$461	\$533	N/A	\$207

Narrow end panels on both sides. Connects the **right end only** to any corner unit with a 24" throat. Left end allows the continuation of additional 30" connectable center or left connectable worksurface. Grommet in worksurface. Shipped RTA (ready to assemble).

- Modesty Panel is 1" off of ground.

Z2472LN	24 x 72 x 29-29.5	70	134	6	\$607	\$723	N/A	\$269
Z2466LN	24 x 66 x 29-29.5	70	125	6	\$607	\$710	N/A	\$269
Z2460LN	24 x 60 x 29-29.5	70	115	5.25	\$551	\$648	N/A	\$248
Z2448LN	24 x 48 x 29-29.5	70	96	4.30	\$499	\$577	N/A	\$197
Z2442LN	24 x 42 x 29-29.5	70	85	3.80	\$499	\$571	N/A	\$165
Z2436LN	24 x 36 x 29-29.5	65	76	3.30	\$436	\$495	N/A	\$124
Z2430LN	24 x 30 x 29-29.5	70	67	3.60	\$410	\$458	N/A	\$124

Narrow end panels on both sides. Connects the **right end only** to any corner unit with a 24" throat. Left end allows the continuation of additional 24" connectable center or left connectable worksurface. Grommet in worksurface. Shipped RTA (ready to assemble).

- Modesty Panel is 1" off of ground.

Required Specifications

Top finish
Top/edge detail
Base finish

Optional Specifications

HP laminate
Modesty panel type
Grommet position or power block cut-out

Accessories

Power block
Keyboard
Pencil drawer

SPACE SAVER CONNECTABLE TABLES

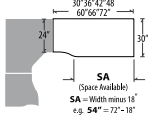
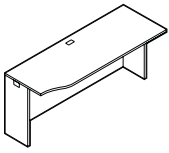

30" Deep Space Saver Connectable Table

MODEL#	DIMENSIONS D x W x H	FREIGHT CLASS	WT./LBS.	CUBIC FT.	1" TOP	1.5" TOP	GLAZE ADD	HP ADD
Z3072RN	29.69 x 72 x 29-29.5	65	153	6	\$691	\$812	N/A	\$362
Z3066RN	29.69 x 66 x 29-29.5	65	143	6	\$691	\$806	N/A	\$362
Z3060RN	29.69 x 60 x 29-29.5	65	136	5.25	\$621	\$731	N/A	\$336
Z3048RN	29.69 x 48 x 29-29.5	65	110	4.30	\$544	\$641	N/A	\$285
Z3042RN	29.69 x 42 x 29-29.5	65	99	3.80	\$544	\$635	N/A	\$258
Z3036RN	29.69 x 36 x 29-29.5	65	88	3.30	\$487	\$571	N/A	\$233
Z3030RN	29.69 x 30 x 29-29.5	70	77	3.60	\$461	\$533	N/A	\$207

Narrow end panels on both sides. Connects the **left end only** to any corner unit with a 24" throat. Right end allows the continuation of additional 30" connectable center or right connectable worksurface. Grommet in worksurface. Shipped RTA (ready to assemble).

- Modesty Panel is 1" off of ground.

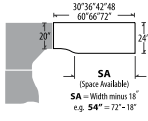
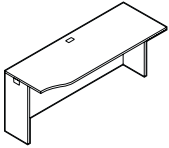

24" Deep Space Saver Connectable Table

Z2472RN	24 x 72 x 29-29.5	70	134	6	\$607	\$723	N/A	\$269
Z2466RN	24 x 66 x 29-29.5	70	125	6	\$607	\$710	N/A	\$269
Z2460RN	24 x 60 x 29-29.5	70	115	5.25	\$551	\$648	N/A	\$248
Z2448RN	24 x 48 x 29-29.5	70	95	4.30	\$499	\$577	N/A	\$197
Z2442RN	24 x 42 x 29-29.5	70	85	3.80	\$499	\$571	N/A	\$165
Z2436RN	24 x 36 x 29-29.5	65	76	3.30	\$436	\$495	N/A	\$124
Z2430RN	24 x 30 x 29-29.5	70	67	3.60	\$410	\$458	N/A	\$124

Narrow end panels on both sides. Connects the **left end only** to any corner unit with a 20" throat. Right end allows the continuation of additional 30" connectable center or right connectable worksurface. Grommet in worksurface. Shipped RTA (ready to assemble).

- Modesty Panel is 1" off of ground.

EXTENDED CORNER ISLANDS

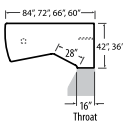
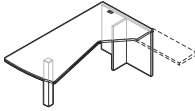

Extended Corner Island - LEFT
Full End Panel & Post (T-Base)*

Z4284EDTL	42 x 84 x 29-29.5	100	180.60	10.75	\$868	\$1092	N/A	\$717
Z4272EDTL	42 x 72 x 29-29.5	100	164.85	9.50	\$816	\$1015	N/A	\$538
Z3672EDTL	36 x 72 x 29-29.5	125	139.65	8.75	\$744	\$882	N/A	\$404
Z3666EDTL	36 x 66 x 29-29.5	125	133.35	8.75	\$713	\$849	N/A	\$404
Z3660EDTL	36 x 60 x 29-29.5	100	127.05	6.50	\$679	\$817	N/A	\$336

Extended island worksurface on **left**. Connects to returns or bridges with a 16" throat on the right. **Not freestanding.** Grommet in worksurface. Shipped RTA (ready to assemble).

- Post is shipped in separate carton.

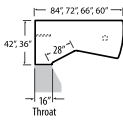
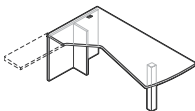

Extended Corner Island - RIGHT
Full End Panel & Post (T-Base)*

Z4284EDTR	42 x 84 x 29-29.5	100	180.60	10.75	\$868	\$1092	N/A	\$717
Z4272EDTR	42 x 72 x 29-29.5	100	164.85	9.50	\$816	\$1015	N/A	\$538
Z3672EDTR	36 x 72 x 29-29.5	125	139.65	8.75	\$744	\$882	N/A	\$404
Z3666EDTR	36 x 66 x 29-29.5	125	133.35	8.75	\$713	\$849	N/A	\$404
Z3660EDTR	36 x 60 x 29-29.5	100	127.05	6.50	\$679	\$817	N/A	\$336

Extended island worksurface on **right**. Connects to returns or bridges with a 16" throat on the left. **Not freestanding.** Grommet in worksurface. Shipped RTA (ready to assemble).

- Post is shipped in separate carton.

Required Specifications

Top finish
Top/edge detail
Base finish
Monopost finish*

Optional Specifications

HP laminate
Modesty panel type
Grommet position or power block cut-out

Accessories

Power block
Keyboard
Pencil drawer

EXTENDED CORNER ISLANDS (WITH FAUX PEDESTAL)

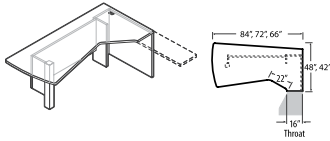

**Extended Corner Island - LEFT
Faux Pedestal and Post**

MODEL#	DIMENSIONS	FREIGHT CLASS	WT/LBS.	CUBIC FT.	1" TOP	1.5" TOP	GLAZE ADD	HP ADD
Z4884EDFL	48 x 84 x 29-29.5	100	214.20	12	\$1087	\$1337	\$486	\$717
Z4872EDFL	48 x 72 x 29-29.5	100	192.15	10.50	\$1007	\$1225	\$401	\$538
Z4284EDFL	42 x 84 x 29-29.5	100	186.90	10.75	\$1020	\$1244	\$486	\$717
Z4272EDFL	42 x 72 x 29-29.5	100	168	8.75	\$948	\$1143	\$401	\$538
Z4266EDFL	42 x 66 x 29-29.5	100	158.55	8.75	\$910	\$1091	\$359	\$538

Extended island worksurface on **left**. Connects to returns or bridges with a 16" throat on the right. **Not freestanding**. Faux pedestal on the **right** is ideal for concealing a CPU. ¾ modesty panel is standard. Grommet in worksurface. Shipped RTA (ready to assemble) in 2 cartons.

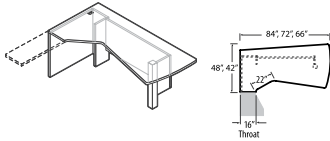

**Extended Corner Island - RIGHT
Faux Pedestal and Post**

Z4884EDFR	48 x 84 x 29-29.5	100	214.20	12	\$1087	\$1337	\$486	\$717
Z4872EDFR	48 x 72 x 29-29.5	100	192.15	10.50	\$1007	\$1225	\$401	\$538
Z4284EDFR	42 x 84 x 29-29.5	100	186.90	10.75	\$1020	\$1244	\$486	\$717
Z4272EDFR	42 x 72 x 29-29.5	100	168	8.75	\$948	\$1143	\$401	\$538
Z4266EDFR	42 x 66 x 29-29.5	100	158.55	8.75	\$910	\$1091	\$359	\$538

Extended island worksurface on **right**. Connects to returns or bridges with a 16" throat on the right. **Not freestanding**. Faux pedestal on the **left** is ideal for concealing a CPU. ¾ modesty panel is standard. Grommet in worksurface. Shipped RTA (ready to assemble) in 2 cartons.



EXTENDED CORNER ISLANDS (WITH RECESSED MODESTY)

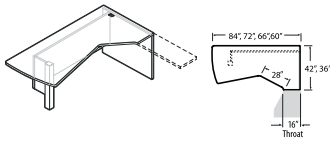

**Extended Corner Island - LEFT
Recessed Modesty and Post**

Z4284EDRL	42 x 84 x 29-29.5	100	199	10.75	\$964	\$1189	\$572	\$717
Z4272EDRL	42 x 72 x 29-29.5	100	180	9.50	\$905	\$1103	\$521	\$538
Z3672EDRL	36 x 72 x 29-29.5	100	154	8.75	\$801	\$969	\$521	\$404
Z3666EDRL	36 x 66 x 29-29.5	100	144	8.75	\$771	\$927	\$479	\$404
Z3660EDRL	36 x 60 x 29-29.5	92.5	136	6.50	\$741	\$885	\$437	\$336

Extended island worksurface on **left**. Connects to returns or bridges with a 16" throat on the right. **Not freestanding**. Grommet in worksurface. ¾ **recessed** modesty panel is standard. Shipped RTA (ready to assemble) in 2 cartons.

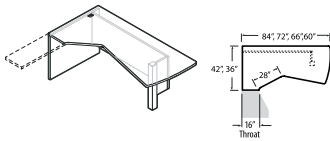

**Extended Corner Island - RIGHT
Recessed Modesty and Post**

Z4284EDRR	42 x 84 x 29-29.5	100	199	10.75	\$964	\$1189	\$572	\$717
Z4272EDRR	42 x 72 x 29-29.5	100	180	9.50	\$905	\$1103	\$521	\$538
Z3672EDRR	36 x 72 x 29-29.5	100	154	8.75	\$801	\$969	\$521	\$404
Z3666EDRR	36 x 66 x 29-29.5	100	144	8.75	\$771	\$927	\$479	\$404
Z3660EDRR	36 x 60 x 29-29.5	92.5	136	6.50	\$741	\$885	\$437	\$336

Extended island worksurface on **right**. Connects to returns or bridges with a 16" throat on the left. **Not freestanding**. Grommet in worksurface. ¾ **recessed** modesty panel is standard. Shipped RTA (ready to assemble) in 2 cartons.

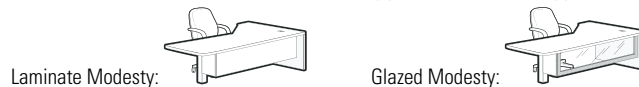

Required Specifications

- Top finish
- Top/edge detail
- Base finish
- Monopost finish

Optional Specifications

- HP laminate
- Glazing - modesty panel
- Grommet position or power block cut-out

Accessories

- Power block
- Keyboard
- Pencil drawer

EXTENDED CORNER ISLANDS (WITH FLUSH MODESTY)

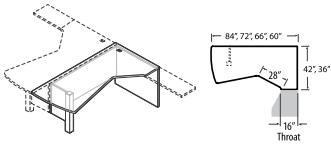

**Extended Corner Island - LEFT
Flush Modesty and Post**

MODEL#	DIMENSIONS D x W x H	FREIGHT CLASS	WT./LBS.	CUBIC FT.	1" TOP	1.5" TOP	GLAZE ADD	HP ADD
Z4284EDML	42 x 84 x 29-29.5	100	208.95	10.75	\$976	\$1201	\$572	\$717
Z4272EDML	42 x 72 x 29-29.5	100	183.75	9.50	\$915	\$1113	\$521	\$538
Z3672EDML	36 x 72 x 29-29.5	100	158.55	8.75	\$809	\$974	\$521	\$404
Z3666EDML	36 x 66 x 29-29.5	100	150.15	8.75	\$776	\$950	\$479	\$404
Z3660EDML	36 x 60 x 29-29.5	92.5	141.75	6.50	\$756	\$891	\$437	\$336

Extended island worksurface on **left**. Connects to returns or bridges with a 16" throat on the right. **Not freestanding.** Grommet in worksurface. $\frac{3}{4}$ flush modesty panel is standard. Shipped RTA (ready to assemble) in 2 cartons.

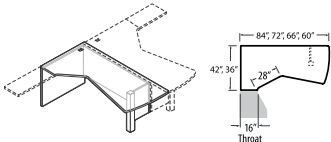

**Extended Corner Island - RIGHT
Flush Modesty and Post**

Z4284EDMR	42 x 84 x 29-29.5	100	208.95	10.75	\$976	\$1201	\$572	\$717
Z4272EDMR	42 x 72 x 29-29.5	100	183.75	9.50	\$915	\$1113	\$521	\$538
Z3672EDMR	36 x 72 x 29-29.5	100	158.55	8.75	\$809	\$974	\$521	\$404
Z3666EDMR	36 x 66 x 29-29.5	100	150.15	8.75	\$776	\$950	\$479	\$404
Z3660EDMR	36 x 60 x 29-29.5	92.5	141.75	6.50	\$756	\$891	\$437	\$336

Extended island worksurface on **right**. Connects to returns or bridges with a 16" throat on the left. **Not freestanding.** Grommet in worksurface. $\frac{3}{4}$ flush modesty panel is standard. Shipped RTA (ready to assemble) in 2 cartons.

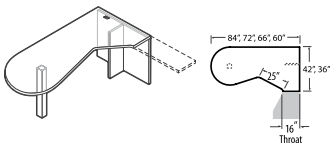
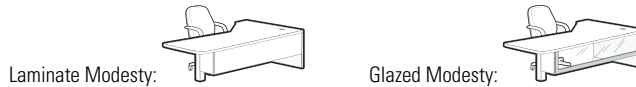

**Extended Corner "P" Island - LEFT
Full End Panel & Post (T-Base)**

Z4284EPTL	42 x 84 x 29-29.5	100	178.50	10.75	\$863	\$1087	N/A	\$717
Z3684EPTL	36 x 84 x 29-29.5	100	153.30	9.50	\$795	\$994	N/A	\$538
Z3672EPTL	36 x 72 x 29-29.5	100	144.90	8.75	\$733	\$880	N/A	\$404
Z3666EPTL	36 x 66 x 29-29.5	125	138.60	8.75	\$702	\$861	N/A	\$404
Z3660EPTL	36 x 60 x 29-29.5	100	129.15	6.50	\$677	\$824	N/A	\$336

Extended island worksurface on **left**. Connects to returns or bridges with a 16" throat on the right. **Not freestanding.** Grommet in worksurface. Shipped RTA (ready to assemble).

- Post is shipped in separate carton.

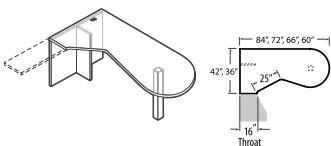

**Extended Corner "P" Island - RIGHT
Full End Panel & Post (T-Base)**

Z4284EPTR	42 x 84 x 29-29.5	100	178.50	10.75	\$863	\$1087	N/A	\$717
Z3684EPTR	36 x 84 x 29-29.5	100	153.30	9.50	\$795	\$994	N/A	\$538
Z3672EPTR	36 x 72 x 29-29.5	100	144.90	8.75	\$733	\$880	N/A	\$404
Z3666EPTR	36 x 66 x 29-29.5	125	138.60	8.75	\$702	\$861	N/A	\$404
Z3660EPTR	36 x 60 x 29-29.5	100	129.15	6.50	\$677	\$824	N/A	\$336

Extended island worksurface on **right**. Connects to returns or bridges with a 16" throat on the left. **Not freestanding.** Grommet in worksurface. Shipped RTA (ready to assemble).

- Post is shipped in separate carton.

EXTENDED CORNER ISLANDS (WITH FAUX MODESTY)

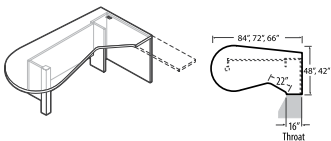

**Extended Corner "P" Island - LEFT
Faux Pedestal and Post**

Z4884EPFL	48 x 84 x 29-29.5	100	217	12	\$1087	\$1335	\$486	\$717
Z4872EPFL	48 x 72 x 29-29.5	100	194	10.50	\$1006	\$1223	\$401	\$538
Z4284EPFL	42 x 84 x 29-29.5	100	191	10.75	\$1020	\$1243	\$486	\$717
Z4272EPFL	42 x 72 x 29-29.5	100	172	8.75	\$947	\$1142	\$401	\$538
Z4266EPFL	42 x 66 x 29-29.5	100	160	8.75	\$909	\$1089	\$359	\$538

Extended island worksurface on **left**. Connects to returns or bridges with a 16" throat on the right. **Not freestanding.** Faux pedestal on the **right** is ideal for concealing a CPU. $\frac{3}{4}$ modesty panel is standard. Grommet in worksurface. Shipped RTA (ready to assemble) in 2 cartons.



Required Specifications

- Top finish
- Top/edge detail
- Base finish
- Monopost finish

Optional Specifications

- HP laminate
- Glazing - modesty panel
- Grommet position or power block cut-out

Accessories

- Power block
- Keyboard
- Pencil drawer

EXTENDED CORNER ISLANDS (WITH FAUX MODESTY)

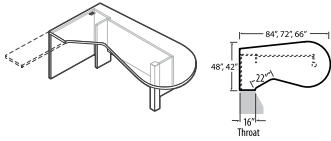

Extended Corner "P" Island - RIGHT Faux Pedestal and Post

MODEL#	DIMENSIONS	FREIGHT CLASS	WT/LBS.	CUBIC FT.	1" TOP	1.5" TOP	GLAZE ADD	HP ADD
D x W x H								
Z4884EPFR	48 x 84 x 29-29.5	100	217	12	\$1087	\$1335	\$486	\$717
Z4872EPFR	48 x 72 x 29-29.5	100	194	10.50	\$1006	\$1223	\$401	\$538
Z4284EPFR	42 x 84 x 29-29.5	100	191	10.75	\$1020	\$1243	\$486	\$717
Z4272EPFR	42 x 72 x 29-29.5	100	172	8.75	\$947	\$1142	\$401	\$538
Z4266EPFR	42 x 66 x 29-29.5	100	160	8.75	\$909	\$1089	\$359	\$538

Extended island worksurface on **left**. Connects to returns or bridges with a 16" throat on the right. **Not freestanding.** Faux pedestal on the **right** is ideal for concealing a CPU. ¾ modesty panel is standard. Grommet in worksurface. Shipped RTA (ready to assemble) in 2 cartons.

Laminate Modesty:



Glazed Modesty:



EXTENDED CORNER ISLANDS (WITH RECESSED MODESTY)

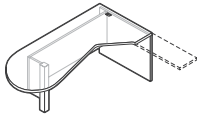

Extended Corner "P" Island - LEFT Recessed Modesty and Post

Z4284EPRL	42 x 84 x 29-29.5	100	199.50	21.50	\$961	\$1185	\$572	\$717
Z3684EPRL	36 x 84 x 29-29.5	100	173.25	19	\$871	\$1090	\$572	\$538
Z3672EPRL	36 x 72 x 29-29.5	100	156.45	17.50	\$801	\$969	\$521	\$404
Z3666EPRL	36 x 66 x 29-29.5	100	149.10	17.50	\$780	\$940	\$479	\$404
Z3660EPRL	36 x 60 x 29-29.5	92.5	140.70	13	\$746	\$893	\$437	\$336

Extended island worksurface on **left**. Connects to returns or bridges with a 16" throat on the right. **Not freestanding.** Grommet in worksurface. ¾ **recessed** modesty panel is standard. Shipped RTA (ready to assemble) in 2 cartons.

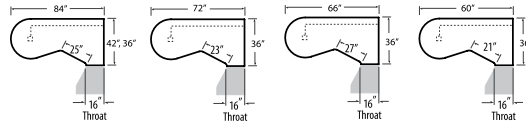

Laminate Modesty:

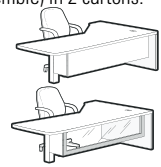

Glazed Modesty:

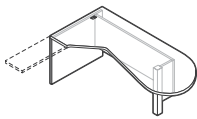

Extended Corner "P" Island - RIGHT Recessed Modesty and Post

Z4284EPRR	42 x 84 x 29-29.5	100	199.50	10.75	\$961	\$1185	\$572	\$717
Z3684EPRR	36 x 84 x 29-29.5	100	173.25	9.50	\$871	\$1090	\$572	\$538
Z3672EPRR	36 x 72 x 29-29.5	100	156.45	8.75	\$801	\$969	\$521	\$404
Z3666EPRR	36 x 66 x 29-29.5	100	149.10	8.75	\$780	\$940	\$479	\$404
Z3660EPRR	36 x 60 x 29-29.5	92.5	140.70	6.50	\$746	\$893	\$437	\$336

Extended island worksurface on **right**. Connects to returns or bridges with a 16" throat on the right. **Not freestanding.** Grommet in worksurface. ¾ **recessed** modesty panel is standard. Shipped RTA (ready to assemble) in 2 cartons.

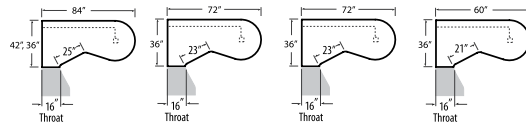

Laminate Modesty:

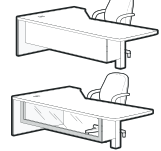

Glazed Modesty:

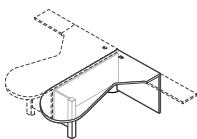

Extended Corner "P" Island - LEFT Flush Modesty and Post

Z4284EPML	42 x 84 x 29-29.5	100	200	10.75	\$972	\$1196	\$572	\$717
Z3684EPML	36 x 84 x 29-29.5	100	172	9.50	\$879	\$1078	\$572	\$538
Z3672EPML	36 x 72 x 29-29.5	100	156	8.75	\$807	\$974	\$521	\$404
Z3666EPML	36 x 66 x 29-29.5	100	150	8.75	\$775	\$914	\$479	\$404
Z3660EPML	36 x 60 x 29-29.5	92.5	141	6.50	\$752	\$898	\$437	\$336

Extended island worksurface on **left**. Connects to returns or bridges with a 16" throat on the right. **Not freestanding.** Grommet in worksurface. ¾ **flush** modesty panel is standard. Shipped RTA (ready to assemble) in 2 cartons.

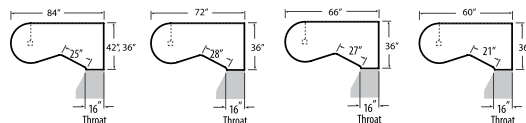

Laminate Modesty:

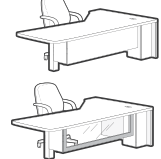

Glazed Modesty:

Required Specifications

- Top finish
- Top/edge detail
- Base finish
- Monopost finish

Optional Specifications

- HP laminate
- Glazing - modesty panel
- Grommet position or power block cut-out

Accessories

- Power block
- Keyboard
- Pencil drawer

EXTENDED CORNER ISLANDS (WITH RECESSED MODESTY)

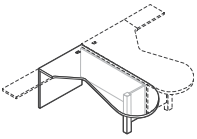

Extended Corner "P" Island - RIGHT
Flush Modesty and Post

MODEL#	DIMENSIONS D x W x H	FREIGHT CLASS	WT/LBS.	CUBIC FT.	1" TOP	1.5" TOP	GLAZE ADD	HP ADD
Z4284EPMR	42 x 84 x 29-29.5	100	200	10.75	\$972	\$1196	\$572	\$717
Z3684EPMR	36 x 84 x 29-29.5	100	172	9.50	\$879	\$1078	\$572	\$538
Z3672EPMR	36 x 72 x 29-29.5	100	156	8.75	\$807	\$974	\$521	\$404
Z3666EPMR	36 x 66 x 29-29.5	100	150	8.75	\$775	\$914	\$479	\$404
Z3660EPMR	36 x 60 x 29-29.5	92.5	141	6.50	\$752	\$898	\$437	\$336

Extended island worksurface on **left**. Connects to returns or bridges with a 16" throat on the right. **Not freestanding.** Grommet in worksurface. $\frac{3}{4}$ " flush modesty panel is standard. Shipped RTA (ready to assemble) in 2 cartons.

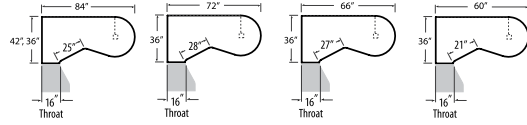

Laminate Modesty:

Glazed Modesty:

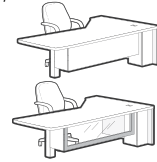

"D" ISLANDS

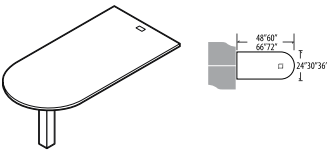

"D" Island with Monopost

Z3672I	36 x 72 x 29-29.5	100	144	8.50	\$557	\$707	N/A	\$387
Z3066I	29.63 x 66 x 29-29.5	125	97	7.50	\$519	\$637	N/A	\$362
Z3060I	29.63 x 60 x 29-29.5	85	88	6.76	\$519	\$631	N/A	\$336
Z2466I	24 x 66 x 29-29.5	150	84	7.50	\$474	\$577	N/A	\$269
Z2460I	24 x 60 x 29-29.5	150	72	6.76	\$449	\$542	N/A	\$248
Z2448I	24 x 48 x 29-29.5	150	63	5.76	\$416	\$497	N/A	\$197

Attaches to edge of worksurfaces. Attaching hardware included. Grommet in worksurface. Shipped RTA (ready to assemble).

- Post is shipped in separate carton.

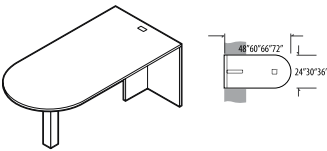

"D" Island - Full End Panel and
Monopost (T-Base)

Z3672FI	36 x 72 x 29-29.5	100	157	8.50	\$684	\$834	N/A	\$387
Z3072FI	29.63 x 72 x 29-29.5	100	135	7.50	\$684	\$808	N/A	\$363
Z3066FI	29.63 x 66 x 29-29.5	100	128	7.50	\$621	\$739	N/A	\$362
Z3060FI	29.63 x 60 x 29-29.5	125	108	7.50	\$583	\$695	N/A	\$336
Z2466FI	24 x 66 x 29-29.5	125	111	7.50	\$576	\$681	N/A	\$269
Z2460FI	24 x 60 x 29-29.5	125	103	6.76	\$551	\$645	N/A	\$248
Z2448FI	24 x 48 x 29-29.5	125	90	5.76	\$519	\$599	N/A	\$197

Attaches to edge of worksurfaces. Attaching hardware included. Grommet in worksurface. **Not freestanding.** Shipped RTA (ready to assemble).

- Post is shipped in separate carton.

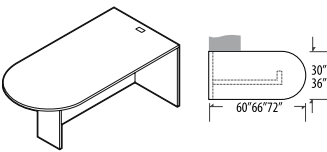

"D" Island LEFT - Full Modesty Panel
(H-Base)

Z3672FIL	36 x 72 x 29-29.5	65	171	7	\$646	\$796	N/A	\$387
Z3066FIL	29.63 x 66 x 29-29.5	65	140	6	\$576	\$737	N/A	\$362
Z3060FIL	29.63 x 60 x 29-29.5	65	128	5.25	\$525	\$637	N/A	\$336

Connects to the left side of a worksurface. Attaching hardware included. Accommodates all 19" pedestals (mobile and hanging pedestals and 19.3" deep storage shells). Grommet in worksurface. Shipped RTA (ready to assemble).

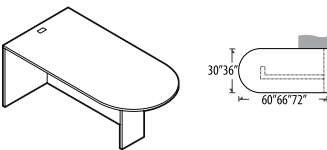

"D" Island RIGHT - Full Modesty Panel
(H-Base)

Z3672FIR	36 x 72 x 29-29.5	65	171	7	\$646	\$796	N/A	\$387
Z3066FIR	29.63 x 66 x 29-29.5	65	140	6	\$576	\$737	N/A	\$362
Z3060FIR	29.63 x 60 x 29-29.5	65	128	5.25	\$525	\$637	N/A	\$336

Connects to the right side of a worksurface. Attaching hardware included. Accommodates all 19" pedestals (mobile and hanging pedestals and 19.3" deep storage shells). Grommet in worksurface. Shipped RTA (ready to assemble).

Required Specifications

- Top finish
- Top/edge detail
- Base finish
- Monopost finish

Optional Specifications

- HP laminate
- Glazing - modesty panel
- Grommet position or power block cut-out

Accessories

- Power block
- Keyboard
- Pencil drawer

"D" ISLANDS

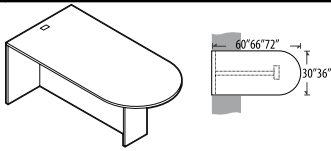

"D" Island CENTER - Full Modesty Panel (H-Base)

MODEL#	DIMENSIONS	FREIGHT CLASS	WT/LBS.	CUBIC FT.	1" TOP	1.5" TOP	GLAZE ADD	HP ADD
D x W x H								
Z3672FIC	36 x 72 x 29-29.5	65	171	7	\$646	\$796	N/A	\$387
Z3066FIC	29.63 x 66 x 29-29.5	65	140	6	\$576	\$737	N/A	\$362
Z3060FIC	29.63 x 60 x 29-29.5	65	123	5.25	\$525	\$637	N/A	\$336

Connects in between two worksurfaces. Attaching hardware included. **Will not accommodate pedestals.** Grommet in worksurface. Shipped RTA (ready to assemble).

"P" ISLANDS

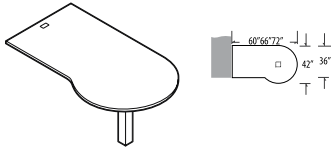

"P" Island LEFT with Post

Z3672IPL	42 x 72 x 29-29.5	125	128	18.52	\$634	\$787	N/A	\$516
Z3666IPL	42 x 66 x 29-29.5	125	119	17.52	\$634	\$752	N/A	\$516
Z3660IPL	42 x 60 x 29-29.5	125	110	16	\$576	\$694	N/A	\$439

Attaches to edge of worksurfaces. Attaching hardware included. Grommet in worksurface. Shipped RTA (ready to assemble).
 • Post is shipped in separate carton.

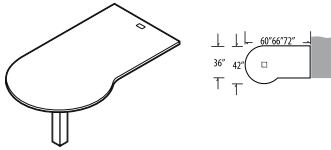

"P" Island RIGHT with Post

Z3672IPR	42 x 72 x 29-29.5	125	128	18.52	\$634	\$787	N/A	\$516
Z3666IPR	42 x 66 x 29-29.5	125	119	17.52	\$634	\$752	N/A	\$516
Z3660IPR	42 x 60 x 29-29.5	125	110	16	\$576	\$694	N/A	\$439

Attaches to edge of worksurfaces. Attaching hardware included. Grommet in worksurface. Shipped RTA (ready to assemble).
 • Post is shipped in separate carton.

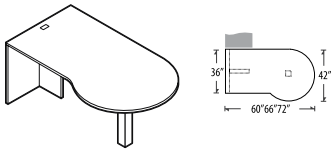

"P" Island LEFT - Full End Panel and Post (T-Base)

Z3672FPL	42 x 72 x 29-29.5	100	163	18.52	\$762	\$915	N/A	\$516
Z3666FPL	42 x 66 x 29-29.5	100	155	17.52	\$762	\$886	N/A	\$516
Z3660FPL	42 x 60 x 29-29.5	100	145	16	\$704	\$822	N/A	\$439

Connects to left side of worksurface. Attaching hardware included. **Not freestanding.** Grommet in worksurface. Shipped RTA (ready to assemble).
 • Post is shipped in separate carton.

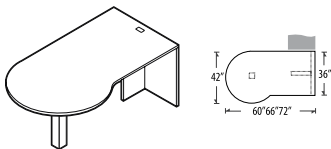

"P" Island RIGHT - Full End Panel and Post (T-Base)

Z3672FPR	42 x 72 x 29-29.5	100	163	18.52	\$762	\$915	N/A	\$516
Z3666FPR	42 x 66 x 29-29.5	100	155	17.52	\$762	\$886	N/A	\$516
Z3660FPR	42 x 60 x 29-29.5	100	145	16	\$704	\$822	N/A	\$439

Connects to right side of worksurface. Attaching hardware included. **Not freestanding.** Grommet in worksurface. Shipped RTA (ready to assemble).
 • Post is shipped in separate carton.

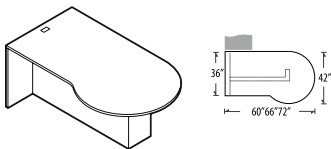

"P" Island LEFT - Full Modesty Panel (H-Base)

Z3672PL	42 x 72 x 29-29.5	65	178	7.75	\$717	\$869	N/A	\$516
Z3666PL	42 x 66 x 29-29.5	65	167	7.25	\$654	\$772	N/A	\$516
Z3660PL	42 x 60 x 29-29.5	65	155	6.50	\$601	\$720	N/A	\$439

Connects to the left side of a worksurface. Attaching hardware included. Accommodates all 19" pedestals (freestanding, mobile and hanging pedestals). Grommet in worksurface. Shipped RTA (ready to assemble).

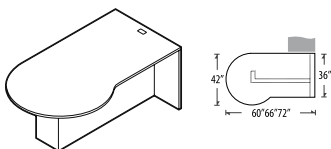

"P" Island RIGHT - Full Modesty Panel (H-Base)

Z3672PR	42 x 72 x 29-29.5	65	178	7.75	\$717	\$869	N/A	\$516
Z3666PR	42 x 66 x 29-29.5	65	167	7.25	\$654	\$772	N/A	\$516
Z3660PR	42 x 60 x 29-29.5	65	155	6.50	\$601	\$720	N/A	\$439

Connects to the left side of a worksurface. Attaching hardware included. Accommodates all 19" pedestals (freestanding, mobile and hanging pedestals). Grommet in worksurface. Shipped RTA (ready to assemble).

Required Specifications

Top finish
 Top/edge detail
 Base finish
 Monopost finish

Optional Specifications

HP laminate
 Grommet position or power block cut-out

Accessories

Power block
 Keyboard
 Pencil drawer

RECTANGULAR ISLANDS

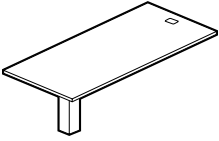

Rectangular Island w/Monopost

MODEL#	DIMENSIONS D x W x H	FREIGHT CLASS	WT./LBS.	CUBIC FT.	1" TOP	1.5" TOP	GLAZE ADD	HP ADD
Z3672RI	36 x 72 x 29-29.5	85	90	7.25	\$551	\$700	N/A	\$440
Z3066RI	30 x 66 x 29-29.5	92.5	72	6.25	\$514	\$630	N/A	\$362
Z3060RI	30 x 60 x 29-29.5	85	66	5.25	\$514	\$625	N/A	\$338
Z2466RI	24 x 66 x 29-29.5	100	63	7.50	\$468	\$575	N/A	\$269
Z2460RI	24 x 60 x 29-29.5	100	57	6.50	\$445	\$538	N/A	\$250
Z2448RI	24 x 48 x 29-29.5	100	47	5.75	\$413	\$496	N/A	\$200

Attaches to edge of worksurfaces. Attaching hardware included. Grommet in worksurface. Shipped RTA (ready to assemble).

Not freestanding.

- Post is shipped in separate carton.

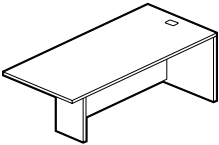

Rectangular Island LEFT - Full Modesty Panel (H-Base)

Z3672RFIL	36 x 72 x 29-29.5	70	145	7.25	\$639	\$788	N/A	\$440
Z3084RFIL	30 x 84 x 29-29.5	70	146	7.25	\$635	\$783	N/A	\$436
Z3066RFIL	30 x 66 x 29-29.5	70	121	6.25	\$570	\$732	N/A	\$362
Z3060RFIL	30 x 60 x 29-29.5	70	110	5.25	\$519	\$630	N/A	\$338
Z2472RFIL	24 x 72 x 29-29.5	70	116	6.25	\$487	\$602	N/A	\$274
Z2466RFIL	24 x 66 x 29-29.5	70	109	5.75	\$463	\$579	N/A	\$269
Z2460RFIL	24 x 60 x 29-29.5	70	99	5.25	\$440	\$533	N/A	\$250
Z2448RFIL	24 x 48 x 29-29.5	70	85	4.20	\$417	\$487	N/A	\$200

Connects to the **left** side of a worksurface. Attaching hardware included. 36" and 30"D accommodates all 19" pedestals (freestanding, mobile and hanging pedestals). Grommet in worksurface. Shipped RTA (ready to assemble). **Not freestanding.**

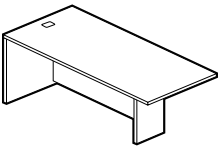

Rectangular Island RIGHT - Full Modesty Panel (H-Base)

Z3672RFIR	36 x 72 x 29-29.5	70	145	7.25	\$639	\$788	N/A	\$440
Z3084RFIR	30 x 84 x 29-29.5	70	146	7.25	\$635	\$783	N/A	\$436
Z3066RFIR	30 x 66 x 29-29.5	70	121	6.25	\$570	\$732	N/A	\$362
Z3060RFIR	30 x 60 x 29-29.5	70	110	5.25	\$519	\$630	N/A	\$338
Z2472RFIR	24 x 72 x 29-29.5	70	116	6.25	\$487	\$602	N/A	\$274
Z2466RFIR	24 x 66 x 29-29.5	70	109	5.75	\$463	\$579	N/A	\$269
Z2460RFIR	24 x 60 x 29-29.5	70	99	5.25	\$440	\$533	N/A	\$250
Z2448RFIR	24 x 48 x 29-29.5	70	85	4.20	\$417	\$487	N/A	\$200

Connects to the **right** side of a worksurface. Attaching hardware included. 36" and 30"D accommodates all 19" pedestals (freestanding, mobile and hanging pedestals). Grommet in worksurface. Shipped RTA (ready to assemble). **Not freestanding.**

RADIUS SPANNER ISLANDS

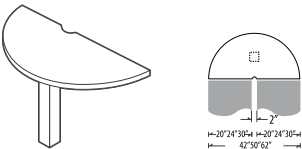

Radius Spanner Island with 2" Panel Cut-Out

Z62RS	30.57 x 62 x 29-29.5	150	79	6.76	\$678	\$806	N/A	\$310
Z50RS	25 x 50 x 29-29.5	150	60	5.76	\$583	\$679	N/A	\$258
Z42RS	25 x 42 x 29-29.5	150	53	5.26	\$532	\$628	N/A	\$207

Used to connect two back-to-back units of same depth with a panel. Includes monopost. Requires "L" bracket (model **MLB90**) for connection to full end panels. Shipped RTA (ready to assemble).

- Post is shipped in separate carton.
- **MLB90** must be ordered separately - see page 283.

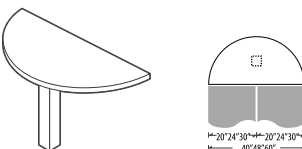

Radius Spanner Island

Z60RS	29.69 x 60 x 29-29.5	125	76	5.76	\$678	\$794	N/A	\$258
Z48RS	24 x 48 x 29-29.5	150	56	5.76	\$583	\$666	N/A	\$207
Z40RS	24 x 40 x 29-29.5	150	51	5.26	\$532	\$615	N/A	\$207

Used to connect two back-to-back units of same depth with a panel. Includes monopost. Requires "L" bracket (model **MLB90**) for connection to full end panels. Shipped RTA (ready to assemble).

- Post is shipped in separate carton.
- **MLB90** must be ordered separately - see page 283.

Required Specifications

Top finish
Top/edge detail
Base finish
Monopost finish

Optional Specifications

HP laminate
Grommet position or power block cut-out

Accessories

Power block
Keyboard
Pencil drawer

PEDESTALS



Mobile Pedestal with Overhang*



Mobile Pedestal*



Mobile Pedestal with Overhang*



Mobile Pedestal*

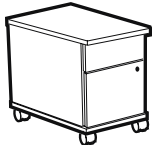

Mobile Pedestal with Overhang*

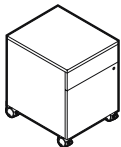

Mobile Pedestal*

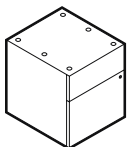

Hanging Pedestal

MODEL#	DIMENSIONS D x W x H	FREIGHT CLASS	WT/LBS.	CUBIC FT.	1" TOP	1.5" TOP	GLAZE ADD	HP ADD
ZMPFF28	29 x 16 x 28	92.5	106	10.25	\$909	N/A	N/A	\$156
ZMPFF22	23 x 16 x 28	92.5	95	8.25	\$865	N/A	N/A	\$156

File/File drawers on fully progressive ball bearing slides, accommodate letter and legal size hanging files. Pedestal top features 1" overhang with built-in grip for ease of mobility. Includes counterweight to prevent tipping. Drawers are locking. Only front casters are locking.

ZMPFF19	19 x 16 x 28	85	97	7.25	\$817	N/A	N/A	\$156
---------	--------------	----	----	------	--------------	-----	-----	--------------

File/File drawers on fully progressive ball bearing slides, accommodate letter and legal size hanging files. Drawers are locking. Only front casters are locking.

ZMPBBF28	29 x 16 x 28	92.5	105	10.25	\$834	N/A	N/A	\$156
ZMPBBF22	23 x 16 x 28	92.5	92	8.25	\$803	N/A	xxx	\$154

Box/Box/File drawers on fully progressive ball bearing slides, accommodate letter and legal size hanging files. Pedestal top features 1" overhang with built-in grip for ease of mobility. Includes counterweight to prevent tipping. File drawer and lower box drawer are locking. Only front casters are locking.

ZMPBBF19	19 x 16 x 28	85	96	7.25	\$761	N/A	N/A	\$156
----------	--------------	----	----	------	--------------	-----	-----	--------------

Box/Box/File drawers on fully progressive ball bearing slides, accommodate letter and legal size hanging files. File drawer and lower box drawer are locking. Only front casters are locking.

ZMPBF28	29 x 16 x 22	92.5	83	8.25	\$733	N/A	N/A	\$156
ZMPBF22	23 x 16 x 22	92.5	73	6.75	\$714	N/A	N/A	\$156

Box/File drawers on fully progressive ball bearing slides, accommodate letter and legal size hanging files. Pedestal top features 1" overhang with built-in grip for ease of mobility. Includes counterweight to prevent tipping. Drawers are locking. Only front casters are locking.

ZMPBF19	19 x 16 x 22	85	77	6.25	\$670	N/A	N/A	\$156
---------	--------------	----	----	------	--------------	-----	-----	--------------

Box/File drawers on fully progressive ball bearing slides, accommodate letter and legal size hanging files. Drawers are locking. Only front casters are locking.

ZHPBF18	19 x 16 x 18	92.5	48	4.50	\$499	N/A	N/A	N/A
---------	--------------	------	----	------	--------------	-----	-----	-----

Box/File drawers on fully progressive ball bearing slides, accommodate letter and legal size hanging files. Drawers are locking.

Required Specifications

- Top finish*
- Top/edge detail*
- Lock finish
- Base finish

Optional Specifications

- Handles
- HP laminate (*Not available on ZHPBF18*)
- Key #

STORAGE SHELLS - 28" HIGH

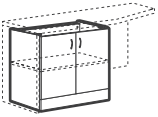

Storage Shell*



Glazed door option

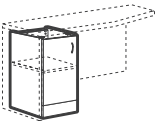

Storage Shell - LEFT*

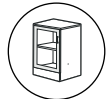

Glazed door option

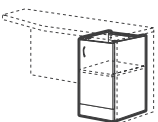

Storage Shell - RIGHT*

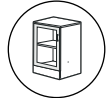

Glazed door option

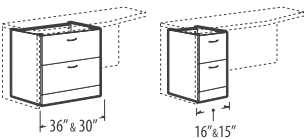

File/File Shell

MODEL#	DIMENSIONS D x W x H	FREIGHT CLASS	WT/LBS.	CUBIC FT.	1" TOP	1.5" TOP	GLAZE ADD	HP ADD
Z36L2SHS	23.4 x 36 x 27.5-28	150	100	18.50	\$691	N/A	\$538	N/A
Z30L2SHS	23.4 x 30 x 27.5-28	150	88	15.50	\$616	N/A	\$494	N/A
Z36M2SHS	19.3 x 36 x 27.5-28	150	89	15.50	\$605	N/A	\$538	N/A
Z30M2SHS	19.3 x 30 x 27.5-28	150	78	13.25	\$549	N/A	\$494	N/A

For use under 29" H returns, extended corners, freestanding and connectable tables of the same depth. **No top or back. One adjustable shelf.** Standard with lock.

Z21L2SHSL	23.4 x 21 x 27.5-28	125	70	11	\$476	N/A	\$304	N/A
Z18L2SHSL	23.4 x 18 x 27.5-28	125	64	9.75	\$456	N/A	\$277	N/A
Z16L2SHSL	23.4 x 16 x 27.5-28	125	60	9	\$428	N/A	\$271	N/A
Z15L2SHSL	23.4 x 15 x 27.5-28	125	59	8.25	\$414	N/A	\$244	N/A
Z12L2SHSL	23.4 x 12 x 27.5-28	125	53	6.75	\$387	N/A	\$221	N/A
Z21M2SHSL	19.3 x 21 x 27.5-28	125	61	9.50	\$407	N/A	\$304	N/A
Z18M2SHSL	19.3 x 18 x 27.5-28	125	56	8.25	\$389	N/A	\$277	N/A
Z16M2SHSL	19.3 x 16 x 27.5-28	125	52	7	\$368	N/A	\$271	N/A
Z15M2SHSL	19.3 x 15 x 27.5-28	125	52	6.75	\$349	N/A	\$244	N/A
Z12M2SHSL	19.3 x 12 x 27.5-28	100	47	5.75	\$327	N/A	\$221	N/A

For use under 29" H returns, extended corners, freestanding and connectable tables of the same depth. **No top or back. One adjustable shelf.** Standard with lock.

Z21L2SHSR	23.4 x 21 x 27.5-28	125	70	11	\$476	N/A	\$304	N/A
Z18L2SHSR	23.4 x 18 x 27.5-28	125	64	9.75	\$456	N/A	\$277	N/A
Z16L2SHSR	23.4 x 16 x 27.5-28	125	60	9	\$428	N/A	\$271	N/A
Z15L2SHSR	23.4 x 15 x 27.5-28	125	59	8.25	\$414	N/A	\$244	N/A
Z12L2SHSR	23.4 x 12 x 27.5-28	125	53	6.75	\$387	N/A	\$221	N/A
Z21M2SHSR	19.3 x 21 x 27.5-28	125	61	9.50	\$407	N/A	\$304	N/A
Z18M2SHSR	19.3 x 18 x 27.5-28	125	56	8.25	\$389	N/A	\$277	N/A
Z16M2SHSR	19.3 x 16 x 27.5-28	125	52	7	\$368	N/A	\$271	N/A
Z15M2SHSR	19.3 x 15 x 27.5-28	125	52	6.75	\$349	N/A	\$244	N/A
Z12M2SHSR	19.3 x 12 x 27.5-28	100	47	5.75	\$327	N/A	\$221	N/A

For use under 29" H returns, extended corners, freestanding and connectable tables of the same depth. **No top or back. One adjustable shelf.** Standard with lock.

Z36L2ES	23.4 x 36 x 27.5-28	125	121	18.50	\$1040	N/A	N/A	N/A
Z30L2ES	23.4 x 30 x 27.5-28	125	110	15.50	\$954	N/A	N/A	N/A
Z16L2ES	23.4 x 16 x 27.5-28	100	75	9	\$573	N/A	N/A	N/A
Z15L2ES	23.4 x 15 x 27.5-28	100	75	8.25	\$559	N/A	N/A	N/A
Z36M2ES	19.3 x 36 x 27.5-28	125	114	15.50	\$958	N/A	N/A	N/A
Z30M2ES	19.3 x 30 x 27.5-28	125	102	13.25	\$895	N/A	N/A	N/A
Z16M2ES	19.3 x 16 x 27.5-28	100	69	7	\$524	N/A	N/A	N/A
Z15M2ES	19.3 x 15 x 27.5-28	92.5	68	6.75	\$511	N/A	N/A	N/A

For use under 29" H returns, extended corners, freestanding and connectable tables of the same depth. **No top or back. Two file drawers.** Lock secures all drawers. 36" and 30" wide models have front-to-back and side-to-side letter/legal filing capability. Side-to-side file bars included.

- 15" wide models have only side-to-side filing capability
- Lateral file drawer construction is for accommodating hanging files NOT for stacking materials on the drawer bottom.

Required Specifications

Base finish
Handles*

Optional Specifications

Handles
Glazed doors - storage shell doors
Key #

STORAGE SHELLS - 28" HIGH

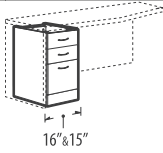

Box/Box/File Shell

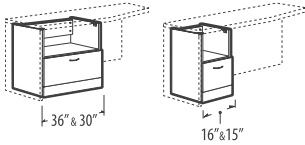

File Shell with Open Shelf

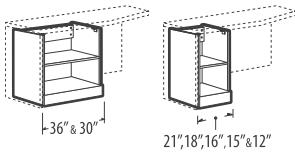

Open Shelving Shell

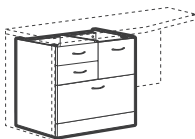

Mixed Storage Shell - LEFT

MODEL#	DIMENSIONS D x W x H	FREIGHT CLASS	WT/LBS.	CUBIC FT.	1" TOP	1.5" TOP	GLAZE ADD	HP ADD
Z16L2BFS	23.4 x 16 x 27.5-28	100	77	9	\$661	N/A	N/A	N/A
Z15L2BFS	23.4 x 15 x 27.5-28	100	77	8.25	\$647	N/A	N/A	N/A
Z16M2BFS	19.3 x 16 x 27.5-28	92.5	71	7	\$599	N/A	N/A	N/A
Z15M2BFS	19.3 x 15 x 27.5-28	92.5	71	6.75	\$587	N/A	N/A	N/A

For use **under 29"H** returns, extended corners, freestanding and connectable tables of the same depth. **No top or back. Two box and one file drawer.** One pencil tray. Lock secures all drawers.

- 15" wide models have only side-to-side filing capability

Z36L2FS	23.4 x 36 x 27.5-28	150	109	18.50	\$809	N/A	N/A	N/A
Z30L2FS	23.4 x 30 x 27.5-28	125	98	15.50	\$727	N/A	N/A	N/A
Z16L2FS	23.4 x 16 x 27.5-28	125	68	9	\$483	N/A	N/A	N/A
Z15L2FS	23.4 x 15 x 27.5-28	100	67	8.25	\$477	N/A	N/A	N/A
Z36M2FS	19.3 x 36 x 27.5-28	125	99	15.50	\$719	N/A	N/A	N/A
Z30M2FS	19.3 x 30 x 27.5-28	125	89	13.25	\$662	N/A	N/A	N/A
Z16M2FS	19.3 x 16 x 27.5-28	100	59	7	\$406	N/A	N/A	N/A
Z15M2FS	19.3 x 15 x 27.5-28	100	57	6.75	\$398	N/A	N/A	N/A

For use **under 29"H** returns, extended corners, freestanding and connectable tables of the same depth. **No top or back. One file drawer.** Lock secures file drawer. 36" and 30" wide models have front-to-back and side-to-side letter/legal filing capability. Side-to-side file bars included.

- 15" wide models have only side-to-side filing capability
- Lateral file drawer construction is for accommodating hanging files NOT for stacking materials on the drawer bottom.

Z36L2SHSN	23.4 x 36 x 27.5-28	150	84.03	18.50	\$494	N/A	N/A	N/A
Z30L2SHSN	23.4 x 30 x 27.5-28	150	74.69	15.50	\$437	N/A	N/A	N/A
Z21L2SHSN	23.4 x 21 x 27.5-28	150	60.69	11	\$367	N/A	N/A	N/A
Z18L2SHSN	23.4 x 18 x 27.5-28	150	56.02	9.75	\$355	N/A	N/A	N/A
Z16L2SHSN	23.4 x 16 x 27.5-28	150	52.90	9	\$329	N/A	N/A	N/A
Z15L2SHSN	23.4 x 15 x 27.5-28	125	52.35	8.25	\$322	N/A	N/A	N/A
Z12L2SHSN	23.4 x 12 x 27.5-28	125	47.68	6.75	\$301	N/A	N/A	N/A
Z36M2SHSN	19.3 x 36 x 27.5-28	150	73.03	15.50	\$409	N/A	N/A	N/A
Z30M2SHSN	19.3 x 30 x 27.5-28	150	64.69	13.25	\$371	N/A	N/A	N/A
Z21M2SHSN	19.3 x 21 x 27.5-28	150	51.69	9.50	\$298	N/A	N/A	N/A
Z18M2SHSN	19.3 x 18 x 27.5-28	150	48.02	8.25	\$287	N/A	N/A	N/A
Z16M2SHSN	19.3 x 16 x 27.5-28	125	44.90	7	\$268	N/A	N/A	N/A
Z15M2SHSN	19.3 x 15 x 27.5-28	125	45.35	6.75	\$258	N/A	N/A	N/A
Z12M2SHSN	19.3 x 12 x 27.5-28	125	41.68	5.75	\$241	N/A	N/A	N/A

For use **under 29"H** returns, extended corners, freestanding and connectable tables of the same depth. **No top or back. One adjustable shelf.**

Z36L2XSL	23.4 x 36 x 27.5-28	100	152	18.50	\$1253	N/A	N/A	N/A
Z30L2XSL	23.4 x 30 x 27.5-28	100	136	15.50	\$1147	N/A	N/A	N/A
Z36M2XSL	19.3 x 36 x 27.5-28	100	139	15.50	\$1181	N/A	N/A	N/A
Z30M2XSL	19.3 x 30 x 27.5-28	100	124	13.25	\$1098	N/A	N/A	N/A

For use **under 29"H** returns, extended corners, freestanding and connectable tables of the same depth. **No top or back.** Two box drawers on **left**, one file drawer on **right** and one lateral file drawer on bottom. Right lock secures one file drawer, the left lock secures two box and the lateral file. One pencil tray. Front-to-back and side-to-side letter/legal filing capability. Side-to-side file bars included.

- Lateral file drawer construction is for accommodating hanging files NOT for stacking materials on the drawer bottom.

Required Specifications

Base finish
Handles

Optional Specifications

Box Drawer Option (no upcharge - *not available on Open Shelving Shell*)
Key #

STORAGE SHELLS - 28" HIGH

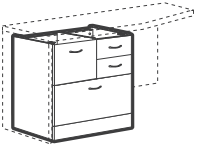

Mixed Storage Shell - RIGHT**

MODEL#	DIMENSIONS D x W x H	FREIGHT CLASS	WT/LBS.	CUBIC FT.	1" TOP	1.5" TOP	GLAZE ADD	HP ADD
Z36L2XSR	23.4 x 36 x 27.5-28	100	152	18.50	\$1253	N/A	N/A	N/A
Z30L2XSR	23.4 x 30 x 27.5-28	100	136	15.50	\$1147	N/A	N/A	N/A
Z36M2XSR	19.3 x 36 x 27.5-28	100	139	15.50	\$1181	N/A	N/A	N/A
Z30M2XSR	19.3 x 30 x 27.5-28	100	124	13.25	\$1098	N/A	N/A	N/A

For use **under 29" H** returns, extended corners, freestanding and connectable tables of the same depth. **No top or back.** Two box drawers on **right**, one file drawer on **right** and one lateral file drawer on bottom. Right lock secures two box and lateral file, the left lock secures one file drawer. One pencil tray. Front-to-back and side-to-side letter/legal filing capability. Side-to-side file bars included.

- Lateral file drawer construction is for accommodating hanging files **NOT** for stacking materials on the drawer bottom.

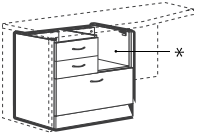

Mixed Storage Shell with Open Shelf - LEFT**



* Accepts collator

Z36L2XNSL	23.4 x 36 x 27.5-28	125	133	18.50	\$1059	N/A	N/A	N/A
Z30L2XNSL	23.4 x 30 x 27.5-28	125	121	15.50	\$964	N/A	N/A	N/A
Z36M2XNSL	19.3 x 36 x 27.5-28	125	121	15.50	\$986	N/A	N/A	N/A
Z30M2XNSL	19.3 x 30 x 27.5-28	100	109	13.25	\$918	N/A	N/A	N/A

For use **under 29" H** returns, extended corners, freestanding and connectable tables of the same depth. **No top or back.** Two box drawers on **left**, one open shelf on **right** and one lateral file drawer on bottom. Lock secures all drawers. One pencil tray. Front-to-back and side-to-side letter/legal filing capability. Side-to-side file bars included.

- Lateral file drawer construction is for accommodating hanging files **NOT** for stacking materials on the drawer bottom.

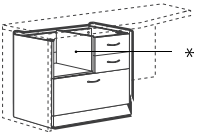

Mixed Storage Shell with Open Shelf - RIGHT**



* Accepts collator

Z36L2XNSR	23.4 x 36 x 27.5-28	125	133	18.50	\$1059	N/A	N/A	N/A
Z30L2XNSR	23.4 x 30 x 27.5-28	125	121	15.50	\$964	N/A	N/A	N/A
Z36M2XNSR	19.3 x 36 x 27.5-28	125	121	15.50	\$986	N/A	N/A	N/A
Z30M2XNSR	19.3 x 30 x 27.5-28	100	109	13.25	\$918	N/A	N/A	N/A

For use **under 29" H** returns, extended corners, freestanding and connectable tables of the same depth. **No top or back.** Two box drawers on **right**, one open shelf on **left** and one lateral file drawer on bottom. Lock secures all drawers. One pencil tray. Front-to-back and side-to-side letter/legal filing capability. Side-to-side file bars included.

- Lateral file drawer construction is for accommodating hanging files **NOT** for stacking materials on the drawer bottom.

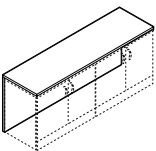

Credenza Top and Back*

Z2072TB	20 x 72 x 29.5-30	70	106	6	\$463	\$556	N/A	\$269
Z2066TB	20 x 66 x 29-29.5	70	106	6	\$454	\$532	N/A	\$269
Z2060TB	20 x 60 x 29.5-30	70	106	6	\$398	\$481	N/A	\$224
Z2472TB	24 x 72 x 29.5-30	70	117	5.90	\$481	\$593	N/A	\$269
Z2466TB	24 x 66 x 28-28.5	70	117	5.90	\$463	\$565	N/A	\$269
Z2460TB	24 x 60 x 29.5-30	70	117	5.90	\$421	\$514	N/A	\$224

For use with the following: Storage Shells, File Shells w/Open Shelf, Open Shelving Shells, and Mixed Storage Shells. Shipped RTA (ready to assemble).

STORAGE MODULES - 29" / 29.5" HIGH

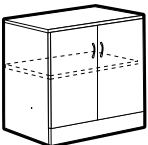

Storage Cabinet with Doors*



Glazed door option

Z36L2SH	24 x 36 x 29-29.5	125	142.80	18.50	\$924	\$978	\$538	\$135
Z30L2SH	24 x 30 x 29-29.5	125	123.90	15.50	\$831	\$876	\$494	\$113
Z36M2SH	20 x 36 x 29-29.5	100	126	15.50	\$847	\$894	\$538	\$135
Z30M2SH	20 x 30 x 29-29.5	100	109.20	13.25	\$768	\$806	\$494	\$113
Z36S2SH	16 x 36 x 29-29.5	100	110.25	12.50	\$782	\$827	\$538	\$101
Z30S2SH	16 x 30 x 29-29.5	100	93.45	10.50	\$689	\$720	\$494	\$91

Laminate doors are standard. **Includes one adjustable shelf.** Standard with lock

Required Specifications

- Top finish*
- Handles
- Top/edge detail*
- Base finish**

Optional Specifications

- Box drawer - no upcharge**
- HP laminate*
- Collator (open shelves)
- Glazed doors (Z3xx2SH)

STORAGE MODULES - 29" / 29.5" HIGH

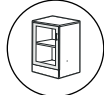
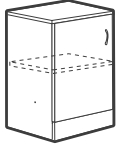

Glazed door option

Storage Cabinet with Door - LEFT*

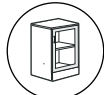
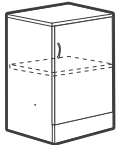

Glazed door option

Storage Cabinet with Door - RIGHT*



21", 18", 16", 15" & 12"

Open Storage Cabinet

MODEL#	DIMENSIONS	FREIGHT CLASS	WT/LBS.	CUBIC FT.	1" TOP	1.5" TOP	GLAZE ADD	HP ADD
D x W x H								
Z21L2SHL	24 x 21 x 29-29.5	100	94.50	11	\$677	\$713	\$304	\$91
Z18L2SHL	24 x 18 x 29-29.5	100	85.05	9.75	\$638	\$670	\$277	\$68
Z16L2SHL	24 x 16 x 29-29.5	100	79.80	9	\$612	\$643	\$271	\$52
Z15L2SHL	24 x 15 x 29-29.5	100	76.65	8.25	\$566	\$592	\$244	\$52
Z12L2SHL	24 x 12 x 29-29.5	92.5	68.25	6.75	\$535	\$556	\$221	\$46
Z21M2SHL	20 x 21 x 29-29.5	100	84	9.50	\$600	\$632	\$304	\$68
Z18M2SHL	20 x 18 x 29-29.5	100	75.60	8.25	\$567	\$595	\$277	\$68
Z16M2SHL	20 x 16 x 29-29.5	100	69.30	7	\$538	\$565	\$271	\$52
Z15M2SHL	20 x 15 x 29-29.5	100	66.15	6.75	\$513	\$536	\$244	\$46
Z12M2SHL	20 x 12 x 29-29.5	92.5	60	5.75	\$477	\$495	\$221	\$46
Z21S2SHL	16 x 21 x 29-29.5	100	71.40	7.50	\$549	\$574	\$304	\$46
Z18S2SHL	16 x 18 x 29-29.5	100	64.05	6.75	\$525	\$551	\$277	\$46
Z16S2SHL	16 x 16 x 29-29.5	100	58.80	6	\$501	\$527	\$271	\$46
Z15S2SHL	16 x 15 x 29-29.5	100	56.70	5.75	\$473	\$494	\$244	\$46
Z12S2SHL	16 x 12 x 29-29.5	92.5	50.40	4.75	\$440	\$458	\$221	\$46

Laminate doors are standard. Includes one adjustable shelf. Standard with lock

Z21L2SHR	24 x 21 x 29-29.5	100	94.50	11	\$677	\$713	\$304	\$91
Z18L2SHR	24 x 18 x 29-29.5	100	85.05	9.75	\$638	\$670	\$277	\$68
Z16L2SHR	24 x 16 x 29-29.5	100	79.80	9	\$612	\$643	\$271	\$52
Z15L2SHR	24 x 15 x 29-29.5	100	76.65	8.25	\$566	\$592	\$244	\$52
Z12L2SHR	24 x 12 x 29-29.5	92.5	68.25	6.75	\$535	\$556	\$221	\$46
Z21M2SHR	20 x 21 x 29-29.5	100	84	9.50	\$600	\$632	\$304	\$68
Z18M2SHR	20 x 18 x 29-29.5	100	75.60	8.25	\$567	\$595	\$277	\$68
Z16M2SHR	20 x 16 x 29-29.5	100	69.30	7	\$538	\$565	\$271	\$52
Z15M2SHR	20 x 15 x 29-29.5	100	66.15	6.75	\$513	\$536	\$244	\$46
Z12M2SHR	20 x 12 x 29-29.5	92.5	60	5.75	\$477	\$495	\$221	\$46
Z21S2SHR	16 x 21 x 29-29.5	100	71.40	7.50	\$549	\$574	\$304	\$46
Z18S2SHR	16 x 18 x 29-29.5	100	64.05	6.75	\$525	\$551	\$277	\$46
Z16S2SHR	16 x 16 x 29-29.5	100	58.80	6	\$501	\$527	\$271	\$46
Z15S2SHR	16 x 15 x 29-29.5	100	56.70	5.75	\$473	\$494	\$244	\$46
Z12S2SHR	16 x 12 x 29-29.5	92.5	50.40	4.75	\$440	\$458	\$221	\$46

Laminate doors are standard. Includes one adjustable shelf. Standard with lock

Z36L2SHN	24 x 36 x 29-29.5	125	127	18.50	\$728	\$782	N/A	\$135
Z30L2SHN	24 x 30 x 29-29.5	125	111	15.50	\$653	\$699	N/A	\$113
Z21L2SHN	24 x 21 x 29-29.5	125	86	11	\$567	\$603	N/A	\$91
Z18L2SHN	24 x 18 x 29-29.5	100	78	9.75	\$536	\$568	N/A	\$68
Z16L2SHN	24 x 16 x 29-29.5	100	73	9	\$513	\$544	N/A	\$52
Z15L2SHN	24 x 15 x 29-29.5	100	71	8.25	\$475	\$501	N/A	\$46
Z12L2SHN	24 x 12 x 29-29.5	100	63	6.75	\$450	\$471	N/A	\$46
Z36M2SHN	20 x 36 x 29-29.5	125	111.95	15.50	\$649	\$695	N/A	\$101
Z30M2SHN	20 x 30 x 29-29.5	125	97.14	13.25	\$590	\$629	N/A	\$91
Z21M2SHN	20 x 21 x 29-29.5	125	74.40	9.50	\$491	\$523	N/A	\$68
Z18M2SHN	20 x 18 x 29-29.5	100	67.53	8.25	\$466	\$494	N/A	\$57
Z16M2SHN	20 x 16 x 29-29.5	100	62.59	7	\$439	\$466	N/A	\$46
Z15M2SHN	20 x 15 x 29-29.5	100	60.65	6.75	\$420	\$443	N/A	\$46
Z12M2SHN	20 x 12 x 29-29.5	100	55	5.75	\$390	\$409	N/A	\$46
Z36S2SHN	16 x 36 x 29-29.5	125	96.24	12.50	\$585	\$630	N/A	\$101
Z30S2SHN	16 x 30 x 29-29.5	125	82.82	10.50	\$511	\$542	N/A	\$91
Z21S2SHN	16 x 21 x 29-29.5	100	62.70	7.50	\$439	\$464	N/A	\$68
Z18S2SHN	16 x 18 x 29-29.5	100	55.99	6.75	\$424	\$451	N/A	\$57
Z16S2SHN	16 x 16 x 29-29.5	100	52.22	6	\$403	\$429	N/A	\$46
Z15S2SHN	16 x 15 x 29-29.5	100	50.34	5.75	\$381	\$401	N/A	\$46
Z12S2SHN	16 x 12 x 29-29.5	100	44.68	4.75	\$354	\$372	N/A	\$46

One adjustable shelf.

Required Specifications

- Top finish
- Handles*
- Top/edge detail
- Base finish

Optional Specifications

- Glazed doors*
- HP laminate
- Key #

STORAGE MODULES - 29" / 29.5" HIGH

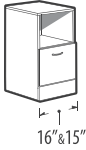
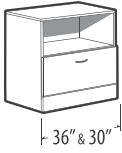

File Module with Open Shelf

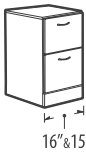

Two File Module



Two File Module



Box/Box/File Module

MODEL#	DIMENSIONS D x W x H	FREIGHT CLASS	WT./LBS.	CUBIC FT.	1" TOP	1.5" TOP	GLAZE ADD	HP ADD
Z36L2FN	24 x 36 x 29-29.5	100	153.30	18.50	\$1042	\$1095	N/A	\$135
Z30L2FN	24 x 30 x 29-29.5	100	134.40	15.50	\$941	\$987	N/A	\$113
Z16L2FN	24 x 16 x 29-29.5	100	87.15	9	\$658	\$689	N/A	\$68
Z15L2FN	24 x 15 x 29-29.5	92.5	82.95	8.25	\$619	\$645	N/A	\$57
Z36M2FN	20 x 36 x 29-29.5	100	135.45	15.50	\$964	\$1010	N/A	\$135
Z30M2FN	20 x 30 x 29-29.5	100	118.65	13.25	\$886	\$924	N/A	\$113
Z16M2FN	20 x 16 x 29-29.5	92.5	75.60	7	\$586	\$613	N/A	\$68
Z15M2FN	20 x 15 x 29-29.5	92.5	72.45	6.75	\$561	\$584	N/A	\$57
Z36S2FN	16 x 36 x 29-29.5	100	114.45	12.50	\$871	\$916	N/A	\$101
Z30S2FN	16 x 30 x 29-29.5	100	97.65	10.50	\$771	\$802	N/A	\$91
Z16S2FN	16 x 16 x 29-29.5	92.5	63	6	\$544	\$570	N/A	\$52
Z15S2FN	16 x 15 x 29-29.5	92.5	60.90	5.75	\$519	\$539	N/A	\$46

Open shelf and one file drawer on bottom. Lock secures file drawer. 36" and 30" wide models have front-to-back and side-to-side letter/legal filing capability. Side-to-side file bars included.

- 15" wide models have only side-to-side filing capability
- Lateral file drawer construction is for accommodating hanging files NOT for stacking materials on the drawer bottom

Z36L2E	24 x 36 x 29-29.5	100	164.85	18.50	\$1278	\$1331	N/A	\$135
Z30L2E	24 x 30 x 29-29.5	100	145.95	15.50	\$1168	\$1214	N/A	\$113
Z16L2E	24 x 16 x 29-29.5	92.5	95.55	9	\$752	\$783	N/A	\$68
Z15L2E	24 x 15 x 29-29.5	92.5	91.35	8.25	\$709	\$735	N/A	\$57
Z36M2E	20 x 36 x 29-29.5	100	149.10	15.50	\$1207	\$1254	N/A	\$135
Z30M2E	20 x 30 x 29-29.5	92.5	133.35	13.25	\$1120	\$1159	N/A	\$113
Z16M2E	20 x 16 x 29-29.5	85	85.05	7	\$682	\$709	N/A	\$68
Z15M2E	20 x 15 x 29-29.5	85	81.90	6.75	\$659	\$682	N/A	\$57
Z36S2E	16 x 36 x 29-29.5	92.5	128.10	12.50	\$1133	\$1178	N/A	\$101
Z30S2E	16 x 30 x 29-29.5	92.5	110.25	10.50	\$1029	\$1060	N/A	\$91
Z16S2E	16 x 16 x 29-29.5	85	73.50	6	\$677	\$703	N/A	\$52
Z15S2E	16 x 15 x 29-29.5	85	71.40	5.75	\$653	\$674	N/A	\$46

Two file drawers. Lock secures all drawers. 36" and 30" wide models have front-to-back and side-to-side letter/legal filing capability. Side-to-side file bars included.

- 15" wide models have only side-to-side filing capability
- Lateral file drawer construction is for accommodating hanging files NOT for stacking materials on the drawer bottom

Z36L2SE	24 x 36 x 29-29.5	100	180	18.50	\$1501	\$1554	N/A	\$135
Z36M2SE	20 x 36 x 29-29.5	92.5	164	15.50	\$1444	\$1491	N/A	\$135

Two lateral file drawers with steel drawer interior. Lock secures all drawers. Front-to-back and side-to-side letter/legal filing capability. Side-to-side file bars included.

- Front-to-back filing bars available separately. Order **FBB** bars. See "FBB" on page 699.
- Lateral file drawer construction is for accommodating hanging files NOT for stacking materials on the drawer bottom

Z16L2BF	24 x 16 x 29-29.5	92.5	97.65	9	\$847	\$878	N/A	\$68
Z15L2BF	24 x 15 x 29-29.5	92.5	93.45	8.25	\$808	\$834	N/A	\$68
Z16M2BF	20 x 16 x 29-29.5	85	87.15	7	\$776	\$803	N/A	\$68
Z15M2BF	20 x 15 x 29-29.5	85	84	6.75	\$756	\$779	N/A	\$68
Z16S2BF	16 x 16 x 29-29.5	85	73.50	6	\$723	\$749	N/A	\$52
Z15S2BF	16 x 15 x 29-29.5	85	71.40	5.75	\$690	\$711	N/A	\$52

Two box and one file drawer. One pencil tray. Lock secures all drawers.

Required Specifications

- Top finish
- Top/edge detail
- Handles
- Base finish

Optional Specifications

- HP laminate
- Key #
- Box drawer - no upcharge

STORAGE MODULES - 29" / 29.5" HIGH



Mixed Storage Cabinet - LEFT

MODEL#	DIMENSIONS	FREIGHT CLASS	WT/LBS.	CUBIC FT.	1" TOP	1.5" TOP	GLAZE ADD	HP ADD
D x W x H								
Z36L2XL	24 x 36 x 29-29.5	92.5	187	18.50	\$1457	\$1506	N/A	\$135
Z30L2XL	24 x 30 x 29-29.5	92.5	166	15.50	\$1329	\$1375	N/A	\$113
Z36M2XL	20 x 36 x 29-29.5	92.5	177	15.50	\$1368	\$1414	N/A	\$135
Z30M2XL	20 x 30 x 29-29.5	92.5	152	13.25	\$1260	\$1299	N/A	\$113
Z36S2XL	16 x 36 x 29-29.5	92.5	145	12.50	\$1174	\$1215	N/A	\$101
Z30S2XL	16 x 30 x 29-29.5	92.5	124	10.50	\$1052	\$1087	N/A	\$91

Two box drawers on **left**, one file drawer on **right** and one lateral file drawer on bottom. Right lock secures one file drawer, the left lock secures two box and lateral file. One pencil tray. Front-to-back and side-to-side letter/legal filing capability. Side-to-side file bars included.

- Lateral file drawer construction is for accommodating hanging files NOT for stacking materials on the drawer bottom



Mixed Storage Cabinet - RIGHT

Z36L2XR	24 x 36 x 29-29.5	92.5	187	18.50	\$1457	\$1506	N/A	\$135
Z30L2XR	24 x 30 x 29-29.5	92.5	166	15.50	\$1329	\$1375	N/A	\$113
Z36M2XR	20 x 36 x 29-29.5	92.5	177	15.50	\$1368	\$1414	N/A	\$135
Z30M2XR	20 x 30 x 29-29.5	92.5	152	13.25	\$1260	\$1299	N/A	\$113
Z36S2XR	16 x 36 x 29-29.5	92.5	145	12.50	\$1174	\$1215	N/A	\$101
Z30S2XR	16 x 30 x 29-29.5	92.5	124	10.50	\$1052	\$1087	N/A	\$91

Two box drawers on **right**, one file drawer on **left** and one lateral file drawer on bottom. Right lock secures two box and lateral file, the left lock secures one file drawer. One pencil tray. Front-to-back and side-to-side letter/legal filing capability. Side-to-side file bars included.

- Lateral file drawer construction is for accommodating hanging files NOT for stacking materials on the drawer bottom

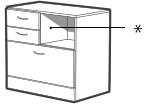

Mixed Drawer Cabinet with Open Shelf - LEFT*



* Accepts collator

Z36L2XNL	24 x 36 x 29-29.5	100	176.40	18.50	\$1262	\$1316	N/A	\$135
Z30L2XNL	24 x 30 x 29-29.5	92.5	155.40	15.50	\$1159	\$1205	N/A	\$113
Z36M2XNL	20 x 36 x 29-29.5	92.5	157.50	15.50	\$1180	\$1226	N/A	\$135
Z30M2XNL	20 x 30 x 29-29.5	92.5	138.60	13.25	\$1092	\$1131	N/A	\$113
Z36S2XNL	16 x 36 x 29-29.5	92.5	128.10	12.50	\$1058	\$1096	N/A	\$101
Z30S2XNL	16 x 30 x 29-29.5	92.5	114.45	10.50	\$959	\$986	N/A	\$91

Two box drawers on **left**, open shelf on **right** and one lateral file drawer on bottom. Right lock secures two box and one file drawer, the left lock secures the lateral file. One pencil tray. Front-to-back and side-to-side letter/legal filing capability. Side-to-side file bars included.

- Lateral file drawer construction is for accommodating hanging files NOT for stacking materials on the drawer bottom

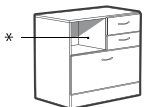

Mixed Drawer Cabinet with Open Shelf - RIGHT*



* Accepts collator

Z36L2XNR	24 x 36 x 29-29.5	100	176.40	18.50	\$1262	\$1316	N/A	\$135
Z30L2XNR	24 x 30 x 29-29.5	92.5	155.40	15.50	\$1159	\$1205	N/A	\$113
Z36M2XNR	20 x 36 x 29-29.5	92.5	157.50	15.50	\$1180	\$1226	N/A	\$135
Z30M2XNR	20 x 30 x 29-29.5	92.5	138.60	13.25	\$1092	\$1131	N/A	\$113
Z36S2XNR	16 x 36 x 29-29.5	92.5	128.10	12.50	\$1058	\$1096	N/A	\$101
Z30S2XNR	16 x 30 x 29-29.5	92.5	114.45	10.50	\$959	\$986	N/A	\$91

Two box drawers on **right**, open shelf on **left** and one lateral file drawer on bottom. Right lock secures two box and one file drawer, the left lock secures the lateral file. One pencil tray. Front-to-back and side-to-side letter/legal filing capability. Side-to-side file bars included.

- Lateral file drawer construction is for accommodating hanging files NOT for stacking materials on the drawer bottom



Media Center - LEFT

Z36L2MCL	24 x 36 x 29-29.5	100	171.15	18.50	\$1360	\$1414	N/A	\$135
Z30L2MCL	24 x 30 x 29-29.5	100	152.25	15.50	\$1266	\$1312	N/A	\$113
Z36M2MCL	20 x 36 x 29-29.5	100	153.30	15.50	\$1276	\$1322	N/A	\$135
Z30M2MCL	20 x 30 x 29-29.5	92.5	134.40	13.25	\$1163	\$1202	N/A	\$113
Z36S2MCL	16 x 36 x 29-29.5	92.5	126	12.50	\$1158	\$1203	N/A	\$101
Z30S2MCL	16 x 30 x 29-29.5	92.5	108.15	10.50	\$1045	\$1076	N/A	\$91

Accommodates pc, keyboard, monitor, hanging folders and accessories and/or printer. One vertical drawer on the **left**. Pull out keyboard shelf. Adjustable pull out bottom shelf accommodates pc and/or printer. Grommet in worksurface and back panel. Lock secures vertical drawer.

Required Specifications

Top finish
Top/edge detail
Base finish
Handles

Optional Specifications

HP laminate
Key #
Box drawer - no upcharge
Collator*

STORAGE MODULES - 29" / 29.5" HIGH

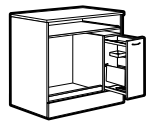

Media Center - RIGHT

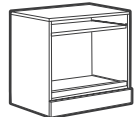

PC Center

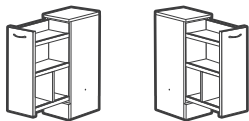

LEFT RIGHT
Vertical Utility Drawer

MODEL#	DIMENSIONS D x W x H	FREIGHT CLASS	WT./LBS.	CUBIC FT.	1" TOP	1.5" TOP	GLAZE ADD	HP ADD
Z36L2MCR	24 x 36 x 29-29.5	100	171.15	18.50	\$1360	\$1414	N/A	\$135
Z30L2MCR	24 x 30 x 29-29.5	100	152.25	15.50	\$1266	\$1312	N/A	\$113
Z36M2MCR	20 x 36 x 29-29.5	100	153.30	15.50	\$1276	\$1322	N/A	\$135
Z30M2MCR	20 x 30 x 29-29.5	92.5	134.40	13.25	\$1163	\$1202	N/A	\$113
Z36S2MCR	16 x 36 x 29-29.5	92.5	126	12.50	\$1158	\$1203	N/A	\$101
Z30S2MCR	16 x 30 x 29-29.5	92.5	108.15	10.50	\$1045	\$1076	N/A	\$91

Accommodates pc, keyboard, monitor, hanging folders and accessories and/or printer. One vertical drawer on the **right**. Pull out keyboard shelf. Adjustable pull out bottom shelf accommodates pc and/or printer. Grommet in worksurface and back panel. Lock secures vertical drawer.

Z36L2PC	24 x 36 x 29-29.5	100	148.05	18.50	\$890	\$943	N/A	\$135
Z30L2PC	24 x 30 x 29-29.5	100	127.05	15.50	\$802	\$848	N/A	\$113
Z36M2PC	20 x 36 x 29-29.5	100	132.30	15.50	\$826	\$873	N/A	\$101
Z30M2PC	20 x 30 x 29-29.5	100	114.45	13.25	\$738	\$776	N/A	\$91
Z36S2PC	16 x 36 x 29-29.5	100	110.25	12.50	\$752	\$797	N/A	\$101
Z30S2PC	16 x 30 x 29-29.5	100	92.40	10.50	\$641	\$672	N/A	\$91

Accommodates pc, keyboard, monitor and/or printer. Pull out keyboard shelf. Adjustable pull out bottom shelf accommodates pc and/or printer. Grommet in worksurface and back panel.

Z12L2VDL	24 x 12 x 29-29.5	85	95.55	6.75	\$707	\$728	N/A	\$46
Z12M2VDL	20 x 12 x 29-29.5	85	80.85	5.75	\$616	\$634	N/A	\$46
Z12S2VDL	16 x 12 x 29-29.5	85	68.25	4.75	\$550	\$568	N/A	\$46
Z12L2VDR	24 x 12 x 29-29.5	85	95.55	6.75	\$707	\$728	N/A	\$46
Z12M2VDR	20 x 12 x 29-29.5	85	80.85	5.75	\$616	\$634	N/A	\$46
Z12S2VDR	16 x 12 x 29-29.5	85	68.25	4.75	\$550	\$568	N/A	\$46

Specify **VDL** models for **LEFT** or **VDR** models for **RIGHT**

One vertical drawer. Lock secures vertical drawer.

STORAGE MODULES - 40.8" / 41.3" HIGH

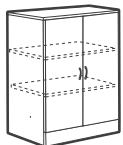

Glazed door option

Storage Cabinet with Doors*

Z36L4SH	24 x 36 x 40.8-41.3	125	185.85	25	\$1127	\$1181	\$718	\$135
Z30L4SH	24 x 30 x 40.8-41.3	125	161.70	21.25	\$1032	\$1077	\$627	\$113
Z36M4SH	20 x 36 x 40.8-41.3	125	165.90	21.25	\$1052	\$1099	\$718	\$135
Z30M4SH	20 x 30 x 40.8-41.3	125	143.85	18	\$951	\$990	\$627	\$113
Z36S4SH	16 x 36 x 40.8-41.3	100	142.80	17.50	\$952	\$997	\$718	\$101
Z30S4SH	16 x 30 x 40.8-41.3	100	121.80	14.50	\$854	\$885	\$627	\$57

Laminate doors are standard. **Includes two 3-position fixed/height adjustable shelves.** Standard with lock.

Required Specifications

- Top finish
- Top/edge detail
- Handles*
- Base finish

Optional Specifications

- HP laminate
- Glazed doors*
- Key #

STORAGE MODULES - 40.8" / 41.3" HIGH

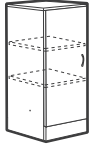

Glazed door option

Storage Cabinet with Door - LEFT*

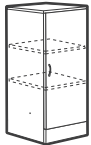

Glazed door option

Storage Cabinet with Door - RIGHT*

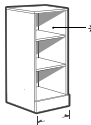

21", 18", 16", 15" & 12"

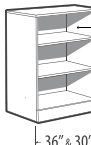

36" & 30"



* Accepts collator 11" high
** Accepts collator 11.3" high

Open Storage Cabinet**

MODEL#	DIMENSIONS	FREIGHT CLASS	WT/LBS.	CUBIC FT.	1" TOP	1.5" TOP	GLAZE ADD	HP ADD
D x W x H								
Z21L4SHL	24 x 21 x 40.8-41.3	100	123.90	15.25	\$835	\$872	\$394	\$91
Z18L4SHL	24 x 18 x 40.8-41.3	100	112.35	13.25	\$786	\$817	\$355	\$68
Z16L4SHL	24 x 16 x 40.8-41.3	100	105	12	\$739	\$771	\$350	\$68
Z15L4SHL	24 x 15 x 40.8-41.3	100	100.80	11.25	\$708	\$733	\$310	\$68
Z12L4SHL	24 x 12 x 40.8-41.3	100	89.25	9.25	\$656	\$677	\$280	\$46
Z21M4SHL	20 x 21 x 40.8-41.3	100	116.55	13	\$753	\$785	\$394	\$91
Z18M4SHL	20 x 18 x 40.8-41.3	100	98.70	11.25	\$712	\$739	\$355	\$68
Z16M4SHL	20 x 16 x 40.8-41.3	100	91.35	10.25	\$668	\$695	\$350	\$57
Z15M4SHL	20 x 15 x 40.8-41.3	100	88.20	9.50	\$640	\$661	\$310	\$57
Z12M4SHL	20 x 12 x 40.8-41.3	100	78.75	8	\$595	\$613	\$280	\$46
Z21S4SHL	16 x 21 x 40.8-41.3	100	94.50	10.50	\$672	\$698	\$394	\$68
Z18S4SHL	16 x 18 x 40.8-41.3	100	84	9.50	\$645	\$671	\$355	\$57
Z16S4SHL	16 x 16 x 40.8-41.3	100	76.65	8.50	\$604	\$630	\$350	\$57
Z15S4SHL	16 x 15 x 40.8-41.3	100	73.50	8	\$571	\$592	\$310	\$57
Z12S4SHL	16 x 12 x 40.8-41.3	92.5	65.10	6.50	\$529	\$546	\$280	\$46

Laminate doors are standard. Includes two 3-position fixed/height adjustable shelves. Standard with lock.

Z21L4SHR	24 x 21 x 40.8-41.3	100	123.90	15.25	\$835	\$872	\$394	\$91
Z18L4SHR	24 x 18 x 40.8-41.3	100	112.35	13.25	\$786	\$817	\$355	\$68
Z16L4SHR	24 x 16 x 40.8-41.3	100	105	12	\$739	\$771	\$350	\$68
Z15L4SHR	24 x 15 x 40.8-41.3	100	100.80	11.25	\$708	\$733	\$310	\$68
Z12L4SHR	24 x 12 x 40.8-41.3	100	89.25	9.25	\$656	\$677	\$280	\$46
Z21M4SHR	20 x 21 x 40.8-41.3	100	116.55	13	\$753	\$785	\$394	\$91
Z18M4SHR	20 x 18 x 40.8-41.3	100	98.70	11.25	\$712	\$739	\$355	\$68
Z16M4SHR	20 x 16 x 40.8-41.3	100	91.35	10.25	\$668	\$695	\$350	\$57
Z15M4SHR	20 x 15 x 40.8-41.3	100	88.20	9.50	\$640	\$661	\$310	\$57
Z12M4SHR	20 x 12 x 40.8-41.3	100	78.75	8	\$595	\$613	\$280	\$46
Z21S4SHR	16 x 21 x 40.8-41.3	100	94.50	10.50	\$672	\$698	\$394	\$68
Z18S4SHR	16 x 18 x 40.8-41.3	100	84	9.50	\$645	\$671	\$355	\$57
Z16S4SHR	16 x 16 x 40.8-41.3	100	76.65	8.50	\$604	\$630	\$350	\$57
Z15S4SHR	16 x 15 x 40.8-41.3	100	73.50	8	\$571	\$592	\$310	\$57
Z12S4SHR	16 x 12 x 40.8-41.3	92.5	65.10	6.50	\$529	\$546	\$280	\$46

Laminate doors are standard. Includes two 3-position fixed/height adjustable shelves. Standard with lock.

Z36L4SHN	24 x 36 x 40.8-41.3	125	162.55	25	\$887	\$940	N/A	\$135
Z30L4SHN	24 x 30 x 40.8-41.3	125	142.46	21.25	\$817	\$863	N/A	\$113
Z21L4SHN	24 x 21 x 40.8-41.3	125	111.80	15.25	\$701	\$737	N/A	\$91
Z18L4SHN	24 x 18 x 40.8-41.3	125	101.23	13.25	\$662	\$694	N/A	\$68
Z16L4SHN	24 x 16 x 40.8-41.3	125	94.53	12	\$617	\$648	N/A	\$68
Z15L4SHN	24 x 15 x 40.8-41.3	100	91.70	11.25	\$598	\$624	N/A	\$68
Z12L4SHN	24 x 12 x 40.8-41.3	100	81.13	9.25	\$554	\$575	N/A	\$46
Z36M4SHN	20 x 36 x 40.8-41.3	125	141.59	21.25	\$811	\$857	N/A	\$135
Z30M4SHN	20 x 30 x 40.8-41.3	125	123.94	18	\$737	\$776	N/A	\$113
Z21M4SHN	20 x 21 x 40.8-41.3	125	102.19	13	\$619	\$651	N/A	\$91
Z18M4SHN	20 x 18 x 40.8-41.3	125	86.54	11.25	\$590	\$617	N/A	\$68
Z16M4SHN	20 x 16 x 40.8-41.3	125	81.01	10.25	\$546	\$573	N/A	\$68
Z15M4SHN	20 x 15 x 40.8-41.3	100	78.24	9.50	\$530	\$551	N/A	\$68
Z12M4SHN	20 x 12 x 40.8-41.3	100	69.95	8	\$493	\$511	N/A	\$46
Z36S4SHN	16 x 36 x 40.8-41.3	125	119.57	17.50	\$710	\$756	N/A	\$101
Z30S4SHN	16 x 30 x 40.8-41.3	125	111.72	14.50	\$640	\$672	N/A	\$91
Z21S4SHN	16 x 21 x 40.8-41.3	125	81.04	10.50	\$538	\$563	N/A	\$68
Z18S4SHN	16 x 18 x 40.8-41.3	125	72.91	9.50	\$521	\$548	N/A	\$57
Z16S4SHN	16 x 16 x 40.8-41.3	125	67.49	8.50	\$482	\$508	N/A	\$57
Z15S4SHN	16 x 15 x 40.8-41.3	100	64.78	8	\$461	\$481	N/A	\$57
Z12S4SHN	16 x 12 x 40.8-41.3	100	57.71	6.50	\$427	\$445	N/A	\$46

Includes two 3-position fixed/height adjustable shelves.

Required Specifications

- Top finish
- Top/edge detail
- Handles*
- Base finish

Optional Specifications

- Glazed door*
- HP laminate
- Collator**

STORAGE MODULES - 40.8" / 41.3" HIGH

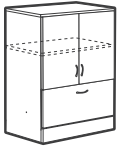

Glazed door option

File Module with Doors*

MODEL#	DIMENSIONS D x W x H	FREIGHT CLASS	WT./LBS.	CUBIC FT.	1" TOP	1.5" TOP	GLAZE ADD	HP ADD
Z36L4F	24 x 36 x 40.8-41.3	100	204.75	25	\$1399	\$1453	\$560	\$135
Z30L4F	24 x 30 x 40.8-41.3	100	179.55	21.25	\$1293	\$1339	\$494	\$113
Z36M4F	20 x 36 x 40.8-41.3	100	183.75	21.25	\$1319	\$1365	\$560	\$135
Z30M4F	20 x 30 x 40.8-41.3	100	160.65	18	\$1212	\$1251	\$494	\$113
Z36S4F	16 x 36 x 40.8-41.3	100	148.05	17.50	\$1190	\$1235	\$560	\$101
Z30S4F	16 x 30 x 40.8-41.3	100	133.35	14.50	\$1077	\$1108	\$494	\$91

One lateral file drawer. Laminate doors are standard. **Includes one 3-position fixed/height adjustable shelf.** Upper lock secures storage compartment. Lower lock secures one file drawer. Front-to-back and side-to-side letter/legal filing capability. Side-to-side file bars included.

- Lateral file drawer construction is for accommodating hanging files NOT for stacking materials on the drawer bottom.

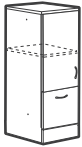

Glazed door option

File Module with Door - LEFT*

Z16L4FL	24 x 16 x 40.8-41.3	100	116.55	12	\$868	\$899	\$271	\$68
Z15L4FL	24 x 15 x 40.8-41.3	100	111.30	11.25	\$835	\$861	\$244	\$68
Z16M4FL	20 x 16 x 40.8-41.3	100	101.85	10.25	\$808	\$835	\$271	\$68
Z15M4FL	20 x 15 x 40.8-41.3	92.5	100.80	9.50	\$774	\$795	\$244	\$68
Z16S4FL	16 x 16 x 40.8-41.3	150	84	17.50	\$721	\$747	\$271	\$57
Z15S4FL	16 x 15 x 40.8-41.3	150	82.95	14.50	\$695	\$715	\$244	\$57

One file drawer. Laminate door is standard. **Includes one 3-position fixed/height adjustable shelf.** Upper lock secures storage compartment. Lower lock secures one file drawer.



Glazed door option

File Module with Door - RIGHT*

Z16L4FR	24 x 16 x 40.8-41.3	100	116.55	12	\$868	\$899	\$271	\$68
Z15L4FR	24 x 15 x 40.8-41.3	100	111.30	11.25	\$835	\$861	\$244	\$68
Z16M4FR	20 x 16 x 40.8-41.3	100	101.85	10.25	\$808	\$835	\$271	\$68
Z15M4FR	20 x 15 x 40.8-41.3	92.5	100.80	9.50	\$774	\$795	\$244	\$68
Z16S4FR	16 x 16 x 40.8-41.3	150	84	17.50	\$721	\$747	\$271	\$57
Z15S4FR	16 x 15 x 40.8-41.3	150	82.95	14.50	\$695	\$715	\$244	\$57

One file drawer. Laminate door is standard. **Includes one 3-position fixed/height adjustable shelf.** Upper lock secures storage compartment. Lower lock secures one file drawer.

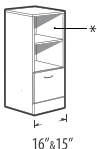
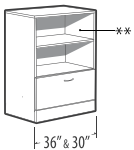

* Accepts collator 11" high
** Accepts collator 11.3" high

File Module with Open Shelves**

Z36L4FN	24 x 36 x 40.8-41.3	125	189.43	25	\$1202	\$1239	N/A	\$135
Z30L4FN	24 x 30 x 40.8-41.3	125	166.96	21.25	\$1115	\$1147	N/A	\$113
Z16L4FN	24 x 16 x 40.8-41.3	100	109.63	12	\$766	\$798	N/A	\$68
Z15L4FN	24 x 15 x 40.8-41.3	100	105.53	11.25	\$743	\$769	N/A	\$68
Z36M4FN	20 x 36 x 40.8-41.3	125	167.42	21.25	\$1122	\$1168	N/A	\$135
Z30M4FN	20 x 30 x 40.8-41.3	100	147.39	18	\$1034	\$1072	N/A	\$113
Z16M4FN	20 x 16 x 40.8-41.3	100	95.06	10.25	\$707	\$734	N/A	\$68
Z15M4FN	20 x 15 x 40.8-41.3	100	94.17	9.50	\$681	\$704	N/A	\$68
Z36S4FN	16 x 36 x 40.8-41.3	125	132.80	17.50	\$993	\$1038	N/A	\$101
Z30S4FN	16 x 30 x 40.8-41.3	100	119.42	14.50	\$897	\$928	N/A	\$91
Z16S4FN	16 x 16 x 40.8-41.3	100	78.39	8.50	\$599	\$625	N/A	\$57
Z15S4FN	16 x 15 x 40.8-41.3	100	76.51	8	\$584	\$605	N/A	\$57

Two open shelves and one file drawer on bottom. **Includes one 3-position fixed/height adjustable shelf.** Lock secures one file drawer. 36" and 30" wide models have front-to-back and side-to-side letter/legal filing capability. Side-to-side file bars included.

- Lateral file drawer construction is for accommodating hanging files NOT for stacking materials on the drawer bottom.

Required Specifications

Top finish
Top/edge detail
Handles
Base finish

Optional Specifications

Glazed doors*
HP laminate
Box drawer - no upcharge
Collator**

STORAGE MODULES - 40.8" / 41.3" HIGH

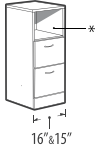
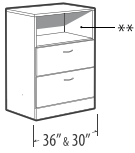

* Accepts collator 11" high
 ** Accepts collator 11.3" high

Two File Module with Open Shelf*

MODEL#	DIMENSIONS	FREIGHT CLASS	WT/LBS.	CUBIC FT.	1" TOP	1.5" TOP	GLAZE ADD	HP ADD
D x W x H								
Z36L4EN	24 x 36 x 40.8-41.3	125	199.50	25	\$1434	\$1487	N/A	\$135
Z30L4EN	24 x 30 x 40.8-41.3	100	178.50	21.25	\$1369	\$1414	N/A	\$113
Z16L4EN	24 x 16 x 40.8-41.3	100	116.55	12	\$860	\$892	N/A	\$68
Z15L4EN	24 x 15 x 40.8-41.3	100	112.35	11.25	\$836	\$862	N/A	\$68
Z36M4EN	20 x 36 x 40.8-41.3	100	182	21.25	\$1367	\$1413	N/A	\$135
Z30M4EN	20 x 30 x 40.8-41.3	100	163	18	\$1297	\$1335	N/A	\$113
Z16M4EN	20 x 16 x 40.8-41.3	92.5	105	10.25	\$791	\$818	N/A	\$68
Z15M4EN	20 x 15 x 40.8-41.3	92.5	101	9.50	\$769	\$790	N/A	\$68
Z36S4EN	16 x 36 x 40.8-41.3	100	153.30	17.50	\$1254	\$1299	N/A	\$101
Z30S4EN	16 x 30 x 40.8-41.3	100	131.25	14.50	\$1141	\$1172	N/A	\$91
Z16S4EN	16 x 16 x 40.8-41.3	92.5	85.05	8.50	\$726	\$752	N/A	\$57
Z15S4EN	16 x 15 x 40.8-41.3	92.5	82.95	8	\$707	\$727	N/A	\$57

Open fixed shelf and two file drawers on bottom. Lock secures all drawers. 36" and 30" wide models have front-to-back and side-to-side letter/legal filing capability. Side-to-side file bars included.

- Lateral file drawer construction is for accommodating hanging files NOT for stacking materials on the drawer bottom.



Three File Module

Z36L43F	24 x 36 x 40.8-41.3	100	210	25	\$1686	\$1739	N/A	\$135
Z30L43F	24 x 30 x 40.8-41.3	100	190.05	21.25	\$1601	\$1647	N/A	\$113
Z16L43F	24 x 16 x 40.8-41.3	92.5	126	12	\$990	\$1021	N/A	\$57
Z15L43F	24 x 15 x 40.8-41.3	92.5	120.75	11.25	\$963	\$989	N/A	\$57
Z36M43F	20 x 36 x 40.8-41.3	100	198.45	21.25	\$1641	\$1687	N/A	\$135
Z30M43F	20 x 30 x 40.8-41.3	100	177.45	18	\$1532	\$1571	N/A	\$113
Z16M43F	20 x 16 x 40.8-41.3	92.5	114.45	10.25	\$923	\$950	N/A	\$57
Z15M43F	20 x 15 x 40.8-41.3	92.5	110.25	9.50	\$900	\$921	N/A	\$57
Z36S43F	16 x 36 x 40.8-41.3	100	165.90	17.50	\$1481	\$1526	N/A	\$101
Z30S43F	16 x 30 x 40.8-41.3	92.5	148.05	14.50	\$1364	\$1396	N/A	\$91
Z16S43F	16 x 16 x 40.8-41.3	92.5	94.50	8.50	\$873	\$899	N/A	\$57
Z15S43F	16 x 15 x 40.8-41.3	92.5	91.35	8	\$843	\$864	N/A	\$57

Three file drawers. Lock secures all drawers. 36" and 30" wide models have front-to-back and side-to-side letter/legal filing capability. Side-to-side file bars included.

- Lateral file drawer construction is for accommodating hanging files NOT for stacking materials on the drawer bottom.



Three File Module

Z36L4S3F	24 x 36 x 40.8-41.3	100	233	25	\$1994	\$2047	N/A	\$135
Z36M4S3F	20 x 36 x 40.8-41.3	92.5	221	21.25	\$1928	\$1975	N/A	\$113

Three lateral file drawers with steel drawer interior. Lock secures all drawers. Front-to-back and side-to-side letter/legal filing capability. Side-to-side file bars included.

- Front-to-back filing bars available separately. Order **FBB** bars. See "FBB" on page 699.
- Lateral file drawer construction is for accommodating hanging files NOT for stacking materials on the drawer bottom.

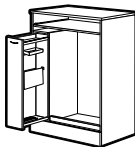

Media Center - LEFT

Z36L4MCL	24 x 36 x 40.8-41.3	100	206.85	25	\$1535	\$1588	N/A	\$135
Z30L4MCL	24 x 30 x 40.8-41.3	100	185.85	21.25	\$1447	\$1493	N/A	\$113
Z36M4MCL	20 x 36 x 40.8-41.3	100	172.20	21.25	\$1342	\$1388	N/A	\$135
Z30M4MCL	20 x 30 x 40.8-41.3	100	153.30	18	\$1253	\$1292	N/A	\$113
Z36S4MCL	16 x 36 x 40.8-41.3	100	172	17.50	\$1287	\$1333	N/A	\$101
Z30S4MCL	16 x 30 x 40.8-41.3	92.5	153	14.50	\$1176	\$1208	N/A	\$91

Standing height unit, accommodates pc, keyboard, monitor, hanging folders and accessories and/or printer. One vertical drawer on the **left**. Pull out keyboard shelf. Adjustable pull out bottom shelf accommodates pc and/or printer. Grommet in worksurface and back panel. Lock secures vertical drawer.

Required Specifications

- Top finish
- Top/edge detail
- Handles
- Base finish

Optional Specifications

- HP laminate
- Box drawer - no upcharge (*not available on units with steel drawers*)
- Collator*

STORAGE MODULES - 40.8" / 41.3" HIGH

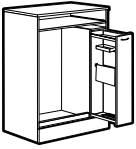

Media Center - RIGHT

MODEL#	DIMENSIONS D x W x H	FREIGHT CLASS	WT/LBS.	CUBIC FT.	1" TOP	1.5" TOP	GLAZE ADD	HP ADD
Z36L4MCR	24 x 36 x 40.8-41.3	100	206.85	25	\$1535	\$1588	N/A	\$135
Z30L4MCR	24 x 30 x 40.8-41.3	100	185.85	21.25	\$1447	\$1493	N/A	\$113
Z36M4MCR	20 x 36 x 40.8-41.3	100	172.20	21.25	\$1342	\$1388	N/A	\$135
Z30M4MCR	20 x 30 x 40.8-41.3	100	153.30	18	\$1253	\$1292	N/A	\$113
Z36S4MCR	16 x 36 x 40.8-41.3	100	172	17.50	\$1287	\$1333	N/A	\$101
Z30S4MCR	16 x 30 x 40.8-41.3	92.5	153	14.50	\$1176	\$1208	N/A	\$91

Standing height unit, accommodates pc, keyboard, monitor, hanging folders and accessories and/or printer. One vertical drawer on the **right**. Pull out keyboard shelf. Adjustable pull out bottom shelf accommodates pc and/or printer. Grommet in worksurface and back panel. Lock secures vertical drawer.

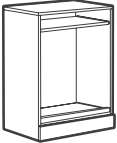

PC Center

Z36L4PC	24 x 36 x 40.8-41.3	125	169.05	25	\$985	\$1039	N/A	\$135
Z30L4PC	24 x 30 x 40.8-41.3	125	147	21.25	\$894	\$940	N/A	\$113
Z36M4PC	20 x 36 x 40.8-41.3	125	152.25	21.25	\$934	\$980	N/A	\$135
Z30M4PC	20 x 30 x 40.8-41.3	125	132.30	18	\$828	\$867	N/A	\$113
Z36S4PC	16 x 36 x 40.8-41.3	100	150	17.50	\$829	\$874	N/A	\$101
Z30S4PC	16 x 30 x 40.8-41.3	100	129	14.50	\$718	\$749	N/A	\$91

Standing height unit, accommodates pc, keyboard, monitor and/or printer. Pull out keyboard shelf. Adjustable pull out bottom shelf accommodates pc and/or printer. Grommet in worksurface and back panel.

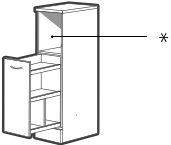

Vertical Utility Drawer - LEFT*

Z12L4VDNL	24 x 12 x 40.8-41.3	85	117.60	9.25	\$811	\$834	N/A	\$46
Z12M4VDNL	20 x 12 x 40.8-41.3	85	98.70	8	\$718	\$736	N/A	\$46
Z12S4VDNL	16 x 12 x 40.8-41.3	85	82.95	6.50	\$627	\$645	N/A	\$46

One vertical drawer. Lock secures vertical drawer.

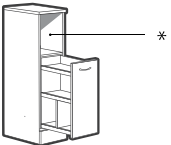

Vertical Utility Drawer - RIGHT*

Z12L4VDNR	24 x 12 x 40.8-41.3	85	117.60	9.25	\$811	\$834	N/A	\$46
Z12M4VDNR	20 x 12 x 40.8-41.3	85	98.70	8	\$718	\$736	N/A	\$46
Z12S4VDNR	16 x 12 x 40.8-41.3	85	82.95	6.50	\$627	\$645	N/A	\$46

One vertical drawer. Lock secures vertical drawer.

STORAGE MODULES - 52.5" / 53" HIGH

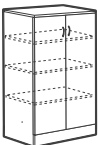

Storage Cabinet with Doors**

Z36L5SH	24 x 36 x 52.5-53	125	229.95	31.25	\$1359	\$1412	\$881	\$135
Z30L5SH	24 x 30 x 52.5-53	125	199.50	27	\$1237	\$1283	\$766	\$113
Z36M5SH	20 x 36 x 52.5-53	125	203.70	27	\$1266	\$1312	\$881	\$135
Z30M5SH	20 x 30 x 52.5-53	100	184.80	22.75	\$1110	\$1148	\$766	\$113
Z36S5SH	16 x 36 x 52.5-53	100	175.35	21.75	\$1186	\$1231	\$881	\$101
Z30S5SH	16 x 30 x 52.5-53	100	152.25	18.50	\$1038	\$1069	\$766	\$91

Laminate doors are standard. **Includes three 3-position fixed/height adjustable shelves.** Standard with lock.

Required Specifications

- Top finish
- Top/edge detail
- Handles
- Base finish

Optional Specifications

- HP laminate
- Collator*
- Glazed doors**

STORAGE MODULES - 52.5" / 53" HIGH

MODEL#	DIMENSIONS	FREIGHT CLASS	WT/LBS.	CUBIC FT.	1" TOP	1.5" TOP	GLAZE ADD	HP ADD
D x W x H								
Z21L5SHL	24 x 21 x 52.5-53	125	154.35	19.50	\$977	\$1014	\$487	\$91
Z18L5SHL	24 x 18 x 52.5-53	100	139.65	17	\$932	\$964	\$437	\$68
Z16L5SHL	24 x 16 x 52.5-53	100	130.20	15.50	\$881	\$913	\$433	\$68
Z15L5SHL	24 x 15 x 52.5-53	100	124.95	14.25	\$840	\$866	\$380	\$68
Z12L5SHL	24 x 12 x 52.5-53	100	110.25	11.75	\$783	\$804	\$342	\$46
Z21M5SHL	20 x 21 x 52.5-53	100	142.80	16.50	\$894	\$926	\$487	\$91
Z18M5SHL	20 x 18 x 52.5-53	100	122.85	14.25	\$847	\$875	\$437	\$68
Z16M5SHL	20 x 16 x 52.5-53	100	113.40	13	\$803	\$830	\$433	\$68
Z15M5SHL	20 x 15 x 52.5-53	100	109.20	12.25	\$762	\$785	\$380	\$68
Z12M5SHL	20 x 12 x 52.5-53	100	96.60	10	\$706	\$725	\$342	\$46
Z21S5SHL	16 x 21 x 52.5-53	100	116.55	13.25	\$832	\$857	\$487	\$68
Z18S5SHL	16 x 18 x 52.5-53	100	103.95	11.50	\$791	\$817	\$437	\$57
Z16S5SHL	16 x 16 x 52.5-53	100	96.60	10.50	\$749	\$775	\$433	\$57
Z15S5SHL	16 x 15 x 52.5-53	100	91.35	9.75	\$720	\$740	\$380	\$57
Z12S5SHL	16 x 12 x 52.5-53	100	79.80	8.25	\$662	\$680	\$342	\$46

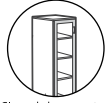
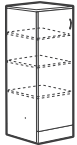

Glazed door option

Storage Cabinet with Door - LEFT**

Laminate doors are standard. Includes three 3-position fixed/height adjustable shelves. Standard with lock.

Z21L5SHR	24 x 21 x 52.5-53	125	154.35	19.50	\$977	\$1014	\$487	\$91
Z18L5SHR	24 x 18 x 52.5-53	100	139.65	17	\$932	\$964	\$437	\$68
Z16L5SHR	24 x 16 x 52.5-53	100	130.20	15.50	\$881	\$913	\$433	\$68
Z15L5SHR	24 x 15 x 52.5-53	100	124.95	14.25	\$840	\$866	\$380	\$68
Z12L5SHR	24 x 12 x 52.5-53	100	110.25	11.75	\$783	\$804	\$342	\$46
Z21M5SHR	20 x 21 x 52.5-53	100	142.80	16.50	\$894	\$926	\$487	\$91
Z18M5SHR	20 x 18 x 52.5-53	100	122.85	14.25	\$847	\$875	\$437	\$68
Z16M5SHR	20 x 16 x 52.5-53	100	113.40	13	\$803	\$830	\$433	\$68
Z15M5SHR	20 x 15 x 52.5-53	100	109.20	12.25	\$762	\$785	\$380	\$68
Z12M5SHR	20 x 12 x 52.5-53	100	96.60	10	\$706	\$725	\$342	\$46
Z21S5SHR	16 x 21 x 52.5-53	100	116.55	13.25	\$832	\$857	\$487	\$68
Z18S5SHR	16 x 18 x 52.5-53	100	103.95	11.50	\$791	\$817	\$437	\$57
Z16S5SHR	16 x 16 x 52.5-53	100	96.60	10.50	\$749	\$775	\$433	\$57
Z15S5SHR	16 x 15 x 52.5-53	100	91.35	9.75	\$720	\$740	\$380	\$57
Z12S5SHR	16 x 12 x 52.5-53	100	79.80	8.25	\$662	\$680	\$342	\$46

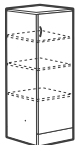

Glazed door option

Storage Cabinet with Door - RIGHT**

Laminate doors are standard. Includes three 3-position fixed/height adjustable shelves. Standard with lock.

Z36L5SHN	24 x 36 x 52.5-53	125	198.49	31.25	\$1057	\$1111	N/A	\$135
Z30L5SHN	24 x 30 x 52.5-53	125	173.45	27	\$987	\$1033	N/A	\$113
Z21L5SHN	24 x 21 x 52.5-53	125	136.43	19.50	\$811	\$848	N/A	\$91
Z18L5SHN	24 x 18 x 52.5-53	125	124.44	17	\$779	\$811	N/A	\$68
Z16L5SHN	24 x 16 x 52.5-53	125	116.10	15.50	\$729	\$760	N/A	\$68
Z15L5SHN	24 x 15 x 52.5-53	125	112.45	14.25	\$704	\$730	N/A	\$68
Z12L5SHN	24 x 12 x 52.5-53	100	100.46	11.75	\$658	\$679	N/A	\$46
Z36M5SHN	20 x 36 x 52.5-53	125	172.27	27	\$962	\$1009	N/A	\$135
Z30M5SHN	20 x 30 x 52.5-53	125	158.08	22.75	\$860	\$899	N/A	\$113
Z21M5SHN	20 x 21 x 52.5-53	125	123.68	16.50	\$726	\$758	N/A	\$91
Z18M5SHN	20 x 18 x 52.5-53	125	106.61	14.25	\$693	\$721	N/A	\$68
Z16M5SHN	20 x 16 x 52.5-53	125	99.43	13	\$648	\$675	N/A	\$68
Z15M5SHN	20 x 15 x 52.5-53	125	95.84	12.25	\$625	\$648	N/A	\$68
Z12M5SHN	20 x 12 x 52.5-53	100	85.07	10	\$581	\$600	N/A	\$46
Z36S5SHN	16 x 36 x 52.5-53	125	145.01	21.75	\$839	\$884	N/A	\$101
Z30S5SHN	16 x 30 x 52.5-53	125	126.96	18.50	\$756	\$787	N/A	\$91
Z21S5SHN	16 x 21 x 52.5-53	125	98.33	13.25	\$637	\$663	N/A	\$68
Z18S5SHN	16 x 18 x 52.5-53	125	88.78	11.50	\$611	\$638	N/A	\$57
Z16S5SHN	16 x 16 x 52.5-53	125	82.76	10.50	\$570	\$596	N/A	\$57
Z15S5SHN	16 x 15 x 52.5-53	100	78.18	9.75	\$562	\$582	N/A	\$57
Z12S5SHN	16 x 12 x 52.5-53	100	69.69	8.25	\$519	\$537	N/A	\$46

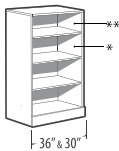

* Accepts collator 11\"/>

Open Storage Cabinet*

Includes three 3-position fixed/height adjustable shelves

Required Specifications

- Top finish
- Top/edge detail
- Handles
- Base finish

Optional Specifications

- HP laminate
- Collator*
- Glazed doors**

STORAGE MODULES - 52.5" / 53" HIGH

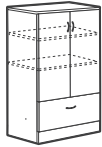

Glazed door option

File Module with Doors**

MODEL#	DIMENSIONS D x W x H	FREIGHT CLASS	WT./LBS.	CUBIC FT.	1" TOP	1.5" TOP	GLAZE ADD	HP ADD
Z36L5F	24 x 36 x 52.5-53	125	247.80	31.25	\$1627	\$1681	\$718	\$135
Z30L5F	24 x 30 x 52.5-53	100	216.30	27	\$1528	\$1574	\$627	\$113
Z36M5F	20 x 36 x 52.5-53	100	221.55	27	\$1532	\$1578	\$718	\$135
Z30M5F	20 x 30 x 52.5-53	100	204.75	22.75	\$1400	\$1439	\$627	\$113
Z36S5F	16 x 36 x 52.5-53	100	189	21.75	\$1389	\$1435	\$718	\$101
Z30S5F	16 x 30 x 52.5-53	100	163.80	18.50	\$1235	\$1266	\$627	\$91

One lateral file drawer. Laminate doors are standard. **Includes two 3-position fixed/height adjustable shelves.** Upper lock secures storage compartment. Lower lock secures one file drawer. Front-to-back and side-to-side letter/legal filing capability. Side-to-side file bars included.

- Lateral file drawer construction is for accommodating hanging files NOT for stacking materials on the drawer bottom.

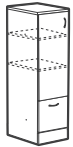

Glazed door option

File Module with Door - LEFT**

Z16L5FL	24 x 16 x 52.5-53	100	140.70	15.50	\$1005	\$1037	\$368	\$68
Z15L5FL	24 x 15 x 52.5-53	100	134.40	14.25	\$964	\$990	\$322	\$68
Z16M5FL	20 x 16 x 52.5-53	100	123.90	13	\$926	\$953	\$348	\$68
Z15M5FL	20 x 15 x 52.5-53	100	119.70	12.25	\$886	\$907	\$322	\$68
Z16S5FL	16 x 16 x 52.5-53	92.5	105	10.50	\$845	\$871	\$348	\$57
Z15S5FL	16 x 15 x 52.5-53	92.5	99.75	9.75	\$825	\$846	\$322	\$57

One file drawer. Laminate door is standard. **Includes two 3-position fixed/height adjustable shelves.** Upper lock secures storage compartment. Lower lock secures one file drawer.

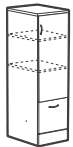

Glazed door option

File Module with Door - RIGHT**

Z16L5FR	24 x 16 x 52.5-53	100	140.70	15.50	\$1005	\$1037	\$368	\$68
Z15L5FR	24 x 15 x 52.5-53	100	134.40	14.25	\$964	\$990	\$322	\$68
Z16M5FR	20 x 16 x 52.5-53	100	123.90	13	\$926	\$953	\$348	\$68
Z15M5FR	20 x 15 x 52.5-53	100	119.70	12.25	\$886	\$907	\$322	\$68
Z16S5FR	16 x 16 x 52.5-53	92.5	105	10.50	\$845	\$871	\$348	\$57
Z15S5FR	16 x 15 x 52.5-53	92.5	99.75	9.75	\$825	\$846	\$322	\$57

One file drawer. Laminate door is standard. **Includes two 3-position fixed/height adjustable shelves.** Upper lock secures storage compartment. Lower lock secures one file drawer.

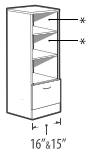
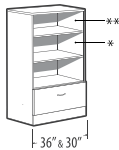

* Accepts collator 11" high
** Accepts collator 11.3" high

File Module with Open Shelves*

Z36L5FN	24 x 36 x 52.5-53	125	224.32	31.25	\$1377	\$1431	N/A	\$135
Z30L5FN	24 x 30 x 52.5-53	125	196.91	27	\$1314	\$1360	N/A	\$113
Z16L5FN	24 x 16 x 52.5-53	100	130.15	15.50	\$884	\$915	N/A	\$68
Z15L5FN	24 x 15 x 52.5-53	100	125.23	14.25	\$854	\$880	N/A	\$68
Z36M5FN	20 x 36 x 52.5-53	125	197.05	27	\$1283	\$1329	N/A	\$135
Z30M5FN	20 x 30 x 52.5-53	125	174.19	22.75	\$1187	\$1225	N/A	\$113
Z16M5FN	20 x 16 x 52.5-53	100	113.48	13	\$804	\$831	N/A	\$68
Z15M5FN	20 x 15 x 52.5-53	100	109.67	12.25	\$775	\$796	N/A	\$68
Z36S5FN	16 x 36 x 52.5-53	125	166.64	21.75	\$1139	\$1185	N/A	\$101
Z30S5FN	16 x 30 x 52.5-53	125	145.17	18.50	\$1021	\$1052	N/A	\$91
Z16S5FN	16 x 16 x 52.5-53	100	94.71	10.50	\$723	\$749	N/A	\$57
Z15S5FN	16 x 15 x 52.5-53	100	89.91	9.75	\$714	\$735	N/A	\$57

Three open shelves and one file drawer on bottom. **Includes two 3-position fixed/height adjustable shelves.** Lock secures file drawer. 36" and 30" wide models have front-to-back and side-to-side letter/legal filing capability. Side-to-side file bars included

- Lateral file drawer construction is for accommodating hanging files NOT for stacking materials on the drawer bottom.

Required Specifications

- Top finish
- Top/edge detail
- Handles
- Base finish

Optional Specifications

- HP laminate
- Collator*
- Glazed doors**
- Box drawer - no upcharge*

STORAGE MODULES - 52.5" / 53" HIGH

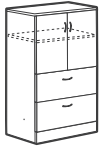

Glazed door option

Two File Module with Doors

MODEL#	DIMENSIONS D x W x H	FREIGHT CLASS	WT/LBS.	CUBIC FT.	1" TOP	1.5" TOP	GLAZE ADD	HP ADD
Z36L5E	24 x 36 x 52.5-53	100	250.95	31.25	\$1844	\$1898	\$538	\$135
Z30L5E	24 x 30 x 52.5-53	100	222.60	27	\$1719	\$1765	\$472	\$113
Z36M5E	20 x 36 x 52.5-53	100	229.95	27	\$1759	\$1806	\$560	\$135
Z30M5E	20 x 30 x 52.5-53	100	201.60	22.75	\$1601	\$1640	\$494	\$113
Z36S5E	16 x 36 x 52.5-53	100	193.20	21.75	\$1552	\$1597	\$560	\$101
Z30S5E	16 x 30 x 52.5-53	100	170.10	18.50	\$1427	\$1458	\$494	\$91

Two lateral file drawers on bottom. Laminate doors are standard. **Includes one 3-position fixed/height adjustable shelf.** Upper lock secures storage compartment. Lower lock secures two file drawers. Front-to-back and side-to-side letter/legal filing capability. Side-to-side file bars included.

- Lateral file drawer construction is for accommodating hanging files NOT for stacking materials on the drawer bottom.

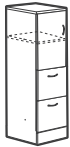

Glazed door option

Two File Module with Door - LEFT

Z16L5EL	24 x 16 x 52.5-53	100	144.90	15.50	\$1070	\$1101	\$272	\$68
Z15L5EL	24 x 15 x 52.5-53	100	139.65	14.25	\$1031	\$1057	\$244	\$68
Z16M5EL	20 x 16 x 52.5-53	92.5	130.20	13	\$995	\$1022	\$271	\$68
Z15M5EL	20 x 15 x 52.5-53	92.5	126	12.25	\$956	\$979	\$244	\$68
Z16S5EL	16 x 16 x 52.5-53	92.5	109.20	10.50	\$912	\$938	\$271	\$57
Z15S5EL	16 x 15 x 52.5-53	92.5	105	9.75	\$896	\$917	\$244	\$57

Two file drawers on bottom. Laminate door is standard. **Includes one 3-position fixed/height adjustable shelf.** Upper lock secures storage compartment. Lower lock secures two file drawers.

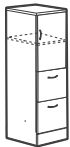

Glazed door option

Two File Module with Door - RIGHT

Z16L5ER	24 x 16 x 52.5-53	100	144.90	15.50	\$1070	\$1101	\$272	\$68
Z15L5ER	24 x 15 x 52.5-53	100	139.65	14.25	\$1031	\$1057	\$244	\$68
Z16M5ER	20 x 16 x 52.5-53	92.5	130.20	13	\$995	\$1022	\$271	\$68
Z15M5ER	20 x 15 x 52.5-53	92.5	126	12.25	\$956	\$979	\$244	\$68
Z16S5ER	16 x 16 x 52.5-53	92.5	109.20	10.50	\$912	\$938	\$271	\$57
Z15S5ER	16 x 15 x 52.5-53	92.5	105	9.75	\$896	\$917	\$244	\$57

Two file drawers on bottom. Laminate door is standard. **Includes one 3-position fixed/height adjustable shelf.** Upper lock secures storage compartment. Lower lock secures two file drawers.

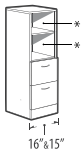
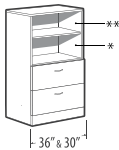

* Accepts collator 11" high
** Accepts collator 11.3" high

Two File Module with Open Shelves

Z36L5EN	24 x 36 x 52.5-53	125	235.45	31.25	\$1646	\$1700	N/A	\$135
Z30L5EN	24 x 30 x 52.5-53	125	209.86	27	\$1541	\$1586	N/A	\$113
Z16L5EN	24 x 16 x 52.5-53	100	137.89	15.50	\$970	\$1001	N/A	\$68
Z15L5EN	24 x 15 x 52.5-53	100	133.80	14.25	\$939	\$965	N/A	\$68
Z36M5EN	20 x 36 x 52.5-53	125	213.43	27	\$1563	\$1609	N/A	\$135
Z30M5EN	20 x 30 x 52.5-53	100	188.19	22.75	\$1422	\$1461	N/A	\$113
Z16M5EN	20 x 16 x 52.5-53	100	123.33	13	\$894	\$921	N/A	\$68
Z15M5EN	20 x 15 x 52.5-53	100	119.29	12.25	\$864	\$885	N/A	\$68
Z36S5EN	16 x 36 x 52.5-53	100	178.82	21.75	\$1354	\$1399	N/A	\$101
Z30S5EN	16 x 30 x 52.5-53	100	158.12	18.50	\$1248	\$1279	N/A	\$91
Z16S5EN	16 x 16 x 52.5-53	100	102.46	10.50	\$811	\$837	N/A	\$57
Z15S5EN	16 x 15 x 52.5-53	92.5	98.48	9.75	\$805	\$825	N/A	\$57

Two open shelves and two file drawers on bottom. **Includes one 3-position fixed/height adjustable shelf.** Lock secures all drawers. 36" and 30" wide models have front-to-back and side-to-side letter/legal filing capability. Side-to-side file bars included.

- Lateral file drawer construction is for accommodating hanging files NOT for stacking materials on the drawer bottom.

Required Specifications

Top finish
Top/edge detail
Handles
Base finish

Optional Specifications

HP laminate
Collator*
Glazed doors**
Box drawer - no upcharge*

STORAGE MODULES - 52.5" / 53" HIGH

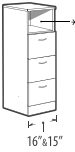
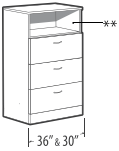

Three File Module with Open Shelf*

MODEL#	DIMENSIONS D x W x H	FREIGHT CLASS	WT/LBS.	CUBIC FT.	1" TOP	1.5" TOP	GLAZE ADD	HP ADD
Z36L53FN	24 x 36 x 52.5-53	125	247.80	31.25	\$1866	\$1920	N/A	\$135
Z30L53FN	24 x 30 x 52.5-53	100	221.55	27	\$1767	\$1813	N/A	\$113
Z16L53FN	24 x 16 x 52.5-53	100	147	15.50	\$1098	\$1129	N/A	\$68
Z15L53FN	24 x 15 x 52.5-53	100	140.70	14.25	\$1066	\$1092	N/A	\$68
Z36M53FN	20 x 36 x 52.5-53	100	227.85	27	\$1793	\$1839	N/A	\$135
Z30M53FN	20 x 30 x 52.5-53	100	203.70	22.75	\$1657	\$1695	N/A	\$113
Z16M53FN	20 x 16 x 52.5-53	92.5	132.30	13	\$1026	\$1053	N/A	\$68
Z15M53FN	20 x 15 x 52.5-53	92.5	128.10	12.25	\$996	\$1017	N/A	\$68
Z36S53FN	16 x 36 x 52.5-53	100	190.05	21.75	\$1588	\$1633	N/A	\$101
Z30S53FN	16 x 30 x 52.5-53	100	166.95	18.50	\$1446	\$1477	N/A	\$91
Z16S53FN	16 x 16 x 52.5-53	92.5	112.35	10.50	\$941	\$967	N/A	\$57
Z15S53FN	16 x 15 x 52.5-53	92.5	107.10	9.75	\$932	\$952	N/A	\$57

Fixed open shelf and three file drawers. Lock secures all drawers. 36" and 30" wide models have front-to-back and side-to-side letter/legal filing capability. Side-to-side file bars included.

- Lateral file drawer construction is for accommodating hanging files NOT for stacking materials on the drawer bottom.



Four File Module

Z36L54F	24 x 36 x 52.5-53	100	256.20	31.25	\$2079	\$2132	N/A	\$135
Z30L54F	24 x 30 x 52.5-53	100	234.15	27	\$1994	\$2040	N/A	\$113
Z16L54F	24 x 16 x 52.5-53	92.5	155.40	15.50	\$1193	\$1224	N/A	\$68
Z15L54F	24 x 15 x 52.5-53	92.5	148.05	14.25	\$1152	\$1178	N/A	\$68
Z36M54F	20 x 36 x 52.5-53	100	239.40	27	\$2015	\$2061	N/A	\$135
Z30M54F	20 x 30 x 52.5-53	100	218.40	22.75	\$1893	\$1932	N/A	\$113
Z16M54F	20 x 16 x 52.5-53	92.5	141.75	13	\$1126	\$1153	N/A	\$68
Z15M54F	20 x 15 x 52.5-53	92.5	136.50	12.25	\$1087	\$1108	N/A	\$68
Z36S54F	16 x 36 x 52.5-53	100	205	21.75	\$1802	\$1847	N/A	\$101
Z30S54F	16 x 30 x 52.5-53	100	180	18.50	\$1643	\$1674	N/A	\$91
Z16S54F	16 x 16 x 52.5-53	92.5	122	10.50	\$1106	\$1132	N/A	\$57
Z15S54F	16 x 15 x 52.5-53	92.5	116	9.75	\$1066	\$1087	N/A	\$57

Four file drawers. Lock secures all drawers. 36" and 30" wide models have front-to-back and side-to-side letter/legal filing capability. Side-to-side file bars included.

- Lateral file drawer construction is for accommodating hanging files NOT for stacking materials on the drawer bottom.



Four File Module

Z36L5S4F	24 x 36 x 52.5-53	100	286	31.25	\$2487	\$2540	N/A	\$135
Z36M5S4F	20 x 36 x 52.5-53	100	269	27	\$2413	\$2460	N/A	\$135

Four file drawers with steel drawer interior. Lock secures all drawers. Front-to-back and side-to-side letter/legal filing capability. Side-to-side file bars included.

- Front-to-back filing bars available separately. Order **FBB** bars. See "FBB" on page 699.
- Lateral file drawer construction is for accommodating hanging files NOT for stacking materials on the drawer bottom.

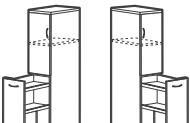

LEFT RIGHT Vertical Utility Drawer with Door**

Z12L5VDL	24 x 12 x 52.5-53	92.5	137.55	11.75	\$948	\$971	\$221	\$46
Z12M5VDL	20 x 12 x 52.5-53	92.5	118.65	10	\$852	\$870	\$221	\$46
Z12S5VDL	16 x 12 x 52.5-53	85	100	8.25	\$769	\$787	\$221	\$46
Z12L5VDR	24 x 12 x 52.5-53	92.5	137.55	11.75	\$948	\$971	\$221	\$46
Z12M5VDR	20 x 12 x 52.5-53	92.5	118.65	10	\$852	\$870	\$221	\$46
Z12S5VDR	16 x 12 x 52.5-53	85	100	8.25	\$769	\$787	\$221	\$46

Specify **VDL** models for **LEFT** or **VDR** models for **RIGHT**

Laminate doors are standard. **Includes one 3-position fixed/height adjustable shelf** and one vertical drawer. Upper lock secures storage compartment. Lower lock secures vertical drawer.

Required Specifications

- Top finish
- Top/edge detail
- Handles
- Base finish

Optional Specifications

- HP laminate
- Collator*
- Glazed doors**
- Box drawer - no upcharge*

STORAGE MODULES - 65" / 65.5" HIGH

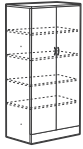

Glazed door option

Storage Cabinet with Doors**

MODEL#	DIMENSIONS	FREIGHT CLASS	WT/LBS.	CUBIC FT.	1" TOP	1.5" TOP	GLAZE ADD	HP ADD	
D x W x H									
Z36L6SH	24 x 36 x 65-65.5	125	273	39	\$1610	\$1664	\$1044	N/A	
Z30L6SH	24 x 30 x 65-65.5	125	238.35	32.75	\$1406	\$1452	\$903	N/A	
Z36M6SH	20 x 36 x 65-65.5	125	246.75	33.25	\$1493	\$1540	\$1044	N/A	
Z30M6SH	20 x 30 x 65-65.5	125	212.10	27.75	\$1302	\$1340	\$903	N/A	
Z36S6SH	16 x 36 x 65-65.5	125	210	26.50	\$1352	\$1397	\$1044	N/A	
Z30S6SH	16 x 30 x 65-65.5	100	183.75	22.50	\$1162	\$1194	\$903	N/A	

Laminate doors are standard. **Includes four 3-position fixed/height adjustable shelves.** Standard with lock.

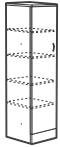

Glazed door option

Storage Cabinet with Door - LEFT**

Z21L6SHL	24 x 21 x 65-65.5	125	185.85	23.50	\$1153	\$1190	\$578	N/A
Z18L6SHL	24 x 18 x 65-65.5	100	168	20.50	\$1077	\$1109	\$519	N/A
Z16L6SHL	24 x 16 x 65-65.5	100	156.45	18.75	\$1014	\$1045	\$514	N/A
Z15L6SHL	24 x 15 x 65-65.5	100	149.10	17.50	\$984	\$1010	\$449	N/A
Z12L6SHL	24 x 12 x 65-65.5	100	133.35	14.50	\$893	\$916	\$403	N/A
Z21M6SHL	20 x 21 x 65-65.5	100	170.10	20	\$1032	\$1064	\$578	N/A
Z18M6SHL	20 x 18 x 65-65.5	100	148.05	17.25	\$984	\$1011	\$519	N/A
Z16M6SHL	20 x 16 x 65-65.5	100	137.55	15.75	\$926	\$953	\$514	N/A
Z15M6SHL	20 x 15 x 65-65.5	100	133.35	14.75	\$882	\$905	\$449	N/A
Z12M6SHL	20 x 12 x 65-65.5	100	116.55	12.25	\$817	\$836	\$403	N/A
Z21S6SHL	16 x 21 x 65-65.5	100	140.70	16	\$951	\$976	\$578	N/A
Z18S6SHL	16 x 18 x 65-65.5	100	126	14	\$880	\$906	\$519	N/A
Z16S6SHL	16 x 16 x 65-65.5	100	116.55	13	\$828	\$854	\$514	N/A
Z15S6SHL	16 x 15 x 65-65.5	100	111.30	12	\$786	\$807	\$449	N/A
Z12S6SHL	16 x 12 x 65-65.5	100	96.60	10	\$721	\$739	\$403	N/A

Laminate doors are standard. **Includes four 3-position fixed/height adjustable shelves.** Standard with lock.

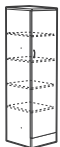

Glazed door option

Storage Cabinet with Door - RIGHT**

Z21L6SHR	24 x 21 x 65-65.5	125	185.85	23.50	\$1153	\$1190	\$578	N/A
Z18L6SHR	24 x 18 x 65-65.5	100	168	20.50	\$1077	\$1109	\$519	N/A
Z16L6SHR	24 x 16 x 65-65.5	100	156.45	18.75	\$1014	\$1045	\$514	N/A
Z15L6SHR	24 x 15 x 65-65.5	100	149.10	17.50	\$984	\$1010	\$449	N/A
Z12L6SHR	24 x 12 x 65-65.5	100	133.35	14.50	\$893	\$916	\$403	N/A
Z21M6SHR	20 x 21 x 65-65.5	100	170.10	20	\$1032	\$1064	\$578	N/A
Z18M6SHR	20 x 18 x 65-65.5	100	148.05	17.25	\$984	\$1011	\$519	N/A
Z16M6SHR	20 x 16 x 65-65.5	100	137.55	15.75	\$926	\$953	\$514	N/A
Z15M6SHR	20 x 15 x 65-65.5	100	133.35	14.75	\$882	\$905	\$449	N/A
Z12M6SHR	20 x 12 x 65-65.5	100	116.55	12.25	\$817	\$836	\$403	N/A
Z21S6SHR	16 x 21 x 65-65.5	100	140.70	16	\$951	\$976	\$578	N/A
Z18S6SHR	16 x 18 x 65-65.5	100	126	14	\$880	\$906	\$519	N/A
Z16S6SHR	16 x 16 x 65-65.5	100	116.55	13	\$828	\$854	\$514	N/A
Z15S6SHR	16 x 15 x 65-65.5	100	111.30	12	\$786	\$807	\$449	N/A
Z12S6SHR	16 x 12 x 65-65.5	100	96.60	10	\$721	\$739	\$403	N/A

Laminate doors are standard. **Includes four 3-position fixed/height adjustable shelves.** Standard with lock.

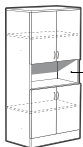

* Accepts collator 11" high

Storage Cabinet with Doors and Cavity*

Z36L6SHC	24 x 36 x 65-65.5	125	266.90	39	\$1658	\$1711	\$1195	N/A
Z30L6SHC	24 x 30 x 65-65.5	125	232.57	32.75	\$1478	\$1524	\$1047	N/A
Z36M6SHC	20 x 36 x 65-65.5	125	238.59	33.25	\$1541	\$1587	\$1195	N/A
Z30M6SHC	20 x 30 x 65-65.5	125	205.65	27.75	\$1374	\$1412	\$1047	N/A
Z36S6SHC	16 x 36 x 65-65.5	125	205.02	26.50	\$1400	\$1445	\$1195	N/A
Z30S6SHC	16 x 30 x 65-65.5	125	178.73	22.50	\$1233	\$1264	\$1047	N/A

Laminate doors are standard. **Includes two 3-position fixed/height adjustable shelves.** Upper and lower locks secure both compartments.

Required Specifications

Top finish
Top/edge detail
Handles
Base finish

Optional Specifications

Collator*
Glazed doors**

STORAGE MODULES - 65" / 65.5" HIGH

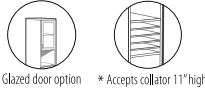
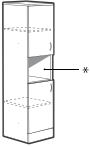

Storage Cabinet with Doors and Cavity - LEFT*

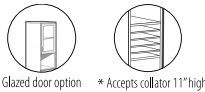
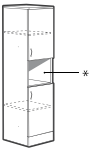

Storage Cabinet with Doors and Cavity - RIGHT*

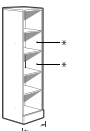
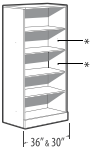

Open Storage Cabinet

MODEL#	DIMENSIONS D x W x H	FREIGHT CLASS	WT./LBS.	CUBIC FT.	1" TOP	1.5" TOP	GLAZE ADD	HP ADD
Z21L6SHCL	24 x 21 x 65-65.5	125	182.12	23.50	\$1180	\$1216	\$657	N/A
Z18L6SHCL	24 x 18 x 65-65.5	100	164.95	20.50	\$1105	\$1137	\$593	N/A
Z16L6SHCL	24 x 16 x 65-65.5	100	154.21	18.75	\$1039	\$1070	\$583	N/A
Z15L6SHCL	24 x 15 x 65-65.5	100	147.78	17.50	\$1015	\$1041	\$519	N/A
Z12L6SHCL	24 x 12 x 65-65.5	100	130.62	14.50	\$928	\$951	\$468	N/A
Z21M6SHCL	20 x 21 x 65-65.5	100	165.16	20	\$1058	\$1090	\$657	N/A
Z18M6SHCL	20 x 18 x 65-65.5	100	143.97	17.25	\$1012	\$1040	\$593	N/A
Z16M6SHCL	20 x 16 x 65-65.5	100	134.39	15.75	\$952	\$979	\$583	N/A
Z15M6SHCL	20 x 15 x 65-65.5	100	130.12	14.75	\$913	\$936	\$519	N/A
Z12M6SHCL	20 x 12 x 65-65.5	100	113.13	12.25	\$852	\$871	\$468	N/A
Z21S6SHCL	16 x 21 x 65-65.5	100	136.66	16	\$1000	\$1026	\$657	N/A
Z18S6SHCL	16 x 18 x 65-65.5	100	121.94	14	\$908	\$935	\$593	N/A
Z16S6SHCL	16 x 16 x 65-65.5	100	113.52	13	\$855	\$881	\$583	N/A
Z15S6SHCL	16 x 15 x 65-65.5	100	108.26	12	\$816	\$837	\$519	N/A
Z12S6SHCL	16 x 12 x 65-65.5	100	94.59	10	\$756	\$773	\$468	N/A

Laminate doors are standard. **Includes two 3-position fixed/height adjustable shelves.** Upper and lower locks secure both compartments.

Z21L6SHCR	24 x 21 x 65-65.5	125	182.12	23.50	\$1180	\$1216	\$657	N/A
Z18L6SHCR	24 x 18 x 65-65.5	100	164.95	20.50	\$1105	\$1137	\$593	N/A
Z16L6SHCR	24 x 16 x 65-65.5	100	154.21	18.75	\$1039	\$1070	\$583	N/A
Z15L6SHCR	24 x 15 x 65-65.5	100	147.78	17.50	\$1015	\$1041	\$519	N/A
Z12L6SHCR	24 x 12 x 65-65.5	100	130.62	14.50	\$928	\$951	\$468	N/A
Z21M6SHCR	20 x 21 x 65-65.5	100	165.16	20	\$1058	\$1090	\$657	N/A
Z18M6SHCR	20 x 18 x 65-65.5	100	143.97	17.25	\$1012	\$1040	\$593	N/A
Z16M6SHCR	20 x 16 x 65-65.5	100	134.39	15.75	\$952	\$979	\$583	N/A
Z15M6SHCR	20 x 15 x 65-65.5	100	130.12	14.75	\$913	\$936	\$519	N/A
Z12M6SHCR	20 x 12 x 65-65.5	100	113.13	12.25	\$852	\$871	\$468	N/A
Z21S6SHCR	16 x 21 x 65-65.5	100	136.66	16	\$1000	\$1026	\$657	N/A
Z18S6SHCR	16 x 18 x 65-65.5	100	121.94	14	\$908	\$935	\$593	N/A
Z16S6SHCR	16 x 16 x 65-65.5	100	113.52	13	\$855	\$881	\$583	N/A
Z15S6SHCR	16 x 15 x 65-65.5	100	108.26	12	\$816	\$837	\$519	N/A
Z12S6SHCR	16 x 12 x 65-65.5	100	94.59	10	\$756	\$773	\$468	N/A

Laminate doors are standard. **Includes two 3-position fixed/height adjustable shelves.** Upper and lower locks secure both compartments.

Z36L6SHN	24 x 36 x 65-65.5	125	234.42	39	\$1247	\$1301	N/A	N/A
Z30L6SHN	24 x 30 x 65-65.5	125	205.50	32.75	\$1104	\$1150	N/A	N/A
Z21L6SHN	24 x 21 x 65-65.5	125	163.17	23.50	\$959	\$996	N/A	N/A
Z18L6SHN	24 x 18 x 65-65.5	125	148.71	20.50	\$900	\$932	N/A	N/A
Z16L6SHN	24 x 16 x 65-65.5	125	139.77	18.75	\$838	\$869	N/A	N/A
Z15L6SHN	24 x 15 x 65-65.5	125	134.25	17.50	\$829	\$855	N/A	N/A
Z12L6SHN	24 x 12 x 65-65.5	100	119.79	14.50	\$752	\$773	N/A	N/A
Z36M6SHN	20 x 36 x 65-65.5	125	206.11	33.25	\$1129	\$1175	N/A	N/A
Z30M6SHN	20 x 30 x 65-65.5	125	178.58	27.75	\$999	\$1037	N/A	N/A
Z21M6SHN	20 x 21 x 65-65.5	125	146.22	20	\$838	\$870	N/A	N/A
Z18M6SHN	20 x 18 x 65-65.5	125	127.73	17.25	\$808	\$836	N/A	N/A
Z16M6SHN	20 x 16 x 65-65.5	125	119.95	15.75	\$750	\$777	N/A	N/A
Z15M6SHN	20 x 15 x 65-65.5	125	116.59	14.75	\$728	\$751	N/A	N/A
Z12M6SHN	20 x 12 x 65-65.5	100	102.30	12.25	\$677	\$695	N/A	N/A
Z36S6SHN	16 x 36 x 65-65.5	125	172.54	26.50	\$989	\$1034	N/A	N/A
Z30S6SHN	16 x 30 x 65-65.5	125	151.66	22.50	\$858	\$890	N/A	N/A
Z21S6SHN	16 x 21 x 65-65.5	125	117.71	16	\$755	\$781	N/A	N/A
Z18S6SHN	16 x 18 x 65-65.5	125	105.70	14	\$704	\$730	N/A	N/A
Z16S6SHN	16 x 16 x 65-65.5	125	99.09	13	\$654	\$680	N/A	N/A
Z15S6SHN	16 x 15 x 65-65.5	125	94.73	12	\$632	\$653	N/A	N/A
Z12S6SHN	16 x 12 x 65-65.5	100	83.76	10	\$581	\$599	N/A	N/A

Includes four 3-position fixed/height adjustable shelves.

Required Specifications

- Top finish
- Top/edge detail
- Handles
- Base finish

Optional Specifications

- Collator
- Glazed doors*

STORAGE MODULES - 65" / 65.5" HIGH

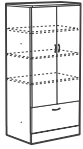

Glazed door option

File Module with Doors*

MODEL#	DIMENSIONS	FREIGHT CLASS	WT/LBS.	CUBIC FT.	1" TOP	1.5" TOP	GLAZE ADD	HP ADD
D x W x H								
Z36L6F	24 x 36 x 65-65.5	125	290.85	39	\$1858	\$1911	\$889	N/A
Z30L6F	24 x 30 x 65-65.5	125	255.15	32.75	\$1683	\$1729	\$773	N/A
Z36M6F	20 x 36 x 65-65.5	100	266.70	33.25	\$1776	\$1822	\$889	N/A
Z30M6F	20 x 30 x 65-65.5	100	228.90	27.75	\$1565	\$1603	\$773	N/A
Z36S6F	16 x 36 x 65-65.5	100	219.45	26.50	\$1564	\$1609	\$889	N/A
Z30S6F	16 x 30 x 65-65.5	100	192.15	22.50	\$1405	\$1436	\$773	N/A

One lateral file drawer. Laminate doors are standard. **Includes three 3-position fixed/height adjustable shelves.** Upper lock secures storage compartment. Lower lock secures one file drawer. Front-to-back and side-to-side letter/legal filing capability. Side-to-side file bars included.

- Lateral file drawer construction is for accommodating hanging files NOT for stacking materials on the drawer bottom.



Glazed door option

File Module with Door - LEFT*

Z16L6FL	24 x 16 x 65-65.5	100	165.90	18.75	\$1137	\$1169	\$889	N/A
Z15L6FL	24 x 15 x 65-65.5	100	159.60	17.50	\$1107	\$1133	\$773	N/A
Z16M6FL	20 x 16 x 65-65.5	100	147	15.75	\$1050	\$1077	\$436	N/A
Z15M6FL	20 x 15 x 65-65.5	100	141.75	14.75	\$1005	\$1028	\$384	N/A
Z16S6FL	16 x 16 x 65-65.5	100	124.95	13	\$950	\$976	\$436	N/A
Z15S6FL	16 x 15 x 65-65.5	100	119.70	12	\$913	\$934	\$384	N/A

One file drawer. Laminate door is standard. **Includes three 3-position fixed/height adjustable shelves.** Upper lock secures storage compartment. Lower lock secures one file drawer.



Glazed door option

File Module with Door - RIGHT*

Z16L6FR	24 x 16 x 65-65.5	100	165.90	18.75	\$1137	\$1169	\$889	N/A
Z15L6FR	24 x 15 x 65-65.5	100	159.60	17.50	\$1107	\$1133	\$773	N/A
Z16M6FR	20 x 16 x 65-65.5	100	147	15.75	\$1050	\$1077	\$436	N/A
Z15M6FR	20 x 15 x 65-65.5	100	141.75	14.75	\$1005	\$1028	\$384	N/A
Z16S6FR	16 x 16 x 65-65.5	100	124.95	13	\$950	\$976	\$436	N/A
Z15S6FR	16 x 15 x 65-65.5	100	119.70	12	\$913	\$934	\$384	N/A

One file drawer. Laminate door is standard. **Includes three 3-position fixed/height adjustable shelves.** Upper lock secures storage compartment. Lower lock secures one file drawer.

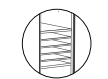
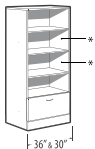

* Accepts collator 11" high

File Module with Open Shelves**

Z36L6FN	24 x 36 x 65-65.5	125	260.25	39	\$1539	\$1592	N/A	N/A
Z30L6FN	24 x 30 x 65-65.5	125	228.95	32.75	\$1398	\$1444	N/A	N/A
Z16L6FN	24 x 16 x 65-65.5	100	152.77	18.75	\$984	\$1015	N/A	N/A
Z15L6FN	24 x 15 x 65-65.5	100	148.08	17.50	\$971	\$997	N/A	N/A
Z36M6FN	20 x 36 x 65-65.5	125	234.04	33.25	\$1457	\$1503	N/A	N/A
Z30M6FN	20 x 30 x 65-65.5	125	202.03	27.75	\$1280	\$1319	N/A	N/A
Z16M6FN	20 x 16 x 65-65.5	100	132.95	15.75	\$896	\$923	N/A	N/A
Z15M6FN	20 x 15 x 65-65.5	100	128.32	14.75	\$870	\$891	N/A	N/A
Z36S6FN	16 x 36 x 65-65.5	125	189.97	26.50	\$1245	\$1291	N/A	N/A
Z30S6FN	16 x 30 x 65-65.5	125	166.71	22.50	\$1122	\$1153	N/A	N/A
Z16S6FN	16 x 16 x 65-65.5	100	111.03	13	\$797	\$823	N/A	N/A
Z15S6FN	16 x 15 x 65-65.5	100	106.46	12	\$776	\$796	N/A	N/A

Four open shelves and one file drawer on bottom. **Includes three 3-position fixed/height adjustable shelves.** Lock secures file drawer. 36" and 30" wide models have front-to-back and side-to-side letter/legal filing capability. Side-to-side file bars included.

- Lateral file drawer construction is for accommodating hanging files NOT for stacking materials on the drawer bottom.

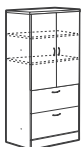

Glazed door option

Two File Module with Doors**

Z36L6E	24 x 36 x 65-65.5	125	294	39	\$2032	\$2086	\$722	N/A
Z30L6E	24 x 30 x 65-65.5	125	260.40	32.75	\$1857	\$1903	\$632	N/A
Z36M6E	20 x 36 x 65-65.5	100	269.85	33.25	\$1945	\$1991	\$722	N/A
Z30M6E	20 x 30 x 65-65.5	100	236.25	27.75	\$1759	\$1798	\$632	N/A
Z36S6E	16 x 36 x 65-65.5	100	225	26.50	\$1664	\$1710	\$722	N/A
Z30S6E	16 x 30 x 65-65.5	100	197	22.50	\$1592	\$1623	\$632	N/A

Two lateral file drawers on bottom. Laminate doors are standard. **Includes two 3-position fixed/height adjustable shelves.** Upper lock secures storage compartment. Lower lock secures two file drawers. Front-to-back and side-to-side letter/legal filing capability. Side-to-side file bars included.

- Lateral file drawer construction is for accommodating hanging files NOT for stacking materials on the drawer bottom.

Required Specifications

- Top finish
- Top/edge detail
- Handles
- Base finish

Optional Specifications

- Collator**
- Glazed doors*
- Box drawer - no upcharge

STORAGE MODULES - 65" / 65.5" HIGH

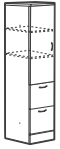

Glazed door option

Two File Module with Door - LEFT

MODEL#	DIMENSIONS D x W x H	FREIGHT CLASS	WT/LBS.	CUBIC FT.	1" TOP	1.5" TOP	GLAZE ADD	HP ADD
Z16L6EL	24 x 16 x 65-65.5	100	171.15	18.75	\$1202	\$1234	\$352	N/A
Z15L6EL	24 x 15 x 65-65.5	100	163.80	17.50	\$1174	\$1200	\$312	N/A
Z16M6EL	20 x 16 x 65-65.5	100	153.30	15.75	\$1118	\$1145	\$352	N/A
Z15M6EL	20 x 15 x 65-65.5	92.5	148.05	14.75	\$1077	\$1100	\$312	N/A
Z16S6EL	16 x 16 x 65-65.5	100	129.15	13	\$1021	\$1047	\$352	N/A
Z15S6EL	16 x 15 x 65-65.5	92.5	123.90	12	\$989	\$1010	\$312	N/A

Two file drawers on bottom. Laminate door is standard. **Includes two 3-position fixed/height adjustable shelves.** Upper lock secures storage compartment. Lower lock secures two file drawers.

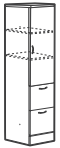

Glazed door option

Two File Module with Door - RIGHT

Z16L6ER	24 x 16 x 65-65.5	100	171.15	18.75	\$1202	\$1234	\$352	N/A
Z15L6ER	24 x 15 x 65-65.5	100	163.80	17.50	\$1174	\$1200	\$312	N/A
Z16M6ER	20 x 16 x 65-65.5	100	153.30	15.75	\$1118	\$1145	\$352	N/A
Z15M6ER	20 x 15 x 65-65.5	92.5	148.05	14.75	\$1077	\$1100	\$312	N/A
Z16S6ER	16 x 16 x 65-65.5	100	129.15	13	\$1021	\$1047	\$352	N/A
Z15S6ER	16 x 15 x 65-65.5	92.5	123.90	12	\$989	\$1010	\$312	N/A

Two file drawers on bottom. Laminate door is standard. **Includes three 3-position fixed/height adjustable shelves.** Upper lock secures storage compartment. Lower lock secures two file drawers.

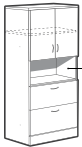

Glazed door option



* Accepts collator 11" high

Two File Module with Doors and Cavity*

Z36L6EC	24 x 36 x 65-65.5	125	287.90	39	\$1989	\$2042	\$637	N/A
Z30L6EC	24 x 30 x 65-65.5	125	254.62	32.75	\$1821	\$1867	\$554	N/A
Z36M6EC	20 x 36 x 65-65.5	125	261.69	33.25	\$1902	\$1948	\$637	N/A
Z30M6EC	20 x 30 x 65-65.5	100	229.80	27.75	\$1724	\$1763	\$554	N/A
Z36S6EC	16 x 36 x 65-65.5	100	218.67	26.50	\$1494	\$1539	\$637	N/A
Z30S6EC	16 x 30 x 65-65.5	100	191.33	22.50	\$1430	\$1461	\$554	N/A

Two lateral file drawers on bottom. Laminate doors are standard. **Includes one 3-position fixed/height adjustable shelf.** Upper lock secures storage compartment. Lower lock secures all drawers. Front-to-back and side-to-side letter/legal filing capability. Side-to-side file bars included.

- Lateral file drawer construction is for accommodating hanging files NOT for stacking materials on the drawer bottom.

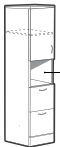

Glazed door option



* Accepts collator 11" high

Two File Module with Doors and Cavity - LEFT*

Z16L6ECL	24 x 16 x 65-65.5	100	168.91	18.75	\$1180	\$1212	\$312	N/A
Z15L6ECL	24 x 15 x 65-65.5	100	162.48	17.50	\$1158	\$1183	\$276	N/A
Z16M6ECL	20 x 16 x 65-65.5	100	150.14	15.75	\$1087	\$1114	\$312	N/A
Z15M6ECL	20 x 15 x 65-65.5	100	144.82	14.75	\$1050	\$1071	\$276	N/A
Z16S6ECL	16 x 16 x 65-65.5	100	126.12	13	\$999	\$1025	\$312	N/A
Z15S6ECL	16 x 15 x 65-65.5	92.5	120.86	12	\$971	\$991	\$276	N/A

Two file drawers on bottom. Laminate doors are standard. **Includes one 3-position fixed/height adjustable shelf.** Upper lock secures storage compartment. Lower lock secures all drawers.

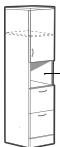

Glazed door option



* Accepts collator 11" high

Two File Module with Doors and Cavity - RIGHT*

Z16L6ECR	24 x 16 x 65-65.5	100	168.91	18.75	\$1180	\$1212	\$312	N/A
Z15L6ECR	24 x 15 x 65-65.5	100	162.48	17.50	\$1158	\$1183	\$276	N/A
Z16M6ECR	20 x 16 x 65-65.5	100	150.14	15.75	\$1087	\$1114	\$312	N/A
Z15M6ECR	20 x 15 x 65-65.5	100	144.82	14.75	\$1050	\$1071	\$276	N/A
Z16S6ECR	16 x 16 x 65-65.5	100	126.12	13	\$999	\$1025	\$312	N/A
Z15S6ECR	16 x 15 x 65-65.5	92.5	120.86	12	\$971	\$991	\$276	N/A

Two file drawers on bottom. Laminate doors are standard. **Includes one 3-position fixed/height adjustable shelf.** Upper lock secures storage compartment. Lower lock secures all drawers.

Required Specifications

Top finish
Top/edge detail
Handles
Base finish

Optional Specifications

Collator*
Glazed doors
Box drawer - no upcharge

STORAGE MODULES - 65" / 65.5" HIGH

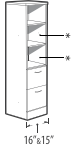
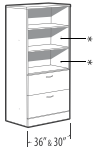

* Accepts collator 11" high

Two File Module with Open Shelves

MODEL#	DIMENSIONS D x W x H	FREIGHT CLASS	WT/LBS.	CUBIC FT.	1" TOP	1.5" TOP	GLAZE ADD	HP ADD
Z36L6EN	24 x 36 x 65-65.5	125	271.38	39	\$1774	\$1828	N/A	N/A
Z30L6EN	24 x 30 x 65-65.5	125	240.85	32.75	\$1626	\$1672	N/A	N/A
Z16L6EN	24 x 16 x 65-65.5	100	161.56	18.75	\$1079	\$1110	N/A	N/A
Z15L6EN	24 x 15 x 65-65.5	100	155.60	17.50	\$1064	\$1090	N/A	N/A
Z36M6EN	20 x 36 x 65-65.5	125	243.07	33.25	\$1687	\$1733	N/A	N/A
Z30M6EN	20 x 30 x 65-65.5	125	213.93	27.75	\$1528	\$1567	N/A	N/A
Z16M6EN	20 x 16 x 65-65.5	100	142.80	15.75	\$996	\$1023	N/A	N/A
Z15M6EN	20 x 15 x 65-65.5	100	137.94	14.75	\$966	\$989	N/A	N/A
Z36S6EN	16 x 36 x 65-65.5	125	202.15	26.50	\$1404	\$1450	N/A	N/A
Z30S6EN	16 x 30 x 65-65.5	125	177.56	22.50	\$1360	\$1391	N/A	N/A
Z16S6EN	16 x 16 x 65-65.5	100	118.78	13	\$897	\$923	N/A	N/A
Z15S6EN	16 x 15 x 65-65.5	100	113.98	12	\$878	\$899	N/A	N/A

Three open shelves and two file drawers on bottom. **Includes two 3-position fixed/height adjustable shelves.** Lock secures all drawers. 36" and 30" wide models have front-to-back and side-to-side letter/legal filing capability. Side-to-side file bars included.

- Lateral file drawer construction is for accommodating hanging files NOT for stacking materials on the drawer bottom.

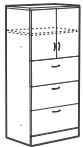

Glazed door option

Three File Module with Doors**

Z36L63F	24 x 36 x 65-65.5	125	297.15	39	\$2241	\$2295	\$637	N/A
Z30L63F	24 x 30 x 65-65.5	100	266.70	32.75	\$2084	\$2130	\$554	N/A
Z36M63F	20 x 36 x 65-65.5	100	275.10	33.25	\$2166	\$2212	\$637	N/A
Z30M63F	20 x 30 x 65-65.5	100	244.65	27.75	\$1988	\$2027	\$554	N/A
Z36S63F	16 x 36 x 65-65.5	100	233.10	26.50	\$1943	\$1988	\$637	N/A
Z30S63F	16 x 30 x 65-65.5	100	204.75	22.50	\$1770	\$1801	\$554	N/A

Three lateral file drawers on bottom. Laminate doors are standard. **Includes one 3-position fixed/height adjustable shelf.** Upper lock secures storage compartment. Lower lock secures three file drawers. Front-to-back and side-to-side letter/legal filing capability. Side-to-side file bars included.

- Lateral file drawer construction is for accommodating hanging files NOT for stacking materials on the drawer bottom.



Glazed door option

Three File Module with Door - LEFT**

Z16L63FL	24 x 16 x 65-65.5	100	176.40	18.75	\$1308	\$1339	\$312	N/A
Z15L63FL	24 x 15 x 65-65.5	100	169.05	17.50	\$1284	\$1310	\$276	N/A
Z16M63FL	20 x 16 x 65-65.5	92.5	159.60	15.75	\$1229	\$1256	\$312	N/A
Z15M63FL	20 x 15 x 65-65.5	92.5	153.30	14.75	\$1192	\$1213	\$276	N/A
Z16S63FL	16 x 16 x 65-65.5	92.5	134.40	13	\$1126	\$1152	\$312	N/A
Z15S63FL	16 x 15 x 65-65.5	92.5	129.15	12	\$1099	\$1120	\$276	N/A

Three file drawers on bottom. Laminate door is standard. **Includes one 3-position fixed/height adjustable shelf.** Upper lock secures storage compartment. Lower lock secures three file drawers.

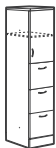

Glazed door option

Three File Module with Door - RIGHT**

Z16L63FR	24 x 16 x 65-65.5	100	176.40	18.75	\$1308	\$1339	\$312	N/A
Z15L63FR	24 x 15 x 65-65.5	100	169.05	17.50	\$1284	\$1310	\$276	N/A
Z16M63FR	20 x 16 x 65-65.5	92.5	159.60	15.75	\$1229	\$1256	\$312	N/A
Z15M63FR	20 x 15 x 65-65.5	92.5	153.30	14.75	\$1192	\$1213	\$276	N/A
Z16S63FR	16 x 16 x 65-65.5	92.5	134.40	13	\$1126	\$1152	\$312	N/A
Z15S63FR	16 x 15 x 65-65.5	92.5	129.15	12	\$1099	\$1120	\$276	N/A

Three file drawers on bottom. Laminate door is standard. **Includes one 3-position fixed/height adjustable shelf.** Upper lock secures storage compartment. Lower lock secures three file drawers.

Required Specifications

- Top finish
- Top/edge detail
- Handles
- Base finish

Optional Specifications

- Collator*
- Glazed doors**
- Box drawer - no upcharge

STORAGE MODULES - 65" / 65.5" HIGH

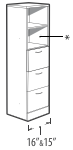
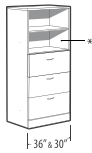

* Accepts collator 11" high

Three File Module with Open Shelves*

MODEL#	DIMENSIONS D x W x H	FREIGHT CLASS	WT./LBS.	CUBIC FT.	1" TOP	1.5" TOP	GLAZE ADD	HP ADD
Z36L63FN	24 x 36 x 65-65.5	125	282.51	39	\$2027	\$2080	N/A	N/A
Z30L63FN	24 x 30 x 65-65.5	125	253.80	32.75	\$1887	\$1933	N/A	N/A
Z16L63FN	24 x 16 x 65-65.5	100	170.36	18.75	\$1206	\$1237	N/A	N/A
Z15L63FN	24 x 15 x 65-65.5	100	164.18	17.50	\$1190	\$1216	N/A	N/A
Z36M63FN	20 x 36 x 65-65.5	125	258.40	33.25	\$1950	\$1996	N/A	N/A
Z30M63FN	20 x 30 x 65-65.5	100	231.08	27.75	\$1792	\$1831	N/A	N/A
Z16M63FN	20 x 16 x 65-65.5	100	152.64	15.75	\$1128	\$1155	N/A	N/A
Z15M63FN	20 x 15 x 65-65.5	100	146.52	14.75	\$1099	\$1120	N/A	N/A
Z36S63FN	16 x 36 x 65-65.5	100	219.59	26.50	\$1728	\$1774	N/A	N/A
Z30S63FN	16 x 30 x 65-65.5	100	192.61	22.50	\$1572	\$1603	N/A	N/A
Z16S63FN	16 x 16 x 65-65.5	100	127.58	13	\$1024	\$1050	N/A	N/A
Z15S63FN	16 x 15 x 65-65.5	92.5	122.56	12	\$1006	\$1026	N/A	N/A

Two open shelves and three file drawers on bottom. **Includes one 3-position fixed/height adjustable shelf.** Lock secures all drawers. 36" and 30" wide models have front-to-back and side-to-side letter/legal filing capability. Side-to-side file bars included.

- Lateral file drawer construction is for accommodating hanging files NOT for stacking materials on the drawer bottom.

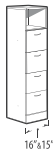
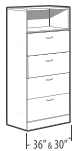

Four File Module with Open Shelf

Z36L64FN	24 x 36 x 65-65.5	125	300.30	39	\$2260	\$2314	N/A	N/A
Z30L64FN	24 x 30 x 65-65.5	100	271.95	32.75	\$2121	\$2167	N/A	N/A
Z16L64FN	24 x 16 x 65-65.5	100	180.60	18.75	\$1297	\$1329	N/A	N/A
Z15L64FN	24 x 15 x 65-65.5	100	174.30	17.50	\$1270	\$1296	N/A	N/A
Z36M64FN	20 x 36 x 65-65.5	100	271.95	33.25	\$2186	\$2233	N/A	N/A
Z30M64FN	20 x 30 x 65-65.5	100	245.70	27.75	\$2035	\$2073	N/A	N/A
Z16M64FN	20 x 16 x 65-65.5	92.5	161.70	15.75	\$1228	\$1255	N/A	N/A
Z15M64FN	20 x 15 x 65-65.5	92.5	155.40	14.75	\$1189	\$1210	N/A	N/A
Z36S64FN	16 x 36 x 65-65.5	100	228.90	26.50	\$1960	\$2005	N/A	N/A
Z30S64FN	16 x 30 x 65-65.5	100	202.65	22.50	\$1787	\$1818	N/A	N/A
Z16S64FN	16 x 16 x 65-65.5	92.5	134.40	13	\$1123	\$1149	N/A	N/A
Z15S64FN	16 x 15 x 65-65.5	92.5	130.20	12	\$1105	\$1126	N/A	N/A

Open shelf and four file drawers. Lock secures all drawers. 36" and 30" wide models have front-to-back and side-to-side letter/legal filing capability. Side-to-side file bars included.

- Lateral file drawer construction is for accommodating hanging files NOT for stacking materials on the drawer bottom.

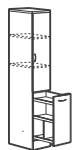
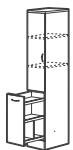

Glazed door option

LEFT RIGHT

Vertical Utility Drawer with Door**

Z12L6VDL	24 x 12 x 65-65.5	92.5	160.65	14.50	\$1045	\$1068	\$282	N/A
Z12M6VDL	20 x 12 x 65-65.5	92.5	139.65	12.25	\$952	\$971	\$282	N/A
Z12S6VDL	16 x 12 x 65-65.5	92.5	116.55	10	\$878	\$895	\$282	N/A
Z12L6VDR	24 x 12 x 65-65.5	92.5	160.65	14.50	\$1045	\$1068	\$282	N/A
Z12M6VDR	20 x 12 x 65-65.5	92.5	139.65	12.25	\$952	\$971	\$282	N/A
Z12S6VDR	16 x 12 x 65-65.5	92.5	116.55	10	\$878	\$895	\$282	N/A

Specify **VDL** models for **LEFT** or **VDR** models for **RIGHT**

Laminate doors are standard. **Includes two 3-position fixed/height adjustable shelves** and one vertical drawer. Upper lock secures storage compartment. Lower lock secures vertical drawer.

WARDROBE CABINETS - 65" / 65.5" HIGH

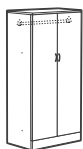

Wardrobe Cabinet

Z36L6WA	24 x 36 x 65-65.5	150	216.30	39	\$1379	\$1432	N/A	N/A
Z30L6WA	24 x 30 x 65-65.5	150	192.15	32.75	\$1241	\$1287	N/A	N/A
Z36M6WA	20 x 36 x 65-65.5	125	200.55	33.25	\$1321	\$1367	N/A	N/A
Z30M6WA	20 x 30 x 65-65.5	125	173.25	27.75	\$1168	\$1207	N/A	N/A

Laminate doors are standard. Full length hanging rod included. Standard with lock.

Required Specifications

- Top finish
- Top/edge detail
- Handles
- Base finish

Optional Specifications

- Collator*
- Glazed doors**
- Box drawer - no upcharge

STORAGE MODULES - 65" / 65.5" HIGH



Wardrobe Cabinet - LEFT

MODEL#	DIMENSIONS	FREIGHT CLASS	WT/LBS.	CUBIC FT.	1" TOP	1.5" TOP	GLAZE ADD	HP ADD
D x W x H								
Z24L6WAL	24 x 24 x 65-65.5	125	165.90	26.75	\$1137	\$1174	N/A	N/A
Z21L6WAL	24 x 21 x 65-65.5	125	152.25	23.50	\$1047	\$1083	N/A	N/A
Z18L6WAL	24 x 18 x 65-65.5	125	139.65	20.50	\$930	\$962	N/A	N/A
Z16L6WAL	24 x 16 x 65-65.5	125	132.30	18.75	\$909	\$941	N/A	N/A
Z15L6WAL	24 x 15 x 65-65.5	125	128.10	17.50	\$873	\$899	N/A	N/A
Z12L6WAL	24 x 12 x 65-65.5	125	115.50	14.50	\$806	\$827	N/A	N/A
Z24M6WAL	20 x 24 x 65-65.5	125	149.10	22.50	\$978	\$1010	N/A	N/A
Z21M6WAL	20 x 21 x 65-65.5	125	143.85	20	\$948	\$979	N/A	N/A
Z18M6WAL	20 x 18 x 65-65.5	125	124.95	17.25	\$859	\$886	N/A	N/A
Z16M6WAL	20 x 16 x 65-65.5	125	116.55	15.75	\$838	\$865	N/A	N/A
Z15M6WAL	20 x 15 x 65-65.5	125	113.40	14.75	\$787	\$810	N/A	N/A
Z12M6WAL	20 x 12 x 65-65.5	100	102.90	12.25	\$750	\$768	N/A	N/A

Laminate doors are standard. Full length hanging rod included. Standard with lock.

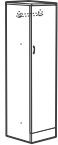

Wardrobe Cabinet - RIGHT

Z24L6WAR	24 x 24 x 65-65.5	125	165.90	26.75	\$1137	\$1174	N/A	N/A
Z21L6WAR	24 x 21 x 65-65.5	125	152.25	23.50	\$1047	\$1083	N/A	N/A
Z18L6WAR	24 x 18 x 65-65.5	125	139.65	20.50	\$930	\$962	N/A	N/A
Z16L6WAR	24 x 16 x 65-65.5	125	132.30	18.75	\$909	\$941	N/A	N/A
Z15L6WAR	24 x 15 x 65-65.5	125	128.10	17.50	\$873	\$899	N/A	N/A
Z12L6WAR	24 x 12 x 65-65.5	125	115.50	14.50	\$806	\$827	N/A	N/A
Z24M6WAR	20 x 24 x 65-65.5	125	149.10	22.50	\$978	\$1010	N/A	N/A
Z21M6WAR	20 x 21 x 65-65.5	125	143.85	20	\$948	\$979	N/A	N/A
Z18M6WAR	20 x 18 x 65-65.5	125	124.95	17.25	\$859	\$886	N/A	N/A
Z16M6WAR	20 x 16 x 65-65.5	125	116.55	15.75	\$838	\$865	N/A	N/A
Z15M6WAR	20 x 15 x 65-65.5	125	113.40	14.75	\$787	\$810	N/A	N/A
Z12M6WAR	20 x 12 x 65-65.5	100	102.90	12.25	\$750	\$768	N/A	N/A

Laminate doors are standard. Full length hanging rod included. Standard with lock.

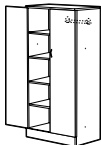

Wardrobe Cabinet/Shelving Combo with Doors - LEFT*



Glazed door option

Z36L6DIL	24 x 36 x 65-65.5	125	269.85	39	\$1647	\$1701	\$1044	N/A
Z30L6DIL	24 x 30 x 65-65.5	125	240.45	32.75	\$1459	\$1504	\$903	N/A
Z24L6DIL	24 x 24 x 65-65.5	125	208.95	26.75	\$1361	\$1399	\$815	N/A
Z21L6DIL	24 x 21 x 65-65.5	100	193.20	23.50	\$1278	\$1315	\$808	N/A
Z36M6DIL	20 x 36 x 65-65.5	125	243.60	33.25	\$1550	\$1596	\$1044	N/A
Z30M6DIL	20 x 30 x 65-65.5	100	226.80	27.75	\$1353	\$1392	\$903	N/A
Z24M6DIL	20 x 24 x 65-65.5	100	184.80	22.50	\$1214	\$1246	\$815	N/A
Z21M6DIL	20 x 21 x 65-65.5	100	171.15	20	\$1178	\$1210	\$808	N/A

Laminate doors are standard. Storage compartment on **left includes four 3-position fixed/height adjustable shelves**. Wardrobe compartment on **right** includes hanging rod. Single lock secures storage and wardrobe compartments.

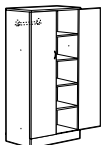

Wardrobe Cabinet/Shelving Combo with Doors - RIGHT*



Glazed door option

Z36L6DIR	24 x 36 x 65-65.5	125	269.85	39	\$1647	\$1701	\$1044	N/A
Z30L6DIR	24 x 30 x 65-65.5	125	240.45	32.75	\$1459	\$1504	\$903	N/A
Z24L6DIR	24 x 24 x 65-65.5	125	208.95	26.75	\$1361	\$1399	\$815	N/A
Z21L6DIR	24 x 21 x 65-65.5	100	193.20	23.50	\$1278	\$1315	\$808	N/A
Z36M6DIR	20 x 36 x 65-65.5	125	243.60	33.25	\$1550	\$1596	\$1044	N/A
Z30M6DIR	20 x 30 x 65-65.5	100	226.80	27.75	\$1353	\$1392	\$903	N/A
Z24M6DIR	20 x 24 x 65-65.5	100	184.80	22.50	\$1214	\$1246	\$815	N/A
Z21M6DIR	20 x 21 x 65-65.5	100	171.15	20	\$1178	\$1210	\$808	N/A

Laminate doors are standard. Storage compartment on **right includes four 3-position fixed/height adjustable shelves**. Wardrobe compartment on **left** includes hanging rod. Single lock secures storage and wardrobe compartments.

Required Specifications

Top finish
Top/edge detail
Handles
Base finish

Optional Specifications

Glazed doors*

WARDROBE CABINETS - 65" / 65.5" HIGH

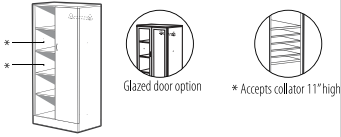

Wardrobe Cabinet/Open Shelving Combo - LEFT*

MODEL#	DIMENSIONS D x W x H	FREIGHT CLASS	WT./LBS.	CUBIC FT.	1" TOP	1.5" TOP	GLAZE ADD	HP ADD
Z36L6DINL	24 x 36 x 65-65.5	125	251.50	39	\$1472	\$1526	\$520	N/A
Z30L6DINL	24 x 30 x 65-65.5	125	224.46	32.75	\$1314	\$1360	\$450	N/A
Z24L6DINL	24 x 24 x 65-65.5	125	196.37	26.75	\$1239	\$1276	\$404	N/A
Z21L6DINL	24 x 21 x 65-65.5	125	183.37	23.50	\$1157	\$1194	\$401	N/A
Z36M6DINL	20 x 36 x 65-65.5	125	223.19	33.25	\$1376	\$1423	\$520	N/A
Z30M6DINL	20 x 30 x 65-65.5	125	197.54	27.75	\$1208	\$1247	\$450	N/A
Z24M6DINL	20 x 24 x 65-65.5	125	174.14	22.50	\$1092	\$1124	\$404	N/A
Z21M6DINL	20 x 21 x 65-65.5	125	159.07	20	\$1056	\$1088	\$401	N/A

Laminate door is standard. Storage compartment on **left includes four 3-position fixed/height adjustable shelves**.
Wardrobe compartment on **right** includes hanging rod. Single lock secures storage and wardrobe compartments.



Wardrobe Cabinet/Open Shelving Combo - RIGHT*

Z36L6DINR	24 x 36 x 65-65.5	125	251.50	39	\$1472	\$1526	\$520	N/A
Z30L6DINR	24 x 30 x 65-65.5	125	224.46	32.75	\$1314	\$1360	\$450	N/A
Z24L6DINR	24 x 24 x 65-65.5	125	196.37	26.75	\$1239	\$1276	\$404	N/A
Z21L6DINR	24 x 21 x 65-65.5	125	183.37	23.50	\$1157	\$1194	\$401	N/A
Z36M6DINR	20 x 36 x 65-65.5	125	223.19	33.25	\$1376	\$1423	\$520	N/A
Z30M6DINR	20 x 30 x 65-65.5	125	197.54	27.75	\$1208	\$1247	\$450	N/A
Z24M6DINR	20 x 24 x 65-65.5	125	174.14	22.50	\$1092	\$1124	\$404	N/A
Z21M6DINR	20 x 21 x 65-65.5	125	159.07	20	\$1056	\$1088	\$401	N/A

Laminate door is standard. Storage compartment on **right includes four 3-position fixed/height adjustable shelves**.
Wardrobe compartment on **left** includes hanging rod. Single lock secures storage and wardrobe compartments.

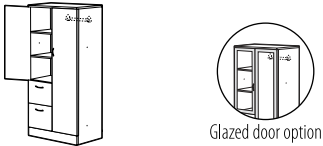

Personal Tower with Doors - LEFT

Z36L6EL	24 x 36 x 65-65.5	125	290.85	39	\$1808	\$1861	\$876	N/A
Z30L6EL	24 x 30 x 65-65.5	100	266.70	32.75	\$1672	\$1718	\$798	N/A
Z24L6EL	24 x 24 x 65-65.5	100	243.24	26.75	\$1603	\$1640	\$699	N/A
Z36M6EL	20 x 36 x 65-65.5	125	256.20	33.25	\$1711	\$1757	\$876	N/A
Z30M6EL	20 x 30 x 65-65.5	100	229.95	27.75	\$1562	\$1601	\$798	N/A
Z24M6EL	20 x 24 x 65-65.5	100	217	22.50	\$1498	\$1530	\$699	N/A

Two file drawers on bottom. Laminate doors are standard. Storage compartment on **left includes two 3-position fixed/height adjustable shelves**. Wardrobe compartment on **right** includes hanging rod. Upper lock secures storage and wardrobe compartments. Lower lock secures all drawers.

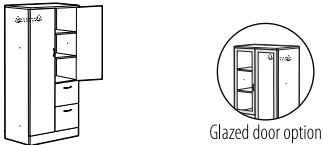

Personal Tower with Doors - RIGHT

Z36L6ER	24 x 36 x 65-65.5	125	290.85	39	\$1808	\$1861	\$876	N/A
Z30L6ER	24 x 30 x 65-65.5	100	266.70	32.75	\$1672	\$1718	\$798	N/A
Z24L6ER	24 x 24 x 65-65.5	100	243.24	26.75	\$1603	\$1640	\$699	N/A
Z36M6ER	20 x 36 x 65-65.5	125	256.20	33.25	\$1711	\$1757	\$876	N/A
Z30M6ER	20 x 30 x 65-65.5	100	229.95	27.75	\$1562	\$1601	\$798	N/A
Z24M6ER	20 x 24 x 65-65.5	100	217	22.50	\$1498	\$1530	\$699	N/A

Two file drawers on bottom. Laminate doors are standard. Storage compartment on **right includes four 3-position fixed/height adjustable shelves**. Wardrobe compartment on **left** includes hanging rod. Upper lock secures storage and wardrobe compartments. Lower lock secures all drawers.

PERSONAL TOWERS - 65" / 65.5" HIGH

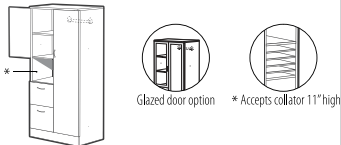

Personal Tower with Doors and cavity - LEFT*

Z36L6ECL	24 x 36 x 65-65.5	125	288.74	39	\$1784	\$1838	\$836	N/A
Z30L6ECL	24 x 30 x 65-65.5	100	264.24	32.75	\$1650	\$1696	\$759	N/A
Z24L6ECL	24 x 24 x 65-65.5	100	239.24	26.75	\$1581	\$1618	\$659	N/A
Z36M6ECL	20 x 36 x 65-65.5	125	252.03	33.25	\$1679	\$1725	\$836	N/A
Z30M6ECL	20 x 30 x 65-65.5	100	226.82	27.75	\$1530	\$1568	\$759	N/A
Z24M6ECL	20 x 24 x 65-65.5	100	213	22.50	\$1476	\$1508	\$659	N/A

Two file drawers on bottom. Laminate doors are standard. Storage compartment on **left includes one 3-position fixed/height adjustable shelf**. Wardrobe compartment on **right** includes hanging rod. Upper lock secures storage and wardrobe compartments. Lower lock secures all drawers.

Required Specifications

- Top finish
- Top/edge detail
- Handles
- Base finish

Optional Specifications

- Collator*
- Glazed doors

PERSONAL TOWERS - 65" / 65.5" HIGH

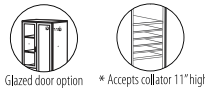
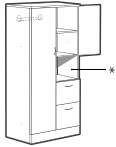

Personal Tower with Doors and cavity - RIGHT*

MODEL#	DIMENSIONS	FREIGHT CLASS	WT/LBS.	CUBIC FT.	1" TOP	1.5" TOP	GLAZE ADD	HP ADD	
D x W x H									
Z36L6ECR	24 x 36 x 65-65.5	125	288.74	39	\$1784	\$1838	\$836	N/A	
Z30L6ECR	24 x 30 x 65-65.5	100	264.24	32.75	\$1650	\$1696	\$759	N/A	
Z24L6ECR	24 x 24 x 65-65.5	100	239.24	26.75	\$1581	\$1618	\$659	N/A	
Z36M6ECR	20 x 36 x 65-65.5	125	252.03	33.25	\$1679	\$1725	\$836	N/A	
Z30M6ECR	20 x 30 x 65-65.5	100	226.82	27.75	\$1530	\$1568	\$759	N/A	
Z24M6ECR	20 x 24 x 65-65.5	100	213	22.50	\$1476	\$1508	\$659	N/A	

Two file drawers on bottom. Laminate doors are standard. Storage compartment on **right includes one 3-position fixed/height adjustable shelf**. Wardrobe compartment on **left** includes hanging rod. Upper lock secures storage and wardrobe compartments. Lower lock secures all drawers.

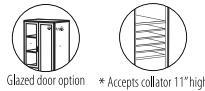
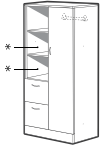

Personal Tower with Open Shelves - LEFT*

Z36L6ENL	24 x 36 x 65-65.5	125	280.48	39	\$1686	\$1739	\$524	N/A
Z30L6ENL	24 x 30 x 65-65.5	125	257.36	32.75	\$1550	\$1596	\$447	N/A
Z24L6ENL	24 x 24 x 65-65.5	100	230.24	26.75	\$1483	\$1520	\$347	N/A
Z36M6ENL	20 x 36 x 65-65.5	125	243.77	33.25	\$1580	\$1626	\$524	N/A
Z30M6ENL	20 x 30 x 65-65.5	125	219.94	27.75	\$1431	\$1470	\$447	N/A
Z24M6ENL	20 x 24 x 65-65.5	100	204	22.50	\$1357	\$1399	\$347	N/A

Two file drawers on bottom. Laminate doors are standard on wardrobe section. Storage compartment on **left includes two 3-position fixed/height adjustable shelves**. Wardrobe compartment on **right** includes hanging rod. Upper lock secures storage and wardrobe compartments. Lower lock secures all drawers.

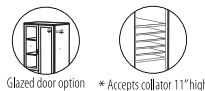
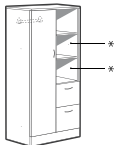

Personal Tower with Open*

Z36L6ENR	24 x 36 x 65-65.5	125	280.48	39	\$1686	\$1739	\$524	N/A
Z30L6ENR	24 x 30 x 65-65.5	125	257.36	32.75	\$1550	\$1596	\$447	N/A
Z24L6ENR	24 x 24 x 65-65.5	100	230.24	26.75	\$1483	\$1520	\$347	N/A
Z36M6ENR	20 x 36 x 65-65.5	125	243.77	33.25	\$1580	\$1626	\$524	N/A
Z30M6ENR	20 x 30 x 65-65.5	125	219.94	27.75	\$1431	\$1470	\$447	N/A
Z24M6ENR	20 x 24 x 65-65.5	100	204	22.50	\$1357	\$1399	\$347	N/A

Two file drawers on bottom. Laminate doors is standard on wardrobe section. Storage compartment on **right includes two 3-position fixed/height adjustable shelves**. Wardrobe compartment on **left** includes hanging rod. Upper lock secures storage and wardrobe compartments. Lower lock secures all drawers.

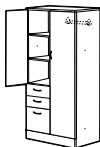

Personal Tower with Doors - LEFT

Z36L6BFL	24 x 36 x 65-65.5	125	294	39	\$1901	\$1954	\$876	N/A
Z30L6BFL	24 x 30 x 65-65.5	100	268.80	32.75	\$1766	\$1812	\$798	N/A
Z24L6BFL	24 x 24 x 65-65.5	100	244.24	26.75	\$1678	\$1716	\$699	N/A
Z36M6BFL	20 x 36 x 65-65.5	125	258.30	33.25	\$1810	\$1856	\$876	N/A
Z30M6BFL	20 x 30 x 65-65.5	100	232.05	27.75	\$1661	\$1700	\$798	N/A
Z24M6BFL	20 x 24 x 65-65.5	100	218	22.50	\$1574	\$1606	\$699	N/A

Two box and one file drawer on bottom. Laminate doors are standard. Storage compartment on **left includes two 3-position fixed/height adjustable shelves**. Wardrobe compartment on **right** includes hanging rod. Upper lock secures storage and wardrobe compartments. Lower lock secures all drawers.

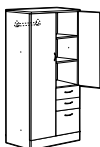

Personal Tower with Doors - RIGHT

Z36L6BFR	24 x 36 x 65-65.5	125	294	39	\$1901	\$1954	\$876	N/A
Z30L6BFR	24 x 30 x 65-65.5	100	268.80	32.75	\$1766	\$1812	\$798	N/A
Z24L6BFR	24 x 24 x 65-65.5	100	244.24	26.75	\$1678	\$1716	\$699	N/A
Z36M6BFR	20 x 36 x 65-65.5	125	258.30	33.25	\$1810	\$1856	\$876	N/A
Z30M6BFR	20 x 30 x 65-65.5	100	232.05	27.75	\$1661	\$1700	\$798	N/A
Z24M6BFR	20 x 24 x 65-65.5	100	218	22.50	\$1574	\$1606	\$699	N/A

Two box and one file drawer on bottom. Laminate doors are standard. Storage compartment on **right includes two 3-position fixed/height adjustable shelves**. Wardrobe compartment on **left** includes hanging rod. Upper lock secures storage and wardrobe compartments. Lower lock secures all drawers.

Required Specifications

Top finish
Top/edge detail
Handles
Base finish

Optional Specifications

Collator*
Glazed doors
Box drawer - no upcharge

PERSONAL TOWERS - 65" / 65.5" HIGH

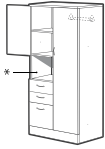

Personal Tower with Doors*

MODEL#	DIMENSIONS D x W x H	FREIGHT CLASS	WT./LBS.	CUBIC FT.	1" TOP	1.5" TOP	GLAZE ADD	HP ADD
Z36L6BFCL	24 x 36 x 65-65.5	125	291.89	39	\$1879	\$1933	\$836	N/A
Z30L6BFCL	24 x 30 x 65-65.5	100	266.34	32.75	\$1745	\$1791	\$759	N/A
Z24L6BFCL	24 x 24 x 65-65.5	100	240.24	26.75	\$1656	\$1694	\$659	N/A
Z36M6BFCL	20 x 36 x 65-65.5	125	254.13	33.25	\$1773	\$1819	\$836	N/A
Z30M6BFCL	20 x 30 x 65-65.5	100	228.92	27.75	\$1623	\$1662	\$759	N/A
Z24M6BFCL	20 x 24 x 65-65.5	100	214	22.50	\$1553	\$1585	\$659	N/A

Two box and one file drawer on bottom. Laminate doors are standard. Storage compartment on **left** includes **one 3-position fixed/height adjustable shelf**. Wardrobe compartment on **right** includes hanging rod. Upper lock secures storage and wardrobe compartments. Lower lock secures all drawers.

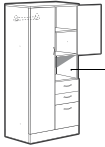

Personal Tower with Doors and Cavity - RIGHT*

Z36L6BFCL	24 x 36 x 65-65.5	125	291.89	39	\$1879	\$1933	\$836	N/A
Z30L6BFCL	24 x 30 x 65-65.5	100	266.34	32.75	\$1745	\$1791	\$759	N/A
Z24L6BFCL	24 x 24 x 65-65.5	100	240.24	26.75	\$1656	\$1694	\$659	N/A
Z36M6BFCL	20 x 36 x 65-65.5	125	254.13	33.25	\$1773	\$1819	\$836	N/A
Z30M6BFCL	20 x 30 x 65-65.5	100	228.92	27.75	\$1623	\$1662	\$759	N/A
Z24M6BFCL	20 x 24 x 65-65.5	100	214	22.50	\$1553	\$1585	\$659	N/A

Two box and one file drawer on bottom. Laminate doors are standard. Storage compartment on **left** includes **one 3-position fixed/height adjustable shelf**. Wardrobe compartment on **right** includes hanging rod. Upper lock secures storage and wardrobe compartments. Lower lock secures all drawers.

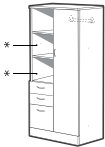

Personal Tower with Open Shelves - LEFT*

Z36L6BFNL	24 x 36 x 65-65.5	125	280	39	\$1780	\$1833	\$524	N/A
Z30L6BFNL	24 x 30 x 65-65.5	125	257	32.75	\$1645	\$1691	\$447	N/A
Z24L6BFNL	24 x 24 x 65-65.5	100	232	26.75	\$1559	\$1596	\$347	N/A
Z36M6BFNL	20 x 36 x 65-65.5	125	242	33.25	\$1688	\$1734	\$524	N/A
Z30M6BFNL	20 x 30 x 65-65.5	125	219	27.75	\$1539	\$1578	\$447	N/A
Z24M6BFNL	20 x 24 x 65-65.5	100	206	22.50	\$1467	\$1499	\$347	N/A

Two box and one file drawer on bottom. Laminate doors are standard. Storage compartment on **left** includes **two 3-position fixed/height adjustable shelves**. Wardrobe compartment on **right** includes hanging rod. Upper lock secures storage and wardrobe compartments. Lower lock secures all drawers.

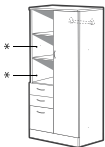

Personal Tower with Open Shelves - RIGHT*

Z36L6BFNR	24 x 36 x 65-65.5	125	280	39	\$1780	\$1833	\$524	N/A
Z30L6BFNR	24 x 30 x 65-65.5	125	257	32.75	\$1645	\$1691	\$447	N/A
Z24L6BFNR	24 x 24 x 65-65.5	100	232	26.75	\$1559	\$1596	\$347	N/A
Z36M6BFNR	20 x 36 x 65-65.5	125	242	33.25	\$1688	\$1734	\$524	N/A
Z30M6BFNR	20 x 30 x 65-65.5	125	219	27.75	\$1539	\$1578	\$447	N/A
Z24M6BFNR	20 x 24 x 65-65.5	100	206	22.50	\$1467	\$1499	\$347	N/A

Two box and one file drawer on bottom. Laminate doors are standard. Storage compartment on **right** includes **two 3-position fixed/height adjustable shelves**. Wardrobe compartment on **left** includes hanging rod. Upper lock secures storage and wardrobe compartments. Lower lock secures all drawers.

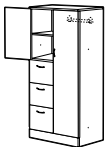

Personal Tower with Doors - LEFT

Z36L63FL	24 x 36 x 65-65.5	125	295.05	39	\$1904	\$1957	\$836	N/A
Z30L63FL	24 x 30 x 65-65.5	100	273	32.75	\$1778	\$1824	\$759	N/A
Z24L63FL	24 x 24 x 65-65.5	100	247.24	26.75	\$1683	\$1720	\$659	N/A
Z36M63FL	20 x 36 x 65-65.5	125	262.50	33.25	\$1817	\$1863	\$836	N/A
Z30M63FL	20 x 30 x 65-65.5	100	236.25	27.75	\$1675	\$1714	\$759	N/A
Z24M63FL	20 x 24 x 65-65.5	100	223	22.50	\$1582	\$1614	\$659	N/A

Three file drawers on bottom. Laminate doors are standard. Storage compartment on **left** includes **one 3-position fixed/height adjustable shelf**. Wardrobe compartment on **right** includes hanging rod. Upper lock secures storage and wardrobe compartments. Lower lock secures all drawers.

Required Specifications

- Top finish
- Top/edge detail
- Handles
- Base finish

Optional Specifications

- Collator*
- Glazed doors
- Box drawer - no upcharge

PERSONAL TOWERS - 65" / 65.5" HIGH

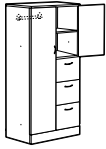

Glazed door option

Personal Tower with Doors - RIGHT

MODEL#	DIMENSIONS D x W x H	FREIGHT CLASS	WT/LBS.	CUBIC FT.	1" TOP	1.5" TOP	GLAZE ADD	HP ADD
Z36L63FR	24 x 36 x 65-65.5	125	295.05	39	\$1904	\$1957	\$836	N/A
Z30L63FR	24 x 30 x 65-65.5	100	273	32.75	\$1778	\$1824	\$759	N/A
Z24L63FR	24 x 24 x 65-65.5	100	247.24	26.75	\$1683	\$1720	\$659	N/A
Z36M63FR	20 x 36 x 65-65.5	125	262.50	33.25	\$1817	\$1863	\$836	N/A
Z30M63FR	20 x 30 x 65-65.5	100	236.25	27.75	\$1675	\$1714	\$759	N/A
Z24M63FR	20 x 24 x 65-65.5	100	223	22.50	\$1582	\$1614	\$659	N/A

Three file drawers on bottom. Laminate doors are standard. Storage compartment on right includes one 3-position fixed/height adjustable shelf. Wardrobe compartment on left includes hanging rod. Upper lock secures storage and wardrobe compartments. Lower lock secures all drawers.

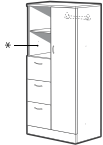

Glazed door option * Accepts collator 11" high

Personal Tower with Open Shelves - LEFT*

Z36L63FNL	24 x 36 x 65-65.5	125	288.67	39	\$1805	\$1859	\$524	N/A
Z30L63FNL	24 x 30 x 65-65.5	100	264.89	32.75	\$1678	\$1724	\$447	N/A
Z24L63FNL	24 x 24 x 65-65.5	100	238.24	26.75	\$1583	\$1621	\$347	N/A
Z36M63FNL	20 x 36 x 65-65.5	125	261.41	33.25	\$1704	\$1750	\$524	N/A
Z30M63FNL	20 x 30 x 65-65.5	100	229.57	27.75	\$1562	\$1601	\$447	N/A
Z24M63FNL	20 x 24 x 65-65.5	100	213	22.50	\$1484	\$1516	\$347	N/A

Three file drawers on bottom. Laminate door is standard on wardrobe section. Storage compartment on left includes one 3-position fixed/height adjustable shelf. Wardrobe compartment on right includes hanging rod. Upper lock secures storage and wardrobe compartments. Lower lock secures all drawers.

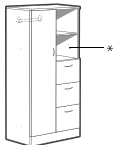

Glazed door option * Accepts collator 11" high

Personal Tower with Open Shelves - RIGHT*

Z36L63FNR	24 x 36 x 65-65.5	125	288.67	39	\$1805	\$1859	\$524	N/A
Z30L63FNR	24 x 30 x 65-65.5	100	264.89	32.75	\$1678	\$1724	\$447	N/A
Z24L63FNR	24 x 24 x 65-65.5	100	238.24	26.75	\$1583	\$1621	\$347	N/A
Z36M63FNR	20 x 36 x 65-65.5	125	261.41	33.25	\$1704	\$1750	\$524	N/A
Z30M63FNR	20 x 30 x 65-65.5	100	229.57	27.75	\$1562	\$1601	\$447	N/A
Z24M63FNR	20 x 24 x 65-65.5	100	213	22.50	\$1484	\$1516	\$347	N/A

Three file drawers on bottom. Laminate door is standard on wardrobe section. Storage compartment on right includes one 3-position fixed/height adjustable shelf. Wardrobe compartment on left includes hanging rod. Upper lock secures storage and wardrobe compartments. Lower lock secures all drawers.

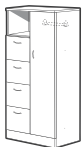

Glazed door option

Personal Tower with Open Shelf - LEFT

Z36L64FNL	24 x 36 x 65-65.5	125	302.40	39	\$1895	\$1948	\$524	N/A
Z30L64FNL	24 x 30 x 65-65.5	100	277.20	32.75	\$1775	\$1821	\$447	N/A
Z24L64FNL	24 x 24 x 65-65.5	100	247.24	26.75	\$1685	\$1723	\$347	N/A
Z36M64FNL	20 x 36 x 65-65.5	125	263.55	33.25	\$1794	\$1840	\$524	N/A
Z30M64FNL	20 x 30 x 65-65.5	100	238.35	27.75	\$1656	\$1695	\$447	N/A
Z24M64FNL	20 x 24 x 65-65.5	100	223	22.50	\$1589	\$1622	\$347	N/A

Four file drawers on bottom. Laminate door is standard on wardrobe section. Storage compartment on left includes one 3-position fixed/height adjustable shelf. Wardrobe compartment on right includes hanging rod. Upper lock secures storage and wardrobe compartments. Lower lock secures all drawers.



Glazed door option

Personal Tower with Open Shelf - RIGHT

Z36L64FNR	24 x 36 x 65-65.5	125	302.40	39	\$1895	\$1948	\$524	N/A
Z30L64FNR	24 x 30 x 65-65.5	100	277.20	32.75	\$1775	\$1821	\$447	N/A
Z24L64FNR	24 x 24 x 65-65.5	100	247.24	26.75	\$1685	\$1723	\$347	N/A
Z36M64FNR	20 x 36 x 65-65.5	125	263.55	33.25	\$1794	\$1840	\$524	N/A
Z30M64FNR	20 x 30 x 65-65.5	100	238.35	27.75	\$1656	\$1695	\$447	N/A
Z24M64FNR	20 x 24 x 65-65.5	100	223	22.50	\$1589	\$1622	\$347	N/A

Four file drawers on bottom. Laminate door is standard on wardrobe section. Storage compartment on right includes one 3-position fixed/height adjustable shelf. Wardrobe compartment on left includes hanging rod. Upper lock secures storage and wardrobe compartments. Lower lock secures all drawers.

Required Specifications

Top finish
Top/edge detail
Handles
Base finish

Optional Specifications

Collator*
Glazed doors
Box drawer - no upcharge

STORAGE MODULES - 71.5" / 72" HIGH

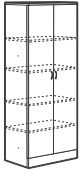

Glazed door option

Storage Cabinet with Doors

MODEL#	DIMENSIONS D x W x H	FREIGHT CLASS	WT./LBS.	CUBIC FT.	1" TOP	1.5" TOP	GLAZE ADD	HP ADD
Z36L7SH	24 x 36 x 71.5-72	125	295.05	43.25	\$1682	\$1735	\$1126	N/A
Z30L7SH	24 x 30 x 71.5-72	125	253.05	36.25	\$1467	\$1513	\$973	N/A
Z36M7SH	20 x 36 x 71.5-72	125	261.45	36.75	\$1561	\$1607	\$1126	N/A
Z30M7SH	20 x 30 x 71.5-72	125	225.75	30.50	\$1353	\$1391	\$973	N/A
Z36S7SH	16 x 36 x 71.5-72	125	225.75	29.50	\$1400	\$1445	\$1126	N/A
Z30S7SH	16 x 30 x 71.5-72	125	195.30	25	\$1230	\$1261	\$973	N/A

Laminate doors are standard. **Includes four 3-position fixed/height adjustable shelves.** Standard with lock.

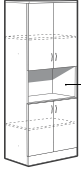

Glazed door option



* Accepts collator 11" high

Storage Cabinet with Doors and Cavity

Z36L7SHC	24 x 36 x 71.5-72	125	286.85	43.25	\$1747	\$1801	\$1255	N/A
Z30L7SHC	24 x 30 x 71.5-72	125	247.27	36.25	\$1553	\$1599	\$1100	N/A
Z36M7SHC	20 x 36 x 71.5-72	125	254.34	36.75	\$1627	\$1673	\$1255	N/A
Z30M7SHC	20 x 30 x 71.5-72	125	219.30	30.50	\$1438	\$1476	\$1100	N/A
Z36S7SHC	16 x 36 x 71.5-72	125	218.67	29.50	\$1466	\$1511	\$1255	N/A
Z30S7SHC	16 x 30 x 71.5-72	125	189.23	25	\$1315	\$1346	\$1100	N/A

Laminate doors are standard. **Includes two 3-position fixed/height adjustable shelves.** Upper and lower locks secure both compartments.



Glazed door option

Storage Cabinet with Door - LEFT

Z21L7SHL	24 x 21 x 71.5-72	125	196.35	26	\$1215	\$1252	\$624	N/A
Z18L7SHL	24 x 18 x 71.5-72	125	178.50	22.75	\$1133	\$1165	\$560	N/A
Z16L7SHL	24 x 16 x 71.5-72	100	166.95	20.75	\$1065	\$1097	\$555	N/A
Z15L7SHL	24 x 15 x 71.5-72	100	160.65	19.25	\$1018	\$1044	\$482	N/A
Z12L7SHL	24 x 12 x 71.5-72	100	136.50	16	\$935	\$958	\$433	N/A
Z21M7SHL	20 x 21 x 71.5-72	100	174.30	21.25	\$1087	\$1118	\$624	N/A
Z18M7SHL	20 x 18 x 71.5-72	100	156.45	19.25	\$1036	\$1064	\$560	N/A
Z16M7SHL	20 x 16 x 71.5-72	100	147	17.50	\$973	\$1000	\$555	N/A
Z15M7SHL	20 x 15 x 71.5-72	100	139.65	16.25	\$929	\$950	\$482	N/A
Z12M7SHL	20 x 12 x 71.5-72	100	123.90	13.25	\$852	\$870	\$433	N/A
Z21S7SHL	16 x 21 x 71.5-72	100	150.15	18	\$1002	\$1028	\$624	N/A
Z18S7SHL	16 x 18 x 71.5-72	100	134.40	15.50	\$932	\$959	\$560	N/A
Z16S7SHL	16 x 16 x 71.5-72	100	124.95	14	\$893	\$919	\$555	N/A
Z15S7SHL	16 x 15 x 71.5-72	100	118.65	12.50	\$859	\$879	\$482	N/A
Z12S7SHL	16 x 12 x 71.5-72	100	103.95	11	\$754	\$772	\$433	N/A

Laminate doors are standard. **Includes four 3-position fixed/height adjustable shelves.** Standard with lock.



Glazed door option

Storage Cabinet with Door - RIGHT

Z21L7SHR	24 x 21 x 71.5-72	125	196.35	26	\$1215	\$1252	\$624	N/A
Z18L7SHR	24 x 18 x 71.5-72	125	178.50	22.75	\$1133	\$1165	\$560	N/A
Z16L7SHR	24 x 16 x 71.5-72	100	166.95	20.75	\$1065	\$1097	\$555	N/A
Z15L7SHR	24 x 15 x 71.5-72	100	160.65	19.25	\$1018	\$1044	\$482	N/A
Z12L7SHR	24 x 12 x 71.5-72	100	136.50	16	\$935	\$958	\$433	N/A
Z21M7SHR	20 x 21 x 71.5-72	100	174.30	21.25	\$1087	\$1118	\$624	N/A
Z18M7SHR	20 x 18 x 71.5-72	100	156.45	19.25	\$1036	\$1064	\$560	N/A
Z16M7SHR	20 x 16 x 71.5-72	100	147	17.50	\$973	\$1000	\$555	N/A
Z15M7SHR	20 x 15 x 71.5-72	100	139.65	16.25	\$929	\$950	\$482	N/A
Z12M7SHR	20 x 12 x 71.5-72	100	123.90	13.25	\$852	\$870	\$433	N/A
Z21S7SHR	16 x 21 x 71.5-72	100	150.15	18	\$1002	\$1028	\$624	N/A
Z18S7SHR	16 x 18 x 71.5-72	100	134.40	15.50	\$932	\$959	\$560	N/A
Z16S7SHR	16 x 16 x 71.5-72	100	124.95	14	\$893	\$919	\$555	N/A
Z15S7SHR	16 x 15 x 71.5-72	100	118.65	12.50	\$859	\$879	\$482	N/A
Z12S7SHR	16 x 12 x 71.5-72	100	103.95	11	\$754	\$772	\$433	N/A

Laminate doors are standard. **Includes four 3-position fixed/height adjustable shelves.** Standard with lock.

Required Specifications

Finishes
Top/Edge Detail
Handles

Optional Specifications

Glazing - Doors
Collator (Open Shelves)

STORAGE MODULES - 71.5" / 72" HIGH

MODEL#	DIMENSIONS	FREIGHT CLASS	WT/LBS.	CUBIC FT.	1" TOP	1.5" TOP	GLAZE ADD	HP ADD
D x W x H								
Z21L7SHCL	24 x 21 x 71.5-72	125	193.67	26	\$1251	\$1288	\$689	N/A
Z18L7SHCL	24 x 18 x 71.5-72	125	175.45	22.75	\$1169	\$1201	\$622	N/A
Z16L7SHCL	24 x 16 x 71.5-72	125	163.66	20.75	\$1100	\$1131	\$613	N/A
Z15L7SHCL	24 x 15 x 71.5-72	100	157.23	19.25	\$1055	\$1081	\$544	N/A
Z12L7SHCL	24 x 12 x 71.5-72	100	133.77	16	\$939	\$960	\$492	N/A
Z21M7SHCL	20 x 21 x 71.5-72	100	170.41	21.25	\$1122	\$1154	\$689	N/A
Z18M7SHCL	20 x 18 x 71.5-72	125	153.42	19.25	\$1073	\$1100	\$622	N/A
Z16M7SHCL	20 x 16 x 71.5-72	100	143.84	17.50	\$1007	\$1034	\$613	N/A
Z15M7SHCL	20 x 15 x 71.5-72	100	137.47	16.25	\$964	\$987	\$544	N/A
Z12M7SHCL	20 x 12 x 71.5-72	100	121.53	13.25	\$895	\$913	\$492	N/A
Z21S7SHCL	16 x 21 x 71.5-72	100	146.11	18	\$1038	\$1063	\$689	N/A
Z18S7SHCL	16 x 18 x 71.5-72	100	131.39	15.50	\$968	\$995	\$622	N/A
Z16S7SHCL	16 x 16 x 71.5-72	100	121.92	14	\$927	\$953	\$613	N/A
Z15S7SHCL	16 x 15 x 71.5-72	100	115.61	12.50	\$896	\$916	\$544	N/A
Z12S7SHCL	16 x 12 x 71.5-72	100	101.94	11	\$798	\$816	\$492	N/A

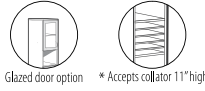
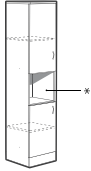

Storage Cabinet with Doors and Cavity - LEFT

Laminate doors are standard. **Includes two adjustable shelves.** Upper and lower locks secure both compartments

Z21L7SHCR	24 x 21 x 71.5-72	125	193.67	26	\$1251	\$1288	\$689	N/A
Z18L7SHCR	24 x 18 x 71.5-72	125	175.45	22.75	\$1169	\$1201	\$622	N/A
Z16L7SHCR	24 x 16 x 71.5-72	125	163.66	20.75	\$1100	\$1131	\$613	N/A
Z15L7SHCR	24 x 15 x 71.5-72	100	157.23	19.25	\$1055	\$1081	\$544	N/A
Z12L7SHCR	24 x 12 x 71.5-72	100	133.77	16	\$939	\$960	\$492	N/A
Z21M7SHCR	20 x 21 x 71.5-72	100	170.41	21.25	\$1122	\$1154	\$689	N/A
Z18M7SHCR	20 x 18 x 71.5-72	125	153.42	19.25	\$1073	\$1100	\$622	N/A
Z16M7SHCR	20 x 16 x 71.5-72	100	143.84	17.50	\$1007	\$1034	\$613	N/A
Z15M7SHCR	20 x 15 x 71.5-72	100	137.47	16.25	\$964	\$987	\$544	N/A
Z12M7SHCR	20 x 12 x 71.5-72	100	121.53	13.25	\$895	\$913	\$492	N/A
Z21S7SHCR	16 x 21 x 71.5-72	100	146.11	18	\$1038	\$1063	\$689	N/A
Z18S7SHCR	16 x 18 x 71.5-72	100	131.39	15.50	\$968	\$995	\$622	N/A
Z16S7SHCR	16 x 16 x 71.5-72	100	121.92	14	\$927	\$953	\$613	N/A
Z15S7SHCR	16 x 15 x 71.5-72	100	115.61	12.50	\$896	\$916	\$544	N/A
Z12S7SHCR	16 x 12 x 71.5-72	100	101.94	11	\$798	\$816	\$492	N/A

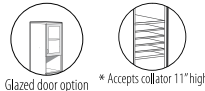
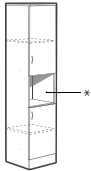

Storage Cabinet with Doors and Cavity - RIGHT

Laminate doors are standard. **Includes two adjustable shelves.** Upper and lower locks secure both compartments

Z36L7SHN	24 x 36 x 71.5-72	150	249.61	43.25	\$1313	\$1367	N/A	N/A
Z30L7SHN	24 x 30 x 71.5-72	150	216.23	36.25	\$1165	\$1211	N/A	N/A
Z21L7SHN	24 x 21 x 71.5-72	125	171.94	26	\$1008	\$1045	N/A	N/A
Z18L7SHN	24 x 18 x 71.5-72	125	156.83	22.75	\$947	\$979	N/A	N/A
Z16L7SHN	24 x 16 x 71.5-72	125	147.10	20.75	\$879	\$910	N/A	N/A
Z15L7SHN	24 x 15 x 71.5-72	125	141.72	19.25	\$854	\$880	N/A	N/A
Z12L7SHN	24 x 12 x 71.5-72	125	121.35	16	\$790	\$871	N/A	N/A
Z36M7SHN	20 x 36 x 71.5-72	150	217.09	36.75	\$1193	\$1239	N/A	N/A
Z30M7SHN	20 x 30 x 71.5-72	125	188.26	30.50	\$1049	\$1088	N/A	N/A
Z21M7SHN	20 x 21 x 71.5-72	125	148.69	21.25	\$798	\$829	N/A	N/A
Z18M7SHN	20 x 18 x 71.5-72	125	134.80	19.25	\$849	\$877	N/A	N/A
Z16M7SHN	20 x 16 x 71.5-72	125	127.29	17.50	\$787	\$814	N/A	N/A
Z15M7SHN	20 x 15 x 71.5-72	125	121.96	16.25	\$765	\$788	N/A	N/A
Z12M7SHN	20 x 12 x 71.5-72	100	109.11	13.25	\$706	\$724	N/A	N/A
Z36S7SHN	16 x 36 x 71.5-72	125	181.43	29.50	\$1032	\$1078	N/A	N/A
Z30S7SHN	16 x 30 x 71.5-72	125	158.19	25	\$927	\$958	N/A	N/A
Z21S7SHN	16 x 21 x 71.5-72	125	124.38	18	\$796	\$821	N/A	N/A
Z18S7SHN	16 x 18 x 71.5-72	125	112.77	15.50	\$745	\$772	N/A	N/A
Z16S7SHN	16 x 16 x 71.5-72	125	105.37	14	\$706	\$732	N/A	N/A
Z15S7SHN	16 x 15 x 71.5-72	100	100.10	12.50	\$697	\$717	N/A	N/A
Z12S7SHN	16 x 12 x 71.5-72	100	89.53	11	\$608	\$626	N/A	N/A

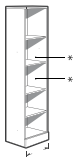
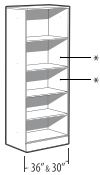

Open Storage Cabinet

Four adjustable shelves.

Required Specifications

Finishes
Top/Edge Detail
Handles

Optional Specifications

Glazing - Doors
Collator (Open Shelves)

STORAGE MODULES - 71.5" / 72" HIGH

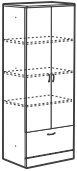

File Module with Doors

MODEL#	DIMENSIONS D x W x H	FREIGHT CLASS	WT./LBS.	CUBIC FT.	1" TOP	1.5" TOP	GLAZE ADD	HP ADD
Z36L7F	24 x 36 x 71.5-72	125	310.80	43.25	\$1969	\$2023	\$1047	N/A
Z30L7F	24 x 30 x 71.5-72	125	270.90	36.25	\$1759	\$1805	\$907	N/A
Z36M7F	20 x 36 x 71.5-72	125	279.30	36.75	\$1846	\$1892	\$1047	N/A
Z30M7F	20 x 30 x 71.5-72	100	244.65	30.50	\$1649	\$1688	\$907	N/A
Z36S7F	16 x 36 x 71.5-72	100	239.40	29.50	\$1658	\$1703	\$1047	N/A
Z30S7F	16 x 30 x 71.5-72	100	207.90	25	\$1486	\$1517	\$907	N/A

One lateral file drawer. Laminate doors are standard. **Includes three adjustable shelves.** Upper lock secures storage compartment. Lower lock secures one file drawer. Front-to-back and side-to-side letter/legal filing capability. Side-to-side file bars included.

- Lateral file drawer construction is for accommodating hanging files NOT for stacking materials on the drawer bottom.



File Module with Door - LEFT

Z16L7FL	24 x 16 x 71.5-72	100	178.50	20.75	\$1202	\$1233	\$503	N/A
Z15L7FL	24 x 15 x 71.5-72	100	171.15	19.25	\$1130	\$1156	\$436	N/A
Z16M7FL	20 x 16 x 71.5-72	100	157.50	17.50	\$1110	\$1137	\$503	N/A
Z15M7FL	20 x 15 x 71.5-72	100	151.20	16.25	\$1062	\$1085	\$436	N/A
Z16S7FL	16 x 16 x 71.5-72	100	132.30	14	\$1022	\$1048	\$503	N/A
Z15S7FL	16 x 15 x 71.5-72	92.5	127.05	12.50	\$992	\$1013	\$436	N/A

One file drawer. Laminate door is standard. **Includes three adjustable shelves.** Upper lock secures storage compartment. Lower lock secures one file drawer.



File Module with Door - RIGHT

Z16L7FR	24 x 16 x 71.5-72	100	178.50	20.75	\$1202	\$1233	\$503	N/A
Z15L7FR	24 x 15 x 71.5-72	100	171.15	19.25	\$1130	\$1156	\$436	N/A
Z16M7FR	20 x 16 x 71.5-72	100	157.50	17.50	\$1110	\$1137	\$503	N/A
Z15M7FR	20 x 15 x 71.5-72	100	151.20	16.25	\$1062	\$1085	\$436	N/A
Z16S7FR	16 x 16 x 71.5-72	100	132.30	14	\$1022	\$1048	\$503	N/A
Z15S7FR	16 x 15 x 71.5-72	92.5	127.05	12.50	\$992	\$1013	\$436	N/A

One file drawer. Laminate door is standard. **Includes three adjustable shelves.** Upper lock secures storage compartment. Lower lock secures one file drawer.

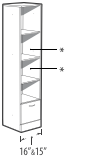
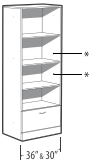

* Accepts collator 11" high

File Module with Open Shelves

Z36L7FN	24 x 36 x 71.5-72	125	275.44	43.25	\$1629	\$1682	N/A	N/A
Z30L7FN	24 x 30 x 71.5-72	125	240.73	36.25	\$1462	\$1508	N/A	N/A
Z16L7FN	24 x 16 x 71.5-72	125	162.20	20.75	\$1028	\$1059	N/A	N/A
Z15L7FN	24 x 15 x 71.5-72	100	155.54	19.25	\$966	\$992	N/A	N/A
Z36M7FN	20 x 36 x 71.5-72	125	242.92	36.75	\$1502	\$1548	N/A	N/A
Z30M7FN	20 x 30 x 71.5-72	125	213.81	30.50	\$1352	\$1390	N/A	N/A
Z16M7FN	20 x 16 x 71.5-72	100	141.33	17.50	\$937	\$964	N/A	N/A
Z15M7FN	20 x 15 x 71.5-72	100	136.83	16.25	\$898	\$921	N/A	/A
Z36S7FN	16 x 36 x 71.5-72	125	203.06	29.50	\$1318	\$1363	N/A	N/A
Z30S7FN	16 x 30 x 71.5-72	125	177.44	25	\$1187	\$1218	N/A	N/A
Z16S7FN	16 x 16 x 71.5-72	100	116.27	14	\$849	\$875	N/A	N/A
Z15S7FN	16 x 15 x 71.5-72	100	111.82	12.50	\$840	\$860	N/A	N/A

Four open shelves and one file drawer on bottom. **Includes three adjustable shelves.** Lock secures file drawer. 36" and 30" wide models have front-to-back and side-to-side letter/legal filing capability. Side-to-side file bars included.

- Lateral file drawer construction is for accommodating hanging files NOT for stacking materials on the drawer bottom.

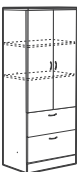

Two File Module with Doors

Z36L7E	24 x 36 x 71.5-72	125	316.05	43.25	\$2145	\$2198	\$886	N/A
Z30L7E	24 x 30 x 71.5-72	125	276.15	36.25	\$1960	\$2006	\$771	N/A
Z36M7E	20 x 36 x 71.5-72	125	285.60	36.75	\$2031	\$2077	\$886	N/A
Z30M7E	20 x 30 x 71.5-72	100	249.90	30.50	\$1851	\$1890	\$771	N/A
Z36S7E	16 x 36 x 71.5-72	100	244.65	29.50	\$1856	\$1902	\$886	N/A
Z30S7E	16 x 30 x 71.5-72	100	213.15	25	\$1673	\$1704	\$771	N/A

Two lateral file drawers. Laminate doors are standard. **Includes two adjustable shelves.** Upper lock secures storage compartment. Lower lock secures two file drawers. Front-to-back and side-to-side letter/legal filing capability. Side-to-side file bars included.

- Lateral file drawer construction is for accommodating hanging files NOT for stacking materials on the drawer bottom.

Required Specifications

Finishes
Top/Edge Detail
Handles

Optional Specifications

Glazing - Doors
Collator (Open Shelves)
Box Drawer Option (no upcharge)

STORAGE MODULES - 71.5" / 72" HIGH



Glazed door option

Two File Module with Door - LEFT

MODEL#	DIMENSIONS D x W x H	FREIGHT CLASS	WT/LBS.	CUBIC FT.	1" TOP	1.5" TOP	GLAZE ADD	HP ADD
Z16L7EL	24 x 16 x 71.5-72	100	181.65	20.75	\$1265	\$1297	\$435	N/A
Z15L7EL	24 x 15 x 71.5-72	100	176.40	19.25	\$1215	\$1241	\$382	N/A
Z16M7EL	20 x 16 x 71.5-72	100	162.75	17.50	\$1175	\$1202	\$435	N/A
Z15M7EL	20 x 15 x 71.5-72	100	155.40	16.25	\$1129	\$1152	\$382	N/A
Z16S7EL	16 x 16 x 71.5-72	100	137.55	14	\$1094	\$1120	\$435	N/A
Z15S7EL	16 x 15 x 71.5-72	92.5	132.30	12.50	\$1068	\$1088	\$382	N/A

Two file drawers on bottom. Laminate door is standard. **Includes two 3-position fixed/height adjustable shelves.** Upper lock secures storage compartment. Lower lock secures two file drawers.

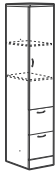

Glazed door option

Two File Module with Door - RIGHT

Z16L7ER	24 x 16 x 71.5-72	100	181.65	20.75	\$1265	\$1297	\$435	N/A
Z15L7ER	24 x 15 x 71.5-72	100	176.40	19.25	\$1215	\$1241	\$382	N/A
Z16M7ER	20 x 16 x 71.5-72	100	162.75	17.50	\$1175	\$1202	\$435	N/A
Z15M7ER	20 x 15 x 71.5-72	100	155.40	16.25	\$1129	\$1152	\$382	N/A
Z16S7ER	16 x 16 x 71.5-72	100	137.55	14	\$1094	\$1120	\$435	N/A
Z15S7ER	16 x 15 x 71.5-72	92.5	132.30	12.50	\$1068	\$1088	\$382	N/A

Two file drawers on bottom. Laminate door is standard. **Includes two 3-position fixed/height adjustable shelves.** Upper lock secures storage compartment. Lower lock secures two file drawers.

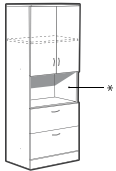

Glazed door option



* Accepts collator 11" high

Two File Module with Doors and Cavity

Z36L7EC	24 x 36 x 71.5-72	125	307.85	43.25	\$2102	\$2155	\$697	N/A
Z30L7EC	24 x 30 x 71.5-72	125	270.37	36.25	\$1924	\$1970	\$606	N/A
Z36M7EC	20 x 36 x 71.5-72	125	278.49	36.75	\$1988	\$2034	\$697	N/A
Z30M7EC	20 x 30 x 71.5-72	125	243.45	30.50	\$1816	\$1855	\$606	N/A
Z36S7EC	16 x 36 x 71.5-72	100	237.57	29.50	\$1686	\$1731	\$697	N/A
Z30S7EC	16 x 30 x 71.5-72	100	207.08	25	\$1510	\$1541	\$606	N/A

Two lateral file drawers on bottom. Laminate doors are standard. **Includes one 3-position fixed/height adjustable shelf.** Upper lock secures storage compartment. Lower lock secures all drawers. Front-to-back and side-to-side letter/legal filing capability. Side-to-side file bars included.

- Lateral file drawer construction is for accommodating hanging files NOT for stacking materials on the drawer bottom.

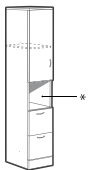

Glazed door option



* Accepts collator 11" high

Two File Module with Doors Cavity - LEFT

Z16L7ECL	24 x 16 x 71.5-72	100	178.36	20.75	\$1243	\$1275	\$343	N/A
Z15L7ECL	24 x 15 x 71.5-72	100	172.98	19.25	\$1199	\$1225	\$302	N/A
Z16M7ECL	20 x 16 x 71.5-72	100	159.59	17.50	\$1143	\$1170	\$343	N/A
Z15M7ECL	20 x 15 x 71.5-72	100	153.22	16.25	\$1102	\$1123	\$302	N/A
Z16S7ECL	16 x 16 x 71.5-72	100	134.52	14	\$1071	\$1097	\$343	N/A
Z15S7ECL	16 x 15 x 71.5-72	92.5	129.26	12.50	\$1050	\$1071	\$302	N/A

Two lateral file drawers on bottom. Laminate doors are standard. **Includes one 3-position fixed/height adjustable shelf.** Upper lock secures storage compartment. Lower lock secures all drawers.

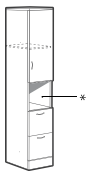

Glazed door option



* Accepts collator 11" high

Two File Module with Doors Cavity - LEFT

Z16L7ECR	24 x 16 x 71.5-72	100	178.36	20.75	\$1243	\$1275	\$343	N/A
Z15L7ECR	24 x 15 x 71.5-72	100	172.98	19.25	\$1199	\$1225	\$302	N/A
Z16M7ECR	20 x 16 x 71.5-72	100	159.59	17.50	\$1143	\$1170	\$343	N/A
Z15M7ECR	20 x 15 x 71.5-72	100	153.22	16.25	\$1102	\$1123	\$302	N/A
Z16S7ECR	16 x 16 x 71.5-72	100	134.52	14	\$1071	\$1097	\$343	N/A
Z15S7ECR	16 x 15 x 71.5-72	92.5	129.26	12.50	\$1050	\$1071	\$302	N/A

Two lateral file drawers on bottom. Laminate doors are standard. **Includes one 3-position fixed/height adjustable shelf.** Upper lock secures storage compartment. Lower lock secures all drawers.

Required Specifications

Finishes
Top/Edge Detail
Handles

Optional Specifications

Glazing - Doors
Collator (Open Shelves)
Box Drawer Option (no upcharge)

STORAGE MODULES - 71.5" / 72" HIGH

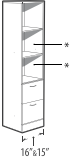
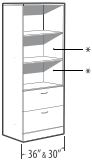

Two File Module with Open Shelves

MODEL#	DIMENSIONS D x W x H	FREIGHT CLASS	WT/LBS.	CUBIC FT.	1" TOP	1.5" TOP	GLAZE ADD	HP ADD
Z36L7EN	24 x 36 x 71.5-72	125	286.57	43.25	\$1863	\$1917	N/A	135
Z30L7EN	24 x 30 x 71.5-72	125	252.63	36.25	\$1714	\$1760	N/A	113
Z16L7EN	24 x 16 x 71.5-72	100	168.90	20.75	\$1123	\$1154	N/A	68
Z15L7EN	24 x 15 x 71.5-72	100	164.12	19.25	\$1090	\$1116	N/A	68
Z36M7EN	20 x 36 x 71.5-72	125	257.21	36.75	\$1750	\$1797	N/A	135
Z30M7EN	20 x 30 x 71.5-72	125	225.71	30.50	\$1605	\$1644	N/A	113
Z16M7EN	20 x 16 x 71.5-72	100	150.13	17.50	\$1033	\$1060	N/A	68
Z15M7EN	20 x 15 x 71.5-72	100	144.36	16.25	\$1003	\$1024	N/A	68
Z36S7EN	16 x 36 x 71.5-72	125	216.29	29.50	\$1575	\$1620	N/A	101
Z30S7EN	16 x 30 x 71.5-72	125	189.34	25	\$1427	\$1458	N/A	91
Z16S7EN	16 x 16 x 71.5-72	100	125.06	14	\$952	\$978	N/A	57
Z15S7EN	16 x 15 x 71.5-72	100	120.40	12.50	\$942	\$963	N/A	57

Three open shelves and two file drawers on bottom. **Includes two 3-position fixed/height adjustable shelves.** Lock secures all drawers. 36" and 30" wide models have front-to-back and side-to-side letter/legal filing capability. Side-to-side file bars included.

- Lateral file drawer construction is for accommodating hanging files NOT for stacking materials on the drawer bottom.



Three File Module with Doors

Z36L73F	24 x 36 x 71.5-72	125	320.25	43.25	\$2350	\$2404	\$697	N/A
Z30L73F	24 x 30 x 71.5-72	125	283.50	36.25	\$2154	\$2199	\$606	N/A
Z36M73F	20 x 36 x 71.5-72	125	290.85	36.75	\$2251	\$2297	\$697	N/A
Z30M73F	20 x 30 x 71.5-72	100	259.35	30.50	\$2055	\$2094	\$606	N/A
Z36S73F	16 x 36 x 71.5-72	100	248.85	29.50	\$2039	\$2084	\$697	N/A
Z30S73F	16 x 30 x 71.5-72	100	218.40	25	\$1850	\$1881	\$606	N/A

Three lateral file drawers on bottom. Laminate doors are standard. **Includes one 3-position fixed/height adjustable shelf.** Upper lock secures storage compartment. Lower lock secures three file drawers. Front-to-back and side-to-side letter/legal filing capability. Side-to-side file bars included.

- Lateral file drawer construction is for accommodating hanging files NOT for stacking materials on the drawer bottom.



Three File Module with Door - LEFT

Z16L73FL	24 x 16 x 71.5-72	100	187.95	20.75	\$1368	\$1399	\$343	N/A
Z15L73FL	24 x 15 x 71.5-72	100	182	19.25	\$1323	\$1349	\$302	N/A
Z16M73FL	20 x 16 x 71.5-72	100	169.05	17.50	\$1285	\$1312	\$343	N/A
Z15M73FL	20 x 15 x 71.5-72	100	161.70	16.25	\$1244	\$1265	\$302	N/A
Z16S73FL	16 x 16 x 71.5-72	92.5	142.80	14	\$1199	\$1225	\$343	N/A
Z15S73FL	16 x 15 x 71.5-72	92.5	137.55	12.50	\$1167	\$1188	\$302	N/A

Three file drawers on bottom. Laminate door is standard. **Includes one 3-position fixed/height adjustable shelf.** Upper lock secures storage compartment. Lower lock secures three file drawers.



Three File Module with Door - RIGHT

Z16L73FR	24 x 16 x 71.5-72	100	187.95	20.75	\$1368	\$1399	\$343	N/A
Z15L73FR	24 x 15 x 71.5-72	100	182	19.25	\$1323	\$1349	\$302	N/A
Z16M73FR	20 x 16 x 71.5-72	100	169.05	17.50	\$1285	\$1312	\$343	N/A
Z15M73FR	20 x 15 x 71.5-72	100	161.70	16.25	\$1244	\$1265	\$302	N/A
Z16S73FR	16 x 16 x 71.5-72	92.5	142.80	14	\$1199	\$1225	\$343	N/A
Z15S73FR	16 x 15 x 71.5-72	92.5	137.55	12.50	\$1167	\$1188	\$302	N/A

Three file drawers on bottom. Laminate door is standard. **Includes one 3-position fixed/height adjustable shelf.** Upper lock secures storage compartment. Lower lock secures three file drawers.

Required Specifications

Finishes
Top/Edge Detail
Handles

Optional Specifications

Glazing - Doors
Collator (Open Shelves)
Box Drawer Option (no upcharge)

STORAGE MODULES - 71.5" / 72" HIGH

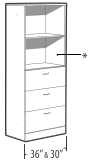

* Accepts collator 11" high

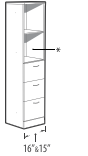

Glazed door option

Three File Module with Open Shelves

MODEL#	DIMENSIONS D x W x H	FREIGHT CLASS	WT/LBS.	CUBIC FT.	1" TOP	1.5" TOP	GLAZE ADD	HP ADD
Z36L73FN	24 x 36 x 71.5-72	125	298.75	43.25	\$2113	\$2166	N/A	N/A
Z30L73FN	24 x 30 x 71.5-72	125	266.63	36.25	\$1943	\$1989	N/A	N/A
Z16L73FN	24 x 16 x 71.5-72	100	178.75	20.75	\$1247	\$1279	N/A	N/A
Z15L73FN	24 x 15 x 71.5-72	100	172.69	19.25	\$1215	\$1241	N/A	N/A
Z36M73FN	20 x 36 x 71.5-72	125	270.44	36.75	\$2013	\$2059	N/A	N/A
Z30M73FN	20 x 30 x 71.5-72	125	241.81	30.50	\$1846	\$1884	N/A	N/A
Z16M73FN	20 x 16 x 71.5-72	100	159.98	17.50	\$1165	\$1192	N/A	N/A
Z15M73FN	20 x 15 x 71.5-72	100	153.98	16.25	\$1136	\$1157	N/A	N/A
Z36S73FN	16 x 36 x 71.5-72	125	228.47	29.50	\$1798	\$1844	N/A	N/A
Z30S73FN	16 x 30 x 71.5-72	100	201.24	25	\$1638	\$1669	N/A	N/A
Z16S73FN	16 x 16 x 71.5-72	100	133.86	14	\$1077	\$1103	N/A	N/A
Z15S73FN	16 x 15 x 71.5-72	92.5	128.97	12.50	\$1059	\$1080	N/A	N/A

Two open shelves and three file drawers on bottom. **Includes one 3-position fixed/height adjustable shelf.** Lock secures all drawers. 36" and 30" wide models have front-to-back and side-to-side letter/legal filing capability. Side-to-side file bars included.

- Lateral file drawer construction is for accommodating hanging files NOT for stacking materials on the drawer bottom.

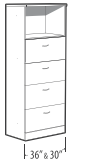

Four File Module with Open Shelf

Z36L74FN	24 x 36 x 71.5-72	125	310.80	43.25	\$2519	\$2573	N/A	N/A
Z30L74FN	24 x 30 x 71.5-72	125	277.20	36.25	\$2355	\$2401	N/A	N/A
Z16L74FN	24 x 16 x 71.5-72	100	186.90	20.75	\$1344	\$1375	N/A	N/A
Z15L74FN	24 x 15 x 71.5-72	100	180.60	19.25	\$1308	\$1333	N/A	N/A
Z36M74FN	20 x 36 x 71.5-72	125	283.50	36.75	\$2250	\$2296	N/A	N/A
Z30M74FN	20 x 30 x 71.5-72	100	255.15	30.50	\$2115	\$2153	N/A	N/A
Z16M74FN	20 x 16 x 71.5-72	100	169.05	17.50	\$1265	\$1292	N/A	N/A
Z15M74FN	20 x 15 x 71.5-72	100	161.70	16.25	\$1226	\$1247	N/A	N/A
Z36S74FN	16 x 36 x 71.5-72	100	239.40	29.50	\$2015	\$2060	N/A	N/A
Z30S74FN	16 x 30 x 71.5-72	100	212.10	25	\$1836	\$1867	N/A	N/A
Z16S74FN	16 x 16 x 71.5-72	92.5	140.70	14	\$1163	\$1189	N/A	N/A
Z15S74FN	16 x 15 x 71.5-72	92.5	135.45	12.50	\$1116	\$1137	N/A	N/A

Open shelf and four file drawers. Lock secures all drawers. 36" and 30" wide models have front-to-back and side-to-side letter/legal filing capability. Side-to-side file bars included.

- Lateral file drawer construction is for accommodating hanging files NOT for stacking materials on the drawer bottom.



Intended for working while standing

Media Center - LEFT

Z36L7MCL	24 x 36 x 71.5-72	125	294	43.25	\$1955	\$2008	N/A	N/A
Z30L7MCL	24 x 30 x 71.5-72	125	259.35	36.25	\$1781	\$1827	N/A	N/A
Z36M7MCL	20 x 36 x 71.5-72	125	261.45	36.75	\$1821	\$1867	N/A	N/A
Z30M7MCL	20 x 30 x 71.5-72	125	229.95	30.50	\$1658	\$1697	N/A	N/A
Z36S7MCL	16 x 36 x 71.5-72	125	214.20	29.50	\$1602	\$1647	N/A	N/A
Z30S7MCL	16 x 30 x 71.5-72	125	189	25	\$1451	\$1482	N/A	N/A

Unit, accommodates pc, keyboard, monitor, hanging folders and accessories and/or printer. One vertical drawer on the **left**. Pull out keyboard shelf. Adjustable pull out bottom shelf accommodates pc and/or printer. **Includes one 3-position fixed/height adjustable shelf.** Grommet in worksurface and back panel. Lock secures vertical drawer.

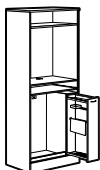

Intended for working while standing

Media Center - RIGHT

Z36L7MCR	24 x 36 x 71.5-72	125	294	43.25	\$1955	\$2008	N/A	N/A
Z30L7MCR	24 x 30 x 71.5-72	125	259.35	36.25	\$1781	\$1827	N/A	N/A
Z36M7MCR	20 x 36 x 71.5-72	125	261.45	36.75	\$1821	\$1867	N/A	N/A
Z30M7MCR	20 x 30 x 71.5-72	125	229.95	30.50	\$1658	\$1697	N/A	N/A
Z36S7MCR	16 x 36 x 71.5-72	125	214.20	29.50	\$1602	\$1647	N/A	N/A
Z30S7MCR	16 x 30 x 71.5-72	125	189	25	\$1451	\$1482	N/A	N/A

Unit, accommodates pc, keyboard, monitor, hanging folders and accessories and/or printer. One vertical drawer on the **right**. Pull out keyboard shelf. Adjustable pull out bottom shelf accommodates pc and/or printer. **Includes one 3-position fixed/height adjustable shelf.** Grommet in worksurface and back panel. Lock secures vertical drawer.

Required Specifications

- Finishes
- Top/Edge Detail
- Handles

Optional Specifications

- Glazing - Doors
- Collator (Open Shelves)
- Box Drawer Option (no upcharge)

STORAGE MODULES - 71.5" / 72" HIGH



PC Center

MODEL#	DIMENSIONS D x W x H	FREIGHT CLASS	WT/LBS.	CUBIC FT.	1" TOP	1.5" TOP	GLAZE ADD	HP ADD
Z36L7PC	24 x 36 x 71.5-72	150	255.15	43.25	\$1441	\$1494	N/A	135
Z30L7PC	24 x 30 x 71.5-72	125	221.55	36.25	\$1288	\$1334	N/A	113
Z36M7PC	20 x 36 x 71.5-72	125	226.80	36.75	\$1325	\$1371	N/A	135
Z30M7PC	20 x 30 x 71.5-72	125	197.40	30.50	\$1163	\$1202	N/A	113
Z36S7PC	16 x 36 x 71.5-72	125	187.95	29.50	\$1145	\$1190	N/A	101
Z30S7PC	16 x 30 x 71.5-72	125	162.75	25	\$1054	\$1085	N/A	91

Standing height unit, accommodates pc, keyboard, monitor and/or printer. Pull out keyboard shelf. Adjustable pull out bottom shelf accommodates pc and/or printer. **Includes one 3-position fixed/height adjustable shelf.** Grommet in worksurface and back panel.

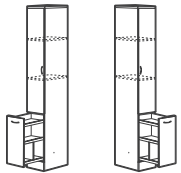

LEFT RIGHT
Vertical Utility Drawer with Door

Z12L7VDL	24 x 12 x 71.5-72	92.5	164.85	16	\$1128	\$1151	\$344	N/A
Z12M7VDL	20 x 12 x 71.5-72	92.5	147	13.25	\$1042	\$1060	\$344	N/A
Z12S7VDL	16 x 12 x 71.5-72	92.5	123.90	11	\$954	\$972	\$344	N/A
Z12L7VDR	24 x 12 x 71.5-72	92.5	164.85	16	\$1128	\$1151	\$344	N/A
Z12M7VDR	20 x 12 x 71.5-72	92.5	147	13.25	\$1042	\$1060	\$344	N/A
Z12S7VDR	16 x 12 x 71.5-72	92.5	123.90	11	\$954	\$972	\$344	N/A

Specify **VDL** models for **LEFT** or **VDR** models for **RIGHT**

Laminate doors are standard. **Includes two 3-position fixed/height adjustable shelves** and one vertical drawer. Upper lock secures storage compartment. Lower lock secures vertical drawer.

WARDROBE CABINETS - 71.5" / 72" HIGH

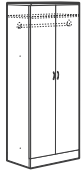

Wardrobe Cabinet

Z36L7WA	24 x 36 x 71.5-72	150	252	43.25	\$1528	\$1581	N/A	N/A
Z30L7WA	24 x 30 x 71.5-72	125	218.40	36.25	\$1427	\$1473	N/A	N/A
Z36M7WA	20 x 36 x 71.5-72	125	226.80	36.75	\$1437	\$1483	N/A	N/A
Z30M7WA	20 x 30 x 71.5-72	125	196.35	30.50	\$1275	\$1314	N/A	N/A

Laminate doors are standard. Full length hanging rod included. **Includes one 3-position fixed/height adjustable shelf** above hanging rod. Standard with lock.



Wardrobe Cabinet - LEFT

Z24L7WAL	24 x 24 x 71.5-72	125	191.10	29.75	\$1158	\$1195	N/A	N/A
Z21L7WAL	24 x 21 x 71.5-72	125	178.50	26	\$1116	\$1153	N/A	N/A
Z18L7WAL	24 x 18 x 71.5-72	125	158.55	22.75	\$1026	\$1058	N/A	N/A
Z16L7WAL	24 x 16 x 71.5-72	125	149.10	20.75	\$984	\$1015	N/A	N/A
Z15L7WAL	24 x 15 x 71.5-72	125	144.90	19.25	\$936	\$962	N/A	N/A
Z12L7WAL	24 x 12 x 71.5-72	100	130.20	16	\$872	\$893	N/A	N/A
Z24M7WAL	20 x 24 x 71.5-72	125	171.15	25.25	\$1070	\$1103	N/A	N/A
Z21M7WAL	20 x 21 x 71.5-72	125	154.35	21.25	\$1027	\$1059	N/A	N/A
Z18M7WAL	20 x 18 x 71.5-72	125	139.65	19.25	\$947	\$974	N/A	N/A
Z16M7WAL	20 x 16 x 71.5-72	125	131.25	17.50	\$905	\$932	N/A	N/A
Z15M7WAL	20 x 15 x 71.5-72	125	126	16.25	\$859	\$882	N/A	N/A
Z12M7WAL	20 x 12 x 71.5-72	100	113.40	13.25	\$805	\$823	N/A	N/A

Laminate doors are standard. Full length hanging rod included. **Includes one 3-position fixed/height adjustable shelf** above hanging rod. Standard with lock.

Required Specifications

Finishes
Top/Edge Detail
Handles

Optional Specifications

Glazing - Doors (Vertical Utility)

WARDROBE CABINETS - 71.5" / 72" HIGH

MODEL#	DIMENSIONS	FREIGHT CLASS	WT/LBS.	CUBIC FT.	1" TOP	1.5" TOP	GLAZE ADD	HP ADD
D x W x H								
Z24L7WAR	24 x 24 x 71.5-72	125	191.10	29.75	\$1158	\$1195	N/A	N/A
Z21L7WAR	24 x 21 x 71.5-72	125	178.50	26	\$1116	\$1153	N/A	N/A
Z18L7WAR	24 x 18 x 71.5-72	125	158.55	22.75	\$1026	\$1058	N/A	N/A
Z16L7WAR	24 x 16 x 71.5-72	125	149.10	20.75	\$984	\$1015	N/A	N/A
Z15L7WAR	24 x 15 x 71.5-72	125	144.90	19.25	\$936	\$962	N/A	N/A
Z12L7WAR	24 x 12 x 71.5-72	100	130.20	16	\$872	\$893	N/A	N/A
Z24M7WAR	20 x 24 x 71.5-72	125	171.15	25.25	\$1070	\$1103	N/A	N/A
Z21M7WAR	20 x 21 x 71.5-72	125	154.35	21.25	\$1027	\$1059	N/A	N/A
Z18M7WAR	20 x 18 x 71.5-72	125	139.65	19.25	\$947	\$974	N/A	N/A
Z16M7WAR	20 x 16 x 71.5-72	125	131.25	17.50	\$905	\$932	N/A	N/A
Z15M7WAR	20 x 15 x 71.5-72	125	126	16.25	\$859	\$882	N/A	N/A
Z12M7WAR	20 x 12 x 71.5-72	100	113.40	13.25	\$805	\$823	N/A	N/A

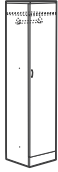

Wardrobe Cabinet - RIGHT

Laminate doors are standard. Full length hanging rod included. **Includes one 3-position fixed/height adjustable shelf** above hanging rod. Standard with lock.

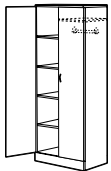

Glazed door option

Wardrobe Cabinet/Shelving Combo with Doors - LEFT

Z36L7DIL	24 x 36 x 71.5-72	125	300.30	43.25	\$1802	\$1856	\$1126	N/A
Z30L7DIL	24 x 30 x 71.5-72	125	262.50	36.25	\$1575	\$1621	\$973	N/A
Z24L7DIL	24 x 24 x 71.5-72	125	232.05	29.75	\$1433	\$1470	\$876	N/A
Z21L7DIL	24 x 21 x 71.5-72	125	200.55	26	\$1391	\$1427	\$869	N/A
Z36M7DIL	20 x 36 x 71.5-72	125	276.15	36.75	\$1692	\$1738	\$1126	N/A
Z30M7DIL	20 x 30 x 71.5-72	125	241.50	30.50	\$1468	\$1507	\$973	N/A
Z24M7DIL	20 x 24 x 71.5-72	100	214.20	25.25	\$1347	\$1379	\$876	N/A
Z21M7DIL	20 x 21 x 71.5-72	100	196.35	21.25	\$1293	\$1325	\$869	N/A

Laminate doors are standard. Storage compartment on **left includes four 3-position fixed/height adjustable shelves**. Wardrobe compartment on **right** includes hanging rod and one adjustable shelf above rod. Single lock secures storage and wardrobe compartments.

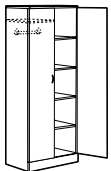

Glazed door option

Wardrobe Cabinet/Shelving Combo with Doors - RIGHT

Z36L7DIR	24 x 36 x 71.5-72	125	300.30	43.25	\$1802	\$1856	\$1126	N/A
Z30L7DIR	24 x 30 x 71.5-72	125	262.50	36.25	\$1575	\$1621	\$973	N/A
Z24L7DIR	24 x 24 x 71.5-72	125	232.05	29.75	\$1433	\$1470	\$876	N/A
Z21L7DIR	24 x 21 x 71.5-72	125	200.55	26	\$1391	\$1427	\$869	N/A
Z36M7DIR	20 x 36 x 71.5-72	125	276.15	36.75	\$1692	\$1738	\$1126	N/A
Z30M7DIR	20 x 30 x 71.5-72	125	241.50	30.50	\$1468	\$1507	\$973	N/A
Z24M7DIR	20 x 24 x 71.5-72	100	214.20	25.25	\$1347	\$1379	\$876	N/A
Z21M7DIR	20 x 21 x 71.5-72	100	196.35	21.25	\$1293	\$1325	\$869	N/A

Laminate doors are standard. Storage compartment on **right includes four 3-position fixed/height adjustable shelves**. Wardrobe compartment on **left** includes hanging rod and one adjustable shelf above rod. Single lock secures storage and wardrobe compartments.

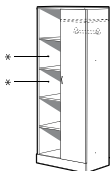

Glazed door option * Accepts collator 11" high

Wardrobe Cabinet/Open Shelving Combo - LEFT

Z36L7DINL	24 x 36 x 71.5-72	125	277.47	43.25	\$1626	\$1680	\$561	N/A
Z30L7DINL	24 x 30 x 71.5-72	125	244.53	36.25	\$1431	\$1477	\$485	N/A
Z24L7DINL	24 x 24 x 71.5-72	125	217.88	29.75	\$1302	\$1339	\$435	N/A
Z21L7DINL	24 x 21 x 71.5-72	125	189.33	26	\$1259	\$1296	\$431	N/A
Z36M7DINL	20 x 36 x 71.5-72	125	254.41	36.75	\$1515	\$1561	\$561	N/A
Z30M7DINL	20 x 30 x 71.5-72	125	222.86	30.50	\$1323	\$1362	\$485	N/A
Z24M7DINL	20 x 24 x 71.5-72	100	202.22	25.25	\$1215	\$1247	\$435	N/A
Z21M7DINL	20 x 21 x 71.5-72	100	183.93	21.25	\$1163	\$1195	\$431	N/A

Laminate door is standard on wardrobe section. Storage compartment on **left includes four 3-position fixed/height adjustable shelves**. Wardrobe compartment on **right** includes hanging rod and one adjustable shelf above rod. Single lock secures storage and wardrobe compartments.

Required Specifications

Finishes
Top/Edge Detail
Handles

Optional Specifications

Glazing - Doors
Collator (Open Shelves)

WARDROBE CABINETS - 71.5" / 72" HIGH

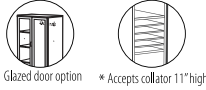
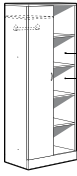

Wardrobe Cabinet/Open Shelving Combo - RIGHT

MODEL#	DIMENSIONS D x W x H	FREIGHT CLASS	WT/LBS.	CUBIC FT.	1" TOP	1.5" TOP	GLAZE ADD	HP ADD
Z36L7DINR	24 x 36 x 71.5-72	125	277.47	43.25	\$1626	\$1680	\$561	N/A
Z30L7DINR	24 x 30 x 71.5-72	125	244.53	36.25	\$1431	\$1477	\$485	N/A
Z24L7DINR	24 x 24 x 71.5-72	125	217.88	29.75	\$1302	\$1339	\$435	N/A
Z21L7DINR	24 x 21 x 71.5-72	125	189.33	26	\$1259	\$1296	\$431	N/A
Z36M7DINR	20 x 36 x 71.5-72	125	254.41	36.75	\$1515	\$1561	\$561	N/A
Z30M7DINR	20 x 30 x 71.5-72	125	222.86	30.50	\$1323	\$1362	\$485	N/A
Z24M7DINR	20 x 24 x 71.5-72	100	202.22	25.25	\$1215	\$1247	\$435	N/A
Z21M7DINR	20 x 21 x 71.5-72	100	183.93	21.25	\$1163	\$1195	\$431	N/A

Laminate door is standard on wardrobe section. Storage compartment on **right includes four 3-position fixed/height adjustable shelves**. Wardrobe compartment on **left** includes hanging rod and one adjustable shelf above rod. Single lock secures storage and wardrobe compartments.

PERSONAL TOWERS - 71.5" / 72" HIGH

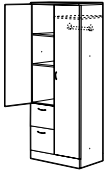

Personal Tower with Doors - LEFT

Z36L7EL	24 x 36 x 71.5-72	125	324.45	43.25	\$1974	\$2027	\$999	N/A
Z30L7EL	24 x 30 x 71.5-72	125	289.80	36.25	\$1812	\$1858	\$916	N/A
Z24L7EL	24 x 24 x 71.5-72	100	260.76	29.75	\$1726	\$1764	\$810	N/A
Z36M7EL	20 x 36 x 71.5-72	125	288.75	36.75	\$1847	\$1894	\$999	N/A
Z30M7EL	20 x 30 x 71.5-72	100	259.35	30.50	\$1694	\$1733	\$916	N/A
Z24M7EL	20 x 24 x 71.5-72	100	231.65	25.25	\$1612	\$1644	\$810	N/A

Two file drawers on bottom. Laminate doors are standard. Storage compartment on **left includes two 3-position fixed/height adjustable shelves**. Wardrobe compartment on **right** includes hanging rod and one adjustable shelf above rod. Upper lock secures storage and wardrobe compartments. Lower lock secures all drawers.

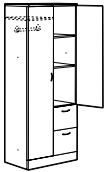

Personal Tower with Doors - RIGHT

Z36L7ER	24 x 36 x 71.5-72	125	324.45	43.25	\$1974	\$2027	\$999	N/A
Z30L7ER	24 x 30 x 71.5-72	125	289.80	36.25	\$1812	\$1858	\$916	N/A
Z24L7ER	24 x 24 x 71.5-72	100	260.76	29.75	\$1726	\$1764	\$810	N/A
Z36M7ER	20 x 36 x 71.5-72	125	288.75	36.75	\$1847	\$1894	\$999	N/A
Z30M7ER	20 x 30 x 71.5-72	100	259.35	30.50	\$1694	\$1733	\$916	N/A
Z24M7ER	20 x 24 x 71.5-72	100	231.65	25.25	\$1612	\$1644	\$810	N/A

Two file drawers on bottom. Laminate doors are standard. Storage compartment on **right includes two 3-position fixed/height adjustable shelves**. Wardrobe compartment on **left** includes hanging rod and one adjustable shelf above rod. Upper lock secures storage and wardrobe compartments. Lower lock secures all drawers.

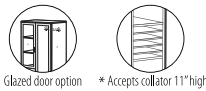
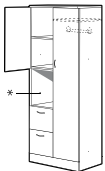

Personal Tower with Doors and cavity - LEFT

Z36L7ECL	24 x 36 x 71.5-72	125	320.24	43.25	\$1963	\$2017	\$907	N/A
Z30L7ECL	24 x 30 x 71.5-72	125	287.34	36.25	\$1800	\$1846	\$824	N/A
Z24L7ECL	24 x 24 x 71.5-72	100	257.23	29.75	\$1707	\$1744	\$718	N/A
Z36M7ECL	20 x 36 x 71.5-72	125	285.63	36.75	\$1817	\$1863	\$907	N/A
Z30M7ECL	20 x 30 x 71.5-72	100	256.22	30.50	\$1665	\$1703	\$824	N/A
Z24M7ECL	20 x 24 x 71.5-72	100	228.11	25.25	\$1582	\$1614	\$718	N/A

Two file drawers on bottom. Laminate doors are standard. Storage compartment on **left includes one 3-position fixed/height adjustable shelf**. Wardrobe compartment on **right** includes hanging rod and one adjustable shelf above rod. Upper lock secures storage and wardrobe compartments. Lower lock secures all drawers.

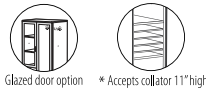
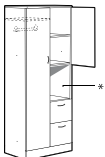

Personal Tower with Doors and cavity - RIGHT

Z36L7ECL	24 x 36 x 71.5-72	125	320.24	43.25	\$1963	\$2017	\$907	N/A
Z30L7ECL	24 x 30 x 71.5-72	125	287.34	36.25	\$1800	\$1846	\$824	N/A
Z24L7ECL	24 x 24 x 71.5-72	100	257.23	29.75	\$1707	\$1744	\$718	N/A
Z36M7ECL	20 x 36 x 71.5-72	125	285.63	36.75	\$1817	\$1863	\$907	N/A
Z30M7ECL	20 x 30 x 71.5-72	100	256.22	30.50	\$1665	\$1703	\$824	N/A
Z24M7ECL	20 x 24 x 71.5-72	100	228.11	25.25	\$1582	\$1614	\$718	N/A

Two file drawers on bottom. Laminate doors are standard. Storage compartment on **left includes one 3-position fixed/height adjustable shelf**. Wardrobe compartment on **right** includes hanging rod and one adjustable shelf above rod. Upper lock secures storage and wardrobe compartments. Lower lock secures all drawers.

Required Specifications

Finishes
Top/Edge Detail
Handles

Optional Specifications

Glazing - Doors
Collator (Open Shelves)
Box Drawer Option (no upcharge)

PERSONAL TOWERS - 71.5" / 72" HIGH

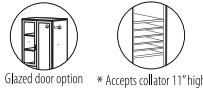
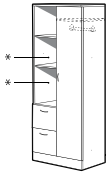

Personal Tower with Open Shelves - LEFT

MODEL#	DIMENSIONS D x W x H	FREIGHT CLASS	WT/LBS.	CUBIC FT.	1" TOP	1.5" TOP	GLAZE ADD	HP ADD
Z36L7ENL	24 x 36 x 71.5-72	125	309.60	43.25	\$1865	\$1919	\$565	N/A
Z30L7ENL	24 x 30 x 71.5-72	125	278.48	36.25	\$1704	\$1750	\$481	N/A
Z24L7ENL	24 x 24 x 71.5-72	100	247.90	29.75	\$1619	\$1656	\$376	N/A
Z36M7ENL	20 x 36 x 71.5-72	125	274.99	36.75	\$1729	\$1775	\$565	N/A
Z30M7ENL	20 x 30 x 71.5-72	100	247.36	30.50	\$1577	\$1616	\$481	N/A
Z24M7ENL	20 x 24 x 71.5-72	100	218.79	25.25	\$1504	\$1537	\$376	N/A

Two file drawers on bottom. Laminate door is standard on wardrobe section. Storage compartment on **left** includes **two 3-position fixed/height adjustable shelves**. Wardrobe compartment on **right** includes hanging rod and one adjustable shelf above rod. Upper lock secures storage and wardrobe compartments. Lower lock secures all drawers.

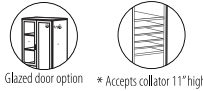
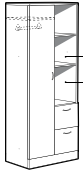

Personal Tower with Open Shelves - RIGHT

Z36L7ENR	24 x 36 x 71.5-72	125	309.60	43.25	\$1865	\$1919	\$565	N/A
Z30L7ENR	24 x 30 x 71.5-72	125	278.48	36.25	\$1704	\$1750	\$481	N/A
Z24L7ENR	24 x 24 x 71.5-72	100	247.90	29.75	\$1619	\$1656	\$376	N/A
Z36M7ENR	20 x 36 x 71.5-72	125	274.99	36.75	\$1729	\$1775	\$565	N/A
Z30M7ENR	20 x 30 x 71.5-72	100	247.36	30.50	\$1577	\$1616	\$481	N/A
Z24M7ENR	20 x 24 x 71.5-72	100	218.79	25.25	\$1504	\$1537	\$376	N/A

Two file drawers on bottom. Laminate door is standard on wardrobe section. Storage compartment on **right** includes **two 3-position fixed/height adjustable shelves**. Wardrobe compartment on **left** includes hanging rod and one adjustable shelf above rod. Upper lock secures storage and wardrobe compartments. Lower lock secures all drawers.

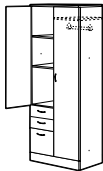

Personal Tower with Doors - LEFT

Z36L7BFL	24 x 36 x 71.5-72	125	326.55	43.25	\$2074	\$2127	\$999	N/A
Z30L7BFL	24 x 30 x 71.5-72	100	292.95	36.25	\$1916	\$1962	\$916	N/A
Z24L7BFL	24 x 24 x 71.5-72	100	262.10	29.75	\$1802	\$1839	\$810	N/A
Z36M7BFL	20 x 36 x 71.5-72	125	291.90	36.75	\$1945	\$1991	\$999	N/A
Z30M7BFL	20 x 30 x 71.5-72	100	262.50	30.50	\$1815	\$1853	\$863	N/A
Z24M7BFL	20 x 24 x 71.5-72	100	232.98	25.25	\$1688	\$1720	\$810	N/A

Two box and one file drawer on bottom. Laminate doors are standard. Storage compartment on **left** includes **two 3-position fixed/height adjustable shelves**. Wardrobe compartment on **right** includes hanging rod and one adjustable shelf above rod. Upper lock secures storage and wardrobe compartments. Lower lock secures all drawers.



Personal Tower with Doors - RIGHT

Z36L7BFR	24 x 36 x 71.5-72	125	326.55	43.25	\$2074	\$2127	\$999	N/A
Z30L7BFR	24 x 30 x 71.5-72	100	292.95	36.25	\$1916	\$1962	\$916	N/A
Z24L7BFR	24 x 24 x 71.5-72	100	262.10	29.75	\$1802	\$1839	\$810	N/A
Z36M7BFR	20 x 36 x 71.5-72	125	291.90	36.75	\$1945	\$1991	\$999	N/A
Z30M7BFR	20 x 30 x 71.5-72	100	262.50	30.50	\$1815	\$1853	\$863	N/A
Z24M7BFR	20 x 24 x 71.5-72	100	232.98	25.25	\$1688	\$1720	\$810	N/A

Two box and one file drawer on bottom. Laminate doors are standard. Storage compartment on **right** includes **two 3-position fixed/height adjustable shelves**. Wardrobe compartment on **left** includes hanging rod and one adjustable shelf above rod. Upper lock secures storage and wardrobe compartments. Lower lock secures all drawers.

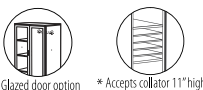
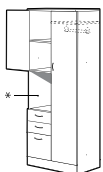

Personal Tower with Doors and Cavity - LEFT

Z36L7BFCL	24 x 36 x 71.5-72	125	317.68	43.25	\$2052	\$2084	\$907	N/A
Z30L7BFCL	24 x 30 x 71.5-72	125	287	36.25	\$1895	\$1921	\$824	N/A
Z24L7BFCL	24 x 24 x 71.5-72	100	258.59	29.75	\$1773	\$1810	\$718	N/A
Z36M7BFCL	20 x 36 x 71.5-72	125	288.78	36.75	\$1909	\$1955	\$907	N/A
Z30M7BFCL	20 x 30 x 71.5-72	100	259.37	30.50	\$1778	\$1817	\$824	N/A
Z24M7BFCL	20 x 24 x 71.5-72	100	229.45	25.25	\$1657	\$1689	\$718	N/A

Two box and one file drawer on bottom. Laminate doors are standard. Storage compartment on **left** includes **one 3-position fixed/height adjustable shelves**. Wardrobe compartment on **right** includes hanging rod and one adjustable shelf above rod. Upper lock secures storage and wardrobe compartments. Lower lock secures all drawers.

Required Specifications

Finishes
Top/Edge Detail
Handles

Optional Specifications

Glazing - Doors
Collator (Open Shelves)
Box Drawer Option (no upcharge)

PERSONAL TOWERS - 71.5" / 72" HIGH

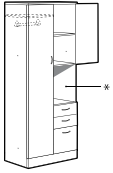

Glazed door option

* Accepts collator 11" high

Personal Tower with Doors and Cavity - RIGHT

MODEL#	DIMENSIONS D x W x H	FREIGHT CLASS	WT./LBS.	CUBIC FT.	1" TOP	1.5" TOP	GLAZE ADD	HP ADD
Z36L7BFCR	24 x 36 x 71.5-72	125	317.68	43.25	\$2052	\$2084	\$907	N/A
Z30L7BFCR	24 x 30 x 71.5-72	125	287	36.25	\$1895	\$1921	\$824	N/A
Z24L7BFCR	24 x 24 x 71.5-72	100	258.59	29.75	\$1773	\$1810	\$718	N/A
Z36M7BFCR	20 x 36 x 71.5-72	125	288.78	36.75	\$1909	\$1955	\$907	N/A
Z30M7BFCR	20 x 30 x 71.5-72	100	259.37	30.50	\$1778	\$1817	\$824	N/A
Z24M7BFCR	20 x 24 x 71.5-72	100	229.45	25.25	\$1657	\$1689	\$718	N/A

Two box and one file drawer on bottom. Laminate doors are standard. Storage compartment on **left** includes **one 3-position fixed/height adjustable shelves** Wardrobe compartment on **right** includes hanging rod and one adjustable shelf above rod. Upper lock secures storage and wardrobe compartments. Lower lock secures all drawers.

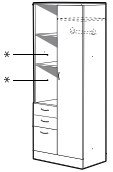

Glazed door option

* Accepts collator 11" high

Personal Tower with Open Shelves - LEFT

Z36L7BFNL	24 x 36 x 71.5-72	125	309	43.25	\$1957	\$1992	\$565	N/A
Z30L7BFNL	24 x 30 x 71.5-72	125	277	36.25	\$1797	\$1824	\$481	N/A
Z24L7BFNL	24 x 24 x 71.5-72	100	249.24	29.75	\$1654	\$1691	\$376	N/A
Z36M7BFNL	20 x 36 x 71.5-72	125	274	36.75	\$1809	\$1856	\$565	N/A
Z30M7BFNL	20 x 30 x 71.5-72	100	246	30.50	\$1677	\$1716	\$481	N/A
Z24M7BFNL	20 x 24 x 71.5-72	100	220.12	25.25	\$1540	\$1572	\$376	N/A

Two box and one file drawer on bottom. Laminate doors are standard. Storage compartment on **left** includes **two 3-position fixed/height adjustable shelves**. Wardrobe compartment on **right** includes hanging rod and **one adjustable shelf** above rod. Upper lock secures storage and wardrobe compartments. Lower lock secures all drawers.

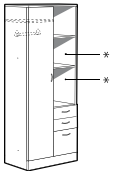

Glazed door option

* Accepts collator 11" high

Personal Tower with Open Shelves - RIGHT

Z36L7BFNR	24 x 36 x 71.5-72	125	309	43.25	\$1957	\$1992	\$565	N/A
Z30L7BFNR	24 x 30 x 71.5-72	125	277	36.25	\$1797	\$1824	\$481	N/A
Z24L7BFNR	24 x 24 x 71.5-72	100	249.24	29.75	\$1654	\$1691	\$376	N/A
Z36M7BFNR	20 x 36 x 71.5-72	125	274	36.75	\$1809	\$1856	\$565	N/A
Z30M7BFNR	20 x 30 x 71.5-72	100	246	30.50	\$1677	\$1716	\$481	N/A
Z24M7BFNR	20 x 24 x 71.5-72	100	220.12	25.25	\$1540	\$1572	\$376	N/A

Two box and one file drawer on bottom. Laminate doors are standard. Storage compartment on **right** includes **two 3-position fixed/height adjustable shelves**. Wardrobe compartment on **left** includes hanging rod and **one adjustable shelf** above rod. Upper lock secures storage and wardrobe compartments. Lower lock secures all drawers.

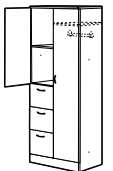

Glazed door option

Personal Tower with Doors - LEFT

Z36L73FL	24 x 36 x 71.5-72	125	329.70	43.25	\$2079	\$2133	\$907	N/A
Z30L73FL	24 x 30 x 71.5-72	100	295.05	36.25	\$1927	\$1973	\$824	N/A
Z24L73FL	24 x 24 x 71.5-72	100	264.77	29.75	\$1797	\$1835	\$718	N/A
Z36M73FL	20 x 36 x 71.5-72	100	296.10	36.75	\$1970	\$2016	\$907	N/A
Z30M73FL	20 x 30 x 71.5-72	100	266.70	30.50	\$1818	\$1856	\$824	N/A
Z24M73FL	20 x 24 x 71.5-72	100	237.97	25.25	\$1687	\$1720	\$718	N/A

Three file drawers on bottom. Laminate doors are standard. Storage compartment on **left** includes **one 3-position fixed/height adjustable shelf**. Wardrobe compartment on **right** includes hanging rod and **one adjustable shelf** above rod. Upper lock secures storage and wardrobe compartments. Lower lock secures all drawers.

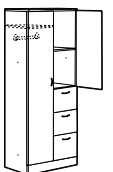

Glazed door option

Personal Tower with Doors - RIGHT

Z36L73FR	24 x 36 x 71.5-72	125	329.70	43.25	\$2079	\$2133	\$907	N/A
Z30L73FR	24 x 30 x 71.5-72	100	295.05	36.25	\$1927	\$1973	\$824	N/A
Z24L73FR	24 x 24 x 71.5-72	100	264.77	29.75	\$1797	\$1835	\$718	N/A
Z36M73FR	20 x 36 x 71.5-72	100	296.10	36.75	\$1970	\$2016	\$907	N/A
Z30M73FR	20 x 30 x 71.5-72	100	266.70	30.50	\$1818	\$1856	\$824	N/A
Z24M73FR	20 x 24 x 71.5-72	100	237.97	25.25	\$1687	\$1720	\$718	N/A

Three file drawers on bottom. Laminate doors are standard. Storage compartment on **right** includes **one 3-position fixed/height adjustable shelf**. Wardrobe compartment on **left** includes hanging rod and **one adjustable shelf** above rod. Upper lock secures storage and wardrobe compartments. Lower lock secures all drawers.

Required Specifications

Finishes
Top/Edge Detail
Handles

Optional Specifications

Glazing - Doors
Collator (Open Shelves)
Box Drawer Option (no upcharge)

PERSONAL TOWERS - 71.5" / 72" HIGH

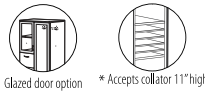
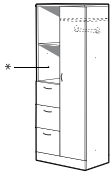

Personal Tower with Open Shelves - LEFT

MODEL#	DIMENSIONS D x W x H	FREIGHT CLASS	WT/LBS.	CUBIC FT.	1" TOP	1.5" TOP	GLAZE ADD	HP ADD
Z36L73FNL	24 x 36 x 71.5-72	125	318.84	43.25	\$1974	\$2028	\$565	N/A
Z30L73FNL	24 x 30 x 71.5-72	125	287.05	36.25	\$1822	\$1868	\$481	N/A
Z24L73FNL	24 x 24 x 71.5-72	100	256.34	29.75	\$1679	\$1716	\$376	N/A
Z36M73FNL	20 x 36 x 71.5-72	125	286.33	36.75	\$1865	\$1911	\$565	N/A
Z30M73FNL	20 x 30 x 71.5-72	100	258.03	30.50	\$1712	\$1751	\$481	N/A
Z24M73FNL	20 x 24 x 71.5-72	100	228.38	25.25	\$1569	\$1602	\$376	N/A

Three file drawers on bottom. Laminate door is standard on wardrobe section. Storage compartment on **left includes one 3-position fixed/height adjustable shelf**. Wardrobe compartment on **right** includes hanging rod and **one 3-position fixed/height adjustable shelf** above rod. Upper lock secures storage and wardrobe compartments. Lower lock secures all drawers.

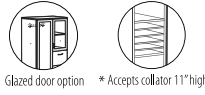
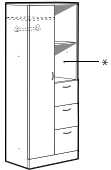

Personal Tower with Open Shelves - RIGHT

Z36L73FNR	24 x 36 x 71.5-72	125	318.84	43.25	\$1974	\$2028	\$565	N/A
Z30L73FNR	24 x 30 x 71.5-72	125	287.05	36.25	\$1822	\$1868	\$481	N/A
Z24L73FNR	24 x 24 x 71.5-72	100	256.34	29.75	\$1679	\$1716	\$376	N/A
Z36M73FNR	20 x 36 x 71.5-72	125	286.33	36.75	\$1865	\$1911	\$565	N/A
Z30M73FNR	20 x 30 x 71.5-72	100	258.03	30.50	\$1712	\$1751	\$481	N/A
Z24M73FNR	20 x 24 x 71.5-72	100	228.38	25.25	\$1569	\$1602	\$376	N/A

Three file drawers on bottom. Laminate door is standard on wardrobe section. Storage compartment on **right includes one 3-position fixed/height adjustable shelf**. Wardrobe compartment on **left** includes hanging rod and **one 3-position fixed/height adjustable shelf** above rod. Upper lock secures storage and wardrobe compartments. Lower lock secures all drawers.

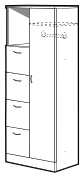

Personal Tower with Open Shelf - LEFT

Z36L74FNL	24 x 36 x 71.5-72	125	329.70	43.25	\$2035	\$2088	\$565	N/A
Z30L74FNL	24 x 30 x 71.5-72	100	290.85	36.25	\$1897	\$1943	\$481	N/A
Z24L74FNL	24 x 24 x 71.5-72	100	264.77	29.75	\$1781	\$1818	\$376	N/A
Z36M74FNL	20 x 36 x 71.5-72	100	296.10	36.75	\$1953	\$2000	\$565	N/A
Z30M74FNL	20 x 30 x 71.5-72	100	266.70	30.50	\$1800	\$1839	\$481	N/A
Z24M74FNL	20 x 24 x 71.5-72	100	237.97	25.25	\$1675	\$1707	\$376	N/A

Four file drawers on bottom. Laminate door is standard on wardrobe section. Storage compartment on **left includes one 3-position fixed/height adjustable shelf**. Wardrobe compartment on **right** includes hanging rod and **one 3-position fixed/height adjustable shelf** above rod. Upper lock secures storage and wardrobe compartments. Lower lock secures all drawers.

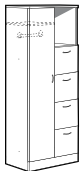

Personal Tower with Open Shelf - RIGHT

Z36L74FNR	24 x 36 x 71.5-72	125	329.70	43.25	\$2035	\$2088	\$565	N/A
Z30L74FNR	24 x 30 x 71.5-72	100	290.85	36.25	\$1897	\$1943	\$481	N/A
Z24L74FNR	24 x 24 x 71.5-72	100	264.77	29.75	\$1781	\$1818	\$376	N/A
Z36M74FNR	20 x 36 x 71.5-72	100	296.10	36.75	\$1953	\$2000	\$565	N/A
Z30M74FNR	20 x 30 x 71.5-72	100	266.70	30.50	\$1800	\$1839	\$481	N/A
Z24M74FNR	20 x 24 x 71.5-72	100	237.97	25.25	\$1675	\$1707	\$376	N/A

Four file drawers on bottom. Laminate door is standard on wardrobe section. Storage compartment on **right includes one 3-position fixed/height adjustable shelf**. Wardrobe compartment on **left** includes hanging rod and **one 3-position fixed/height adjustable shelf** above rod. Upper lock secures storage and wardrobe compartments. Lower lock secures all drawers.

STORAGE MODULES - 84" / 84.5" HIGH

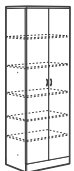

Storage Cabinet with Doors

Z36L8SH	24 x 36 x 84-84.5	125	332.85	50	\$1924	\$1978	\$1369	N/A
Z30L8SH	24 x 30 x 84-84.5	125	290.85	42	\$1706	\$1752	\$1171	N/A
Z36M8SH	20 x 36 x 84-84.5	125	299.25	42.25	\$1774	\$1820	\$1369	N/A
Z30M8SH	20 x 30 x 84-84.5	125	259.35	35.50	\$1586	\$1625	\$1171	N/A
Z36S8SH	16 x 36 x 84-84.5	125	259.35	34	\$1598	\$1643	\$1369	N/A
Z30S8SH	16 x 30 x 84-84.5	125	224.70	29	\$1424	\$1456	\$1171	N/A

Laminate doors are standard. **Includes five 3-position fixed/height adjustable shelves**. Standard with lock.

Required Specifications

Finishes
Top/Edge Detail
Handles

Optional Specifications

Glazing - Doors
Collator (Open Shelves)
Box Drawer Option (no upcharge)

STORAGE MODULES - 84" / 84.5" HIGH

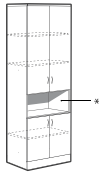

Glazed door option



* Accepts collator 11" high

Storage Cabinet with Doors and Cavity

MODEL#	DIMENSIONS D x W x H	FREIGHT CLASS	WT./LBS.	CUBIC FT.	1" TOP	1.5" TOP	GLAZE ADD	HP ADD
Z36L8SHC	24 x 36 x 84-84.5	125	326.75	50	\$1962	\$2016	\$1448	N/A
Z30L8SHC	24 x 30 x 84-84.5	125	285.07	42	\$1757	\$1803	\$1268	N/A
Z36M8SHC	20 x 36 x 84-84.5	125	291.09	42.25	\$1821	\$1868	\$1448	N/A
Z30M8SHC	20 x 30 x 84-84.5	125	252.90	35.50	\$1638	\$1677	\$1268	N/A
Z36S8SHC	16 x 36 x 84-84.5	125	252.27	34	\$1646	\$1691	\$1448	N/A
Z30S8SHC	16 x 30 x 84-84.5	125	218.63	29	\$1477	\$1508	\$1268	N/A

Laminate doors are standard. **Includes three 3-position fixed/height adjustable shelves.** Upper and lower locks secure both compartments.

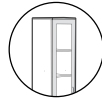

Glazed door option

Storage Cabinet with Door - LEFT

Z21L8SHL	24 x 21 x 84-84.5	125	226.80	30.25	\$1392	\$1429	\$764	N/A
Z18L8SHL	24 x 18 x 84-84.5	125	205.80	26.25	\$1309	\$1341	\$681	N/A
Z16L8SHL	24 x 16 x 84-84.5	125	186.90	24	\$1229	\$1260	\$677	N/A
Z15L8SHL	24 x 15 x 84-84.5	100	181.65	22.50	\$1212	\$1238	\$582	N/A
Z12L8SHL	24 x 12 x 84-84.5	100	163.80	18.50	\$1129	\$1150	\$519	N/A
Z21M8SHL	20 x 21 x 84-84.5	125	201.60	25.50	\$1257	\$1288	\$764	N/A
Z18M8SHL	20 x 18 x 84-84.5	100	180.60	22.25	\$1203	\$1230	\$681	N/A
Z16M8SHL	20 x 16 x 84-84.5	100	169.05	20.25	\$1129	\$1156	\$677	N/A
Z15M8SHL	20 x 15 x 84-84.5	100	162.75	19	\$1080	\$1101	\$582	N/A
Z12M8SHL	20 x 12 x 84-84.5	100	144.90	15.75	\$1001	\$1019	\$519	N/A
Z21S8SHL	16 x 21 x 84-84.5	100	172.20	21	\$1148	\$1173	\$764	N/A
Z18S8SHL	16 x 18 x 84-84.5	100	154.35	18	\$1074	\$1100	\$681	N/A
Z16S8SHL	16 x 16 x 84-84.5	100	142.80	16.50	\$1007	\$1033	\$677	N/A
Z15S8SHL	16 x 15 x 84-84.5	100	137.55	15.50	\$960	\$980	\$582	N/A
Z12S8SHL	16 x 12 x 84-84.5	100	120.75	13	\$886	\$903	\$519	N/A

Laminate doors are standard. **Includes five 3-position fixed/height adjustable shelves.** Standard with lock.



Glazed door option

Storage Cabinet with Door - RIGHT

Z21L8SHR	24 x 21 x 84-84.5	125	226.80	30.25	\$1392	\$1429	\$764	N/A
Z18L8SHR	24 x 18 x 84-84.5	125	205.80	26.25	\$1309	\$1341	\$681	N/A
Z16L8SHR	24 x 16 x 84-84.5	125	186.90	24	\$1229	\$1260	\$677	N/A
Z15L8SHR	24 x 15 x 84-84.5	100	181.65	22.50	\$1212	\$1238	\$582	N/A
Z12L8SHR	24 x 12 x 84-84.5	100	163.80	18.50	\$1129	\$1150	\$519	N/A
Z21M8SHR	20 x 21 x 84-84.5	125	201.60	25.50	\$1257	\$1288	\$764	N/A
Z18M8SHR	20 x 18 x 84-84.5	100	180.60	22.25	\$1203	\$1230	\$681	N/A
Z16M8SHR	20 x 16 x 84-84.5	100	169.05	20.25	\$1129	\$1156	\$677	N/A
Z15M8SHR	20 x 15 x 84-84.5	100	162.75	19	\$1080	\$1101	\$582	N/A
Z12M8SHR	20 x 12 x 84-84.5	100	144.90	15.75	\$1001	\$1019	\$519	N/A
Z21S8SHR	16 x 21 x 84-84.5	100	172.20	21	\$1148	\$1173	\$764	N/A
Z18S8SHR	16 x 18 x 84-84.5	100	154.35	18	\$1074	\$1100	\$681	N/A
Z16S8SHR	16 x 16 x 84-84.5	100	142.80	16.50	\$1007	\$1033	\$677	N/A
Z15S8SHR	16 x 15 x 84-84.5	100	137.55	15.50	\$960	\$980	\$582	N/A
Z12S8SHR	16 x 12 x 84-84.5	100	120.75	13	\$886	\$903	\$519	N/A

Laminate doors are standard. **Includes five 3-position fixed/height adjustable shelves.** Standard with lock.

Required Specifications

Finishes
Top/Edge Detail
Handles

Optional Specifications

Glazing - Doors
Collator (Open Shelves)

STORAGE MODULES - 84" / 84.5" HIGH

MODEL#	DIMENSIONS	FREIGHT CLASS	WT/LBS.	CUBIC FT.	1" TOP	1.5" TOP	GLAZE ADD	HP ADD
D x W x H								
Z21L8SHCL	24 x 21 x 84-84.5	125	223.07	30.25	\$1419	\$1456	\$793	N/A
Z18L8SHCL	24 x 18 x 84-84.5	125	202.75	26.25	\$1336	\$1368	\$717	N/A
Z16L8SHCL	24 x 16 x 84-84.5	125	185.71	24	\$1253	\$1285	\$707	N/A
Z15L8SHCL	24 x 15 x 84-84.5	125	179.28	22.50	\$1241	\$1267	\$626	N/A
Z12L8SHCL	24 x 12 x 84-84.5	100	162.12	18.50	\$1113	\$1134	\$565	N/A
Z21M8SHCL	20 x 21 x 84-84.5	125	196.66	25.50	\$1278	\$1310	\$793	N/A
Z18M8SHCL	20 x 18 x 84-84.5	125	177.57	22.25	\$1230	\$1257	\$717	N/A
Z16M8SHCL	20 x 16 x 84-84.5	100	165.89	20.25	\$1155	\$1182	\$707	N/A
Z15M8SHCL	20 x 15 x 84-84.5	100	159.52	19	\$1107	\$1130	\$626	N/A
Z12M8SHCL	20 x 12 x 84-84.5	100	141.48	15.75	\$1028	\$1046	\$565	N/A
Z21S8SHCL	16 x 21 x 84-84.5	100	168.16	21	\$1174	\$1200	\$793	N/A
Z18S8SHCL	16 x 18 x 84-84.5	100	150.29	18	\$1101	\$1127	\$717	N/A
Z16S8SHCL	16 x 16 x 84-84.5	100	139.77	16.50	\$1034	\$1060	\$707	N/A
Z15S8SHCL	16 x 15 x 84-84.5	100	134.51	15.50	\$987	\$1008	\$626	N/A
Z12S8SHCL	16 x 12 x 84-84.5	100	117.69	13	\$912	\$930	\$565	N/A

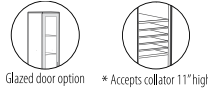
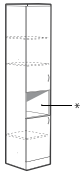

Storage Cabinet with Doors and Cavity - LEFT

Laminate doors are standard. **Includes three adjustable shelves.** Upper and lower locks secure both compartments

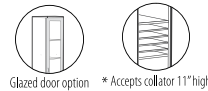
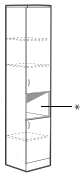

Storage Cabinet with Doors and Cavity - RIGHT

Z21L8SHCR	24 x 21 x 84-84.5	125	223.07	30.25	\$1419	\$1456	\$793	N/A
Z18L8SHCR	24 x 18 x 84-84.5	125	202.75	26.25	\$1336	\$1368	\$717	N/A
Z16L8SHCR	24 x 16 x 84-84.5	125	185.71	24	\$1253	\$1285	\$707	N/A
Z15L8SHCR	24 x 15 x 84-84.5	125	179.28	22.50	\$1241	\$1267	\$626	N/A
Z12L8SHCR	24 x 12 x 84-84.5	100	162.12	18.50	\$1113	\$1134	\$565	N/A
Z21M8SHCR	20 x 21 x 84-84.5	125	196.66	25.50	\$1278	\$1310	\$793	N/A
Z18M8SHCR	20 x 18 x 84-84.5	125	177.57	22.25	\$1230	\$1257	\$717	N/A
Z16M8SHCR	20 x 16 x 84-84.5	100	165.89	20.25	\$1155	\$1182	\$707	N/A
Z15M8SHCR	20 x 15 x 84-84.5	100	159.52	19	\$1107	\$1130	\$626	N/A
Z12M8SHCR	20 x 12 x 84-84.5	100	141.48	15.75	\$1028	\$1046	\$565	N/A
Z21S8SHCR	16 x 21 x 84-84.5	100	168.16	21	\$1174	\$1200	\$793	N/A
Z18S8SHCR	16 x 18 x 84-84.5	100	150.29	18	\$1101	\$1127	\$717	N/A
Z16S8SHCR	16 x 16 x 84-84.5	100	139.77	16.50	\$1034	\$1060	\$707	N/A
Z15S8SHCR	16 x 15 x 84-84.5	100	134.51	15.50	\$987	\$1008	\$626	N/A
Z12S8SHCR	16 x 12 x 84-84.5	100	117.69	13	\$912	\$930	\$565	N/A

Laminate doors are standard. **Includes three adjustable shelves.** Upper and lower locks secure both compartments

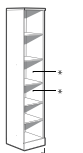
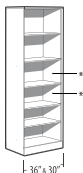

Open Storage Cabinet

Z36L8SHN	24 x 36 x 84-84.5	150	281.34	50	\$1495	\$1548	N/A	N/A
Z30L8SHN	24 x 30 x 84-84.5	150	247.23	42	\$1331	\$1377	N/A	N/A
Z21L8SHN	24 x 21 x 84-84.5	125	227.72	30.25	\$1151	\$1187	N/A	N/A
Z18L8SHN	24 x 18 x 84-84.5	125	206.74	26.25	\$1091	\$1123	N/A	N/A
Z16L8SHN	24 x 16 x 84-84.5	125	189.25	24	\$1012	\$1044	N/A	N/A
Z15L8SHN	24 x 15 x 84-84.5	100	182.61	22.50	\$996	\$1022	N/A	N/A
Z12L8SHN	24 x 12 x 84-84.5	100	164.78	18.50	\$956	\$979	N/A	N/A
Z36M8SHN	20 x 36 x 84-84.5	150	245.68	42.25	\$1344	\$1390	N/A	N/A
Z30M8SHN	20 x 30 x 84-84.5	125	215.06	35.50	\$1212	\$1251	N/A	N/A
Z21M8SHN	20 x 21 x 84-84.5	125	170.18	25.50	\$1017	\$1049	N/A	N/A
Z18M8SHN	20 x 18 x 84-84.5	125	154.86	22.25	\$984	\$1012	N/A	N/A
Z16M8SHN	20 x 16 x 84-84.5	125	145.71	20.25	\$913	\$940	N/A	N/A
Z15M8SHN	20 x 15 x 84-84.5	125	140.60	19	\$890	\$911	N/A	N/A
Z12M8SHN	20 x 12 x 84-84.5	100	126.34	15.75	\$829	\$847	N/A	N/A
Z36S8SHN	16 x 36 x 84-84.5	125	206.87	34	\$1168	\$1213	N/A	N/A
Z30S8SHN	16 x 30 x 84-84.5	125	180.79	29	\$1050	\$1081	N/A	N/A
Z21S8SHN	16 x 21 x 84-84.5	125	141.67	21	\$908	\$933	N/A	N/A
Z18S8SHN	16 x 18 x 84-84.5	125	127.58	18	\$814	\$840	N/A	N/A
Z16S8SHN	16 x 16 x 84-84.5	125	119.59	16.50	\$791	\$817	N/A	N/A
Z15S8SHN	16 x 15 x 84-84.5	125	115.59	15.50	\$770	\$790	N/A	N/A
Z12S8SHN	16 x 12 x 84-84.5	125	102.56	13	\$712	\$730	N/A	N/A

Five adjustable shelves.

Required Specifications

- Finishes
- Top/Edge Detail
- Handles

Optional Specifications

- Glazing - Doors
- Collator (Open Shelves)

STORAGE MODULES - 84" / 84.5" HIGH

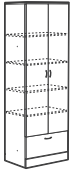

File Module with Doors

MODEL#	DIMENSIONS D x W x H	FREIGHT CLASS	WT/LBS.	CUBIC FT.	1" TOP	1.5" TOP	GLAZE ADD	HP ADD
Z36L8F	24 x 36 x 84-84.5	125	350.70	50	\$2210	\$2263	\$1184	N/A
Z30L8F	24 x 30 x 84-84.5	125	301.35	42	\$1976	\$2022	\$1003	N/A
Z36M8F	20 x 36 x 84-84.5	125	319.20	42.25	\$2069	\$2115	\$1184	N/A
Z30M8F	20 x 30 x 84-84.5	125	278.25	35.50	\$1865	\$1904	\$1003	N/A
Z36S8F	16 x 36 x 84-84.5	100	273	34	\$1853	\$1898	\$1184	N/A
Z30S8F	16 x 30 x 84-84.5	100	237.30	29	\$1664	\$1695	\$1003	N/A

One lateral file drawer. Laminate doors are standard. **Includes four adjustable shelves.** Upper lock secures storage shelves. Lower lock secures one file drawer. Front-to-back and side-to-side letter/legal filing capability. Side-to-side file bars included.

- Lateral file drawer construction is for accommodating hanging files NOT for stacking materials on the drawer bottom.



File Module with Door - LEFT

Z16L8FL	24 x 16 x 84-84.5	100	200.55	24	\$1353	\$1384	\$583	N/A
Z15L8FL	24 x 15 x 84-84.5	100	189	22.50	\$1318	\$1344	\$506	N/A
Z16M8FL	20 x 16 x 84-84.5	100	179.55	20.25	\$1253	\$1280	\$583	N/A
Z15M8FL	20 x 15 x 84-84.5	100	173.25	19	\$1210	\$1231	\$506	N/A
Z16S8FL	16 x 16 x 84-84.5	100	151.20	16.50	\$1129	\$1155	\$583	N/A
Z15S8FL	16 x 15 x 84-84.5	100	145.95	15.50	\$1092	\$1113	\$506	N/A

One file drawer. Laminate door is standard. **Includes four adjustable shelves.** Upper lock secures storage compartment. Lower lock secures one file drawer.

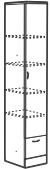

File Module with Door - RIGHT

Z16L8FR	24 x 16 x 84-84.5	100	200.55	24	\$1353	\$1384	\$583	N/A
Z15L8FR	24 x 15 x 84-84.5	100	189	22.50	\$1318	\$1344	\$506	N/A
Z16M8FR	20 x 16 x 84-84.5	100	179.55	20.25	\$1253	\$1280	\$583	N/A
Z15M8FR	20 x 15 x 84-84.5	100	173.25	19	\$1210	\$1231	\$506	N/A
Z16S8FR	16 x 16 x 84-84.5	100	151.20	16.50	\$1129	\$1155	\$583	N/A
Z15S8FR	16 x 15 x 84-84.5	100	145.95	15.50	\$1092	\$1113	\$506	N/A

One file drawer. Laminate door is standard. **Includes four adjustable shelves.** Upper lock secures storage compartment. Lower lock secures one file drawer.

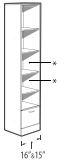
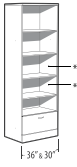

File Module with Open Shelves

Z36L8FN	24 x 36 x 84-84.5	125	307.17	50	\$1808	\$1861	N/A	N/A
Z30L8FN	24 x 30 x 84-84.5	125	264.38	42	\$1626	\$1672	N/A	N/A
Z16L8FN	24 x 16 x 84-84.5	125	182.72	24	\$1158	\$1190	N/A	N/A
Z15L8FN	24 x 15 x 84-84.5	125	171.04	22.50	\$1140	\$1166	N/A	N/A
Z36M8FN	20 x 36 x 84-84.5	125	273.61	42.25	\$1666	\$1713	N/A	N/A
Z30M8FN	20 x 30 x 84-84.5	125	240.61	35.50	\$1514	\$1553	N/A	N/A
Z16M8FN	20 x 16 x 84-84.5	125	159.75	20.25	\$1059	\$1086	N/A	N/A
Z15M8FN	20 x 15 x 84-84.5	100	154.43	19	\$1031	\$1054	N/A	N/A
Z36S8FN	16 x 36 x 84-84.5	125	228.50	34	\$1386	\$1431	N/A	N/A
Z30S8FN	16 x 30 x 84-84.5	125	200.04	29	\$1248	\$1279	N/A	N/A
Z16S8FN	16 x 16 x 84-84.5	125	131.54	16.50	\$934	\$960	N/A	N/A
Z15S8FN	16 x 15 x 84-84.5	100	127.32	15.50	\$914	\$935	N/A	N/A

Five open shelves and one file drawer on bottom. **Includes four adjustable shelves.** Lock secures file drawer. 36" and 30" wide models have front-to-back and side-to-side letter/legal filing capability. Side-to-side file bars included.

- Lateral file drawer construction is for accommodating hanging files NOT for stacking materials on the drawer bottom.

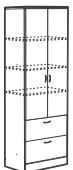

Two File Module with Doors

Z36L8E	24 x 36 x 84-84.5	125	365.40	50	\$2388	\$2441	\$1022	N/A
Z30L8E	24 x 30 x 84-84.5	125	306.60	42	\$2174	\$2219	\$881	N/A
Z36M8E	20 x 36 x 84-84.5	125	323.40	42.25	\$2244	\$2290	\$1022	N/A
Z30M8E	20 x 30 x 84-84.5	100	284.55	35.50	\$2067	\$2106	\$881	N/A
Z36S8E	16 x 36 x 84-84.5	100	285	34	\$2049	\$2095	\$1022	N/A
Z30S8E	16 x 30 x 84-84.5	100	244.65	29	\$1852	\$1883	\$881	N/A

Two lateral file drawers. Laminate doors are standard. **Includes three adjustable shelves.** Upper lock secures storage compartment. Lower lock secures two file drawers. Front-to-back and side-to-side letter/legal filing capability. Side-to-side file bars included.

- Lateral file drawer construction is for accommodating hanging files NOT for stacking materials on the drawer bottom.

Required Specifications

Finishes
Top/Edge Detail
Handles

Optional Specifications

Glazing - Doors
Collator (Open Shelves)
Box Drawer Option (no upcharge)

STORAGE MODULES - 84" / 84.5" HIGH



Glazed door option

Two File Module with Door - LEFT

MODEL#	DIMENSIONS D x W x H	FREIGHT CLASS	WT/LBS.	CUBIC FT.	1" TOP	1.5" TOP	GLAZE ADD	HP ADD
Z16L8EL	24 x 16 x 84-84.5	100	205.80	24	\$1421	\$1453	\$502	N/A
Z15L8EL	24 x 15 x 84-84.5	100	192.15	22.50	\$1381	\$1407	\$437	N/A
Z16M8EL	20 x 16 x 84-84.5	100	185.85	20.25	\$1331	\$1358	\$502	N/A
Z15M8EL	20 x 15 x 84-84.5	100	179.55	19	\$1280	\$1303	\$437	N/A
Z16S8EL	16 x 16 x 84-84.5	100	156.45	16.50	\$1209	\$1235	\$502	N/A
Z15S8EL	16 x 15 x 84-84.5	100	149.10	15.50	\$1169	\$1189	\$437	N/A

Two file drawers on bottom. Laminate door is standard. **Includes three 3-position fixed/height adjustable shelves.** Upper lock secures storage compartment. Lower lock secures two file drawers.



Glazed door option

Two File Module with Door - RIGHT

Z16L8ER	24 x 16 x 84-84.5	100	205.80	24	\$1421	\$1453	\$502	N/A
Z15L8ER	24 x 15 x 84-84.5	100	192.15	22.50	\$1381	\$1407	\$437	N/A
Z16M8ER	20 x 16 x 84-84.5	100	185.85	20.25	\$1331	\$1358	\$502	N/A
Z15M8ER	20 x 15 x 84-84.5	100	179.55	19	\$1280	\$1303	\$437	N/A
Z16S8ER	16 x 16 x 84-84.5	100	156.45	16.50	\$1209	\$1235	\$502	N/A
Z15S8ER	16 x 15 x 84-84.5	100	149.10	15.50	\$1169	\$1189	\$437	N/A

Two file drawers on bottom. Laminate door is standard. **Includes three 3-position fixed/height adjustable shelves.** Upper lock secures storage compartment. Lower lock secures two file drawers.

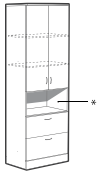

Glazed door option * Accepts collator 11" high

Two File Module with Doors and Cavity

Z36L8EC	24 x 36 x 84-84.5	125	359.30	50	\$2326	\$2380	\$890	N/A
Z30L8EC	24 x 30 x 84-84.5	125	300.82	42	\$2123	\$2169	\$774	N/A
Z36M8EC	20 x 36 x 84-84.5	125	315.24	42.25	\$2182	\$2228	\$890	N/A
Z30M8EC	20 x 30 x 84-84.5	125	278.10	35.50	\$2016	\$2055	\$774	N/A
Z36S8EC	16 x 36 x 84-84.5	100	276	34	\$1862	\$1907	\$890	N/A
Z30S8EC	16 x 30 x 84-84.5	100	236.48	29	\$1675	\$1706	\$774	N/A

Two lateral file drawers on bottom. Laminate doors are standard. **Includes two 3-position fixed/height adjustable shelves.** Upper lock secures storage compartment. Lower lock secures all drawers. Front-to-back and side-to-side letter/legal filing capability. Side-to-side file bars included.

- Lateral file drawer construction is for accommodating hanging files NOT for stacking materials on the drawer bottom.

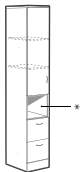

Glazed door option * Accepts collator 11" high

Two File Module with Doors and Cavity - LEFT

Z16L8ECL	24 x 16 x 84-84.5	100	204.61	24	\$1339	\$1371	\$436	N/A
Z15L8ECL	24 x 15 x 84-84.5	100	189.78	22.50	\$1355	\$1381	\$384	N/A
Z16M8ECL	20 x 16 x 84-84.5	100	182.69	20.25	\$1290	\$1317	\$436	N/A
Z15M8ECL	20 x 15 x 84-84.5	100	176.32	19	\$1245	\$1266	\$384	N/A
Z16S8ECL	16 x 16 x 84-84.5	100	152.37	16.50	\$1178	\$1204	\$436	N/A
Z15S8ECL	16 x 15 x 84-84.5	100	146.06	15.50	\$1142	\$1163	\$384	N/A

Two lateral file drawers on bottom. Laminate doors are standard. **Includes two 3-position fixed/height adjustable shelves.** Upper lock secures storage compartment. Lower lock secures all drawers.

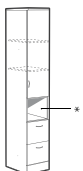

Glazed door option * Accepts collator 11" high

Two File Module with Doors and Cavity - LEFT

Z16L8ECR	24 x 16 x 84-84.5	100	204.61	24	\$1339	\$1371	\$436	N/A
Z15L8ECR	24 x 15 x 84-84.5	100	189.78	22.50	\$1355	\$1381	\$384	N/A
Z16M8ECR	20 x 16 x 84-84.5	100	182.69	20.25	\$1290	\$1317	\$436	N/A
Z15M8ECR	20 x 15 x 84-84.5	100	176.32	19	\$1245	\$1266	\$384	N/A
Z16S8ECR	16 x 16 x 84-84.5	100	152.37	16.50	\$1178	\$1204	\$436	N/A
Z15S8ECR	16 x 15 x 84-84.5	100	146.06	15.50	\$1142	\$1163	\$384	N/A

Two lateral file drawers on bottom. Laminate doors are standard. **Includes two 3-position fixed/height adjustable shelves.** Upper lock secures storage compartment. Lower lock secures all drawers.

Required Specifications

Finishes
Top/Edge Detail
Handles

Optional Specifications

Glazing - Doors
Collator (Open Shelves)
Box Drawer Option (no upcharge)

STORAGE MODULES - 84" / 84.5" HIGH

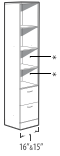
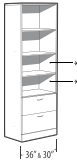

Two File Module with Open Shelves

MODEL#	DIMENSIONS D x W x H	FREIGHT CLASS	WT./LBS.	CUBIC FT.	1" TOP	1.5" TOP	GLAZE ADD	HP ADD
Z36L8EN	24 x 36 x 84-84.5	125	329.85	50	\$2046	\$2099	N/A	N/A
Z30L8EN	24 x 30 x 84-84.5	125	276.28	42	\$1874	\$1920	N/A	N/A
Z16L8EN	24 x 16 x 84-84.5	125	191.52	24	\$1248	\$1280	N/A	N/A
Z15L8EN	24 x 15 x 84-84.5	125	177.51	22.50	\$1230	\$1256	N/A	N/A
Z36M8EN	20 x 36 x 84-84.5	125	285.79	42.25	\$1902	\$1948	N/A	N/A
Z30M8EN	20 x 30 x 84-84.5	125	253.56	35.50	\$1769	\$1808	N/A	N/A
Z16M8EN	20 x 16 x 84-84.5	100	169.60	20.25	\$1159	\$1186	N/A	N/A
Z15M8EN	20 x 15 x 84-84.5	100	164.05	19	\$1128	\$1151	N/A	N/A
Z36S8EN	16 x 36 x 84-84.5	125	247	34	\$1581	\$1626	N/A	N/A
Z30S8EN	16 x 30 x 84-84.5	125	213	29	\$1426	\$1457	N/A	N/A
Z16S8EN	16 x 16 x 84-84.5	100	139.28	16.50	\$1036	\$1062	N/A	N/A
Z15S8EN	16 x 15 x 84-84.5	100	133.79	15.50	\$1017	\$1037	N/A	N/A

Four open shelves and two file drawers on bottom. **Includes two 3-position fixed/height adjustable shelves.** Lock secures all drawers. 36" and 30" wide models have front-to-back and side-to-side letter/legal filing capability. Side-to-side file bars included.

- Lateral file drawer construction is for accommodating hanging files NOT for stacking materials on the drawer bottom.



Three File Module with Doors

Z36L83F	24 x 36 x 84-84.5	125	357	50	\$2575	\$2628	\$890	N/A
Z30L83F	24 x 30 x 84-84.5	125	319.20	42	\$2358	\$2404	\$774	N/A
Z36M83F	20 x 36 x 84-84.5	125	328.65	42.25	\$2445	\$2491	\$890	N/A
Z30M83F	20 x 30 x 84-84.5	100	291.90	35.50	\$2261	\$2300	\$774	N/A
Z36S83F	16 x 36 x 84-84.5	100	289	34	\$2226	\$2271	\$890	N/A
Z30S83F	16 x 30 x 84-84.5	100	246.75	29	\$2022	\$2053	\$774	N/A

Three lateral file drawers on bottom. Laminate doors are standard. **Includes two 3-position fixed/height adjustable shelves.** Upper lock secures storage compartment. Lower lock secures three file drawers. Front-to-back and side-to-side letter/legal filing capability. Side-to-side file bars included.

- Lateral file drawer construction is for accommodating hanging files NOT for stacking materials on the drawer bottom.

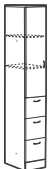

Three File Module with Door - LEFT

Z16L83FL	24 x 16 x 84-84.5	100	215.25	24	\$1521	\$1553	\$436	N/A
Z15L83FL	24 x 15 x 84-84.5	100	206.85	22.50	\$1468	\$1494	\$384	N/A
Z16M83FL	20 x 16 x 84-84.5	100	192.15	20.25	\$1432	\$1459	\$436	N/A
Z15M83FL	20 x 15 x 84-84.5	100	184.80	19	\$1386	\$1407	\$384	N/A
Z16S83FL	16 x 16 x 84-84.5	100	161.70	16.50	\$1305	\$1331	\$436	N/A
Z15S83FL	16 x 15 x 84-84.5	92.5	155.40	15.50	\$1271	\$1291	\$384	N/A

Three file drawers on bottom. Laminate door is standard. **Includes two 3-position fixed/height adjustable shelves.** Upper lock secures storage compartment. Lower lock secures three file drawers.

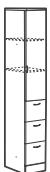

Three File Module with Door - RIGHT

Z16L83FR	24 x 16 x 84-84.5	100	215.25	24	\$1521	\$1553	\$436	N/A
Z15L83FR	24 x 15 x 84-84.5	100	206.85	22.50	\$1468	\$1494	\$384	N/A
Z16M83FR	20 x 16 x 84-84.5	100	192.15	20.25	\$1432	\$1459	\$436	N/A
Z15M83FR	20 x 15 x 84-84.5	100	184.80	19	\$1386	\$1407	\$384	N/A
Z16S83FR	16 x 16 x 84-84.5	100	161.70	16.50	\$1305	\$1331	\$436	N/A
Z15S83FR	16 x 15 x 84-84.5	92.5	155.40	15.50	\$1271	\$1291	\$384	N/A

Three file drawers on bottom. Laminate door is standard. **Includes two 3-position fixed/height adjustable shelves.** Upper lock secures storage compartment. Lower lock secures three file drawers.

Required Specifications

Finishes
Top/Edge Detail
Handles

Optional Specifications

Glazing - Doors
Collator (Open Shelves)
Box Drawer Option (no upcharge)

STORAGE MODULES - 84" / 84.5" HIGH

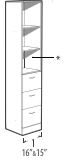
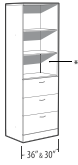

* Accepts collator 11" high

Three File Module with Open Shelves

MODEL#	DIMENSIONS D x W x H	FREIGHT CLASS	WT/LBS.	CUBIC FT.	1" TOP	1.5" TOP	GLAZE ADD	HP ADD
Z36L83FN	24 x 36 x 84-84.5	125	329.44	50	\$2294	\$2348	N/A	N/A
Z30L83FN	24 x 30 x 84-84.5	125	295.53	42	\$2109	\$2155	N/A	N/A
Z16L83FN	24 x 16 x 84-84.5	100	204.52	24	\$1379	\$1410	N/A	N/A
Z15L83FN	24 x 15 x 84-84.5	100	195.54	22.50	\$1342	\$1368	N/A	N/A
Z36M83FN	20 x 36 x 84-84.5	125	299.02	42.25	\$2163	\$2209	N/A	N/A
Z30M83FN	20 x 30 x 84-84.5	125	267.56	35.50	\$2012	\$2051	N/A	N/A
Z16M83FN	20 x 16 x 84-84.5	100	179.45	20.25	\$1289	\$1317	N/A	N/A
Z15M83FN	20 x 15 x 84-84.5	100	172.63	19	\$1259	\$1282	N/A	N/A
Z36S83FN	16 x 36 x 84-84.5	125	260	34	\$1755	\$1800	N/A	N/A
Z30S83FN	16 x 30 x 84-84.5	125	222.79	29	\$1582	\$1614	N/A	N/A
Z16S83FN	16 x 16 x 84-84.5	100	149.13	16.50	\$1162	\$1188	N/A	N/A
Z15S83FN	16 x 15 x 84-84.5	100	143.42	15.50	\$1145	\$1165	N/A	N/A

Three open shelves and three file drawers on bottom. **Includes two 3-position fixed/height adjustable shelves.** Lock secures all drawers. 36" and 30" wide models have front-to-back and side-to-side letter/legal filing capability. Side-to-side file bars included.

- Lateral file drawer construction is for accommodating hanging files NOT for stacking materials on the drawer bottom.

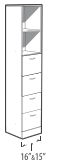
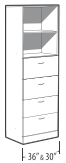

Four File Module with Open Shelf

Z36L84FN	24 x 36 x 84-84.5	125	340.57	50	\$2519	\$2573	N/A	N/A
Z30L84FN	24 x 30 x 84-84.5	125	308.48	42	\$2336	\$2382	N/A	N/A
Z16L84FN	24 x 16 x 84-84.5	100	208.06	24	\$1457	\$1488	N/A	N/A
Z15L84FN	24 x 15 x 84-84.5	100	200.97	22.50	\$1430	\$1456	N/A	N/A
Z36M84FN	20 x 36 x 84-84.5	125	313.30	42.25	\$2401	\$2447	N/A	N/A
Z30M84FN	20 x 30 x 84-84.5	125	282.61	35.50	\$2245	\$2283	N/A	N/A
Z16M84FN	20 x 16 x 84-84.5	100	187.20	20.25	\$1356	\$1383	N/A	N/A
Z15M84FN	20 x 15 x 84-84.5	100	181.21	19	\$1351	\$1374	N/A	N/A
Z36S84FN	16 x 36 x 84-84.5	125	265.04	34	\$1895	\$1940	N/A	N/A
Z30S84FN	16 x 30 x 84-84.5	100	233.64	29	\$1707	\$1738	N/A	N/A
Z16S84FN	16 x 16 x 84-84.5	100	156.88	16.50	\$1259	\$1285	N/A	N/A
Z15S84FN	16 x 15 x 84-84.5	100	152	15.50	\$1244	\$1265	N/A	N/A

Two open shelves and four file drawers. **Includes one 3-position fixed/height adjustable shelf.** Lock secures all drawers. 36" and 30" wide models have front-to-back and side-to-side letter/legal filing capability. Side-to-side file bars included.

- Lateral file drawer construction is for accommodating hanging files NOT for stacking materials on the drawer bottom.

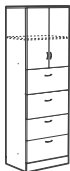

Glazed door option

Four File Module with Doors

Z36L84F	24 x 36 x 84-84.5	125	360.15	50	\$2758	\$2811	\$700	N/A
Z30L84F	24 x 30 x 84-84.5	125	325.50	42	\$2549	\$2595	\$609	N/A
Z36M84F	20 x 36 x 84-84.5	125	334.95	42.25	\$2638	\$2685	\$700	N/A
Z30M84F	20 x 30 x 84-84.5	100	300.30	35.50	\$2459	\$2498	\$609	N/A
Z36S84F	16 x 36 x 84-84.5	100	285.60	34	\$2386	\$2431	\$700	N/A
Z30S84F	16 x 30 x 84-84.5	100	250.95	29	\$2174	\$2205	\$609	N/A

Four lateral file drawers on bottom. Laminate doors are standard. **Includes one 3-position fixed/height adjustable shelf.** Upper lock secures storage compartment. Lower lock secures four file drawers. Front-to-back and side-to-side letter/legal filing capability. Side-to-side file bars included.

- Lateral file drawer construction is for accommodating hanging files NOT for stacking materials on the drawer bottom.

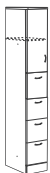

Glazed door option

Four File Module with Door - LEFT

Z16L84FL	24 x 16 x 84-84.5	100	217.35	24	\$1577	\$1609	\$342	N/A
Z15L84FL	24 x 15 x 84-84.5	100	208.95	22.50	\$1538	\$1564	\$344	N/A
Z16M84FL	20 x 16 x 84-84.5	100	196.35	20.25	\$1477	\$1504	\$342	N/A
Z15M84FL	20 x 15 x 84-84.5	92.5	190.05	19	\$1459	\$1482	\$301	N/A
Z16S84FL	16 x 16 x 84-84.5	92.5	166.95	16.50	\$1380	\$1406	\$342	N/A
Z15S84FL	16 x 15 x 84-84.5	92.5	160.65	15.50	\$1352	\$1373	\$301	N/A

Four file drawers on bottom. Laminate door is standard. **Includes one 3-position fixed/height adjustable shelf.** Upper lock secures storage compartment. Lower lock secures four file drawers.

Required Specifications

Finishes
Top/Edge Detail
Handles

Optional Specifications

Glazing - Doors
Collator (Open Shelves)
Box Drawer Option (no upcharge)

STORAGE MODULES - 84" / 84.5" HIGH



Glazed door option

Four File Module with Door - RIGHT

MODEL#	DIMENSIONS D x W x H	FREIGHT CLASS	WT./LBS.	CUBIC FT.	1" TOP	1.5" TOP	GLAZE ADD	HP ADD
Z16L84FR	24 x 16 x 84-84.5	100	217.35	24	\$1577	\$1609	\$342	N/A
Z15L84FR	24 x 15 x 84-84.5	100	208.95	22.50	\$1538	\$1564	\$344	N/A
Z16M84FR	20 x 16 x 84-84.5	100	196.35	20.25	\$1477	\$1504	\$342	N/A
Z15M84FR	20 x 15 x 84-84.5	92.5	190.05	19	\$1459	\$1482	\$301	N/A
Z16S84FR	16 x 16 x 84-84.5	92.5	166.95	16.50	\$1380	\$1406	\$342	N/A
Z15S84FR	16 x 15 x 84-84.5	92.5	160.65	15.50	\$1352	\$1373	\$301	N/A

Four file drawers on bottom. Laminate door is standard. **Includes one 3-position fixed/height adjustable shelf.** Upper lock secures storage compartment. Lower lock secures four file drawers.

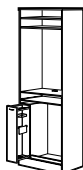

Intended for working while standing

Media Center - LEFT

Z36L8MCL	24 x 36 x 84-84.5	125	324.45	50	\$2082	\$2136	N/A	N/A
Z30L8MCL	24 x 30 x 84-84.5	125	290.85	42	\$1934	\$1980	N/A	N/A
Z36M8MCL	20 x 36 x 84-84.5	125	276.15	42.25	\$1929	\$1975	N/A	N/A
Z30M8MCL	20 x 30 x 84-84.5	125	257.25	35.50	\$1772	\$1811	N/A	N/A
Z36S8MCL	16 x 36 x 84-84.5	125	246.75	34	\$1711	\$1756	N/A	N/A
Z30S8MCL	16 x 30 x 84-84.5	125	212.10	29	\$1558	\$1589	N/A	N/A

Unit, accommodates pc, keyboard, monitor, hanging folders and accessories and/or printer. One vertical drawer on the **left**. Pull out keyboard shelf. Adjustable pull out bottom shelf accommodates pc and/or printer. **Includes two 3-position fixed/height adjustable shelves.** Grommet in worksurface and back panel. Lock secures vertical drawer.

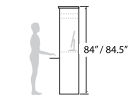

Intended for working while standing

Media Center - LEFT

Z36L8MCR	24 x 36 x 84-84.5	125	324.45	50	\$2082	\$2136	N/A	N/A
Z30L8MCR	24 x 30 x 84-84.5	125	290.85	42	\$1934	\$1980	N/A	N/A
Z36M8MCR	20 x 36 x 84-84.5	125	276.15	42.25	\$1929	\$1975	N/A	N/A
Z30M8MCR	20 x 30 x 84-84.5	125	257.25	35.50	\$1772	\$1811	N/A	N/A
Z36S8MCR	16 x 36 x 84-84.5	125	246.75	34	\$1711	\$1756	N/A	N/A
Z30S8MCR	16 x 30 x 84-84.5	125	212.10	29	\$1558	\$1589	N/A	N/A

Unit, accommodates pc, keyboard, monitor, hanging folders and accessories and/or printer. One vertical drawer on the **right**. Pull out keyboard shelf. Adjustable pull out bottom shelf accommodates pc and/or printer. **Includes two 3-position fixed/height adjustable shelves.** Grommet in worksurface and back panel. Lock secures vertical drawer.

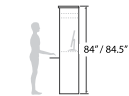

Intended for working while standing

PC Center

Z36L8PC	24 x 36 x 84-84.5	150	285.60	50	\$1604	\$1658	N/A	135
Z30L8PC	24 x 30 x 84-84.5	125	252	42	\$1424	\$1470	N/A	113
Z36M8PC	20 x 36 x 84-84.5	150	250.95	42.25	\$1475	\$1522	N/A	135
Z30M8PC	20 x 30 x 84-84.5	125	219.45	35.50	\$1325	\$1364	N/A	113
Z36S8PC	16 x 36 x 84-84.5	125	218.40	34	\$1277	\$1322	N/A	101
Z30S8PC	16 x 30 x 84-84.5	125	183.75	29	\$1130	\$1161	N/A	91

Standing height unit, accommodates pc, keyboard, monitor and/or printer. Pull out keyboard shelf. Adjustable pull out bottom shelf accommodates pc and/or printer. **Includes two 3-position fixed/height adjustable shelves.** Grommet in worksurface and back panel.

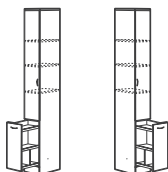

Glazed door option

LEFT RIGHT
Vertical Utility Drawer with Door

Z12L8VDL	24 x 12 x 84-84.5	100	184.80	18.50	\$1405	\$1426	\$391	N/A
Z12M8VDL	20 x 12 x 84-84.5	92.5	166.95	15.75	\$1145	\$1164	\$391	N/A
Z12S8VDL	16 x 12 x 84-84.5	92.5	139.65	13	\$1053	\$1071	\$391	N/A
Z12L8VDR	24 x 12 x 84-84.5	100	184.80	18.50	\$1405	\$1426	\$391	N/A
Z12M8VDR	20 x 12 x 84-84.5	92.5	166.95	15.75	\$1145	\$1164	\$391	N/A
Z12S8VDR	16 x 12 x 84-84.5	92.5	139.65	13	\$1053	\$1071	\$391	N/A

Specify **VDL** models for **LEFT** or **VDR** models for **RIGHT**

Laminate doors are standard. **Includes three 3-position fixed/height adjustable shelves** and one vertical drawer. Upper lock secures storage compartment. Lower lock secures vertical drawer.

Required Specifications

Finishes
Top/Edge Detail
Handles

Optional Specifications

Glazing - Doors
Collator (Open Shelves)
Box Drawer Option (no upcharge - Four File Module)

WARDROBE CABINETS - 84" / 84.5" HIGH



Wardrobe Cabinet

MODEL#	DIMENSIONS	FREIGHT CLASS	WT/LBS.	CUBIC FT.	1" TOP	1.5" TOP	GLAZE ADD	HP ADD
Z36L8WA	24 x 36 x 84-84.5	150	290.85	50	\$1785	\$1838	N/A	N/A
Z30L8WA	24 x 30 x 84-84.5	125	256.20	42	\$1602	\$1648	N/A	N/A
Z36M8WA	20 x 36 x 84-84.5	125	264.60	42.25	\$1667	\$1713	N/A	N/A
Z30M8WA	20 x 30 x 84-84.5	125	231	35.50	\$1507	\$1546	N/A	N/A

Laminate doors are standard. Full length hanging rod included. **One adjustable shelf** above hanging rod. Standard with lock.



Wardrobe Cabinet - LEFT

MODEL#	DIMENSIONS	FREIGHT CLASS	WT/LBS.	CUBIC FT.	1" TOP	1.5" TOP	GLAZE ADD	HP ADD
Z24L8WAL	24 x 24 x 84-84.5	125	220.50	34.25	\$1337	\$1374	N/A	N/A
Z21L8WAL	24 x 21 x 84-84.5	125	192.15	30.25	\$1288	\$1324	N/A	N/A
Z18L8WAL	24 x 18 x 84-84.5	125	184.80	26.25	\$1200	\$1232	N/A	N/A
Z16L8WAL	24 x 16 x 84-84.5	125	172.20	24	\$1145	\$1176	N/A	N/A
Z15L8WAL	24 x 15 x 84-84.5	125	161.70	22.50	\$1112	\$1138	N/A	N/A
Z12L8WAL	24 x 12 x 84-84.5	100	150.15	18.50	\$1023	\$1046	N/A	N/A
Z24M8WAL	20 x 24 x 84-84.5	125	197.40	28.50	\$1245	\$1277	N/A	N/A
Z21M8WAL	20 x 21 x 84-84.5	125	182.70	25.50	\$1199	\$1231	N/A	N/A
Z18M8WAL	20 x 18 x 84-84.5	125	164.85	22.25	\$1111	\$1138	N/A	N/A
Z16M8WAL	20 x 16 x 84-84.5	125	154.35	20.25	\$1060	\$1087	N/A	N/A
Z15M8WAL	20 x 15 x 84-84.5	125	149.10	19	\$1016	\$1039	N/A	N/A
Z12M8WAL	20 x 12 x 84-84.5	100	133.35	15.75	\$948	\$966	N/A	N/A

Laminate doors are standard. Full length hanging rod included. **One adjustable shelf** above hanging rod. Standard with lock.



Wardrobe Cabinet - RIGHT

MODEL#	DIMENSIONS	FREIGHT CLASS	WT/LBS.	CUBIC FT.	1" TOP	1.5" TOP	GLAZE ADD	HP ADD
Z24L8WAR	24 x 24 x 84-84.5	125	220.50	34.25	\$1337	\$1374	N/A	N/A
Z21L8WAR	24 x 21 x 84-84.5	125	192.15	30.25	\$1288	\$1324	N/A	N/A
Z18L8WAR	24 x 18 x 84-84.5	125	184.80	26.25	\$1200	\$1232	N/A	N/A
Z16L8WAR	24 x 16 x 84-84.5	125	172.20	24	\$1145	\$1176	N/A	N/A
Z15L8WAR	24 x 15 x 84-84.5	125	161.70	22.50	\$1112	\$1138	N/A	N/A
Z12L8WAR	24 x 12 x 84-84.5	100	150.15	18.50	\$1023	\$1046	N/A	N/A
Z24M8WAR	20 x 24 x 84-84.5	125	197.40	28.50	\$1245	\$1277	N/A	N/A
Z21M8WAR	20 x 21 x 84-84.5	125	182.70	25.50	\$1199	\$1231	N/A	N/A
Z18M8WAR	20 x 18 x 84-84.5	125	164.85	22.25	\$1111	\$1138	N/A	N/A
Z16M8WAR	20 x 16 x 84-84.5	125	154.35	20.25	\$1060	\$1087	N/A	N/A
Z15M8WAR	20 x 15 x 84-84.5	125	149.10	19	\$1016	\$1039	N/A	N/A
Z12M8WAR	20 x 12 x 84-84.5	100	133.35	15.75	\$948	\$966	N/A	N/A

Laminate doors are standard. Full length hanging rod included. **One adjustable shelf** above hanging rod. Standard with lock.



Glazed door option

Wardrobe Cabinet/Shelving Combo with Doors - LEFT

MODEL#	DIMENSIONS	FREIGHT CLASS	WT/LBS.	CUBIC FT.	1" TOP	1.5" TOP	GLAZE ADD	HP ADD
Z36L8DIL	24 x 36 x 84-84.5	125	339	50	\$2065	\$2118	\$1369	N/A
Z30L8DIL	24 x 30 x 84-84.5	125	301	42	\$1812	\$1858	\$1171	N/A
Z24L8DIL	24 x 24 x 84-84.5	125	269	34.25	\$1638	\$1675	\$1074	N/A
Z21L8DIL	24 x 21 x 84-84.5	100	252	30.25	\$1586	\$1607	\$1066	N/A
Z36M8DIL	20 x 36 x 84-84.5	125	306	42.25	\$1942	\$1988	\$1369	N/A
Z30M8DIL	20 x 30 x 84-84.5	125	266	35.50	\$1713	\$1752	\$1171	N/A
Z24M8DIL	20 x 24 x 84-84.5	100	233	28.50	\$1544	\$1577	\$1074	N/A
Z21M8DIL	20 x 21 x 84-84.5	100	215	25.50	\$1467	\$1505	\$1066	N/A

Laminate doors are standard. Storage compartment on **left includes five adjustable shelves**. Wardrobe compartment on **right** includes hanging rod and **one adjustable shelf** above rod. Single lock secures storage and wardrobe compartments.



Glazed door option

Wardrobe Cabinet/Shelving Combo with Doors - RIGHT

MODEL#	DIMENSIONS	FREIGHT CLASS	WT/LBS.	CUBIC FT.	1" TOP	1.5" TOP	GLAZE ADD	HP ADD
Z36L8DIR	24 x 36 x 84-84.5	125	339	50	\$2065	\$2118	\$1369	N/A
Z30L8DIR	24 x 30 x 84-84.5	125	301	42	\$1812	\$1858	\$1171	N/A
Z24L8DIR	24 x 24 x 84-84.5	125	269	34.25	\$1638	\$1675	\$1074	N/A
Z21L8DIR	24 x 21 x 84-84.5	100	252	30.25	\$1586	\$1607	\$1066	N/A
Z36M8DIR	20 x 36 x 84-84.5	125	306	42.25	\$1942	\$1988	\$1369	N/A
Z30M8DIR	20 x 30 x 84-84.5	125	266	35.50	\$1713	\$1752	\$1171	N/A
Z24M8DIR	20 x 24 x 84-84.5	100	233	28.50	\$1544	\$1577	\$1074	N/A
Z21M8DIR	20 x 21 x 84-84.5	100	215	25.50	\$1467	\$1505	\$1066	N/A

Laminate doors are standard. Storage compartment on **right includes five adjustable shelves**. Wardrobe compartment on **left** includes hanging rod and **one adjustable shelf** above rod. Single lock secures storage and wardrobe compartments.

Required Specifications

Finishes
Top/Edge Detail
Handles

Optional Specifications

Glazing - Doors (Combo Units)

WARDROBE CABINETS - 84" / 84.5" HIGH

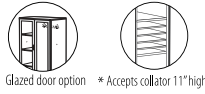
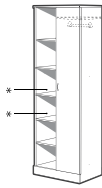

Wardrobe Cabinet/Open Shelving Combo - LEFT

MODEL#	DIMENSIONS D x W x H	FREIGHT CLASS	WT./LBS.	CUBIC FT.	1" TOP	1.5" TOP	GLAZE ADD	HP ADD
Z36L8DINL	24 x 36 x 84-84.5	125	312	50	\$1848	\$1901	\$681	N/A
Z30L8DINL	24 x 30 x 84-84.5	125	278	42	\$1622	\$1668	\$582	N/A
Z24L8DINL	24 x 24 x 84-84.5	125	245	34.25	\$1484	\$1521	\$519	N/A
Z21L8DINL	24 x 21 x 84-84.5	125	236	30.25	\$1446	\$1462	\$516	N/A
Z36M8DINL	20 x 36 x 84-84.5	125	275	42.25	\$1726	\$1772	\$681	N/A
Z30M8DINL	20 x 30 x 84-84.5	125	243	35.50	\$1525	\$1564	\$582	N/A
Z24M8DINL	20 x 24 x 84-84.5	125	215	28.50	\$1390	\$1422	\$519	N/A
Z21M8DINL	20 x 21 x 84-84.5	125	199	25.50	\$1328	\$1360	\$516	N/A

Laminate door is standard on wardrobe section. Storage compartment on **left includes five adjustable shelves**. Wardrobe compartment on **right** includes hanging rod and **one adjustable shelf** above rod. Single lock secures storage and wardrobe compartments.

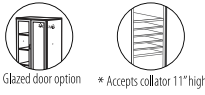
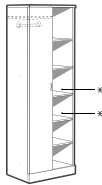

Wardrobe Cabinet/Open Shelving Combo - RIGHT

Z36L8DINR	24 x 36 x 84-84.5	125	312	50	\$1848	\$1901	\$681	N/A
Z30L8DINR	24 x 30 x 84-84.5	125	278	42	\$1622	\$1668	\$582	N/A
Z24L8DINR	24 x 24 x 84-84.5	125	245	34.25	\$1484	\$1521	\$519	N/A
Z21L8DINR	24 x 21 x 84-84.5	125	236	30.25	\$1446	\$1462	\$516	N/A
Z36M8DINR	20 x 36 x 84-84.5	125	275	42.25	\$1726	\$1772	\$681	N/A
Z30M8DINR	20 x 30 x 84-84.5	125	243	35.50	\$1525	\$1564	\$582	N/A
Z24M8DINR	20 x 24 x 84-84.5	125	215	28.50	\$1390	\$1422	\$519	N/A
Z21M8DINR	20 x 21 x 84-84.5	125	199	25.50	\$1328	\$1360	\$516	N/A

Laminate door is standard on wardrobe section. Storage compartment on **right includes five adjustable shelves**. Wardrobe compartment on **left** includes hanging rod and **one adjustable shelf** above rod. Single lock secures storage and wardrobe compartments.

PERSONAL TOWERS - 84" / 84.5" HIGH

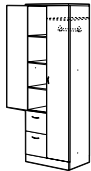

Personal Tower with Doors - LEFT

Z36L8EL	24 x 36 x 84-84.5	125	368.55	50	\$2205	\$2259	\$1187	N/A
Z30L8EL	24 x 30 x 84-84.5	125	334.95	42	\$2013	\$2059	\$1082	N/A
Z24L8EL	24 x 24 x 84-84.5	100	299.24	34.25	\$1946	\$1984	\$934	N/A
Z36M8EL	20 x 36 x 84-84.5	125	332.85	42.25	\$2084	\$2130	\$1187	N/A
Z30M8EL	20 x 30 x 84-84.5	100	298.20	35.50	\$1921	\$1960	\$1082	N/A
Z24M8EL	20 x 24 x 84-84.5	100	266	29	\$1833	\$1865	\$934	N/A

Two file drawers on bottom. Laminate doors are standard. Storage compartment on **left includes three adjustable shelves**. Wardrobe compartment on **right** includes hanging rod and **one adjustable shelf** above rod. Two upper locks secure storage and wardrobe compartments. Lower lock secures all drawers.

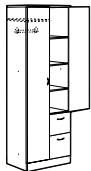

Personal Tower with Doors - RIGHT

Z36L8ER	24 x 36 x 84-84.5	125	368.55	50	\$2205	\$2259	\$1187	N/A
Z30L8ER	24 x 30 x 84-84.5	125	334.95	42	\$2013	\$2059	\$1082	N/A
Z24L8ER	24 x 24 x 84-84.5	100	299.24	34.25	\$1946	\$1984	\$934	N/A
Z36M8ER	20 x 36 x 84-84.5	125	332.85	42.25	\$2084	\$2130	\$1187	N/A
Z30M8ER	20 x 30 x 84-84.5	100	298.20	35.50	\$1921	\$1960	\$1082	N/A
Z24M8ER	20 x 24 x 84-84.5	100	266	29	\$1833	\$1865	\$934	N/A

Two file drawers on bottom. Laminate doors are standard. Storage compartment on **right includes three adjustable shelves**. Wardrobe compartment on **left** includes hanging rod and **one adjustable shelf** above rod. Two upper locks secure storage and wardrobe compartments. Lower lock secures all drawers.

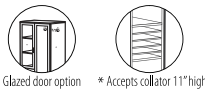
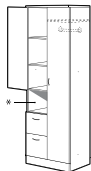

Personal Tower with Doors and cavity - LEFT

Z36L8ECL	24 x 36 x 84-84.5	125	366.44	50	\$2184	\$2237	\$1121	N/A
Z30L8ECL	24 x 30 x 84-84.5	125	332.49	42	\$1992	\$2038	\$1016	N/A
Z24L8ECL	24 x 24 x 84-84.5	100	295.24	34.25	\$1917	\$1954	\$868	N/A
Z36M8ECL	20 x 36 x 84-84.5	125	328.68	42.25	\$2052	\$2098	\$1121	N/A
Z30M8ECL	20 x 30 x 84-84.5	100	295.07	35.50	\$1890	\$1928	\$1016	N/A
Z24M8ECL	20 x 24 x 84-84.5	100	263	29	\$1802	\$1834	\$868	N/A

Two file drawers on bottom. Laminate doors are standard. Storage compartment on **left includes two 3-position fixed/height adjustable shelves**. Wardrobe compartment on **right** includes hanging rod and **one adjustable shelf** above rod. Two upper locks secure storage and wardrobe compartments. Lower lock secures all drawers.

Required Specifications

Finishes
Top/Edge Detail
Handles

Optional Specifications

Glazing - Doors
Collator (Open Shelves)
Box Drawer Option (no upcharge)

PERSONAL TOWERS - 84" / 84.5" HIGH

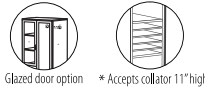
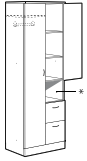

Personal Tower with Doors and cavity - RIGHT

MODEL#	DIMENSIONS D x W x H	FREIGHT CLASS	WT/LBS.	CUBIC FT.	1" TOP	1.5" TOP	GLAZE ADD	HP ADD
Z36L8ECR	24 x 36 x 84-84.5	125	366.44	50	\$2184	\$2237	\$1121	N/A
Z30L8ECR	24 x 30 x 84-84.5	125	332.49	42	\$1992	\$2038	\$1016	N/A
Z24L8ECR	24 x 24 x 84-84.5	100	295.24	34.25	\$1917	\$1954	\$868	N/A
Z36M8ECR	20 x 36 x 84-84.5	125	328.68	42.25	\$2052	\$2098	\$1121	N/A
Z30M8ECR	20 x 30 x 84-84.5	100	295.07	35.50	\$1890	\$1928	\$1016	N/A
Z24M8ECR	20 x 24 x 84-84.5	100	263	29	\$1802	\$1834	\$868	N/A

Two file drawers on bottom. Laminate doors are standard. Storage compartment on right includes two 3-position fixed/height adjustable shelves. Wardrobe compartment on left includes hanging rod and one adjustable shelf above rod. Two upper locks secure storage and wardrobe compartments. Lower lock secures all drawers.

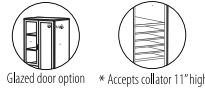
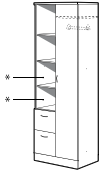

Personal Tower with Open Shelves - LEFT

Z36L8ENL	24 x 36 x 84-84.5	125	351.72	50	\$2066	\$2119	\$685	N/A
Z30L8ENL	24 x 30 x 84-84.5	125	320.22	42	\$1873	\$1919	\$580	N/A
Z24L8ENL	24 x 24 x 84-84.5	100	283.24	34.25	\$1777	\$1814	\$432	N/A
Z36M8ENL	20 x 36 x 84-84.5	125	313.96	42.25	\$1934	\$1980	\$681	N/A
Z30M8ENL	20 x 30 x 84-84.5	125	282.80	35.50	\$1772	\$1810	\$582	N/A
Z24M8ENL	20 x 24 x 84-84.5	100	249	29	\$1664	\$1696	\$432	N/A

Two file drawers on bottom. Laminate door is standard on wardrobe section. Storage compartment on left includes three 3-position fixed/height adjustable shelves. Wardrobe compartment on right includes hanging rod and one adjustable shelf above rod. Upper lock secures wardrobe compartment. Lower lock secures all drawers.

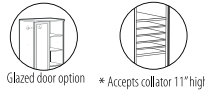
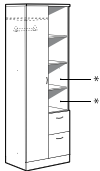

Personal Tower with Open Shelves - RIGHT

Z36L8ENR	24 x 36 x 84-84.5	125	351.72	50	\$2066	\$2119	\$685	N/A
Z30L8ENR	24 x 30 x 84-84.5	125	320.22	42	\$1873	\$1919	\$580	N/A
Z24L8ENR	24 x 24 x 84-84.5	100	283.24	34.25	\$1777	\$1814	\$432	N/A
Z36M8ENR	20 x 36 x 84-84.5	125	313.96	42.25	\$1934	\$1980	\$681	N/A
Z30M8ENR	20 x 30 x 84-84.5	125	282.80	35.50	\$1772	\$1810	\$582	N/A
Z24M8ENR	20 x 24 x 84-84.5	100	249	29	\$1664	\$1696	\$432	N/A

Two file drawers on bottom. Laminate door is standard on wardrobe section. Storage compartment on right includes three 3-position fixed/height adjustable shelves. Wardrobe compartment on right includes hanging rod and one adjustable shelf above rod. Upper lock secures wardrobe compartment. Lower lock secures all drawers.

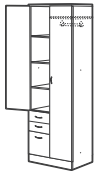

Personal Tower with Doors - LEFT

Z36L8BFL	24 x 36 x 84-84.5	125	371.70	50	\$2309	\$2362	\$1187	N/A
Z30L8BFL	24 x 30 x 84-84.5	100	337.05	42	\$2126	\$2172	\$1082	N/A
Z24L8BFL	24 x 24 x 84-84.5	100	301.24	34.25	\$2024	\$2061	\$934	N/A
Z36M8BFL	20 x 36 x 84-84.5	125	334.95	42.25	\$2178	\$2224	\$1187	N/A
Z30M8BFL	20 x 30 x 84-84.5	100	300.30	35.50	\$2024	\$2063	\$1082	N/A
Z24M8BFL	20 x 24 x 84-84.5	100	268	29	\$1909	\$1941	\$934	N/A

Two box and one file drawer on bottom. Laminate doors are standard. Storage compartment on left includes three 3-position fixed/height adjustable shelves. Wardrobe compartment on right includes hanging rod and one adjustable shelf above rod. Two upper locks secure storage and wardrobe compartments. Lower lock secures all drawers.

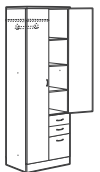

Personal Tower with Doors - RIGHT

Z36L8BFR	24 x 36 x 84-84.5	125	371.70	50	\$2309	\$2362	\$1187	N/A
Z30L8BFR	24 x 30 x 84-84.5	100	337.05	42	\$2126	\$2172	\$1082	N/A
Z24L8BFR	24 x 24 x 84-84.5	100	301.24	34.25	\$2024	\$2061	\$934	N/A
Z36M8BFR	20 x 36 x 84-84.5	125	334.95	42.25	\$2178	\$2224	\$1187	N/A
Z30M8BFR	20 x 30 x 84-84.5	100	300.30	35.50	\$2024	\$2063	\$1082	N/A
Z24M8BFR	20 x 24 x 84-84.5	100	268	29	\$1909	\$1941	\$934	N/A

Two box and one file drawer on bottom. Laminate doors are standard. Storage compartment on right includes three 3-position fixed/height adjustable shelves. Wardrobe compartment on left includes hanging rod and one adjustable shelf above rod. Two upper locks secure storage and wardrobe compartments. Lower lock secures all drawers.

Required Specifications

Finishes
Top/Edge Detail
Handles

Optional Specifications

Glazing - Doors
Collator (Open Shelves)
Box Drawer Option (no upcharge)

PERSONAL TOWERS - 84" / 84.5" HIGH

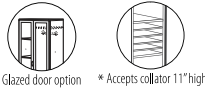
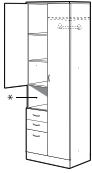

Personal Tower with Doors and Cavity - LEFT

MODEL#	DIMENSIONS D x W x H	FREIGHT CLASS	WT/LBS.	CUBIC FT.	1" TOP	1.5" TOP	GLAZE ADD	HP ADD
Z36L8BFCL	24 x 36 x 84-84.5	125	369.59	50	\$2278	\$2332	\$1121	N/A
Z30L8BFCL	24 x 30 x 84-84.5	125	334.59	42	\$2095	\$2141	\$1016	N/A
Z24L8BFCL	24 x 24 x 84-84.5	100	297.24	34.25	\$1992	\$2030	\$868	N/A
Z36M8BFCL	20 x 36 x 84-84.5	125	330.78	42.25	\$2147	\$2193	\$1121	N/A
Z30M8BFCL	20 x 30 x 84-84.5	100	299.27	35.50	\$1992	\$2031	\$1016	N/A
Z24M8BFCL	20 x 24 x 84-84.5	100	265	29	\$1879	\$1911	\$868	N/A

Two box and one file drawer on bottom. Laminate doors are standard. Storage compartment on **left** includes **two 3-position fixed/height adjustable shelves**. Wardrobe compartment on **left** includes hanging rod and **one adjustable shelf** above rod. Two upper locks secure storage and wardrobe compartments. Lower lock secures all drawers.

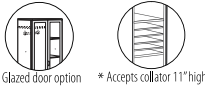
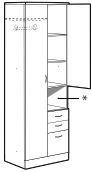

Personal Tower with Doors and Cavity - RIGHT

Z36L8BFCL	24 x 36 x 84-84.5	125	369.59	50	\$2278	\$2332	\$1121	N/A
Z30L8BFCL	24 x 30 x 84-84.5	125	334.59	42	\$2095	\$2141	\$1016	N/A
Z24L8BFCL	24 x 24 x 84-84.5	100	297.24	34.25	\$1992	\$2030	\$868	N/A
Z36M8BFCL	20 x 36 x 84-84.5	125	330.78	42.25	\$2147	\$2193	\$1121	N/A
Z30M8BFCL	20 x 30 x 84-84.5	100	299.27	35.50	\$1992	\$2031	\$1016	N/A
Z24M8BFCL	20 x 24 x 84-84.5	100	265	29	\$1879	\$1911	\$868	N/A

Two box and one file drawer on bottom. Laminate doors are standard. Storage compartment on **right** includes **two 3-position fixed/height adjustable shelves**. Wardrobe compartment on **left** includes hanging rod and **one adjustable shelf** above rod. Two upper locks secure storage and wardrobe compartments. Lower lock secures all drawers.

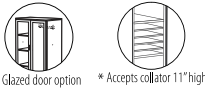
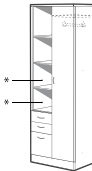

Personal Tower with Open Shelves - LEFT

Z36L8BFNL	24 x 36 x 84-84.5	125	354.87	50	\$2158	\$2212	\$685	N/A
Z30L8BFNL	24 x 30 x 84-84.5	125	322.32	42	\$1976	\$2022	\$580	N/A
Z24L8BFNL	24 x 24 x 84-84.5	100	285.24	34.25	\$1853	\$1890	\$432	N/A
Z36M8BFNL	20 x 36 x 84-84.5	125	316.06	42.25	\$2028	\$2084	\$681	N/A
Z30M8BFNL	20 x 30 x 84-84.5	100	287	35.50	\$1873	\$1912	\$582	N/A
Z24M8BFNL	20 x 24 x 84-84.5	100	251	29	\$1739	\$1771	\$432	N/A

Two box and one file drawer on bottom. Laminate door is standard on wardrobe section. Storage compartment on **left** includes **three 3-position fixed/height adjustable shelves**. Wardrobe compartment on **right** includes hanging rod and **one adjustable shelf** above rod. Upper lock secures storage and wardrobe compartments. Lower lock secures all drawers.

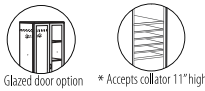
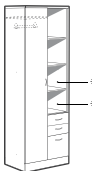

Personal Tower with Open Shelves - RIGHT

Z36L8BFNR	24 x 36 x 84-84.5	125	354.87	50	\$2158	\$2212	\$685	N/A
Z30L8BFNR	24 x 30 x 84-84.5	125	322.32	42	\$1976	\$2022	\$580	N/A
Z24L8BFNR	24 x 24 x 84-84.5	100	285.24	34.25	\$1853	\$1890	\$432	N/A
Z36M8BFNR	20 x 36 x 84-84.5	125	316.06	42.25	\$2028	\$2084	\$681	N/A
Z30M8BFNR	20 x 30 x 84-84.5	100	287	35.50	\$1873	\$1912	\$582	N/A
Z24M8BFNR	20 x 24 x 84-84.5	100	251	29	\$1739	\$1771	\$432	N/A

Two box and one file drawer on bottom. Laminate door is standard on wardrobe section. Storage compartment on **right** includes **three 3-position fixed/height adjustable shelves**. Wardrobe compartment on **left** includes hanging rod and **one adjustable shelf** above rod. Upper lock secures storage and wardrobe compartments. Lower lock secures all drawers.

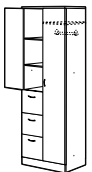

Personal Tower with Doors - LEFT

Z36L83FL	24 x 36 x 84-84.5	125	374.85	50	\$2347	\$2401	\$1121	N/A
Z30L83FL	24 x 30 x 84-84.5	100	340.20	42	\$2166	\$2212	\$1016	N/A
Z24L83FL	24 x 24 x 84-84.5	100	304.24	34.25	\$2079	\$2116	\$868	N/A
Z36M83FL	20 x 36 x 84-84.5	100	339.15	42.25	\$2184	\$2230	\$1121	N/A
Z30M83FL	20 x 30 x 84-84.5	100	306.60	35.50	\$2041	\$2080	\$1016	N/A
Z24M83FL	20 x 24 x 84-84.5	100	272	29	\$1958	\$1991	\$868	N/A

Three file drawers on bottom. Laminate doors are standard. Storage compartment on **left** includes **two 3-position fixed/height adjustable shelves**. Wardrobe compartment on **right** includes hanging rod and **one adjustable shelf** above rod. Two upper locks secure storage and wardrobe compartments. Lower lock secures all drawers.

Required Specifications

Finishes
Top/Edge Detail
Handles

Optional Specifications

Glazing - Doors
Collator (Open Shelves)
Box Drawer Option (no upcharge)

PERSONAL TOWERS - 84" / 84.5" HIGH



Glazed door option

Personal Tower with Doors - RIGHT

MODEL#	DIMENSIONS D x W x H	FREIGHT CLASS	WT/LBS.	CUBIC FT.	1" TOP	1.5" TOP	GLAZE ADD	HP ADD
Z36L83FR	24 x 36 x 84-84.5	125	374.85	50	\$2347	\$2401	\$1121	N/A
Z30L83FR	24 x 30 x 84-84.5	100	340.20	42	\$2166	\$2212	\$1016	N/A
Z24L83FR	24 x 24 x 84-84.5	100	304.24	34.25	\$2079	\$2116	\$868	N/A
Z36M83FR	20 x 36 x 84-84.5	100	339.15	42.25	\$2184	\$2230	\$1121	N/A
Z30M83FR	20 x 30 x 84-84.5	100	306.60	35.50	\$2041	\$2080	\$1016	N/A
Z24M83FR	20 x 24 x 84-84.5	100	272	29	\$1958	\$1991	\$868	N/A

Three file drawers on bottom. Laminate doors are standard. Storage compartment on **right includes two 3-position fixed/height adjustable shelves**. Wardrobe compartment on **left** includes hanging rod and **one adjustable shelf** above rod. Two upper locks secure storage and wardrobe compartments. Lower lock secures all drawers.

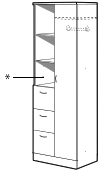

Glazed door option



* Accepts collator 11" high

Personal Tower with Open Shelves - LEFT

Z36L83FNL	24 x 36 x 84-84.5	125	362.01	50	\$2228	\$2282	\$685	N/A
Z30L83FNL	24 x 30 x 84-84.5	125	328.80	42	\$2046	\$2092	\$580	N/A
Z24L83FNL	24 x 24 x 84-84.5	100	291.24	34.25	\$1939	\$1977	\$432	N/A
Z36M83FNL	20 x 36 x 84-84.5	125	324.25	42.25	\$2066	\$2112	\$681	N/A
Z30M83FNL	20 x 30 x 84-84.5	100	294.53	35.50	\$1922	\$1961	\$582	N/A
Z24M83FNL	20 x 24 x 84-84.5	100	258	29	\$1818	\$1850	\$432	N/A

Three file drawers on bottom. Laminate door is standard on wardrobe section. Storage compartment on **left includes two 3-position fixed/height adjustable shelves**. Wardrobe compartment on **right** includes hanging rod and **one adjustable shelf** above rod. Upper lock secures wardrobe compartment. Lower lock secures all drawers.

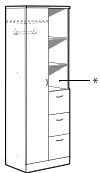

Glazed door option



* Accepts collator 11" high

Personal Tower with Open Shelves - RIGHT

Z36L83FNR	24 x 36 x 84-84.5	125	362.01	50	\$2228	\$2282	\$685	N/A
Z30L83FNR	24 x 30 x 84-84.5	125	328.80	42	\$2046	\$2092	\$580	N/A
Z24L83FNR	24 x 24 x 84-84.5	100	291.24	34.25	\$1939	\$1977	\$432	N/A
Z36M83FNR	20 x 36 x 84-84.5	125	324.25	42.25	\$2066	\$2112	\$681	N/A
Z30M83FNR	20 x 30 x 84-84.5	100	294.53	35.50	\$1922	\$1961	\$582	N/A
Z24M83FNR	20 x 24 x 84-84.5	100	258	29	\$1818	\$1850	\$432	N/A

Three file drawers on bottom. Laminate door is standard on wardrobe section. Storage compartment on **right includes two 3-position fixed/height adjustable shelves**. Wardrobe compartment on **left** includes hanging rod and **one adjustable shelf** above rod. Upper lock secures wardrobe compartment. Lower lock secures all drawers.

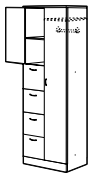

Glazed door option

Personal Tower with Doors - LEFT

Z36L84FL	24 x 36 x 84-84.5	125	380.10	50	\$2421	\$2475	\$1026	N/A
Z30L84FL	24 x 30 x 84-84.5	100	344.40	42	\$2239	\$2285	\$920	N/A
Z24L84FL	24 x 24 x 84-84.5	100	309.24	34.25	\$2098	\$2135	\$772	N/A
Z36M84FL	20 x 36 x 84-84.5	100	344.40	42.25	\$2262	\$2308	\$1026	N/A
Z30M84FL	20 x 30 x 84-84.5	100	312.90	35.50	\$2118	\$2157	\$920	N/A
Z24M84FL	20 x 24 x 84-84.5	100	278	29	\$2001	\$2034	\$772	N/A

Four file drawers on bottom. Laminate doors are standard. Storage compartment on **left includes one 3-position fixed/height adjustable shelf**. Wardrobe compartment on **right** includes hanging rod and **one adjustable shelf** above rod. Two upper locks secure wardrobe compartment. Lower lock secures all drawers.



Glazed door option

Personal Tower with Doors - RIGHT

Z36L84FR	24 x 36 x 84-84.5	125	380.10	50	\$2421	\$2475	\$1026	N/A
Z30L84FR	24 x 30 x 84-84.5	100	344.40	42	\$2239	\$2285	\$920	N/A
Z24L84FR	24 x 24 x 84-84.5	100	309.24	34.25	\$2098	\$2135	\$772	N/A
Z36M84FR	20 x 36 x 84-84.5	100	344.40	42.25	\$2262	\$2308	\$1026	N/A
Z30M84FR	20 x 30 x 84-84.5	100	312.90	35.50	\$2118	\$2157	\$920	N/A
Z24M84FR	20 x 24 x 84-84.5	100	278	29	\$2001	\$2034	\$772	N/A

Four file drawers on bottom. Laminate doors are standard. Storage compartment on **right includes one 3-position fixed/height adjustable shelf**. Wardrobe compartment on **left** includes hanging rod and **one adjustable shelf** above rod. Two upper locks secure wardrobe compartment. Lower lock secures all drawers.

Required Specifications

Finishes
Top/Edge Detail
Handles

Optional Specifications

Glazing - Doors
Collator (Open Shelves)
Box Drawer Option (no upcharge)

PERSONAL TOWERS - 84" / 84.5" HIGH

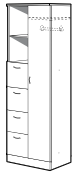

Glazed door option

Personal Tower with Open Shelf - LEFT

MODEL#	DIMENSIONS D x W x H	FREIGHT CLASS	WT./LBS.	CUBIC FT.	1" TOP	1.5" TOP	GLAZE ADD	HP ADD
Z36L84FNL	24 x 36 x 84-84.5	125	371.25	50	\$2323	\$2377	\$685	N/A
Z30L84FNL	24 x 30 x 84-84.5	100	336.33	42	\$2141	\$2187	\$580	N/A
Z24L84FNL	24 x 24 x 84-84.5	100	299.24	34.25	\$2010	\$2058	\$432	N/A
Z36M84FNL	20 x 36 x 84-84.5	125	328.24	42.25	\$2166	\$2212	\$681	N/A
Z30M84FNL	20 x 30 x 84-84.5	100	297.86	35.50	\$2022	\$2061	\$582	N/A
Z24M84FNL	20 x 24 x 84-84.5	100	268	29	\$1914	\$1947	\$432	N/A

Four file drawers on bottom. Laminate door is standard on wardrobe section. Storage compartment on left includes one 3-position fixed/height adjustable shelf. Wardrobe compartment on right includes hanging rod and one adjustable shelf above rod. Upper lock secures wardrobe compartment. Lower lock secures all drawers.



Glazed door option

Personal Tower with Open Shelf - RIGHT

Z36L84FNR	24 x 36 x 84-84.5	125	371.25	50	\$2323	\$2377	\$685	N/A
Z30L84FNR	24 x 30 x 84-84.5	100	336.33	42	\$2141	\$2187	\$580	N/A
Z24L84FNR	24 x 24 x 84-84.5	100	299.24	34.25	\$2010	\$2058	\$432	N/A
Z36M84FNR	20 x 36 x 84-84.5	125	328.24	42.25	\$2166	\$2212	\$681	N/A
Z30M84FNR	20 x 30 x 84-84.5	100	297.86	35.50	\$2022	\$2061	\$582	N/A
Z24M84FNR	20 x 24 x 84-84.5	100	268	29	\$1914	\$1947	\$432	N/A

Four file drawers on bottom. Laminate door is standard on wardrobe section. Storage compartment on right includes one 3-position fixed/height adjustable shelf. Wardrobe compartment on left includes hanging rod and one adjustable shelf above rod. Upper lock secures wardrobe compartment. Lower lock secures all drawers.

OVERHEAD STORAGE

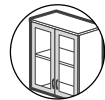
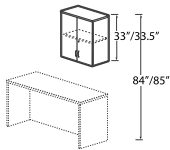

Glazed door option

Closed Front Overhead Storage with Doors - 33"/33.5" High

Z42S33OS	16 x 42 x 32.5-33	100	135.98	16.25	\$806	\$858	\$782	N/A
Z36S33OS	16 x 36 x 32.5-33	100	119.70	14	\$732	\$777	\$705	N/A
Z30S33OS	16 x 30 x 32.5-33	100	104.42	11.75	\$654	\$682	\$615	N/A
Z24S33OS	16 x 24 x 32.5-33	100	81.13	9.75	\$586	\$617	\$537	N/A

Includes steel hanging rail for wall mount applications. Includes one fixed shelf. Doors lock.

• **NOTE:** Care should be taken to mount the units. Units should be mounted to wall studs using correct fasteners. Failure to do so may result in collapse of the unit and subsequent personal injury. **Fastening hardware not included.** Mounting hardware used should be based on wall material. Consult an installation professional for proper wall mounting.

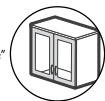
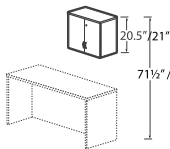

Glazed door option

Closed Front Overhead Storage with Doors - 20.5"/21" High

Z42S20OS	16 x 42 x 20-20.5	100	93.99	10.50	\$576	\$627	\$557	N/A
Z36S20OS	16 x 36 x 20-20.5	100	82.70	9	\$527	\$572	\$509	N/A
Z30S20OS	16 x 30 x 20-20.5	100	72.42	7.50	\$476	\$504	\$452	N/A
Z24S20OS	16 x 24 x 20-20.5	100	56.13	6.25	\$446	\$478	\$403	N/A

Includes steel hanging rail for wall mount applications. Doors lock.

• **NOTE:** Care should be taken to mount the units. Units should be mounted to wall studs using correct fasteners. Failure to do so may result in collapse of the unit and subsequent personal injury. **Fastening hardware not included.** Mounting hardware used should be based on wall material. Consult an installation professional for proper wall mounting.

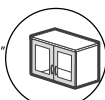
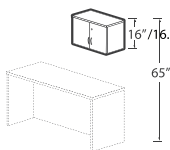

Glazed door option

Closed Front Overhead Storage with Doors - 16"/16.5" High

Z48S16OS	16 x 48 x 16-16.5	92.5	98.63	9.25	\$574	\$622	\$537	N/A
Z42S16OS	16 x 42 x 16-16.5	92.5	87.42	7.75	\$498	\$539	\$520	N/A
Z36S16OS	16 x 36 x 16-16.5	92.5	77.22	6.75	\$454	\$490	\$469	N/A
Z30S16OS	16 x 30 x 16-16.5	92.5	64.02	5.75	\$414	\$446	\$411	N/A

Standard with pre-mounted "J" bracket for wall mount applications. Doors lock.

• **NOTE:** Care should be taken to mount the units. Units should be mounted to wall studs using correct fasteners. Failure to do so may result in collapse of the unit and subsequent personal injury. **Fastening hardware not included.** Mounting hardware used should be based on wall material. Consult an installation professional for proper wall mounting.

Required Specifications

Finishes
Top/Edge Detail
Handles

Optional Specifications

Glazing - Doors
Box Drawer Option (no upcharge - Towers)

OVERHEAD STORAGE

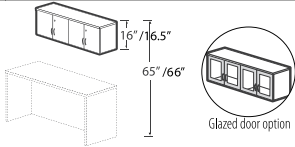

Closed Front Overhead Storage with Doors - 16\"/>

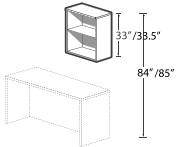

Open Front Overhead Storage 33\"/>

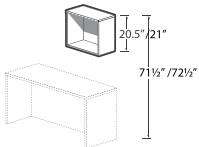

Open Front Overhead Storage 20.5\"/>

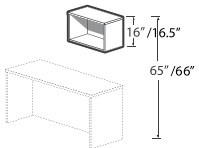

Open Front Overhead Storage 16\"/>

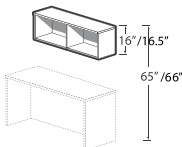

Open Front Overhead Storage 16\"/>

MODEL#	DIMENSIONS	FREIGHT CLASS	WT/LBS.	CUBIC FT.	1\"/>
--------	------------	---------------	---------	-----------	-------

D x W x H

Z60S160S	16 x 60 x 16-16.5	92.5	118.03	11	\$755	\$813	\$821	N/A
Z42S330SN	16 x 42 x 32.5-33	125	108.98	16.25	\$545	\$597	N/A	N/A
Z36S330SN	16 x 36 x 32.5-33	125	96.70	14	\$495	\$540	N/A	N/A
Z30S330SN	16 x 30 x 32.5-33	125	84.42	11.75	\$443	\$471	N/A	N/A
Z24S330SN	16.2 x 24 x 32.5-33	125	67.20	9.75	\$408	\$440	N/A	N/A

Standard with pre-mounted "J" bracket for wall mount applications. Doors lock.

- **NOTE:** Care should be taken to mount the units. Units should be mounted to wall studs using correct fasteners. Failure to do so may result in collapse of the unit and subsequent personal injury. **Fastening hardware not included.** Mounting hardware used should be based on wall material. Consult an installation professional for proper wall mounting.

Includes steel hanging rail for wall mount applications. Includes one fixed shelf.

- **NOTE:** Care should be taken to mount the units. Units should be mounted to wall studs using correct fasteners. Failure to do so may result in collapse of the unit and subsequent personal injury. **Fastening hardware not included.** Mounting hardware used should be based on wall material. Consult an installation professional for proper wall mounting.

Z42S200SN	16 x 42 x 20-20.5	125	77.98	10.50	\$380	\$432	N/A	N/A
Z36S200SN	16 x 36 x 20-20.5	125	69.70	9	\$344	\$389	N/A	N/A
Z30S200SN	16 x 30 x 20-20.5	100	60.42	7.50	\$309	\$337	N/A	N/A
Z24S200SN	16 x 24 x 20-20.5	125	48.13	6.25	\$279	\$311	N/A	N/A

Includes steel hanging rail for wall mount applications.

- **NOTE:** Care should be taken to mount the units. Units should be mounted to wall studs using correct fasteners. Failure to do so may result in collapse of the unit and subsequent personal injury. **Fastening hardware not included.** Mounting hardware used should be based on wall material. Consult an installation professional for proper wall mounting.

Z48S160SN	16 x 48 x 16-16.5	100	79.63	9.25	\$380	\$428	N/A	N/A
Z42S160SN	16 x 42 x 16-16.5	100	70.42	7.75	\$331	\$373	N/A	N/A
Z36S160SN	16 x 36 x 16-16.5	100	63.22	6.75	\$304	\$340	N/A	N/A
Z30S160SN	16 x 30 x 16-16.5	100	54.02	5.75	\$277	\$308	N/A	N/A

Standard with pre-mounted "J" bracket for wall mount applications. Shipped RTA (ready to assemble).

- **NOTE:** Care should be taken to mount the units. Units should be mounted to wall studs using correct fasteners. Failure to do so may result in collapse of the unit and subsequent personal injury. **Fastening hardware not included.** Mounting hardware used should be based on wall material. Consult an installation professional for proper wall mounting.

Z60S160SN	16 x 60 x 16-16.5	100	98.03	11	\$469	\$527	N/A	N/A
-----------	-------------------	-----	-------	----	--------------	--------------	-----	-----

Standard with pre-mounted "J" bracket for wall mount applications. Shipped RTA (ready to assemble).

- **NOTE:** Care should be taken to mount the units. Units should be mounted to wall studs using correct fasteners. Failure to do so may result in collapse of the unit and subsequent personal injury. **Fastening hardware not included.** Mounting hardware used should be based on wall material. Consult an installation professional for proper wall mounting.

Required Specifications

Finishes
Top/Edge Detail
Handles

Optional Specifications

Glazing - Doors (Closed Storage)

OPEN HUTCHES

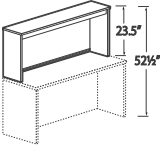

Open Hutch with Closed Back 23.5" High

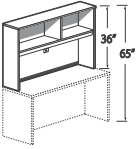

Open Hutch with Closed Back 36" High

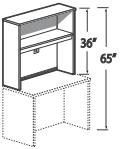

Open Hutch with Closed Back 36" High

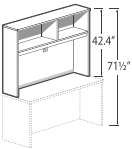

Open Hutch with Closed Back 42.4" High

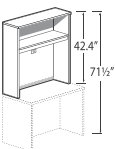

Open Hutch with Closed Back 42.4" High

MODEL#	DIMENSIONS D x W x H	FREIGHT CLASS	WT/LBS.	CUBIC FT.	1" TOP	1.5" TOP	GLAZE ADD	HP ADD
Z84S23HN	15 x 84 x 23-23.5	150	129	23	\$688	\$768	N/A	N/A
Z72S23HN	15 x 72 x 23-23.5	150	114	19.75	\$603	\$682	N/A	N/A
Z71S23HN	15 x 71.63 x 23-23.5	150	113	19.75	\$603	\$672	N/A	N/A
Z66S23HN	15 x 66 x 23-23.5	150	106	18.25	\$553	\$616	N/A	N/A
Z60S23HN	15 x 60 x 23-23.5	125	99	16.50	\$489	\$548	N/A	N/A
Z48S23HN	15 x 48 x 23-23.5	125	84	13.50	\$423	\$471	N/A	N/A
Z42S23HN	15 x 42 x 23-23.5	125	76	11.75	\$393	\$434	N/A	N/A
Z36S23HN	15 x 36 x 23-23.5	125	68	10.25	\$363	\$400	N/A	N/A
Z30S23HN	15 x 30 x 23-23.5	125	61	8.50	\$336	\$371	N/A	N/A

Closed back features one grommet and flexible sweep for wire management. All hutches shipped pre-assembled.

- Clearance from worksurface to valance is 20.25".
- Woodgrain runs horizontal on both the upper and lower back panels.

Z84S36HN	15 x 84 x 35.5-36	125	206	33	\$893	\$973	N/A	N/A
Z72S36HN	15 x 72 x 35.5-36	125	181	28.25	\$818	\$887	N/A	N/A
Z71S36HN	15 x 71.63 x 35.5-36	125	173	28.25	\$810	\$880	N/A	N/A
Z66S36HN	15 x 66 x 35.5-36	125	161	26	\$766	\$831	N/A	N/A
Z60S36HN	15 x 60 x 35.5-36	125	150	23.75	\$716	\$774	N/A	N/A

One fixed shelf **and fixed shelf divider**. Closed back features one grommet and flexible sweep for wire management. All hutches shipped pre-assembled.

- Clearance from worksurface to valance is 17.75".
- Woodgrain runs horizontal on both the upper and lower back panels.

Z48S36HN	15 x 48 x 35.5-36	125	123	19	\$591	\$639	N/A	N/A
Z42S36HN	15 x 42 x 35.5-36	125	112	16.75	\$546	\$587	N/A	N/A
Z36S36HN	15 x 36 x 35.5-36	125	100	14.50	\$500	\$536	N/A	N/A
Z30S36HN	15 x 30 x 35.5-36	125	89	12.25	\$456	\$487	N/A	N/A

One fixed shelf. Closed back features one grommet and flexible sweep for wire management. All hutches shipped pre-assembled.

- Clearance from worksurface to valance is 17.75".
- Woodgrain runs horizontal on both the upper and lower back panels.

Z84S42HN	15 x 84 x 41.9-42.4	150	223	38.50	\$953	\$1033	N/A	N/A
Z72S42HN	15 x 72 x 41.9-42.4	150	196	33	\$881	\$950	N/A	N/A
Z71S42HN	15 x 71.63 x 41.9-42.4	150	188	33	\$876	\$945	N/A	N/A
Z66S42HN	15 x 66 x 41.9-42.4	150	175	30.75	\$824	\$887	N/A	N/A
Z60S42HN	15 x 60 x 41.9-42.4	150	164	27.75	\$771	\$829	N/A	N/A

One fixed shelf **and fixed shelf divider**. Closed back features one grommet and flexible sweep for wire management. All hutches shipped pre-assembled.

- Clearance from worksurface to valance is 24.25".
- Woodgrain runs horizontal on both the upper and lower back panels.

Z48S42HN	15 x 48 x 41.9-42.4	125	134	22.25	\$640	\$688	N/A	N/A
Z42S42HN	15 x 42 x 41.9-42.4	125	123	19.50	\$591	\$633	N/A	N/A
Z36S42HN	15 x 36 x 41.9-42.4	125	110	17	\$541	\$577	N/A	N/A
Z30S42HN	15 x 30 x 41.9-42.4	125	105	14.25	\$490	\$522	N/A	N/A

One fixed shelf. Closed back features one grommet and flexible sweep for wire management. All hutches shipped pre-assembled.

- Clearance from worksurface to valance is 24.25".
- Woodgrain runs horizontal on both the upper and lower back panels.

Required Specifications

Finishes
Top/Edge Detail

Accessories

Tackboard
Pigeon-Hole Storage

OPEN HUTCHES

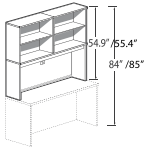

Open Hutch with Closed Back
54.9\"/>

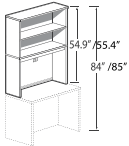

Open Hutch with Closed Back
54.9\"/>

MODEL#	DIMENSIONS	FREIGHT CLASS	WT/LBS.	CUBIC FT.	1\"/>			
Z84S55HN	15 x 84 x 54.4-54.9	300	306	62.50	\$1564	\$1647	N/A	N/A
Z72S55HN	15 x 72 x 54.4-54.9	300	272	53.75	\$1459	\$1531	N/A	N/A
Z71S55HN	15 x 71.63 x 54.4-54.9	300	271	53.75	\$1452	\$1525	N/A	N/A
Z66S55HN	15 x 66 x 54.4-54.9	300	254	49.50	\$1402	\$1473	N/A	N/A
Z60S55HN	15 x 60 x 54.4-54.9	300	238	45.25	\$1255	\$1316	N/A	N/A

One fixed shelf and one adjustable shelf (per compartment). Closed back features one grommet and flexible sweep for wire management. Shipped RTA (ready to assemble).

- Clearance from worksurface to valance is 24.25\"/>

Z48S55HN	15 x 48 x 54.4-54.9	250	183	36	\$944	\$992	N/A	N/A
Z42S55HN	15 x 42 x 54.4-54.9	250	168	31.50	\$873	\$915	N/A	N/A
Z36S55HN	15 x 36 x 54.4-54.9	250	149	23.25	\$795	\$831	N/A	N/A
Z30S55HN	15 x 30 x 54.4-54.9	250	132	23	\$721	\$754	N/A	N/A

One fixed shelf and one adjustable shelf. Closed back features one grommet and flexible sweep for wire management. Shipped RTA (ready to assemble).

- Clearance from worksurface to valance is 24.25\"/>

CLOSED HUTCHES

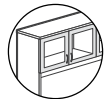
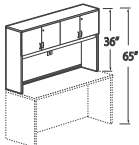

Glazed door option

Closed Hutch with Doors 36\"/>

Z84S36H	15 x 84 x 35.5-36	125	231	33	\$1226	\$1307	\$981	N/A
Z72S36H	15 x 72 x 35.5-36	125	201	28.25	\$1141	\$1211	\$896	N/A
Z71S36H	15 x 71.63 x 35.5-36	125	193	28.25	\$1132	\$1202	\$894	N/A
Z66S36H	15 x 66 x 35.5-36	125	179	26	\$1075	\$1140	\$852	N/A
Z60S36H	15 x 60 x 35.5-36	125	167	23.75	\$1002	\$1060	\$801	N/A

One fixed shelf **and fixed shelf divider**. Closed back features one grommet and flexible sweep for wire management. Doors lock. All hutches shipped pre-assembled.

- Clearance from worksurface to valance is 17.75\"/>

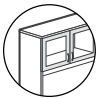
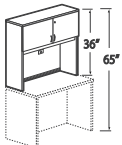

Glazed door option

Closed Hutch with Doors 36\"/>

Z48S36H	15 x 48 x 35.5-36	125	136	19	\$785	\$833	\$508	N/A
Z42S36H	15 x 42 x 35.5-36	125	124	16.75	\$712	\$754	\$491	N/A
Z36S36H	15 x 36 x 35.5-36	125	110	14.50	\$651	\$687	\$449	N/A
Z30S36H	15 x 30 x 35.5-36	100	98	12.25	\$594	\$626	\$401	N/A

One fixed shelf. Closed back features one grommet and flexible sweep for wire management. Doors lock. All hutches shipped pre-assembled.

- Clearance from worksurface to valance is 17.75\"/>

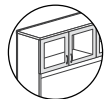
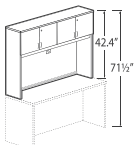

Glazed door option

Closed Hutch with Doors 42.4\"/>

Z84S42H	15 x 84 x 41.9-42.4	125	247	38.50	\$1362	\$1443	\$981	N/A
Z72S42H	15 x 72 x 41.9-42.4	125	217	33	\$1207	\$1276	\$896	N/A
Z71S42H	15 x 71.63 x 41.9-42.4	125	207	33	\$1199	\$1268	\$894	N/A
Z66S42H	15 x 66 x 41.9-42.4	125	194	30.75	\$1133	\$1198	\$852	N/A
Z60S42H	15 x 60 x 41.9-42.4	125	180	27.75	\$1058	\$1116	\$801	N/A

One fixed shelf **and fixed shelf divider**. Closed back features one grommet and flexible sweep for wire management. Doors lock. All hutches shipped pre-assembled.

- Clearance from worksurface to valance is 24.25\"/>

Required Specifications

Finishes
Top/Edge Detail
Handles (Doors)

Optional Specifications

Glazing - Doors

Accessories

Tackboard
Pigeon-Hole Storage

CLOSED HUTCHES

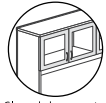
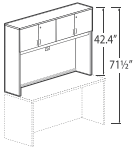

Glazed door option

Closed Hutch with Doors 42.4" High

MODEL#	DIMENSIONS D x W x H	FREIGHT CLASS	WT./LBS.	CUBIC FT.	1" TOP	1.5" TOP	GLAZE ADD	HP ADD
Z48S42H	15 x 48 x 41.9-42.4	125	148	22.25	\$835	\$883	\$508	N/A
Z42S42H	15 x 42 x 41.9-42.4	125	134	19.50	\$756	\$798	\$491	N/A
Z36S42H	15 x 36 x 41.9-42.4	125	120	17	\$691	\$728	\$449	N/A
Z30S42H	15 x 30 x 41.9-42.4	125	106	14.25	\$634	\$665	\$401	N/A

One fixed shelf. Closed back features one grommet and flexible sweep for wire management. Doors lock. All hutches shipped pre-assembled.

- Clearance from worksurface to valance is 24.25".
- Woodgrain runs horizontal on both the upper and lower back panels.

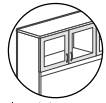
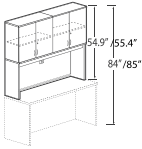

Glazed door option

Closed Hutch w/Doors 54.9"/55.4" High

Z84S55H	15 x 84 x 54.4-54.9	300	349	62.50	\$2067	\$2150	\$1426	N/A
Z72S55H	15 x 72 x 54.4-54.9	300	308	53.75	\$1863	\$1945	\$1289	N/A
Z71S55H	15 x 71.63 x 54.4-54.9	300	307	53.75	\$1856	\$1929	\$1273	N/A
Z66S55H	15 x 66 x 54.4-54.9	300	287	49.50	\$1756	\$1828	\$1214	N/A
Z60S55H	15 x 60 x 54.4-54.9	300	269	45.25	\$1614	\$1675	\$1129	N/A

One fixed shelf and one adjustable shelf (per compartment). Closed back features one grommet and flexible sweep for wire management. Doors lock. Shipped RTA (ready to assemble).

- Clearance from worksurface to valance is 24.25".
- Woodgrain runs horizontal on both the upper and lower back panels.

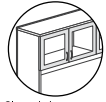
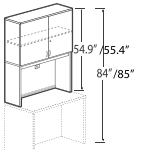

Glazed door option

Closed Hutch w/Doors 54.9"/55.4" High

Z48S55H	15 x 48 x 54.4-54.9	250	207	36	\$1200	\$1237	\$786	N/A
Z42S55H	15 x 42 x 54.4-54.9	250	188	31.50	\$1095	\$1137	\$713	N/A
Z36S55H	15 x 36 x 54.4-54.9	250	167	27.25	\$997	\$1033	\$645	N/A
Z30S55H	15 x 30 x 54.4-54.9	250	148	23	\$901	\$932	\$565	N/A

One fixed shelf and one adjustable shelf. Closed back features one grommet and flexible sweep for wire management. Doors lock. Shipped RTA (ready to assemble).

- Clearance from worksurface to valance is 24.25".
- Woodgrain runs horizontal on both the upper and lower back panels.

PIGEON-HOLE STORAGE

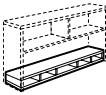
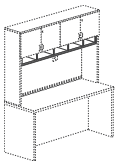

Horizontal Pigeon-Hole Storage

ZHS72	12 x 69.96 x 5.66	70	49	3	\$534	N/A	N/A	N/A
ZHS71	12 x 69.64 x 5.66	70	49	3	\$534	N/A	N/A	N/A
ZHS66	12 x 63.93 x 5.66	70	46	2.80	\$505	N/A	N/A	N/A
ZHS60	12 x 57.95 x 5.66	70	42	2.50	\$482	N/A	N/A	N/A
ZHS48	12 x 45.94 x 5.66	70	33	2	\$360	N/A	N/A	N/A
ZHS42	12 x 39.96 x 5.66	85	29	2	\$337	N/A	N/A	N/A
ZHS36	12 x 33.93 x 5.66	85	26	2	\$317	N/A	N/A	N/A

For additional storage. Can be **top** or **bottom** mounted. For use inside hutch. Shipped RTA (ready to assemble).

- *Cannot be used on Overstorage Units.*
- Available in all standard laminate finishes (see page 137)

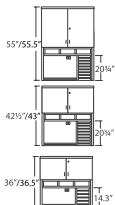
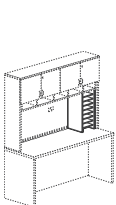

Vertical Pigeon-Hole Storage

ZVS21	11.8 x 13.42 x 20.75	70	30	1.80	\$266	N/A	N/A	N/A
ZVS14	11.8 x 13.42 x 14.3	85	24	1.80	\$215	N/A	N/A	N/A

For use in conjunction with the Horizontal Pigeon-Hole Storage. Can be used **under** or **over** horizontal unit. Not freestanding. Shipped RTA (ready to assemble).

- Vertical Pigeon-Hole Shell - Available in all standard laminate finishes (see page 137).
- Collator Shelves - Available in Black (**K**) or Brushed Cobalt (**T**) finish. Please Specify.
Use Brushed Cobalt to match silver finish handles.

Required Specifications

Finishes
Top/Edge Detail (Hutches)
Handles (Doors)

Optional Specifications

Glazing - Doors

Accessories

Tackboard (Hutches)
Pigeon-Hole Storage (Hutches)

PIGEON-HOLE STORAGE

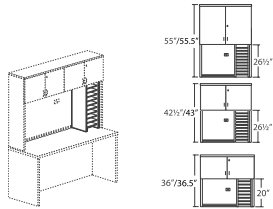

Vertical Pigeon-Hole Storage

MODEL#	DIMENSIONS	FREIGHT CLASS	WT/LBS.	CUBIC FT.	1" TOP	1.5" TOP	GLAZE ADD	HP ADD
ZVS26	11.8 x 13.42 x 25.4-25.970		36	1.80	\$319	N/A	N/A	N/A
ZVS20	11.8 x 13.42 x 19-19.5	70	29	1.80	\$256	N/A	N/A	N/A

Used alone with a hutch. Not freestanding. Shipped RTA (ready to assemble).

- Vertical Pigeon-Hole Shell - Available in all standard laminate finishes (see page 137).
- Collator Shelves - Available in Black (K) or Brushed Cobalt (T) finish. Please Specify. Use Brushed Cobalt to match silver finish handles.

TRANSITIONAL PIGEON-HOLE STORAGE

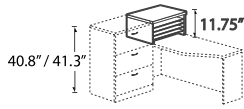

Transitional Pigeon-Hole Storage
11.75" High

Z24L12PH	24 x 24 x 11.25-11.75	65	63	2.70	\$527	\$579	N/A	N/A
Z20L12PH	24 x 20 x 11.25-11.75	70	56	2.70	\$465	\$509	N/A	N/A
Z16L12PH	24 x 16 x 11.25-11.75	65	46	1.60	\$426	\$463	N/A	N/A
Z24M12PH	20 x 24 x 11.25-11.75	70	55	2.70	\$465	\$509	N/A	N/A
Z20M12PH	20 x 20 x 11.25-11.75	70	48	2.70	\$412	\$447	N/A	N/A
Z16M12PH	20 x 16 x 11.25-11.75	65	40	1.60	\$374	\$405	N/A	N/A
Z24S12PH	16 x 24 x 11.25-11.75	65	43	1.60	\$428	\$464	N/A	N/A
Z20S12PH	16 x 20 x 11.25-11.75	65	38	1.60	\$376	\$406	N/A	N/A
Z16S12PH	16 x 16 x 11.25-11.75	70	33	1.60	\$352	\$378	N/A	N/A

Designed to fit on top of returns and transition worksurface to match 40.8"/41.3" high storage modules. Pigeon-hole shell and four collator shelves. Shipped RTA (ready to assemble).

- Pigeon-Hole Shell - Available in all standard laminate finishes (see page 137).
- Collator Shelves - Available in Black (K) or Brushed Cobalt (T) finish. Please Specify. Use Brushed Cobalt to match silver finish handles.

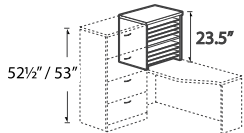

Transitional Pigeon-Hole Storage
23.5" High

Z24L23PH	24 x 24 x 23-23.5	60	101	2.70	\$951	\$1003	N/A	N/A
Z20L23PH	24 x 20 x 23-23.5	60	88	2.70	\$832	\$874	N/A	N/A
Z16L23PH	24 x 16 x 23-23.5	65	76	2.70	\$780	\$817	N/A	N/A
Z24M23PH	20 x 24 x 23-23.5	60	87	2.70	\$834	\$876	N/A	N/A
Z20M23PH	20 x 20 x 23-23.5	65	76	2.70	\$730	\$765	N/A	N/A
Z16M23PH	20 x 16 x 23-23.5	60	64	1.60	\$669	\$700	N/A	N/A
Z24S23PH	16 x 24 x 23-23.5	65	74	2.70	\$788	\$824	N/A	N/A
Z20S23PH	16 x 20 x 23-23.5	65	65	2.70	\$688	\$719	N/A	N/A
Z16S23PH	16 x 16 x 23-23.5	60	54	1.60	\$630	\$657	N/A	N/A

Designed to fit on top of returns and transition worksurface to match 52.5"/53" high storage modules. Pigeon-hole shell and eight collator shelves. Shipped RTA (ready to assemble).

- Pigeon-Hole Shell - Available in all standard laminate finishes (see page 137).
- Collator Shelves - Available in Black (K) or Brushed Cobalt (T) finish. Please Specify. Use Brushed Cobalt to match silver finish handles.

TACKBOARDS FOR HUTCHES - 23.5" / 24" HIGH

TACKBOARD Notes: Tackboards can be upholstered in all of the following fabrics:

Grade 1: Agate II, Drama, Jenny, Pebbles, Quilt, Sprinkle, Station, Urban

Grade 2: Couture, Crescent, Cumulus, Imprint, Lola, Match, Oxygen, Quantum, Renewal, Replay, Silhouette

Grade 3: Brinx, Mariposa

Grade 4: Accent

Grade 5: Meander, Tracery, Universe

Required Specifications

Finishes (Shell & Collator)
Top/Edge Detail

TACKBOARDS FOR HUTCHES - 23.5" / 24" HIGH

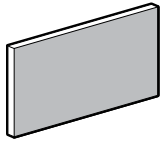

Tackboard

MODEL#	DIMENSIONS D x W x H	FREIGHT CLASS	WT/LBS.	CUBIC FT.	FABRIC GRADE	LIST PRICE
ZTB8217	.62 x 82 x 17	150	8.20	2	1	\$516
					2	\$618
					3	\$741
					4	\$886
					5	\$1019

For use on **Z84S23HN** hutch. Includes mounting screws.

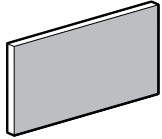

Tackboard

ZTB7017	.62 x 70 x 17	150	7	1.30	1	\$343
					2	\$412
					3	\$495
					4	\$589
					5	\$678

For use on **Z72S23HN** hutch. Includes mounting screws.

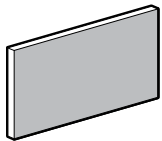

Tackboard

ZTB6917	.62 x 69 x 17	150	7	1.30	1	\$340
					2	\$408
					3	\$491
					4	\$584
					5	\$672

For use on **Z71S23HN** hutch. Includes mounting screws.

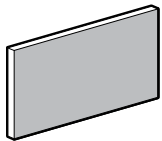

Tackboard

ZTB6417	.62 x 64 x 17	150	6.40	1.30	1	\$337
					2	\$404
					3	\$483
					4	\$576
					5	\$663

For use on **Z66S23HN** hutch. Includes mounting screws.

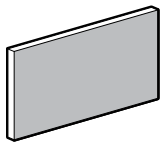

Tackboard

ZTB5817	.62 x 58 x 17	150	5.80	1.08	1	\$329
					2	\$394
					3	\$474
					4	\$564
					5	\$649

For use on **Z60S23HN** hutch. Includes mounting screws.

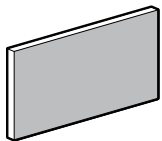

Tackboard

ZTB4617	.62 x 46 x 17	150	4.60	.85	1	\$219
					2	\$263
					3	\$315
					4	\$374
					5	\$431

For use on **Z48S23HN** hutch. Includes mounting screws.

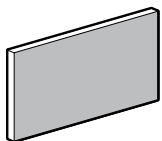

Tackboard

ZTB4017	.62 x 40 x 17	150	4	.85	1	\$212
					2	\$253
					3	\$304
					4	\$360
					5	\$414

For use on **Z42S23HN** hutch. Includes mounting screws.

Required Specifications

Fabric

TACKBOARDS FOR HUTCHES - 23.5" / 24" HIGH

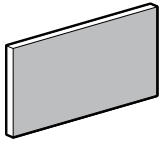

Tackboard

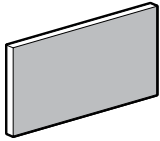

Tackboard

MODEL# DIMENSIONS FREIGHT CLASS WT/LBS. CUBIC FT. FABRIC GRADE LIST PRICE

D x W x H	
ZTB3417	.62 x 34 x 17
	150 3.40 .85
	1 \$204
	2 \$245
	3 \$293
	4 \$346
	5 \$398

For use on **Z36S23HN** hutch. Includes mounting screws.

ZTB2817	.62 x 28 x 17
	250 2.80 .85
	1 \$196
	2 \$236
	3 \$283
	4 \$335
	5 \$386

For use on **Z30S23HN** hutch. Includes mounting screws.

TACKBOARDS FOR HUTCHES - 36" / 36.5" HIGH

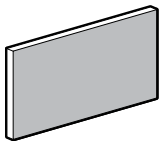

Tackboard

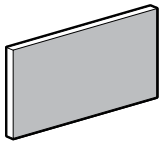

Tackboard

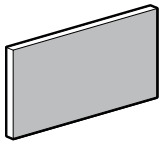

Tackboard

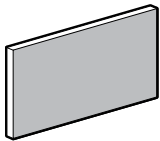

Tackboard

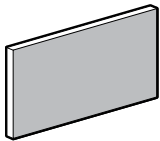

Tackboard

FABRIC GRADE LIST PRICE

ZTB8216	.62 x 82 x 15.75
	150 8.20 2
	1 \$516
	2 \$618
	3 \$741
	4 \$886
	5 \$1019

For use on **Z84S36H and Z84S36HN** hutches. Includes mounting screws.

ZTB7016	.62 x 70 x 15.75
	150 7 1.30
	1 \$343
	2 \$412
	3 \$495
	4 \$589
	5 \$678

For use on **Z72S36H and Z72S36HN** hutches. Includes mounting screws.

ZTB6916	.62 x 69.5 x 15.75
	150 7 1.30
	1 \$340
	2 \$408
	3 \$491
	4 \$584
	5 \$672

For use on **Z71S36H and Z71S36HN** hutches. Includes mounting screws.

ZTB6416	.62 x 64 x 15.75
	150 6.40 1.30
	1 \$337
	2 \$404
	3 \$483
	4 \$576
	5 \$663

For use on **Z66S36H and Z66S36HN** hutches. Includes mounting screws.

ZTB5816	.62 x 58 x 15.75
	150 5.80 1.08
	1 \$329
	2 \$394
	3 \$474
	4 \$564
	5 \$649

For use on **Z60S36H and Z60S36HN** hutches. Includes mounting screws.

Required Specifications

Fabric

TACKBOARDS FOR HUTCHES - 36" / 36.5" HIGH

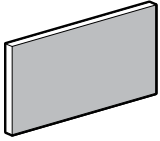

Tackboard

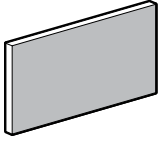

Tackboard

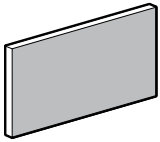

Tackboard

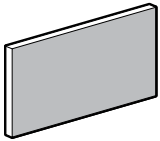

Tackboard

MODEL#	DIMENSIONS D x W x H	FREIGHT CLASS	WT/LBS.	CUBIC FT.	FABRIC GRADE	LIST PRICE
ZTB4616	.62 x 46 x 15.75	150	4.60	.85	1	\$219
					2	\$263
					3	\$315
					4	\$374
					5	\$431

For use on **Z48S36H and Z48S36HN** hutches. Includes mounting screws.

ZTB4016	.62 x 40 x 15.75	150	4	.85	1	\$212
					2	\$253
					3	\$304
					4	\$360
					5	\$414

For use on **Z42S36H and H42S36HN** hutch. Includes mounting screws.

ZTB3416	.62 x 34 x 15.75	150	3.40	.85	1	\$204
					2	\$245
					3	\$293
					4	\$346
					5	\$398

For use on **Z36S36H and H36S36HN** hutch. Includes mounting screws.

ZTB2816	.62 x 28 x 15.75	250	2.80	.85	1	\$196
					2	\$236
					3	\$283
					4	\$335
					5	\$386

For use on **Z30S36H and H30S36HN** hutch. Includes mounting screws.

TACKBOARDS FOR HUTCHES - 42.4", 42.9" AND 54.9", 55.4" HIGH

FABRIC GRADE LIST PRICE

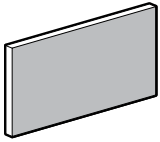

Tackboard

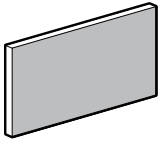

Tackboard

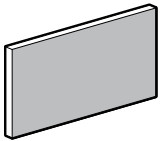

Tackboard

ZTB8221	.62 x 82 x 21	150	12.80	2.30	1	\$629
					2	\$753
					3	\$904
					4	\$1080
					5	\$1242

For use on **Z84S42H, Z84S42HN, Z84S55H and Z84S55HN** hutches. Includes mounting screws.

ZTB7021	.62 x 70 x 21	125	11	1.50	1	\$422
					2	\$503
					3	\$605
					4	\$721
					5	\$830

For use on **Z72S42H, Z72S42HN, Z72S55H and Z72S55HN** hutches. Includes mounting screws.

ZTB6921	.62 x 69 x 21	125	10.70	1.50	1	\$414
					2	\$498
					3	\$597
					4	\$712
					5	\$819

For use on **Z71S42H, Z71S42HN, Z71S55H and Z71S55HN** hutches. Includes mounting screws.

Required Specifications

Fabric

TACKBOARDS - 42.4", 42.9" & 54.9", 55.4" HIGH

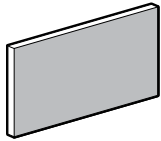

Tackboard

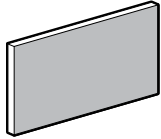

Tackboard

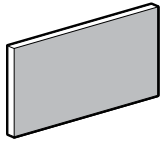

Tackboard

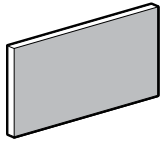

Tackboard

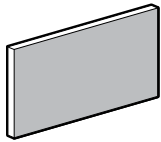

Tackboard

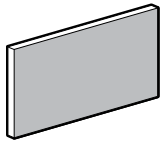

Tackboard

MODEL# DIMENSIONS FREIGHT CLASS WT/LBS. CUBIC FT. FABRIC GRADE LIST PRICE

	D x W x H					
ZTB6421	.62 x 64 x 21	125	10	1.50	1	\$391
					2	\$470
					3	\$564
					4	\$672
					5	\$773

For use on **Z66S42H, Z66S42HN, Z66S55H and Z66S55HN** hutches. Includes mounting screws.

ZTB5821	.62 x 58 x 21	125	9	1.50	1	\$387
					2	\$467
					3	\$559
					4	\$665
					5	\$765

For use on **Z60S42H, Z60S42HN, Z60S55H and Z60S55HN** hutches. Includes mounting screws.

ZTB4621	.62 x 46 x 21	125	7.20	1	1	\$239
					2	\$288
					3	\$343
					4	\$408
					5	\$470

For use on **Z48S42H, Z48S42HN, Z48S55H and Z48S55HN** hutches. Includes mounting screws.

ZTB4021	.62 x 40 x 21	125	6.20	1	1	\$231
					2	\$277
					3	\$334
					4	\$396
					5	\$456

For use on **Z42S42H, Z42S42HN, Z42S55H and Z42S55HN** hutches. Includes mounting screws.

ZTB3421	.62 x 34 x 21	150	5.30	1	1	\$228
					2	\$273
					3	\$328
					4	\$388
					5	\$447

For use on **Z36S42H, Z36S42HN, Z36S55H and Z36S55HN** hutches. Includes mounting screws.

ZTB2821	.62 x 28 x 21	150	4.50	1	1	\$225
					2	\$269
					3	\$322
					4	\$383
					5	\$441

For use on **Z30S42H, Z30S42HN, Z30S55H and Z30S55HN** hutches. Includes mounting screws.

Required Specifications

Fabric

14" WALL MOUNTED TACKBOARDS

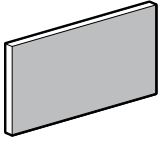

Wall Mounted Tackboard

MODEL#	DIMENSIONS D x W x H	FREIGHT CLASS	WT/LBS.	CUBIC FT.	FABRIC GRADE	LIST PRICE
ZWHT3014	1.25 x 30 x 13.5-14	150	4.70	1	1	\$220
					2	\$253
					3	\$291
					4	\$335
					5	\$385

For use under **Z30S200S/OSN** for a finished height of **65"/65.5"**. Standard with pre-mounted "J" bracket for wall mount applications.

• **NOTE:** Care should be taken to mount the units. Units should be mounted to wall studs using correct fasteners. Failure to do so may result in collapse of the unit and subsequent personal injury. **Mounting hardware not included.** Mounting hardware used should be based on wall material. Consult an installation professional for proper wall mounting.

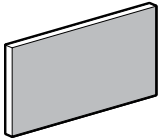

Wall Mounted Tackboard

ZWHT3614	1.25 x 36 x 13.5-14	150	5.60	1	1	\$244
					2	\$281
					3	\$323
					4	\$371
					5	\$427

For use under **Z36S200S/OSN** for a finished height of **65"/65.5"**. Standard with pre-mounted "J" bracket for wall mount applications.

• **NOTE:** Care should be taken to mount the units. Units should be mounted to wall studs using correct fasteners. Failure to do so may result in collapse of the unit and subsequent personal injury. **Mounting hardware not included.** Mounting hardware used should be based on wall material. Consult an installation professional for proper wall mounting.

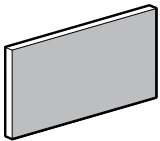

Wall Mounted Tackboard

ZWHT4214	1.25 x 42 x 13.5-14	125	6.50	1	1	\$285
					2	\$327
					3	\$376
					4	\$432
					5	\$497

For use under **Z42S200S/OSN** for a finished height of **65"/65.5"**. Standard with pre-mounted "J" bracket for wall mount applications.

• **NOTE:** Care should be taken to mount the units. Units should be mounted to wall studs using correct fasteners. Failure to do so may result in collapse of the unit and subsequent personal injury. **Mounting hardware not included.** Mounting hardware used should be based on wall material. Consult an installation professional for proper wall mounting.

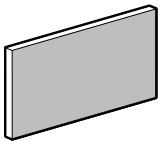

Wall Mounted Tackboard

ZWHT4814	1.25 x 48 x 13.5-14	125	7.50	1	1	\$309
					2	\$355
					3	\$408
					4	\$469
					5	\$539

For use under **Z48S200S/OSN** for a finished height of **65"/65.5"**. Standard with pre-mounted "J" bracket for wall mount applications.

• **NOTE:** Care should be taken to mount the units. Units should be mounted to wall studs using correct fasteners. Failure to do so may result in collapse of the unit and subsequent personal injury. **Mounting hardware not included.** Mounting hardware used should be based on wall material. Consult an installation professional for proper wall mounting.

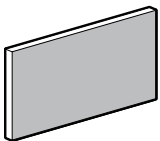

Wall Mounted Tackboard

ZWHT6014	1.25 x 60 x 13.5-14	150	9.30	1.80	1	\$385
					2	\$442
					3	\$509
					4	\$585
					5	\$672

For use under **Z60S200S/OSN** for a finished height of **65"/65.5"**. Standard with pre-mounted "J" bracket for wall mount applications.

• **NOTE:** Care should be taken to mount the units. Units should be mounted to wall studs using correct fasteners. Failure to do so may result in collapse of the unit and subsequent personal injury. **Mounting hardware not included.** Mounting hardware used should be based on wall material. Consult an installation professional for proper wall mounting.

Required Specifications

Fabric

14" WALL MOUNTED TACKBOARDS

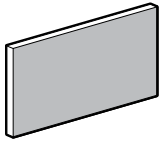

Wall Mounted Tackboard

MODEL#	DIMENSIONS	FREIGHT CLASS	WT/LBS.	CUBIC FT.	FABRIC GRADE	LIST PRICE
ZWHT6614	1.25 x 66 x 13.5-14	150	10.30	1.80		
					D x W x H	
					1	\$409
					2	\$470
					3	\$540
4	\$621					
					5	\$714

For use under **ZxxS200S/OSN** for a finished height of **65"/65.5"**. Standard with pre-mounted "J" bracket for wall mount applications.

• **NOTE:** Care should be taken to mount the units. Units should be mounted to wall studs using correct fasteners. Failure to do so may result in collapse of the unit and subsequent personal injury. **Mounting hardware not included.** Mounting hardware used should be based on wall material. Consult an installation professional for proper wall mounting.

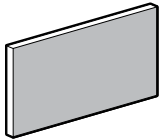

Wall Mounted Tackboard

ZWHT7214	1.25 x 72 x 13.5-14	125	11.20	1.80		
					1	\$449
					2	\$516
					3	\$594
					4	\$683
					5	\$785

For use under **ZxxS200S/OSN** for a finished height of **65"/65.5"**. Standard with pre-mounted "J" bracket for wall mount applications.

• **NOTE:** Care should be taken to mount the units. Units should be mounted to wall studs using correct fasteners. Failure to do so may result in collapse of the unit and subsequent personal injury. **Mounting hardware not included.** Mounting hardware used should be based on wall material. Consult an installation professional for proper wall mounting.

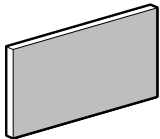

Wall Mounted Tackboard

ZWHT7814	1.25 x 78 x 13.5-14	125	12.10	1.80		
					1	\$473
					2	\$544
					3	\$626
					4	\$719
					5	\$827

For use under **ZxxS200S/OSN** for a finished height of **65"/65.5"**. Standard with pre-mounted "J" bracket for wall mount applications.

• **NOTE:** Care should be taken to mount the units. Units should be mounted to wall studs using correct fasteners. Failure to do so may result in collapse of the unit and subsequent personal injury. **Mounting hardware not included.** Mounting hardware used should be based on wall material. Consult an installation professional for proper wall mounting.

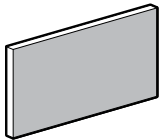

Wall Mounted Tackboard

ZWHT8414	1.25 x 84 x 13.5-14	125	13.10	1.80		
					1	\$513
					2	\$591
					3	\$679
					4	\$781
					5	\$897

For use under **ZxxS200S/OSN** for a finished height of **65"/65.5"**. Standard with pre-mounted "J" bracket for wall mount applications.

• **NOTE:** Care should be taken to mount the units. Units should be mounted to wall studs using correct fasteners. Failure to do so may result in collapse of the unit and subsequent personal injury. **Mounting hardware not included.** Mounting hardware used should be based on wall material. Consult an installation professional for proper wall mounting.

18" WALL MOUNTED TACKBOARDS

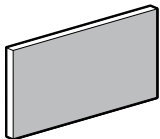

Wall Mounted Tackboard

ZWHT3018	1.25 x 30 x 17.5-18	125	6	1		
					1	\$228
					2	\$262
					3	\$302
					4	\$347
					5	\$399

For use under **Z30S160S/OSN** for a finished height of **65"/65.5"**. Standard with pre-mounted "J" bracket for wall mount applications.

• **NOTE:** Care should be taken to mount the units. Units should be mounted to wall studs using correct fasteners. Failure to do so may result in collapse of the unit and subsequent personal injury. **Mounting hardware not included.** Mounting hardware used should be based on wall material. Consult an installation professional for proper wall mounting.

Required Specifications

Fabric

18" WALL MOUNTED TACKBOARDS

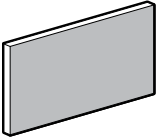

Wall Mounted Tackboard

MODEL#	DIMENSIONS D x W x H	FREIGHT CLASS	WT/LBS.	CUBIC FT.	FABRIC GRADE	LIST PRICE
ZWHT3618	1.25 x 36 x 17.5-18	125	7.20	1	1	\$219
					2	\$252
					3	\$290
					4	\$334
					5	\$384

For use under **Z36S160S/OSN** for a finished height of **65"/65.5"**. Standard with pre-mounted "J" bracket for wall mount applications.

- **NOTE:** Care should be taken to mount the units. Units should be mounted to wall studs using correct fasteners. Failure to do so may result in collapse of the unit and subsequent personal injury. **Mounting hardware not included.** Mounting hardware used should be based on wall material. Consult an installation professional for proper wall mounting.

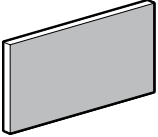

Wall Mounted Tackboard

ZWHT4218	1.25 x 42 x 17.5-18	100	8.40	1	1	\$255
					2	\$294
					3	\$338
					4	\$388
					5	\$446

For use under **Z42S160S/OSN** for a finished height of **65"/65.5"**. Standard with pre-mounted "J" bracket for wall mount applications.

- **NOTE:** Care should be taken to mount the units. Units should be mounted to wall studs using correct fasteners. Failure to do so may result in collapse of the unit and subsequent personal injury. **Mounting hardware not included.** Mounting hardware used should be based on wall material. Consult an installation professional for proper wall mounting.

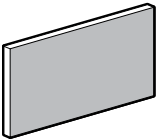

Wall Mounted Tackboard

ZWHT4818	1.25 x 48 x 17.5-18	100	9.60	1	1	\$277
					2	\$319
					3	\$367
					4	\$422
					5	\$485

For use under **Z48S160S/OSN** for a finished height of **65"/65.5"**. Standard with pre-mounted "J" bracket for wall mount applications.

- **NOTE:** Care should be taken to mount the units. Units should be mounted to wall studs using correct fasteners. Failure to do so may result in collapse of the unit and subsequent personal injury. **Mounting hardware not included.** Mounting hardware used should be based on wall material. Consult an installation professional for proper wall mounting.

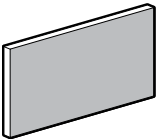

Wall Mounted Tackboard

ZWHT6018	1.25 x 60 x 17.5-18	125	12	1.80	1	\$343
					2	\$395
					3	\$454
					4	\$522
					5	\$600

For use under **Z60S160S/OSN** for a finished height of **65"/65.5"**. Standard with pre-mounted "J" bracket for wall mount applications.

- **NOTE:** Care should be taken to mount the units. Units should be mounted to wall studs using correct fasteners. Failure to do so may result in collapse of the unit and subsequent personal injury. **Mounting hardware not included.** Mounting hardware used should be based on wall material. Consult an installation professional for proper wall mounting.

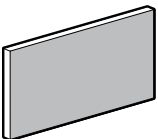

Wall Mounted Tackboard

ZWHT6618	1.25 x 66 x 17.5-18	125	13.20	1.80	1	\$365
					2	\$420
					3	\$483
					4	\$556
					5	\$639

For use under **ZxxS160S/OSN** for a finished height of **65"/65.5"**. Standard with pre-mounted "J" bracket for wall mount applications.

- **NOTE:** Care should be taken to mount the units. Units should be mounted to wall studs using correct fasteners. Failure to do so may result in collapse of the unit and subsequent personal injury. **Mounting hardware not included.** Mounting hardware used should be based on wall material. Consult an installation professional for proper wall mounting.

Required Specifications

Fabric

18" WALL MOUNTED TACKBOARDS

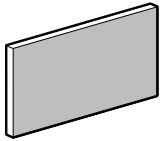

Wall Mounted Tackboard

MODEL#	DIMENSIONS	FREIGHT CLASS	WT/LBS.	CUBIC FT.	FABRIC GRADE	LIST PRICE
ZWHT7218	1.25 x 72 x 17.5-18	100	14.40	1.80	D x W x H	
					1	\$401
					2	\$462
					3	\$531
					4	\$610
5	\$702					

For use under **ZxxS160S/OSN** for a finished height of **65"/65.5"**. Standard with pre-mounted "J" bracket for wall mount applications.

• **NOTE:** Care should be taken to mount the units. Units should be mounted to wall studs using correct fasteners. Failure to do so may result in collapse of the unit and subsequent personal injury. **Mounting hardware not included.** Mounting hardware used should be based on wall material. Consult an installation professional for proper wall mounting.

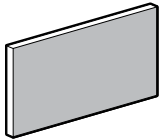

Wall Mounted Tackboard

ZWHT7818	1.25 x 78 x 17.5-18	100	15.60	1.80	1	\$422
					2	\$486
					3	\$559
					4	\$642
					5	\$739

For use under **ZxxS160S/OSN** for a finished height of **65"/65.5"**. Standard with pre-mounted "J" bracket for wall mount applications.

• **NOTE:** Care should be taken to mount the units. Units should be mounted to wall studs using correct fasteners. Failure to do so may result in collapse of the unit and subsequent personal injury. **Mounting hardware not included.** Mounting hardware used should be based on wall material. Consult an installation professional for proper wall mounting.

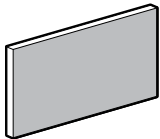

Wall Mounted Tackboard

ZWHT8418	1.25 x 84 x 17.5-18	100	16.80	1.80	1	\$458
					2	\$527
					3	\$606
					4	\$697
					5	\$802

For use under **ZxxS160S/OSN** for a finished height of **65"/65.5"**. Standard with pre-mounted "J" bracket for wall mount applications.

• **NOTE:** Care should be taken to mount the units. Units should be mounted to wall studs using correct fasteners. Failure to do so may result in collapse of the unit and subsequent personal injury. **Mounting hardware not included.** Mounting hardware used should be based on wall material. Consult an installation professional for proper wall mounting.

21" WALL MOUNTED TACKBOARDS

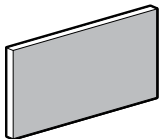

Wall Mounted Tackboard

ZWHT3021	1.25 x 30 x 20.5-21	125	7	1	1	\$202
					2	\$233
					3	\$268
					4	\$308
					5	\$354

For use under **Z30S210S/OSN** or **Z30S330S/OSN** for a finished height of **71.5"/72"**. Standard with pre-mounted "J" bracket for wall mount applications. For use under **Z30S330S/OSN** for a finished height of **84"/84.5"**

• **NOTE:** Care should be taken to mount the units. Units should be mounted to wall studs using correct fasteners. Failure to do so may result in collapse of the unit and subsequent personal injury. **Mounting hardware not included.** Mounting hardware used should be based on wall material. Consult an installation professional for proper wall mounting.

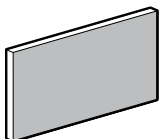

Wall Mounted Tackboard

ZWHT3621	1.25 x 36 x 20.5-21	100	8.40	1	1	\$224
					2	\$258
					3	\$297
					4	\$341
					5	\$392

For use under **Z36S210S/OSN** or **Z36S330S/OSN** for a finished height of **71.5"/72"**. Standard with pre-mounted "J" bracket for wall mount applications. For use under **Z30S330S/OSN** for a finished height of **84"/84.5"**

• **NOTE:** Care should be taken to mount the units. Units should be mounted to wall studs using correct fasteners. Failure to do so may result in collapse of the unit and subsequent personal injury. **Mounting hardware not included.** Mounting hardware used should be based on wall material. Consult an installation professional for proper wall mounting.

Required Specifications

Fabric

21" WALL MOUNTED TACKBOARDS

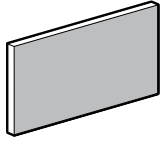

Wall Mounted Tackboard

MODEL#	DIMENSIONS D x W x H	FREIGHT CLASS	WT/LBS.	CUBIC FT.	FABRIC GRADE	LIST PRICE
ZWHT4221	1.25 x 42 x 20.5-21	100	9.80	1	1	\$260
					2	\$299
					3	\$344
					4	\$396
					5	\$455

For use under **Z42S210S/OSN** or **Z42S330S/OSN** for a finished height of **71.5"/72"**. Standard with pre-mounted "J" bracket for wall mount applications. For use under **Z30S330S/OSN** for a finished height of **84"/84.5"**

• **NOTE:** Care should be taken to mount the units. Units should be mounted to wall studs using correct fasteners. Failure to do so may result in collapse of the unit and subsequent personal injury. **Mounting hardware not included.** Mounting hardware used should be based on wall material. Consult an installation professional for proper wall mounting.

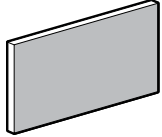

Wall Mounted Tackboard

ZWHT4821	1.25 x 48 x 20.5-21	92.5	11.20	1	1	\$282
					2	\$325
					3	\$374
					4	\$429
					5	\$494

For use under **Z48S210S/OSN** or **Z48S330S/OSN** for a finished height of **71.5"/72"**. Standard with pre-mounted "J" bracket for wall mount applications. For use under **Z30S330S/OSN** for a finished height of **84"/84.5"**

• **NOTE:** Care should be taken to mount the units. Units should be mounted to wall studs using correct fasteners. Failure to do so may result in collapse of the unit and subsequent personal injury. **Mounting hardware not included.** Mounting hardware used should be based on wall material. Consult an installation professional for proper wall mounting.

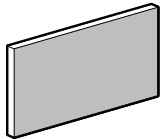

Wall Mounted Tackboard

ZWHT6021	1.25 x 60 x 20.5-21	125	14	1.80	1	\$350
					2	\$403
					3	\$463
					4	\$533
					5	\$613

For use under **Z60S210S/OSN** or **Z60S330S/OSN** for a finished height of **71.5"/72"**. Standard with pre-mounted "J" bracket for wall mount applications. For use under **Z30S330S/OSN** for a finished height of **84"/84.5"**

• **NOTE:** Care should be taken to mount the units. Units should be mounted to wall studs using correct fasteners. Failure to do so may result in collapse of the unit and subsequent personal injury. **Mounting hardware not included.** Mounting hardware used should be based on wall material. Consult an installation professional for proper wall mounting.

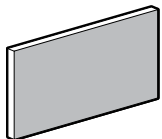

Wall Mounted Tackboard

ZWHT6621	1.25 x 66 x 20.5-21	100	15.40	1.80	1	\$372
					2	\$428
					3	\$493
					4	\$566
					5	\$651

For use under **ZxxS210S/OSN** or **ZxxS330S/OSN** for a finished height of **71.5"/72"**. Standard with pre-mounted "J" bracket for wall mount applications. For use under **Z30S330S/OSN** for a finished height of **84"/84.5"**

• **NOTE:** Care should be taken to mount the units. Units should be mounted to wall studs using correct fasteners. Failure to do so may result in collapse of the unit and subsequent personal injury. **Mounting hardware not included.** Mounting hardware used should be based on wall material. Consult an installation professional for proper wall mounting.

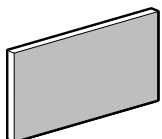

Wall Mounted Tackboard

ZWHT7221	1.25 x 72 x 20.5-21	100	16.80	1.80	1	\$408
					2	\$470
					3	\$540
					4	\$621
					5	\$714

For use under **ZxxS210S/OSN** or **ZxxS330S/OSN** for a finished height of **71.5"/72"**. Standard with pre-mounted "J" bracket for wall mount applications. For use under **Z30S330S/OSN** for a finished height of **84"/84.5"**

• **NOTE:** Care should be taken to mount the units. Units should be mounted to wall studs using correct fasteners. Failure to do so may result in collapse of the unit and subsequent personal injury. **Mounting hardware not included.** Mounting hardware used should be based on wall material. Consult an installation professional for proper wall mounting.

Required Specifications
Fabric

21" WALL MOUNTED TACKBOARDS

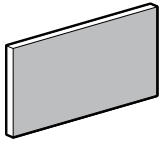

Wall Mounted Tackboard

MODEL#	DIMENSIONS D x W x H	FREIGHT CLASS	WT/LBS.	CUBIC FT.	FABRIC GRADE	LIST PRICE
ZWHT7821	1.25 x 78 x 20.5-21	92.5	18.20	1.80	1	\$430
					2	\$495
					3	\$569
					4	\$655
					5	\$753

For use under **ZxxS210S/OSN** or **ZxxS330S/OSN** for a finished height of **71.5"/72"**. Standard with pre-mounted "J" bracket for wall mount applications. For use under **Z30S330S/OSN** for a finished height of **84"/84.5"**

• **NOTE:** Care should be taken to mount the units. Units should be mounted to wall studs using correct fasteners. Failure to do so may result in collapse of the unit and subsequent personal injury. **Mounting hardware not included.** Mounting hardware used should be based on wall material. Consult an installation professional for proper wall mounting.

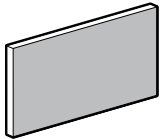

Wall Mounted Tackboard

ZWHT8421	1.25 x 84 x 20.5-21	92.5	19.60	1.80	1	\$467
					2	\$538
					3	\$618
					4	\$711
					5	\$817

For use under **ZxxS210S/OSN** or **ZxxS330S/OSN** for a finished height of **71.5"/72"**. Standard with pre-mounted "J" bracket for wall mount applications. For use under **Z30S330S/OSN** for a finished height of **84"/84.5"**

• **NOTE:** Care should be taken to mount the units. Units should be mounted to wall studs using correct fasteners. Failure to do so may result in collapse of the unit and subsequent personal injury. **Mounting hardware not included.** Mounting hardware used should be based on wall material. Consult an installation professional for proper wall mounting.

25" WALL MOUNTED TACKBOARDS

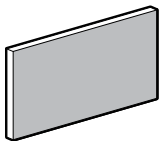

Wall Mounted Tackboard

ZWHT3025	1.25 x 30 x 24.5-25	100	8.30	1	1	\$208
					2	\$240
					3	\$276
					4	\$317
					5	\$364

For use under **Z30S160S/OSN** for a finished height of **71.5"/72"**. Standard with pre-mounted "J" bracket for wall mount applications.

• **NOTE:** Care should be taken to mount the units. Units should be mounted to wall studs using correct fasteners. Failure to do so may result in collapse of the unit and subsequent personal injury. **Mounting hardware not included.** Mounting hardware used should be based on wall material. Consult an installation professional for proper wall mounting.

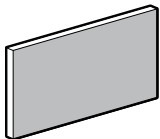

Wall Mounted Tackboard

ZWHT3625	1.25 x 36 x 24.5-25	92.5	10	1	1	\$231
					2	\$266
					3	\$306
					4	\$352
					5	\$405

For use under **Z36S160S/OSN** for a finished height of **71.5"/72"**. Standard with pre-mounted "J" bracket for wall mount applications.

• **NOTE:** Care should be taken to mount the units. Units should be mounted to wall studs using correct fasteners. Failure to do so may result in collapse of the unit and subsequent personal injury. **Mounting hardware not included.** Mounting hardware used should be based on wall material. Consult an installation professional for proper wall mounting.

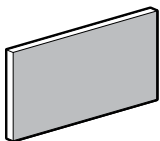

Wall Mounted Tackboard

ZWHT4225	1.25 x 42 x 24.5-25	92.5	11.70	1	1	\$268
					2	\$309
					3	\$355
					4	\$408
					5	\$469

For use under **Z42S160S/OSN** for a finished height of **71.5"/72"**. Standard with pre-mounted "J" bracket for wall mount applications.

• **NOTE:** Care should be taken to mount the units. Units should be mounted to wall studs using correct fasteners. Failure to do so may result in collapse of the unit and subsequent personal injury. **Mounting hardware not included.** Mounting hardware used should be based on wall material. Consult an installation professional for proper wall mounting.

Required Specifications

Fabric

25" WALL MOUNTED TACKBOARDS

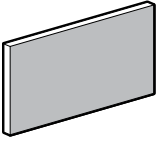

Wall Mounted Tackboard

MODEL#	DIMENSIONS D x W x H	FREIGHT CLASS	WT/LBS.	CUBIC FT.	FABRIC GRADE	LIST PRICE
ZWHT4825	1.25 x 48 x 24.5-25	85	13.30	1	1	\$291
					2	\$335
					3	\$385
					4	\$443
					5	\$509

For use under **Z48S160S/OSN** for a finished height of **71.5"/72"**. Standard with pre-mounted "J" bracket for wall mount applications.

• **NOTE:** Care should be taken to mount the units. Units should be mounted to wall studs using correct fasteners. Failure to do so may result in collapse of the unit and subsequent personal injury. **Mounting hardware not included.** Mounting hardware used should be based on wall material. Consult an installation professional for proper wall mounting.

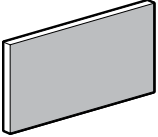

Wall Mounted Tackboard

ZWHT6025	1.25 x 60 x 24.5-25	100	16.70	1.80	1	\$360
					2	\$415
					3	\$477
					4	\$548
					5	\$630

For use under **Z60S160S/OSN** for a finished height of **71.5"/72"**. Standard with pre-mounted "J" bracket for wall mount applications.

• **NOTE:** Care should be taken to mount the units. Units should be mounted to wall studs using correct fasteners. Failure to do so may result in collapse of the unit and subsequent personal injury. **Mounting hardware not included.** Mounting hardware used should be based on wall material. Consult an installation professional for proper wall mounting.

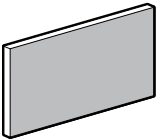

Wall Mounted Tackboard

ZWHT6625	1.25 x 66 x 24.5-25	92.5	18.30	1.80	1	\$383
					2	\$441
					3	\$507
					4	\$583
					5	\$670

For use under **ZxxS160S/OSN** for a finished height of **71.5"/72"**. Standard with pre-mounted "J" bracket for wall mount applications.

• **NOTE:** Care should be taken to mount the units. Units should be mounted to wall studs using correct fasteners. Failure to do so may result in collapse of the unit and subsequent personal injury. **Mounting hardware not included.** Mounting hardware used should be based on wall material. Consult an installation professional for proper wall mounting.

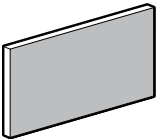

Wall Mounted Tackboard

ZWHT7225	1.25 x 72 x 24.5-25	92.5	20	1.80	1	\$420
					2	\$484
					3	\$556
					4	\$639
					5	\$735

For use under **ZxxS160S/OSN** for a finished height of **71.5"/72"**. Standard with pre-mounted "J" bracket for wall mount applications.

• **NOTE:** Care should be taken to mount the units. Units should be mounted to wall studs using correct fasteners. Failure to do so may result in collapse of the unit and subsequent personal injury. **Mounting hardware not included.** Mounting hardware used should be based on wall material. Consult an installation professional for proper wall mounting.

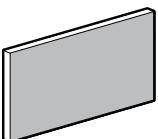

Wall Mounted Tackboard

ZWHT7825	1.25 x 78 x 24.5-25	85	21.70	1.80	1	\$443
					2	\$510
					3	\$587
					4	\$674
					5	\$775

For use under **ZxxS160S/OSN** for a finished height of **71.5"/72"**. Standard with pre-mounted "J" bracket for wall mount applications.

• **NOTE:** Care should be taken to mount the units. Units should be mounted to wall studs using correct fasteners. Failure to do so may result in collapse of the unit and subsequent personal injury. **Mounting hardware not included.** Mounting hardware used should be based on wall material. Consult an installation professional for proper wall mounting.

Required Specifications
Fabric

25" WALL MOUNTED TACKBOARDS

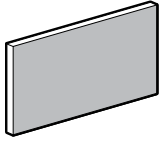

Wall Mounted Tackboard

MODEL# DIMENSIONS FREIGHT CLASS WT/LBS. CUBIC FT. FABRIC GRADE LIST PRICE

	D x W x H					
ZWHT8425	1.25 x 84 x 24.5-25	85	23.30	1.80	1	\$480
					2	\$553
					3	\$636
					4	\$731
					5	\$840

For use under **ZxxS160S/OSN** for a finished height of **71.5"/72"**. Standard with pre-mounted "J" bracket for wall mount applications.

- **NOTE:** Care should be taken to mount the units. Units should be mounted to wall studs using correct fasteners. Failure to do so may result in collapse of the unit and subsequent personal injury. **Mounting hardware not included.** Mounting hardware used should be based on wall material. Consult an installation professional for proper wall mounting.

Required Specifications

Fabric

BOOKCASES

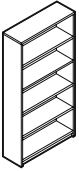

Bookcase - 72"/72.5" High

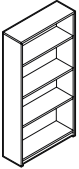

Bookcase - 65"/65.5" High

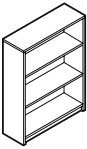

Bookcase - 48"/48.5" High

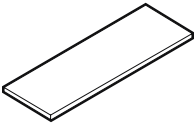

Bookcase Shelf

MODEL#	DIMENSIONS	FREIGHT CLASS	WT./LBS.	CUBIC FT.	1"TOP	1.5" TOP	GLAZE ADD	HP ADD
--------	------------	---------------	----------	-----------	-------	----------	-----------	--------

D x W x H

ZHBC72	12 x 36 x 72-72.5	125	176	23	\$812	\$857	N/A	N/A
--------	-------------------	-----	-----	----	--------------	--------------	-----	-----

One fixed shelf.

ZHBC65	12 x 36 x 65-65.5	125	156	21	\$787	\$831	N/A	N/A
--------	-------------------	-----	-----	----	--------------	--------------	-----	-----

One fixed shelf and two adjustable shelves.

ZHBC48	12 x 36 x 48-48.5	125	122	15.75	\$596	\$640	N/A	N/A
--------	-------------------	-----	-----	-------	--------------	--------------	-----	-----

Two adjustable shelves.

ZHSHELF	11 x 34	100	13	1.50	\$206	N/A	N/A	N/A
---------	---------	-----	----	------	--------------	-----	-----	-----

Extra shelf for bookcases. 1" thick.

TABLE TOP BOOKCASES

NOTE: UNITS UNDER 30"W MUST BE SECURELY FASTENED TO THE WALL OR GANGED TO AN ADJACENT UNIT 30"W OR WIDER

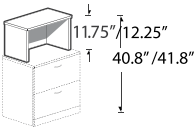

Table Top Bookcase 11.75"/12.25" High

Z36S12TN	16 x 36 x 11.75-12.25	100	44.91	5.25	\$236	\$281	N/A	N/A
----------	-----------------------	-----	-------	------	--------------	--------------	-----	-----

Z30S12TN	16 x 30 x 11.75-12.25	100	39.33	4.30	\$216	\$254	N/A	N/A
----------	-----------------------	-----	-------	------	--------------	--------------	-----	-----

To be placed **on top of 29"/29.5" high units to achieve 40.8"/41.8" final height** or placed on top of **40.8"/41.3" high units to achieve 52.5"/53.5" final height.**

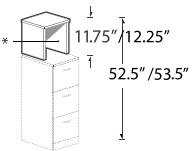

Table Top Bookcase 11.75"/12.25" High

Z21S12TN	16 x 21 x 11.75-12.25	100	28.87	3.10	\$180	\$211	N/A	N/A
----------	-----------------------	-----	-------	------	--------------	--------------	-----	-----

Z18S12TN	16 x 18 x 11.75-12.25	92.5	27.13	2.70	\$172	\$199	N/A	N/A
----------	-----------------------	------	-------	------	--------------	--------------	-----	-----

Z16S12TN	16 x 16 x 11.75-12.25	92.5	24.57	2.40	\$164	\$190	N/A	N/A
----------	-----------------------	------	-------	------	--------------	--------------	-----	-----

Z15S12TN	16 x 15 x 11.75-12.25	92.5	24.34	2.30	\$158	\$179	N/A	N/A
----------	-----------------------	------	-------	------	--------------	--------------	-----	-----

Z12S12TN	16 x 12 x 11.75-12.25	92.5	21.55	1.90	\$149	\$166	N/A	N/A
----------	-----------------------	------	-------	------	--------------	--------------	-----	-----

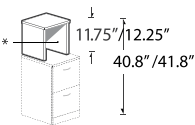

Table Top Bookcase 11.75"/12.25" High

To be placed **on top of 29"/29.5" high units to achieve 40.8"/41.8" final height** or placed on top of **40.8"/41.3" high units to achieve 52.5"/53.5" final height.**

Required Specifications

Finishes
Top/Edge Detail

Optional Specifications

Collator (Open Shelf)

TABLE TOP BOOKCASES

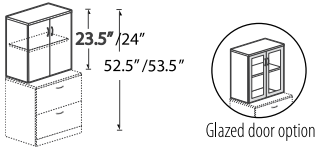

Table Top Bookcase 23.5"/24" High

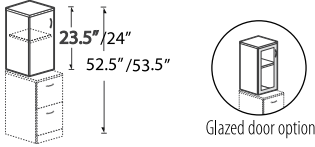

Table Top Bookcase with Door - LEFT 23.5"/24" High

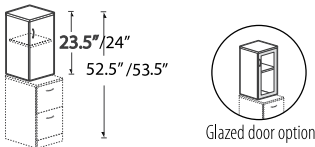

Table Top Bookcase with Door - RIGHT 23.5"/24" High

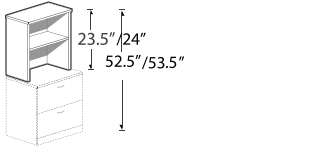

Table Top Bookcase 23.5"/24" High

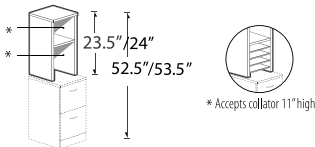

Table Top Bookcase 23.5"/24" High

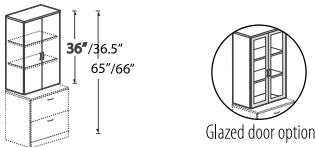

Table Top Bookcase with Doors 36"/36.5" High

MODEL#	DIMENSIONS	FREIGHT CLASS	WT./LBS.	CUBIC FT.	1" TOP	1.5" TOP	GLAZE ADD	HP ADD	
D x W x H									
Z36S23T	16 x 36 x 23-23.5	100	87.45	9.50	\$567	\$612	\$560	N/A	
Z30S23T	16 x 30 x 23-23.5	100	75.78	8	\$517	\$555	\$494	N/A	

Designed to be placed **on top of 29"/29.5" high units to achieve 52.5"/53.5" final height.** DO NOT USE ON TOP OF 40.8"/41.3" HIGH UNITS. Laminate doors are standard. **Includes one adjustable shelf.** Standard with lock.

Z21S23TL	16 x 21 x 23-23.5	92.5	58.83	5.75	\$404	\$434	\$304	N/A
Z18S23TL	16 x 18 x 23-23.5	92.5	54.65	5	\$390	\$416	\$277	N/A
Z16S23TL	16 x 16 x 23-23.5	92.5	46.71	4.50	\$345	\$371	\$271	N/A
Z15S23TL	16 x 15 x 23-23.5	92.5	46.06	4.20	\$327	\$348	\$244	N/A
Z12S23TL	16 x 12 x 23-23.5	92.5	40.77	3.50	\$305	\$322	\$221	N/A

Designed to be placed **on top of 29"/29.5" high units to achieve 52.5"/53.5" final height.** DO NOT USE ON TOP OF 40.8"/41.3" HIGH UNITS. Laminate door is standard. **Includes one adjustable shelf.** Standard with lock.

Z21S23TR	16 x 21 x 23-23.5	92.5	58.83	5.75	\$404	\$434	\$304	N/A
Z18S23TR	16 x 18 x 23-23.5	92.5	54.65	5	\$390	\$416	\$277	N/A
Z16S23TR	16 x 16 x 23-23.5	92.5	46.71	4.50	\$345	\$371	\$271	N/A
Z15S23TR	16 x 15 x 23-23.5	92.5	46.06	4.20	\$327	\$348	\$244	N/A
Z12S23TR	16 x 12 x 23-23.5	92.5	40.77	3.50	\$305	\$322	\$221	N/A

Designed to be placed **on top of 29"/29.5" high units to achieve 52.5"/53.5" final height.** DO NOT USE ON TOP OF 40.8"/41.3" HIGH UNITS. Laminate door is standard. **Includes one adjustable shelf.** Standard with lock.

Z36S23TN	16 x 36 x 23-23.5	125	69.06	9.50	\$371	\$416	N/A	N/A
Z30S23TN	16 x 30 x 23-23.5	125	60.33	8	\$340	\$377	N/A	N/A

Designed to be placed **on top of 29"/29.5" high units to achieve 52.5"/53.5" final height.** DO NOT USE ON TOP OF 40.8"/41.3" HIGH UNITS. **Includes one adjustable shelf.**

Z21S23TN	16 x 21 x 23-23.5	100	47.77	5.75	\$290	\$320	N/A	N/A
Z18S23TN	16 x 18 x 23-23.5	100	44.98	5	\$285	\$311	N/A	N/A
Z16S23TN	16 x 16 x 23-23.5	100	38.22	4.50	\$240	\$266	N/A	N/A
Z15S23TN	16 x 15 x 23-23.5	100	37	4.20	\$231	\$251	N/A	N/A
Z12S23TN	16 x 12 x 23-23.5	100	34.15	3.50	\$215	\$233	N/A	N/A

Designed to be placed **on top of 29"/29.5" high units to achieve 52.5"/53.5" final height.** DO NOT USE ON TOP OF 40.8"/41.3" HIGH UNITS. **Includes one adjustable shelf.**

Z36S36T	16 x 36 x 35.5-36	100	124.30	14.25	\$731	\$776	\$722	N/A
Z30S36T	16 x 30 x 35.5-36	100	106.67	12	\$633	\$670	\$632	N/A

Designed to be placed **on top of 29"/29.5" high units to achieve 65"/66" final height.** Laminate doors are standard. **Includes two adjustable shelves.** Standard with lock.

Required Specifications

Finishes
Top/Edge Detail

Optional Specifications

Collator (Open Shelves)
Glazing - Doors

TABLE TOP BOOKCASES

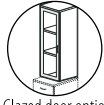
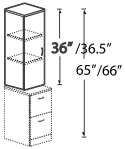

Glazed door option

**Table Top Bookcase with Doors
36"/36.5" High - LEFT**

MODEL#	DIMENSIONS D x W x H	FREIGHT CLASS	WT./LBS.	CUBIC FT.	1" TOP	1.5" TOP	GLAZE ADD	HP ADD
Z21S36TL	16 x 21 x 35.5-36	100	82.99	8.75	\$517	\$548	\$395	N/A
Z18S36TL	16 x 18 x 35.5-36	100	74.72	7.50	\$495	\$521	\$357	N/A
Z16S36TL	16 x 16 x 35.5-36	92.5	67.82	6.75	\$452	\$478	\$352	N/A
Z15S36TL	16 x 15 x 35.5-36	92.5	66.46	6.50	\$429	\$450	\$312	N/A
Z12S36TL	16 x 12 x 35.5-36	92.5	59.30	5.25	\$399	\$416	\$282	N/A

Designed to be placed **on top of 29"/29.5" high units to achieve 65"/66" final height.** Laminate door is standard.
Includes two adjustable shelves. Standard with lock.

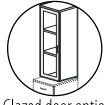
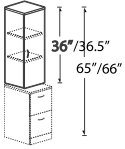

Glazed door option

**Table Top Bookcase with Doors
36"/36.5" High - RIGHT**

Z21S36TR	16 x 21 x 35.5-36	100	82.99	8.75	\$517	\$548	\$395	N/A
Z18S36TR	16 x 18 x 35.5-36	100	74.72	7.50	\$495	\$521	\$357	N/A
Z16S36TR	16 x 16 x 35.5-36	92.5	67.82	6.75	\$452	\$478	\$352	N/A
Z15S36TR	16 x 15 x 35.5-36	92.5	66.46	6.50	\$429	\$450	\$312	N/A
Z12S36TR	16 x 12 x 35.5-36	92.5	59.30	5.25	\$399	\$416	\$282	N/A

Designed to be placed **on top of 29"/29.5" high units to achieve 65"/66" final height.** Laminate door is standard.
Includes two adjustable shelves. Standard with lock.

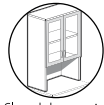
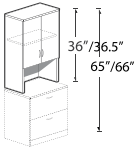

Glazed door option

**Table Top Bookcase with Doors and
Cavity - 36"/36.5" High**

Z36S36TC	16 x 36 x 35.5-36	100	116.98	14.25	\$689	\$734	\$637	N/A
Z30S36TC	16 x 30 x 35.5-36	100	100.58	12	\$598	\$636	\$554	N/A

Designed to be placed **on top of 29"/29.5" high units to achieve 65"/66" final height.** Laminate doors are standard.
Includes one adjustable shelf. Standard with lock.

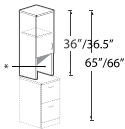

* Accepts collator 11" high

**Table Top Bookcase with Doors and
Cavity - 36"/36.5" High - LEFT**

Z21S36TCL	16 x 21 x 35.5-36	100	78.72	8.75	\$492	\$523	\$353	N/A
Z18S36TCL	16 x 18 x 35.5-36	100	71.07	7.50	\$474	\$501	\$318	N/A
Z16S36TCL	16 x 16 x 35.5-36	100	64.57	6.75	\$430	\$456	\$312	N/A
Z15S36TCL	16 x 15 x 35.5-36	100	63.42	6.50	\$413	\$433	\$276	N/A
Z12S36TCL	16 x 12 x 35.5-36	92.5	56.87	5.25	\$384	\$402	\$248	N/A

Designed to be placed **on top of 29"/29.5" high units to achieve 65"/66" final height.** Laminate door is standard.
Includes one adjustable shelf. Standard with lock.

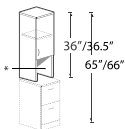

* Accepts collator 11" high

**Table Top Bookcase with Doors and
Cavity - 36"/36.5" High - RIGHT**

Z21S36TCR	16 x 21 x 35.5-36	100	78.72	8.75	\$492	\$523	\$353	N/A
Z18S36TCR	16 x 18 x 35.5-36	100	71.07	7.50	\$474	\$501	\$318	N/A
Z16S36TCR	16 x 16 x 35.5-36	100	64.57	6.75	\$430	\$456	\$312	N/A
Z15S36TCR	16 x 15 x 35.5-36	100	63.42	6.50	\$413	\$433	\$276	N/A
Z12S36TCR	16 x 12 x 35.5-36	92.5	56.87	5.25	\$384	\$402	\$248	N/A

Designed to be placed **on top of 29"/29.5" high units to achieve 65"/66" final height.** Laminate door is standard.
Includes one adjustable shelf. Standard with lock.

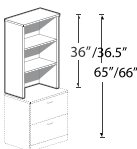

Table Top Bookcase 36"/36.5" High

Z36S36TN	16 x 36 x 35.5-36	125	95.31	14.25	\$490	\$536	N/A	N/A
Z30S36TN	16 x 30 x 35.5-36	125	82.38	12	\$418	\$456	N/A	N/A

Designed to be placed **on top of 29"/29.5" high units to achieve 65"/66" final height.** **Includes two adjustable shelves.**

Required Specifications

Finishes
Top/Edge Detail

Optional Specifications

Collator (Open Shelves)
Glazing - Doors

TABLE TOP BOOKCASES

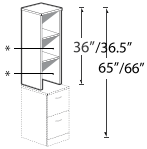

* Accepts collator 11\"/>

Table Top Bookcase 36\"/>

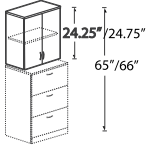

Glazed door option

Table Top Bookcase with Doors
24.25\"/>

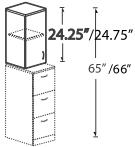

Glazed door option

Table Top Bookcase with Door - LEFT
24.25\"/>

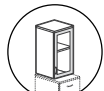
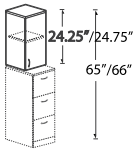

Glazed door option

Table Top Bookcase with Door - RIGHT
24.25\"/>

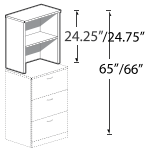
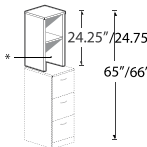

Table Top Bookcase
24.25\"/>



* Accepts collator 11\"/>

Table Top Bookcase
24.25\"/>

MODEL#	DIMENSIONS	FREIGHT CLASS	WT/LBS.	CUBIC FT.	1\"/>			
Z21S36TN	16 x 21 x 35.5-36	125	65.62	8.75	\$378	\$409	N/A	N/A
Z18S36TN	16 x 18 x 35.5-36	125	59.68	7.50	\$368	\$395	N/A	N/A
Z16S36TN	16 x 16 x 35.5-36	100	56	6.75	\$325	\$351	N/A	N/A
Z15S36TN	16 x 15 x 35.5-36	100	53.74	6.50	\$315	\$336	N/A	N/A
Z12S36TN	16 x 12 x 35.5-36	125	48.85	6.25	\$294	\$311	N/A	N/A

Designed to be placed on top of 29\"/>

MODEL#	DIMENSIONS	FREIGHT CLASS	WT/LBS.	CUBIC FT.	1\"/>			
Z36S24T	16 x 36 x 23.75-24.25	100	89.26	10	\$569	\$614	\$637	N/A
Z30S24T	16 x 30 x 23.75-24.25	100	77.47	8.25	\$519	\$556	\$554	N/A

Designed to be placed on top of 40.8\"/>

MODEL#	DIMENSIONS	FREIGHT CLASS	WT/LBS.	CUBIC FT.	1\"/>			
Z21S24TL	16 x 21 x 23.75-24.25	100	59.24	6	\$404	\$435	\$353	N/A
Z18S24TL	16 x 18 x 23.75-24.25	92.5	56.11	5.25	\$391	\$417	\$318	N/A
Z16S24TL	16 x 16 x 23.75-24.25	92.5	48.13	4.60	\$346	\$372	\$312	N/A
Z15S24TL	16 x 15 x 23.75-24.25	92.5	46.35	4.30	\$328	\$349	\$276	N/A
Z12S24TL	16 x 12 x 23.75-24.25	85	44.32	3.60	\$306	\$323	\$248	N/A

Designed to be placed on top of 40.8\"/>

MODEL#	DIMENSIONS	FREIGHT CLASS	WT/LBS.	CUBIC FT.	1\"/>			
Z21S24TR	16 x 21 x 23.75-24.25	100	59.24	6	\$404	\$435	\$353	N/A
Z18S24TR	16 x 18 x 23.75-24.25	92.5	56.11	5.25	\$391	\$417	\$318	N/A
Z16S24TR	16 x 16 x 23.75-24.25	92.5	48.13	4.60	\$346	\$372	\$312	N/A
Z15S24TR	16 x 15 x 23.75-24.25	92.5	46.35	4.30	\$328	\$349	\$276	N/A
Z12S24TR	16 x 12 x 23.75-24.25	85	44.32	3.60	\$306	\$323	\$248	N/A

Designed to be placed on top of 40.8\"/>

MODEL#	DIMENSIONS	FREIGHT CLASS	WT/LBS.	CUBIC FT.	1\"/>			
Z36S24TN	16 x 36 x 23.75-24.25	125	70.11	10	\$371	\$417	N/A	N/A
Z30S24TN	16 x 30 x 23.75-24.25	125	61.38	8.25	\$340	\$378	N/A	N/A

Designed to be placed on top of 40.8\"/>

MODEL#	DIMENSIONS	FREIGHT CLASS	WT/LBS.	CUBIC FT.	1\"/>			
Z21S24TN	16 x 21 x 23.75-24.25	125	47.77	6	\$290	\$321	N/A	N/A
Z18S24TN	16 x 18 x 23.75-24.25	100	46.03	5.25	\$285	\$312	N/A	N/A
Z16S24TN	16 x 16 x 23.75-24.25	100	39.27	4.60	\$241	\$267	N/A	N/A
Z15S24TN	16 x 15 x 23.75-24.25	100	37.99	4.30	\$231	\$252	N/A	N/A
Z12S24TN	16 x 12 x 23.75-24.25	92.5	37.30	3.60	\$216	\$233	N/A	N/A

Designed to be placed on top of 40.8\"/>

Required Specifications

Finishes
Top/Edge Detail

Optional Specifications

Collator (Open Shelves)
Glazing - Doors

TABLE TOP BOOKCASES

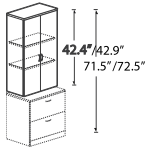

Glazed door option

Table Top Bookcase with Doors
42.4"/42.9" High

MODEL#	DIMENSIONS D x W x H	FREIGHT CLASS	WT/LBS.	CUBIC FT.	1" TOP	1.5" TOP	GLAZE ADD	HP ADD
Z36S42T	16 x 36 x 41.9-42.4	100	137.40	16.75	\$797	\$842	\$886	N/A
Z30S42T	16 x 30 x 41.9-42.4	100	119.06	14	\$696	\$734	\$771	N/A

Designed to be placed **on top of 29"/29.5" high units to achieve 71.5"/72.5" final height.** DO NOT USE ON TOP OF 40.8"/41.3" HIGH UNITS. Laminate doors are standard. **Includes two adjustable shelves.** Standard with lock.

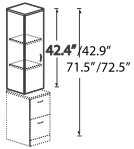

Glazed door option

Table Top Bookcase with Door - LEFT
42.4"/42.9" High

Z21S42TL	16 x 21 x 41.9-42.4	300	119	70	\$564	\$595	\$489	N/A
Z18S42TL	16 x 18 x 41.9-42.4	85	117	8.75	\$541	\$567	\$439	N/A
Z16S42TL	16 x 16 x 41.9-42.4	300	112	62	\$487	\$513	\$435	N/A
Z15S42TL	16 x 15 x 41.9-42.4	250	109	54	\$462	\$482	\$382	N/A
Z12S42TL	16 x 12 x 41.9-42.4	250	105	49	\$429	\$447	\$344	N/A

Designed to be placed **on top of 29"/29.5" high units to achieve 71.5"/72.5" final height.** DO NOT USE ON TOP OF 40.8"/41.3" HIGH UNITS. Laminate door is standard. **Includes two adjustable shelves.** Standard with lock.

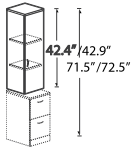

Glazed door option

Table Top Bookcase with Door - RIGHT
42.4"/42.9" High

Z21S42TR	16 x 21 x 41.9-42.4	300	119	70	\$564	\$595	\$489	N/A
Z18S42TR	16 x 18 x 41.9-42.4	85	117	8.75	\$541	\$567	\$439	N/A
Z16S42TR	16 x 16 x 41.9-42.4	300	112	62	\$487	\$513	\$435	N/A
Z15S42TR	16 x 15 x 41.9-42.4	250	109	54	\$462	\$482	\$382	N/A
Z12S42TR	16 x 12 x 41.9-42.4	250	105	49	\$429	\$447	\$344	N/A

Designed to be placed **on top of 29"/29.5" high units to achieve 71.5"/72.5" final height.** DO NOT USE ON TOP OF 40.8"/41.3" HIGH UNITS. Laminate door is standard. **Includes two adjustable shelves.** Standard with lock.

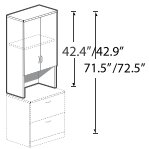

Glazed door option

Table Top Bookcase with Doors and
Cavity 42.4"/42.9" High

Z36S42TC	16 x 36 x 41.9-42.4	125	130.09	16.75	\$771	\$816	\$697	N/A
Z30S42TC	16 x 30 x 41.9-42.4	100	112.97	14	\$674	\$712	\$606	N/A

Designed to be placed **on top of 29"/29.5" high units to achieve 71.5"/72.5" final height.** DO NOT USE ON TOP OF 40.8"/41.3" HIGH UNITS. Laminate doors are standard. **Includes one adjustable shelf.** Standard with lock.

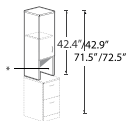

Glazed door option



* Accepts collator 11" high

Table Top Bookcase with Door and
Cavity 42.4"/42.9" High - LEFT

Z21S42TCL	16 x 21 x 41.9-42.4	100	87.84	10	\$551	\$581	\$386	N/A
Z18S42TCL	16 x 18 x 41.9-42.4	100	79.83	8.75	\$529	\$555	\$347	N/A
Z16S42TCL	16 x 16 x 41.9-42.4	100	73.75	8	\$474	\$500	\$343	N/A
Z15S42TCL	16 x 15 x 41.9-42.4	100	70.71	7.50	\$452	\$472	\$302	N/A
Z12S42TCL	16 x 12 x 41.9-42.4	92.5	62.70	6	\$419	\$437	\$271	N/A

Designed to be placed **on top of 29"/29.5" high units to achieve 71.5"/72.5" final height.** DO NOT USE ON TOP OF 40.8"/41.3" HIGH UNITS. Laminate door is standard. **Includes one adjustable shelf.** Standard with lock.

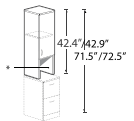

Glazed door option



* Accepts collator 11" high

Table Top Bookcase with Door and
Cavity 42.4"/42.9" High - RIGHT

Z21S42TCR	16 x 21 x 41.9-42.4	100	87.84	10	\$551	\$581	\$386	N/A
Z18S42TCR	16 x 18 x 41.9-42.4	100	79.83	8.75	\$529	\$555	\$347	N/A
Z16S42TCR	16 x 16 x 41.9-42.4	100	73.75	8	\$474	\$500	\$343	N/A
Z15S42TCR	16 x 15 x 41.9-42.4	100	70.71	7.50	\$452	\$472	\$302	N/A
Z12S42TCR	16 x 12 x 41.9-42.4	92.5	62.70	6	\$419	\$437	\$271	N/A

Designed to be placed **on top of 29"/29.5" high units to achieve 71.5"/72.5" final height.** DO NOT USE ON TOP OF 40.8"/41.3" HIGH UNITS. Laminate door is standard. **Includes one adjustable shelf.** Standard with lock.

Required Specifications

Finishes
Top/Edge Detail

Optional Specifications

Collator (Open Shelves)
Glazing - Doors

TABLE TOP BOOKCASES

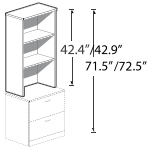
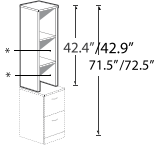
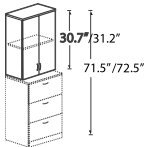

Table Top Bookcase
42.4\"/>



* Accepts collator 11\"/>

Table Top Bookcase
42.4\"/>



Glazed door option

Table Top Bookcase with Doors
30.7\"/>

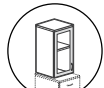
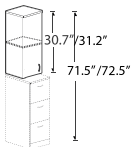

Glazed door option

Table Top Bookcase with Door
30.7\"/>

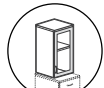
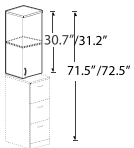

Glazed door option

Table Top Bookcase with Door
30.7\"/>

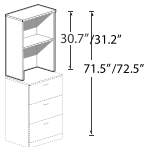

Table Top Bookcase
30.7\"/>

MODEL#	DIMENSIONS	FREIGHT CLASS	WT/LBS.	CUBIC FT.	1\"/>			
Z36S42TN	16 x 36 x 41.9-42.4	125	103.71	16.75	\$534	\$579	N/A	N/A
Z30S42TN	16 x 30 x 41.9-42.4	125	90.78	14	\$464	\$502	N/A	N/A

Designed to be placed **on top of 29\"/>**

MODEL#	D x W x H	FREIGHT CLASS	WT/LBS.	CUBIC FT.	1\"/>			
Z21S42TN	16 x 21 x 41.9-42.4	125	71.92	10	\$413	\$444	N/A	N/A
Z18S42TN	16 x 18 x 41.9-42.4	125	65.98	8.75	\$404	\$430	N/A	N/A
Z16S42TN	16 x 16 x 41.9-42.4	125	61.32	8	\$349	\$375	N/A	N/A
Z15S42TN	16 x 15 x 41.9-42.4	125	58.99	7.50	\$340	\$361	N/A	N/A
Z12S42TN	16 x 12 x 41.9-42.4	100	53.05	6	\$317	\$334	N/A	N/A

Designed to be placed **on top of 29\"/>**

Z36S31T	16 x 36 x 30.2-30.7	100	104.19	12.25	\$626	\$671	\$697	N/A
Z30S31T	16 x 30 x 30.2-30.7	100	89.36	10.50	\$561	\$599	\$606	N/A

Designed to be placed **on top of 40.8\"/>**

Z21S31TL	16 x 21 x 30.2-30.7	100	69.88	7.50	\$447	\$478	\$386	N/A
Z18S31TL	16 x 18 x 30.2-30.7	92.5	65.22	6.50	\$410	\$436	\$347	N/A
Z16S31TL	16 x 16 x 30.2-30.7	92.5	59.18	5.75	\$391	\$417	\$343	N/A
Z15S31TL	16 x 15 x 30.2-30.7	92.5	56.15	5.50	\$372	\$392	\$302	N/A
Z12S31TL	16 x 12 x 30.2-30.7	92.5	50.39	4.40	\$347	\$365	\$271	N/A

Designed to be placed **on top of 40.8\"/>**

Z21S31TR	16 x 21 x 30.2-30.7	100	69.88	7.50	\$447	\$478	\$386	N/A
Z18S31TR	16 x 18 x 30.2-30.7	92.5	65.22	6.50	\$410	\$436	\$347	N/A
Z16S31TR	16 x 16 x 30.2-30.7	92.5	59.18	5.75	\$391	\$417	\$343	N/A
Z15S31TR	16 x 15 x 30.2-30.7	92.5	56.15	5.50	\$372	\$392	\$302	N/A
Z12S31TR	16 x 12 x 30.2-30.7	92.5	50.39	4.40	\$347	\$365	\$271	N/A

Designed to be placed **on top of 40.8\"/>**

Z36S31TN	16 x 36 x 30.2-30.7	125	79.56	12.25	\$407	\$452	N/A	N/A
Z30S31TN	16 x 30 x 30.2-30.7	125	68.73	10.50	\$366	\$403	N/A	N/A

Designed to be placed **on top of 40.8\"/>**

Required Specifications

Finishes
Top/Edge Detail

Optional Specifications

Collator (Open Shelves)
Glazing - Doors

TABLE TOP BOOKCASES

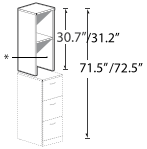

* Accepts collator 11" high

Table Top Bookcase
30.7"/31.2" High

MODEL#	DIMENSIONS D x W x H	FREIGHT CLASS	WT./LBS.	CUBIC FT.	1" TOP	1.5" TOP	GLAZE ADD	HP ADD
Z21S31TN	16 x 21 x 30.2-30.7	125	55.12	7.50	\$321	\$351	N/A	N/A
Z18S31TN	16 x 18 x 30.2-30.7	100	52.33	6.50	\$293	\$319	N/A	N/A
Z16S31TN	16 x 16 x 30.2-30.7	100	47.67	5.75	\$276	\$302	N/A	N/A
Z15S31TN	16 x 15 x 30.2-30.7	100	45.34	5.50	\$267	\$287	N/A	N/A
Z12S31TN	16 x 12 x 30.2-30.7	100	41.50	4.40	\$249	\$266	N/A	N/A

Designed to be placed on top of 40.8"/41.8" high units to achieve 71.5"/72.5" final height. Includes one adjustable shelf.

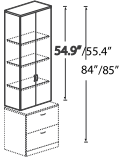

Glazed door option

Table Top Bookcase with Doors
54.9"/55.4" High

Z36S55T	16 x 36 x 54.4-54.9	100	174.25	21.50	\$970	\$1015	\$1022	N/A
Z30S55T	16 x 30 x 54.4-54.9	100	152.16	18	\$885	\$923	\$881	N/A

Designed to be placed on top of 29"/29.5" high units to achieve 84"/85" final height. Includes three adjustable shelves. Standard with lock.

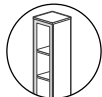
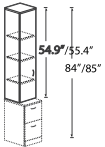

Glazed door option

Table Top Bookcase with Door - LEFT
54.9"/55.4" High

Z21S55TL	16 x 21 x 54.4-54.9	100	116.26	13	\$687	\$718	\$567	N/A
Z18S55TL	16 x 18 x 54.4-54.9	100	104.66	11.25	\$646	\$673	\$508	N/A
Z16S55TL	16 x 16 x 54.4-54.9	100	97.67	10	\$615	\$641	\$502	N/A
Z15S55TL	16 x 15 x 54.4-54.9	100	94.17	9.50	\$586	\$606	\$437	N/A
Z12S55TL	16 x 12 x 54.4-54.9	92.5	83.67	7.75	\$544	\$561	\$391	N/A

Designed to be placed on top of 29"/29.5" high units to achieve 84"/85" final height. Laminate door is standard. Includes three adjustable shelves. Standard with lock.

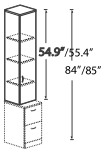

Glazed door option

Table Top Bookcase with Door - RIGHT
54.9"/55.4" High

Z21S55TR	16 x 21 x 54.4-54.9	100	116.26	13	\$687	\$718	\$567	N/A
Z18S55TR	16 x 18 x 54.4-54.9	100	104.66	11.25	\$646	\$673	\$508	N/A
Z16S55TR	16 x 16 x 54.4-54.9	100	97.67	10	\$615	\$641	\$502	N/A
Z15S55TR	16 x 15 x 54.4-54.9	100	94.17	9.50	\$586	\$606	\$437	N/A
Z12S55TR	16 x 12 x 54.4-54.9	92.5	83.67	7.75	\$544	\$561	\$391	N/A

Designed to be placed on top of 29"/29.5" high units to achieve 84"/85" final height. Laminate door is standard. Includes three adjustable shelves. Standard with lock.

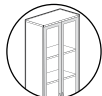
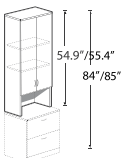

Glazed door option

Table Top Bookcase with Doors
and Cavity 54.9"/55.4" High

Z36S55TC	16 x 36 x 54.4-54.9	125	166.94	21.50	\$944	\$989	\$890	N/A
Z30S55TC	16 x 30 x 54.4-54.9	100	146.06	18	\$863	\$901	\$774	N/A

Designed to be placed on top of 29"/29.5" high units to achieve 84"/85" final height. Laminate doors are standard. Includes two adjustable shelves. Standard with lock.

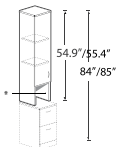

* Accepts collator 11" high

Table Top Bookcase with Door - LEFT
and Cavity 54.9"/55.4" High

Z21S55TCL	16 x 21 x 54.4-54.9	100	112	13	\$664	\$694	\$491	N/A
Z18S55TCL	16 x 18 x 54.4-54.9	100	101.01	11.25	\$625	\$651	\$441	N/A
Z16S55TCL	16 x 16 x 54.4-54.9	100	94.42	10	\$592	\$619	\$436	N/A
Z15S55TCL	16 x 15 x 54.4-54.9	100	91.12	9.50	\$565	\$586	\$384	N/A
Z12S55TCL	16 x 12 x 54.4-54.9	92.5	81.24	7.75	\$525	\$542	\$346	N/A

Designed to be placed on top of 29"/29.5" high units to achieve 84"/85" final height. Laminate door is standard. Includes two adjustable shelves. Standard with lock.

Required Specifications

Finishes
Top/Edge Detail

Optional Specifications

Collator (Open Shelves)
Glazing - Doors

TABLE TOP BOOKCASES

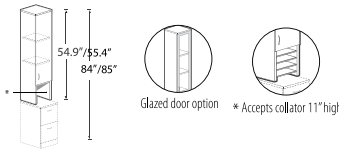

Table Top Bookcase with Door - RIGHT and Cavity - 54.9\"/>

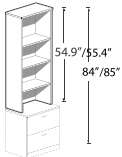

Table Top Bookcase 54.9\"/>

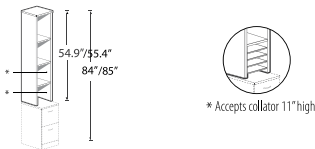

Table Top Bookcase 54.9\"/>

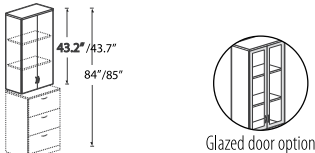

Table Top Bookcase with Doors 43.2\"/>

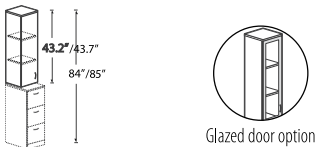

Table Top Bookcase with Door 43.2\"/>



Table Top Bookcase with Door 43.2\"/>

MODEL#	DIMENSIONS	FREIGHT CLASS	WT/LBS.	CUBIC FT.	1\"/>				
D x W x H									
Z21S55TCR	16 x 21 x 54.4-54.9	100	112	13	\$664	\$694	\$491	N/A	
Z18S55TCR	16 x 18 x 54.4-54.9	100	101.01	11.25	\$625	\$651	\$441	N/A	
Z16S55TCR	16 x 16 x 54.4-54.9	100	94.42	10	\$592	\$619	\$436	N/A	
Z15S55TCR	16 x 15 x 54.4-54.9	100	91.12	9.50	\$565	\$586	\$384	N/A	
Z12S55TCR	16 x 12 x 54.4-54.9	92.5	81.24	7.75	\$525	\$542	\$346	N/A	

Designed to be placed **on top of 29\"/>**

Z36S55TN	16 x 36 x 54.4-54.9	125	129.96	21.50	\$645	\$690	N/A	N/A
Z30S55TN	16 x 30 x 54.4-54.9	125	114.93	18	\$600	\$637	N/A	N/A

Designed to be placed **on top of 29\"/>**

Z21S55TN	16 x 21 x 54.4-54.9	125	89.77	13	\$501	\$531	N/A	N/A
Z18S55TN	16 x 18 x 54.4-54.9	125	81.73	11.25	\$478	\$504	N/A	N/A
Z16S55TN	16 x 16 x 54.4-54.9	125	77.07	10	\$446	\$472	N/A	N/A
Z15S55TN	16 x 15 x 54.4-54.9	125	74.74	9.50	\$436	\$457	N/A	N/A
Z12S55TN	16 x 12 x 54.4-54.9	100	67.75	7.75	\$407	\$424	N/A	N/A

Designed to be placed **on top of 29\"/>**

Z36S43T	16 x 36 x 42.7-43.2	100	139.22	17	\$813	\$858	\$890	N/A
Z30S43T	16 x 30 x 42.7-43.2	100	120.76	14.50	\$696	\$734	\$774	N/A

Designed to be placed **on top of 40.8\"/>**

Z21S43TL	16 x 21 x 42.7-43.2	100	93.62	10.25	\$576	\$606	\$491	N/A
Z18S43TL	16 x 18 x 42.7-43.2	100	84.94	9	\$551	\$577	\$441	N/A
Z16S43TL	16 x 16 x 42.7-43.2	100	78.42	8	\$494	\$520	\$436	N/A
Z15S43TL	16 x 15 x 42.7-43.2	92.5	75.16	7.50	\$464	\$484	\$384	N/A
Z12S43TL	16 x 12 x 42.7-43.2	92.5	66.48	6.25	\$430	\$448	\$346	N/A

Designed to be placed **on top of 40.8\"/>**

Z21S43TR	16 x 21 x 42.7-43.2	100	93.62	10.25	\$576	\$606	\$491	N/A
Z18S43TR	16 x 18 x 42.7-43.2	100	84.94	9	\$551	\$577	\$441	N/A
Z16S43TR	16 x 16 x 42.7-43.2	100	78.42	8	\$494	\$520	\$436	N/A
Z15S43TR	16 x 15 x 42.7-43.2	92.5	75.16	7.50	\$464	\$484	\$384	N/A
Z12S43TR	16 x 12 x 42.7-43.2	92.5	66.48	6.25	\$430	\$448	\$346	N/A

Designed to be placed **on top of 40.8\"/>**

Required Specifications

Finishes
Top/Edge Detail

Optional Specifications

Collator (Open Shelves)
Glazing - Doors

TABLE TOP BOOKCASES

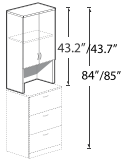

Glazed door option

Table Top Bookcase with Doors and Cavity - 43.2\"/>

MODEL#	DIMENSIONS D x W x H	FREIGHT CLASS	WT/LBS.	CUBIC FT.	1\"/>			
Z36S43TC	16 x 36 x 42.7-43.2	125	131.91	17	\$787	\$832	\$700	N/A
Z30S43TC	16 x 30 x 42.7-43.2	125	114.67	14.50	\$688	\$725	\$596	N/A

Designed to be placed **on top of 40.8\"/>**

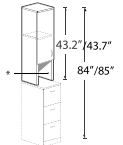

Glazed door option



* Accepts collator 11\"/>

Table Top Bookcase with Door and Cavity - 43.2\"/>

Z21S43TCL	16 x 21 x 42.7-43.2	100	89.36	10.25	\$561	\$592	\$385	N/A
Z18S43TCL	16 x 18 x 42.7-43.2	100	81.29	9	\$537	\$563	\$346	N/A
Z16S43TCL	16 x 16 x 42.7-43.2	100	75.17	8	\$481	\$507	\$342	N/A
Z15S43TCL	16 x 15 x 42.7-43.2	100	72.11	7.50	\$453	\$473	\$301	N/A
Z12S43TCL	16 x 12 x 42.7-43.2	92.5	64.05	6.25	\$420	\$438	\$271	N/A

Designed to be placed **on top of 40.8\"/>**

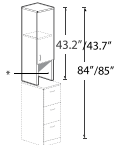

Glazed door option



* Accepts collator 11\"/>

Table Top Bookcase with Door and Cavity - 43.2\"/>

Z21S43TCR	16 x 21 x 42.7-43.2	100	89.36	10.25	\$561	\$592	\$385	N/A
Z18S43TCR	16 x 18 x 42.7-43.2	100	81.29	9	\$537	\$563	\$346	N/A
Z16S43TCR	16 x 16 x 42.7-43.2	100	75.17	8	\$481	\$507	\$342	N/A
Z15S43TCR	16 x 15 x 42.7-43.2	100	72.11	7.50	\$453	\$473	\$301	N/A
Z12S43TCR	16 x 12 x 42.7-43.2	92.5	64.05	6.25	\$420	\$438	\$271	N/A

Designed to be placed **on top of 40.8\"/>**

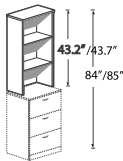
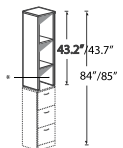

Table Top Bookcase 43.2\"/>

Z36S43TN	16 x 36 x 42.7-43.2	125	104.76	17	\$550	\$595	N/A	N/A
Z30S43TN	16 x 30 x 42.7-43.2	125	91.83	14.50	\$477	\$515	N/A	N/A

Designed to be placed **on top of 40.8\"/>**



* Accepts collator 11\"/>

Table Top Bookcase* 43.2\"/>

Z21S43TN	16 x 21 x 42.7-43.2	125	72.97	10.25	\$424	\$455	N/A	N/A
Z18S43TN	16 x 18 x 42.7-43.2	125	67.03	9	\$412	\$438	N/A	N/A
Z16S43TN	16 x 16 x 42.7-43.2	125	62.37	8	\$355	\$381	N/A	N/A
Z15S43TN	16 x 15 x 42.7-43.2	100	60.04	7.50	\$341	\$362	N/A	N/A
Z12S43TN	16 x 12 x 42.7-43.2	100	54.10	6.25	\$318	\$335	N/A	N/A

Designed to be placed **on top of 40.8\"/>**

Required Specifications

Finishes
Top/edge detail

Optional Specifications

Collator**
Glazed doors*

END SHELVES

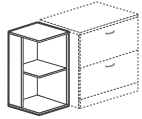

End Shelf - LEFT 29"/29.5" High*

MODEL#	DIMENSIONS	FREIGHT CLASS	WT/LBS.	CUBIC FT.	1" TOP	1.5" TOP	GLAZE ADD	HP ADD
D x W x H								
Z24L2ESHL	24 x 24 x 29-29.5	70	99.75	4.75	\$471	\$508	N/A	\$91
Z20M2ESHL	20 x 20 x 29-29.5	70	76.65	3.75	\$391	\$419	N/A	\$57
Z16S2ESHL	16 x 16 x 29-29.5	65	53.55	2.25	\$331	\$357	N/A	\$57

For use at **LEFT end of 29"/29.5"H units. One adjustable shelf.** Shipped RTA (ready to assemble).

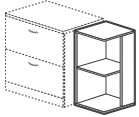

End Shelf - RIGHT 29"/29.5" High*

Z24L2ESHR	24 x 24 x 29-29.5	70	99.75	4.75	\$471	\$508	N/A	\$91
Z20M2ESHR	20 x 20 x 29-29.5	70	76.65	3.75	\$391	\$419	N/A	\$57
Z16S2ESHR	16 x 16 x 29-29.5	65	53.55	2.25	\$331	\$357	N/A	\$57

For use at **RIGHT end of 29"/29.5"H units. One adjustable shelf.** Shipped RTA (ready to assemble).

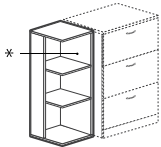

* Accepts collator 11" high

End Shelf - LEFT 40.8"/41.3" High**

Z24L4ESHL	24 x 24 x 40.8-41.3	65	130.20	4.75	\$605	\$643	N/A	N/A
Z20M4ESHL	20 x 20 x 40.8-41.3	60	101	3.25	\$508	\$536	N/A	N/A
Z16S4ESHL	16 x 16 x 40.8-41.3	65	73.87	2.50	\$431	\$457	N/A	N/A

For use at **LEFT end of 40.8"/41.3"H units. Two adjustable shelves.** Shipped RTA (ready to assemble).

- Collator only available on **Z16S4ESHL**

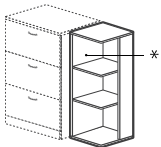

* Accepts collator 11" high

End Shelf - RIGHT 40.8"/41.3" High**

Z24L4ESHR	24 x 24 x 40.8-41.3	65	130.20	4.75	\$605	\$643	N/A	N/A
Z20M4ESHR	20 x 20 x 40.8-41.3	60	101	3.25	\$508	\$536	N/A	N/A
Z16S4ESHR	16 x 16 x 40.8-41.3	65	73.87	2.50	\$431	\$457	N/A	N/A

For use at **RIGHT end of 40.8"/41.3"H units. Two adjustable shelves.** Shipped RTA (ready to assemble).

- Collator only available on **Z16S4ESHR**

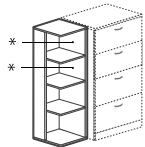

* Accepts collator 11" high

End Shelf - LEFT 52.5"/53" High**

Z24L5ESHL	24 x 24 x 53-53.5	60	162.75	4.75	\$750	\$787	N/A	N/A
Z20M5ESHL	20 x 20 x 53-53.5	60	125.69	4	\$618	\$646	N/A	N/A
Z16S5ESHL	16 x 16 x 53-53.5	65	91.35	3.25	\$521	\$548	N/A	N/A

For use at **LEFT end of 52.5"/53"H units. Three adjustable shelves.** Shipped RTA (ready to assemble).

- Collator only available on **Z16S5ESHL**

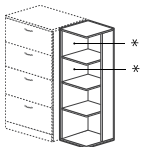

* Accepts collator 11" high

End Shelf - RIGHT 52.5"/53" High**

Z24L5ESHR	24 x 24 x 53-53.5	60	162.75	4.75	\$750	\$787	N/A	N/A
Z20M5ESHR	20 x 20 x 53-53.5	60	125.69	4	\$618	\$646	N/A	N/A
Z16S5ESHR	16 x 16 x 53-53.5	65	91.35	3.25	\$521	\$548	N/A	N/A

For use at **RIGHT end of 52.5"/53"H units. Three adjustable shelves.** Shipped RTA (ready to assemble).

- Collator only available on **Z16S5ESHR**

Required Specifications

Finishes
Top/edge detail

Optional Specifications

Collator**
HP laminate*

END SHELVES

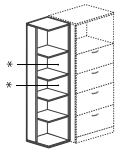

* Accepts collator 11" high

End Shelf - LEFT 65"/65.5" High

MODEL#	DIMENSIONS D x W x H	FREIGHT CLASS	WT/LBS.	CUBIC FT.	1" TOP	1.5" TOP	GLAZE ADD	HP ADD
Z24L6ESHL	24 x 24 x 65-65.5	60	196	6	\$877	\$915	N/A	N/A
Z20M6ESHL	20 x 20 x 65-65.5	60	152	5	\$730	\$758	N/A	N/A
Z16S6ESHL	16 x 16 x 65-65.5	65	111.30	4.25	\$621	\$647	N/A	N/A

For use at **LEFT end of 65"/65.5"H units. Four adjustable shelves.** Shipped RTA (ready to assemble).
 • Collator only available on **Z16S6ESHL**

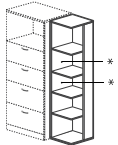

* Accepts collator 11" high

End Shelf - RIGHT 65"/65.5" High

Z24L6ESHR	24 x 24 x 65-65.5	60	196	6	\$877	\$915	N/A	N/A
Z20M6ESHR	20 x 20 x 65-65.5	60	152	5	\$730	\$758	N/A	N/A
Z16S6ESHR	16 x 16 x 65-65.5	65	111.30	4.25	\$621	\$647	N/A	N/A

For use at **RIGHT end of 65"/65.5"H units. Four adjustable shelves.** Shipped RTA (ready to assemble).
 • Collator only available on **Z16S6ESHR**

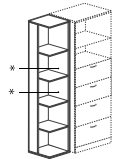

* Accepts collator 11" high

End Shelf - LEFT 71.5"/72" High

Z24L7ESHL	24 x 24 x 72-72.5	60	206.85	6.50	\$921	\$958	N/A	N/A
Z20M7ESHL	20 x 20 x 72-72.5	65	160.65	5.75	\$769	\$797	N/A	N/A
Z16S7ESHL	16 x 16 x 72-72.5	65	117.60	4.75	\$653	\$679	N/A	N/A

For use at **LEFT end of 71.5"/72"H units. Four adjustable shelves.** Shipped RTA (ready to assemble).
 • Collator only available on **Z16S7ESHL**

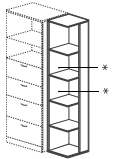

* Accepts collator 11" high

End Shelf - RIGHT 71.5"/72" High

Z24L7ESHR	24 x 24 x 72-72.5	60	206.85	6.50	\$921	\$958	N/A	N/A
Z20M7ESHR	20 x 20 x 72-72.5	65	160.65	5.75	\$769	\$797	N/A	N/A
Z16S7ESHR	16 x 16 x 72-72.5	65	117.60	4.75	\$653	\$679	N/A	N/A

For use at **RIGHT end of 71.5"/72"H units. Four adjustable shelves.** Shipped RTA (ready to assemble).
 • Collator only available on **Z16S7ESHR**

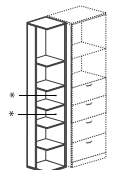

* Accepts collator 11" high

End Shelf - LEFT 84"/84.5" High

Z24L8ESHL	24 x 24 x 84-84.5	60	241.50	7.75	\$1058	\$1095	N/A	N/A
Z20M8ESHL	20 x 20 x 84-84.5	65	185.85	6.50	\$881	\$909	N/A	N/A
Z16S8ESHL	16 x 16 x 84-84.5	65	136.50	5.50	\$748	\$774	N/A	N/A

For use at **LEFT end of 84"/84.5"H units. Five adjustable shelves.** Shipped RTA (ready to assemble).
 • Collator only available on **Z16S8ESHL**

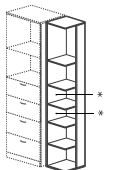

* Accepts collator 11" high

End Shelf - RIGHT 84"/84.5" High

Z24L8ESHR	24 x 24 x 84-84.5	60	241.50	7.75	\$1058	\$1095	N/A	N/A
Z20M8ESHR	20 x 20 x 84-84.5	65	185.85	6.50	\$881	\$909	N/A	N/A
Z16S8ESHR	16 x 16 x 84-84.5	65	136.50	5.50	\$748	\$774	N/A	N/A

For use at **RIGHT end of 84"/84.5"H units. Five adjustable shelves.** Shipped RTA (ready to assemble).
 • Collator only available on **Z16S8ESHR**

Required Specifications

Finishes
 Top/edge detail

Optional Specifications

Collator

TABLE TOP END SHELVES

MODEL# DIMENSIONS FREIGHT CLASS WT/LBS. CUBIC FT. 1" TOP 1.5" TOP GLAZE ADD HP ADD

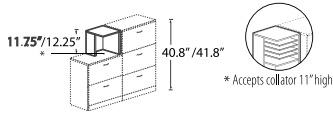

Table Top End Shelf - LEFT
11.75"/12.25" High

D x W x H									
Z16S12DL	16 x 16 x 11.25-11.75	70	26	1.60	\$167	\$193	N/A	N/A	

To be placed **on top of 29"/29.5" units**. For use at **LEFT end of 40.8"/41.8" H units**. Shipped RTA (ready to assemble).

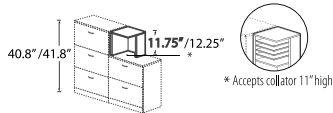

Table Top End Shelf - RIGHT
11.75"/12.25" High

Z16S12DR	16 x 16 x 11.25-11.75	70	26	1.60	\$167	\$193	N/A	N/A	
----------	-----------------------	----	----	------	--------------	--------------	-----	-----	--

To be placed **on top of 29"/29.5" units**. For use at **RIGHT end of 40.8"/41.8" H units**. Shipped RTA (ready to assemble).

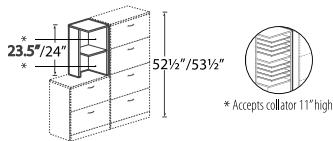

Table Top End Shelf - LEFT
23.5"/24" High

Z16S23DL	16 x 16 x 23-23.5	65	42	1.60	\$258	\$285	N/A	N/A	
----------	-------------------	----	----	------	--------------	--------------	-----	-----	--

To be placed **on top of 29"/29.5" units**. For use at **LEFT end of 52.5"/53" H units**. Shipped RTA (ready to assemble).
One adjustable shelf.

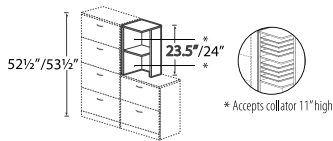

Table Top End Shelf - RIGHT
23.5"/24" High

Z16S23DR	16 x 16 x 23-23.5	65	42	1.60	\$258	\$285	N/A	N/A	
----------	-------------------	----	----	------	--------------	--------------	-----	-----	--

To be placed **on top of 29"/29.5" units**. For use at **RIGHT end of 52.5"/53" H units**. Shipped RTA (ready to assemble).
One adjustable shelf.

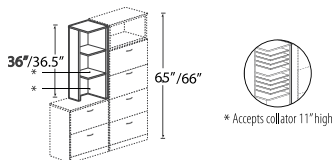

Table Top End Shelf - LEFT
36"/36.5" High

Z16S36DL	16 x 16 x 35.5-36	70	62.84	2.80	\$360	\$386	N/A	N/A	
----------	-------------------	----	-------	------	--------------	--------------	-----	-----	--

To be placed **on top of 29"/29.5" units**. For use at **LEFT end of 65"/65.5" H units**. Shipped RTA (ready to assemble).
Two adjustable shelves.

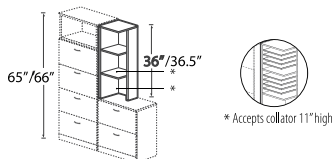

Table Top End Shelf - RIGHT
36"/36.5" High

Z16S36DR	16 x 16 x 35.5-36	70	62.84	2.80	\$360	\$386	N/A	N/A	
----------	-------------------	----	-------	------	--------------	--------------	-----	-----	--

To be placed **on top of 29"/29.5" units**. For use at **RIGHT end of 65"/65.5" H units**. Shipped RTA (ready to assemble).
Two adjustable shelves.

Required Specifications

Finishes
Top/edge detail

Optional Specifications

Collator

TABLE TOP END SHELVES

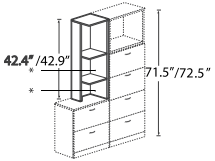

Table Top End Shelf - LEFT*
42.4\"/>



* Accepts collator 11\"/>

MODEL#	DIMENSIONS D x W x H	FREIGHT CLASS	WT/LBS.	CUBIC FT.	1\"/>			
Z16S42DL	16 x 16 x 41.9-42.4	65	70	2.80	\$390	\$416	N/A	N/A

To be placed **on top of 29\"/>**

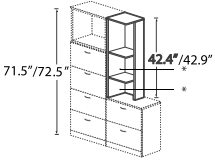

Table Top End Shelf - RIGHT*
42.4\"/>



* Accepts collator 11\"/>

Z16S42DR	16 x 16 x 41.9-42.4	65	70	2.80	\$390	\$416	N/A	N/A
----------	---------------------	----	----	------	--------------	--------------	-----	-----

To be placed **on top of 29\"/>**

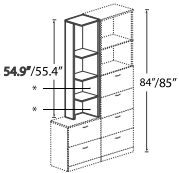

Table Top End Shelf - LEFT*
54.9\"/>



* Accepts collator 11\"/>

Z16S55DL	16 x 16 x 54.4-54.9	60	89	2.80	\$481	\$508	N/A	N/A
----------	---------------------	----	----	------	--------------	--------------	-----	-----

To be placed **on top of 29\"/>**

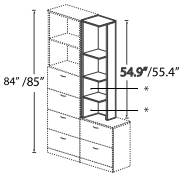

Table Top End Shelf - RIGHT*
54.9\"/>



* Accepts collator 11\"/>

Z16S55DR	16 x 16 x 54.4-54.9	60	89	2.80	\$481	\$508	N/A	N/A
----------	---------------------	----	----	------	--------------	--------------	-----	-----

To be placed **on top of 29\"/>**

ACCESSORIES

LIST PRICE

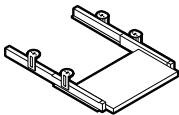

Pull-Out Keyboard

APOKL28	17 x 28 x 3.5	85	13	.90	\$245
APOKL22	17 x 22 x 3.5	85	12	.90	\$221

APOKL28 will accommodate keyboard and mousepad. **APOKL28** will only fit on a single pedestal desk, freestanding table, or **Z42205C**.

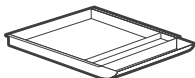

Pencil Drawer

W1518PDR	18 x 15 x 2.25	92.5	4	0.4	\$192
----------	----------------	------	---	-----	--------------

Black ABS plastic. Provides space for writing instruments and small items at the workspace. Attaches to underside of any 24\"/>

Required Specifications

Finishes
Top/edge detail*

Optional Specifications

Collator (Table Top End Shelves)

ACCESSORIES

MODEL#	DIMENSIONS	FREIGHT CLASS	WT/LBS.	CUBIC FT.	1" TOP	1.5" TOP	GLAZE ADD	HP ADD
--------	------------	---------------	---------	-----------	--------	----------	-----------	--------

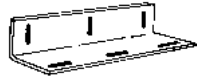

L Bracket

	D x W x H							
MLB90	--	70	1	.01	\$39			

Used to attach worksurfaces to end panels.



LEFT
Skateboard

RIGHT

Z1425SKL (left)	13.9 x 25 x 3.2-3.7	100	13	1.50	\$95			
--------------------	---------------------	-----	----	------	------	--	--	--

Z1425SKR (right)	13.9 x 25 x 3.2-3.7	100	13	1.50	\$95			
---------------------	---------------------	-----	----	------	------	--	--	--

Mobile CPU holder designed to fit inside 'faux' pedestals of a single pedestal desk.

CENTER DRAWERS

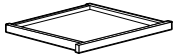

Center Drawer

CD20	18 x 20 x 3	100	8	1	\$150			
------	-------------	-----	---	---	-------	--	--	--

Laminate drawer front is attached to a 4-sided frame. Recommended for use on small L-shaped units, and on 30" x 60" and 66" desks.

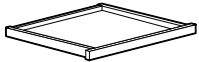

Center Drawer

CD28	18 x 28 x 23	150	5	1	\$197			
------	--------------	-----	---	---	-------	--	--	--

Laminate drawer front is attached to a 4-sided frame. Recommended for use on 36" x 72" desks.

Required Specifications

Finishes

Z ZIRA™ BOARDROOM - NOTES

TOP AND BASE FINISHES

ACJ	Absolute Acajou	ASN	Asian Night
AWC	Avant Cherry	AWH	Avant Honey
BLK	Black	BRC	Brushed Cobalt
CSJ	Constellation Java	DES	Dark Espresso
HGT	Hayden Grey	QTM	Quartered Mahogany
SKC	Shaker Cherry	SOG	Storm Grey
TFW	Tiger Fruitwood	TMA	Tiger Mahogany
TMP	Tiger Maple	TWL	Tiger Walnut
WHT	White	WHC	White Chocolate*
WGY	Willow Grey	WCR	Winter Cherry

*textured, HP non-textured, top only

BASE TRIM FINISHES

BRC	Brushed Cobalt
BLK	Black

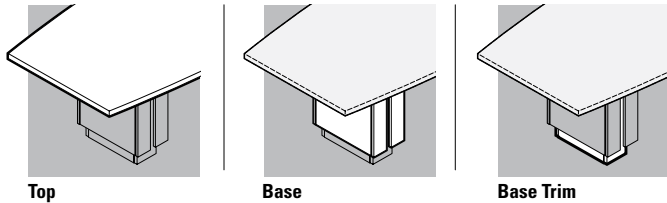

TOP THICKNESS/EDGE DETAIL



BASES

- 2 doors on base for wire management access from both sides

TOPS

- 96" tops are standard in one piece. All tops 120", 144" and 168" tops are standard in two equal size pieces. Woodgrain laminate finishes may NOT align where the two tops join. Tops 192" and larger are standard in 3 equal pieces.
- 96" tops are standard with **two bases**
- Tops 120", 144" and 168" are standard with **three bases**
- Tops 192" and larger are standard with **four bases**
- **Four** top shapes: **Boat shaped, Bow End, Rectangular** and **Racetrack**

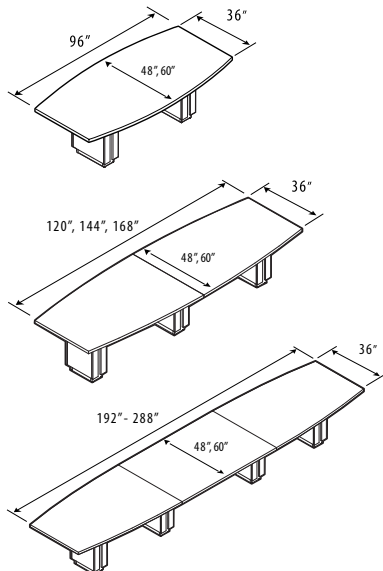

POWER & TECHNOLOGY SOLUTIONS

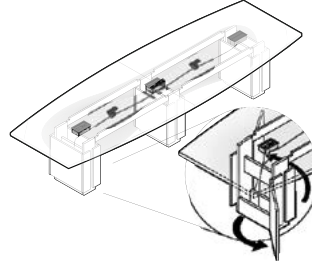

PRODUCT CODE DIAGRAM

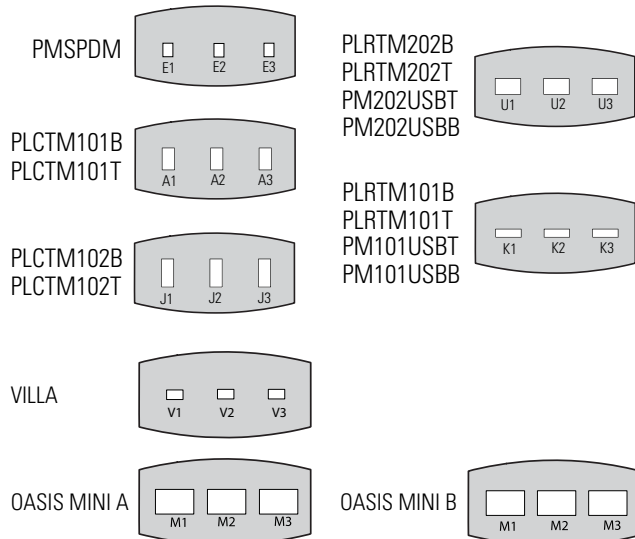

CUT-OUTS

- Optional cut-out available in standard worksurface locations (left, center or right) for all table shapes. **Add \$65 for each cut-out.**
- Select power block option from **Productivity Solutions** section
- Optional Oasis Mini and Villa cut-outs available in standard worksurface locations (left, center or right) **for Rectangular Tables**. Order as: **M1, M2 or M3. Add \$65 for each cut-out.**
- Cut-outs may be placed at non-standard locations. Please contact customer care.
- Match power block desired with cut-out code and location from above grid

AUDIOVISUAL

Three components:
Multimedia Cart

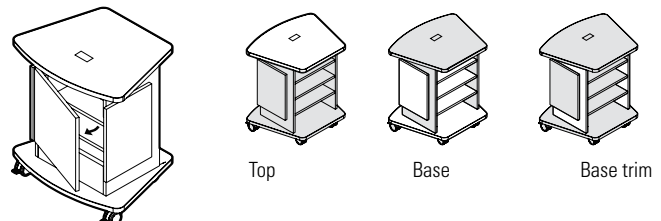

Lectern

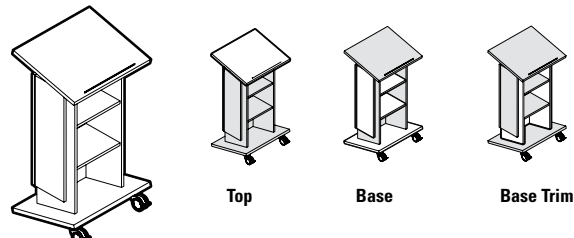

Visual Board

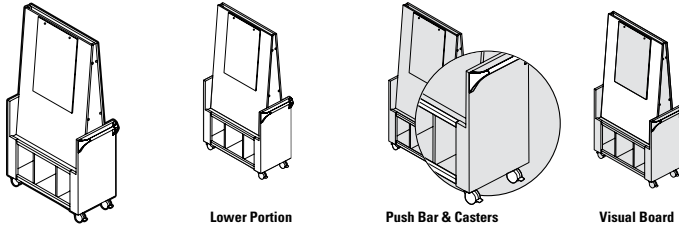

Multimedia Cart and Lectern:

- Available in all laminates listed above
- Color of casters will match base trim
- Offered in the following **top thickness and edge details:**



A3 1" top, standard

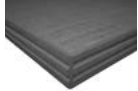

AR 1" top, bicut edge



C3 1.5" top, standard



CR 1.5" top, bicut edge



CF 1.5" top, fluted edge

Visual Board:

- Available in all laminates listed above
- Push Bar available in Black (BK) or Silver (SI)
- Color of casters and aluminum trim will match push bar
- Visual Board comes standard in white color

BUFFET

Three components: **Buffet Carts, Buffets** and **Serving Carts**

- Top and/or base available in all laminates
- Push Bar on Buffet Carts and Serving Carts and Aluminum Trim on Open and Mixed Buffets available in Black (BK) or Silver (SI)
- Optional glazing available on Serving Carts with doors and Buffets with doors

Buffet Carts

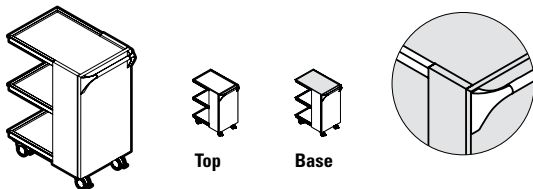

Serving Cart with Doors

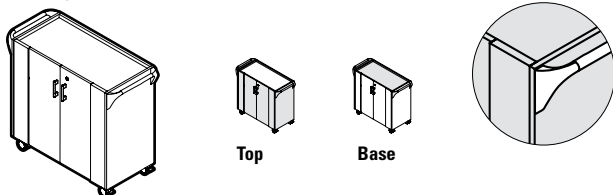

Serving Cart - Open

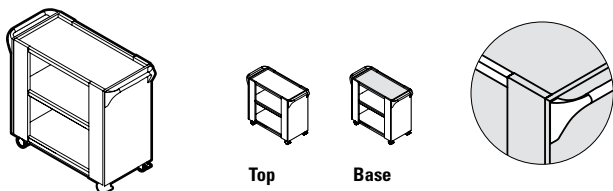

Buffet - Open

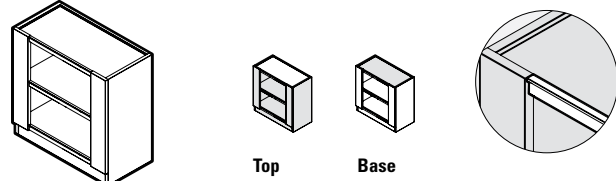

Buffet with Doors

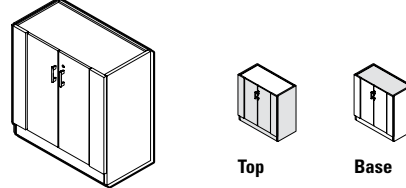

Buffet - Mixed

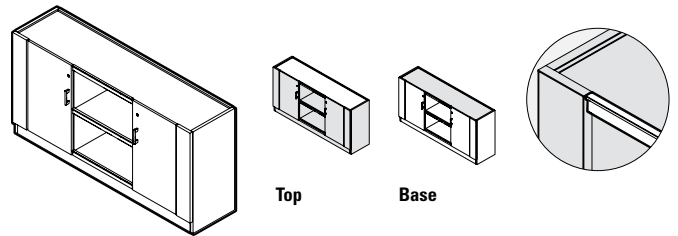

Glazing (Doors - Serving Cart and Buffets)



Z1 Frosted Glazing, Silver Frame



Z2 Frosted Glazing, Black Frame



Z3 Ribbed Glazing, Silver Frame

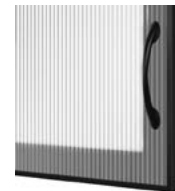

Z4 Ribbed Glazing, Black Frame

Handles

- Handles are standard on models with doors. Each handle is identified by the letters "HU", "HV", "HW", "HX", "HS", "HZ", "HO", "HQ", and "HR". To specify a handle, please specify the code after the model number.



HS Flared Silver



HV Square Edge Silver



HO Crescent Black



HW Flared Brass



HU Square Edge Black



HZ Dimpled Nickel



HX Flared Black



HQ Bar Silver



HR Bar Black

Z ZIRA™ BOARDROOM

TABLE NOTES - ESTIMATED CAPACITY

- Use the following for determining the size of a table and the number of chairs needed for a conference area. All estimates are based on an average chair width of 23" with a 4" clearance between chairs. Adjust accordingly for a different chair size.

Top Size	Rectangular	Bow End	Boat	Racetrack
48x96	6-8	6-8	6-8	6-8
48x120	8-10	8-10	8-10	8-10
48x144	10-12	10-12	10-12	10-12
48x168	12-14	12-14	12-14	12-14
48x192	14-16	14-16	14-16	14-16
48x216	16-18	16-18	16-18	16-18
48x240	18-20	18-20	18-20	18-20
48x264	20-22	20-22	20-22	20-22
48x288	22-24	22-24	22-24	22-24

BOARDROOM TABLES

MODEL#	DIMENSIONS	FREIGHT CLASS	WT/LBS.	CUBIC FT.	1"TOP	1.5" TOP	GLAZE ADD	HP ADD
D x W x H								

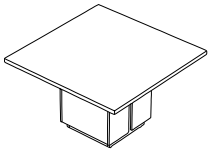

Boardroom Table - Square

Z3636SQ	36 x 36 x 29.5	125	129	20	N/A	\$1704	N/A	\$250
Z4242SQ	42 x 42 x 29.5	125	165.50	27	N/A	\$1940	N/A	\$343
Z4848SQ	48 x 48 x 29.5	125	190	28.50	N/A	\$2102	N/A	\$445
Z5454SQ	54 x 54 x 29.5	125	262	42.50	N/A	\$2352	N/A	\$565
Z6060SQ	60 x 60 x 29.5	125	300	45.50	N/A	\$2514	N/A	\$695

Square Table includes ONE BASE with wire access doors on each side of base. Shipped in 2 cartons.

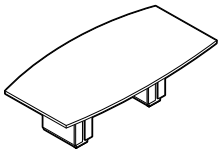

Boardroom Table - Boat Shaped

Z4896BE	48 x 96 x 29.5	70	342	21.95	N/A	\$2778	N/A	\$684
---------	----------------	----	-----	-------	-----	---------------	-----	--------------

Boat Shaped Table includes TWO BASES with wire access doors on each side of base and wire concealment runners between bases. Shipped in 3 cartons.

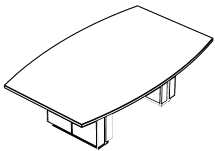

Boardroom Table - Boat Shaped

Z6096BE	60 x 96 x 29.5	150	432	106.2	N/A	\$4510	N/A	\$1112
---------	----------------	-----	-----	-------	-----	---------------	-----	---------------

Boat Shaped Table includes TWO BASES with wire access doors on each side of base and wire concealment runners between bases. Shipped in 3 cartons.

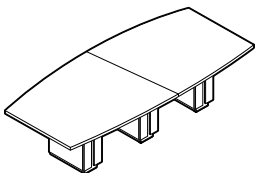

Boardroom Table - Boat Shaped

Z48120BE	48 x 120 x 29.5	70	452	23.48	N/A	\$3995	N/A	\$855
Z48144BE	48 x 144 x 29.5	70	502	25.72	N/A	\$4034	N/A	\$1026
Z48168BE	48 x 168 x 29.5	85	557	37.25	N/A	\$5385	N/A	\$1297

Boat Shaped Table includes THREE BASES with wire access doors on each side of base and wire concealment runners between bases. Z48144BE and Z48120BE shipped in 4 cartons. Z48168BE shipped in 5 cartons.

Required Specifications

Top finish
Top/edge detail
Base finish
Base trim finish

Optional Specifications

HP laminate
Additional grommet

Accessories

Power block

BOARDROOM TABLES

MODEL# DIMENSIONS FREIGHT CLASS WT/LBS. CUBIC FT. 1"TOP 1.5" TOP GLAZE ADD HP ADD

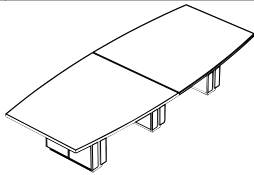

Boardroom Table - Boat Shaped

	D x W x H								
Z60120BE	60 x 120 x 29.5	250	599	242.5	N/A	\$6838	N/A	\$1389	
Z60144BE	60 x 144 x 29.5	250	664.65	266.2	N/A	\$7320	N/A	\$1667	
Z60168BE	60 x 168 x 29.5	250	741.30	290	N/A	\$7894	N/A	\$1945	

Boat Shaped Table includes THREE BASES with wire access doors on each side of base and wire concealment runners between bases. Shipped in 5 cartons.

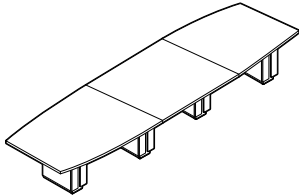

Boardroom Table - Boat Shaped

Z48192BE	48 x 192 x 29.5	70	688	45.66	N/A	\$6727	N/A	\$1482	
Z48216BE	48 x 216 x 29.5	70	746	48.67	N/A	\$7042	N/A	\$1667	
Z48240BE	48 x 240 x 29.5	70	803	51.68	N/A	\$7487	N/A	\$1852	
Z48264BE	48 x 264 x 29.5	70	855	54.69	N/A	\$7931	N/A	\$2038	
Z48288BE	48 x 288 x 29.5	70	906	57.69	N/A	\$7931	N/A	\$2223	

Boat Shaped Table includes FOUR BASES with wire access doors on each side of base and wire concealment runners between bases. Shipped in 7 cartons.

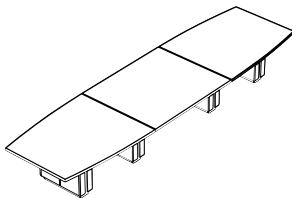

Boardroom Table - Boat Shaped

Z60192BE	60 x 192 x 29.5	300	912.45	498.2	N/A	\$9931	N/A	\$2223	
Z60216BE	60 x 216 x 29.5	300	980.70	531.4	N/A	\$10487	N/A	\$2500	
Z60240BE	60 x 240 x 29.5	300	1062.60	566.	N/A	\$10936	N/A	\$2778	
Z60264BE	60 x 264 x 29.5	300	1129.80	599.	N/A	\$11371	N/A	\$3056	
Z60288BE	60 x 288 x 29.5	300	1198.05	632.	N/A	\$12065	N/A	\$3334	

Boat Shaped Table includes FOUR BASES with wire access doors on each side of base and wire concealment runners between bases. Shipped in 7 cartons.

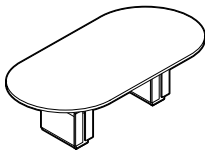

Boardroom Table - Racetrack

Z4896RTE	48 x 96 x 29.5	70	336	21.95	N/A	\$2701	N/A	\$684	
----------	----------------	----	-----	-------	-----	--------	-----	-------	--

Racetrack Shaped Table includes TWO BASES with wire access doors on each side of base and wire concealment runners between bases. Shipped in 3 cartons.

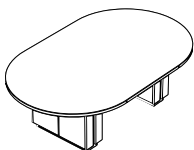

Boardroom Table - Racetrack

Z6096RTE	60 x 96 x 29.5	250	417	106.2	N/A	\$4510	N/A	\$1112	
----------	----------------	-----	-----	-------	-----	--------	-----	--------	--

Racetrack Shaped Table includes TWO BASES with wire access doors on each side of base and wire concealment runners between bases. Shipped in 3 cartons.

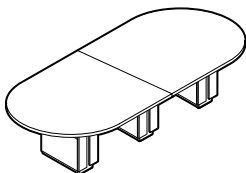

Boardroom Table - Racetrack

Z48120RTE	48 x 120 x 29.5	70	453	28.28	N/A	\$3757	N/A	\$855	
Z48144RTE	48 x 144 x 29.5	70	506	25.72	N/A	\$4005	N/A	\$1026	
Z48168RTE	48 x 168 x 29.5	70	563	37.25	N/A	\$5417	N/A	\$1297	

Racetrack Shaped Table includes THREE BASES with wire access doors on each side of base and wire concealment runners between bases. Z48144RTE and Z48120RTE shipped in 4 cartons. Z48168RTE shipped in 5 cartons.

Required Specifications

Top finish
Top/edge detail
Base finish
Base trim finish

Optional Specifications

HP laminate
Additional grommet

Accessories

Power block

BOARDROOM TABLES

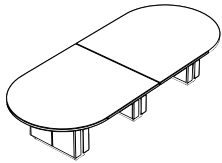

Boardroom Table - Racetrack

MODEL#	DIMENSIONS D x W x H	FREIGHT CLASS	WT/LBS.	CUBIC FT.	1" TOP	1.5" TOP	GLAZE ADD	HP ADD
Z6012ORTE	60 x 120 x 29.5	250	585.90	242.5	N/A	\$6838	N/A	XX
Z60144ORTE	60 x 144 x 29.5	250	656.25	266.2	N/A	\$7320	N/A	\$1667
Z60168ORTE	60 x 168 x 29.5	250	737.10	290	N/A	\$7894	N/A	\$1945

Racetrack Shaped Table includes THREE BASES with wire access doors on each side of base and wire concealment runners between bases. Shipped in 5 cartons.

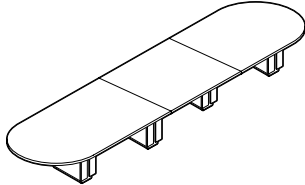

Boardroom Table - Racetrack

Z48192RTE	48 x 192 x 29.5	70	689	45.45	N/A	\$6760	N/A	\$1482
Z48216RTE	48 x 216 x 29.5	70	749	48.95	N/A	\$7075	N/A	\$1667
Z48240RTE	48 x 240 x 29.5	70	809	51.75	N/A	\$7519	N/A	\$1852
Z48264RTE	48 x 264 x 29.5	70	862	54.55	N/A	\$7963	N/A	\$2038
Z48288RTE	48 x 288 x 29.5	70	917	58.04	N/A	\$7963	N/A	\$2223

Racetrack Shaped Table includes FOUR BASES with wire access doors on each side of base and wire concealment runners between bases. Shipped in 7 cartons.

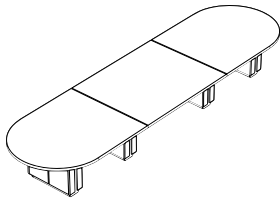

Boardroom Table - Racetrack

Z60192RTE	60 x 192 x 29.5	300	901.95	498.2	N/A	\$9931	N/A	\$2223
Z60216RTE	60 x 216 x 29.5	300	972.30	531.4	N/A	\$10487	N/A	\$2500
Z60240RTE	60 x 240 x 29.5	300	1057.35	566.	N/A	\$10936	N/A	\$2778
Z60264RTE	60 x 264 x 29.5	300	1127.70	599.	N/A	\$11371	N/A	\$3056
Z60288RTE	60 x 288 x 29.5	300	1198.05	632.	N/A	\$12065	N/A	\$3334

Racetrack Shaped Table includes FOUR BASES with wire access doors on each side of base and wire concealment runners between bases. Shipped in 7 cartons.

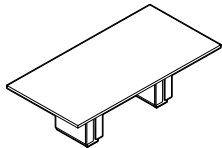

Boardroom Table - Rectangular

Z4896REE	48 x 96 x 29.5	70	356	21.95	N/A	\$2765	N/A	\$684
----------	----------------	----	-----	-------	-----	---------------	-----	--------------

Rectangular Shaped Table includes TWO BASES with wire access doors on each side of base and wire concealment runners between bases. Shipped in 3 cartons.

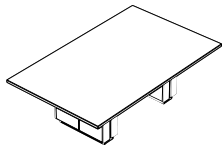

Boardroom Table - Rectangular

Z6096REE	60 x 96 x 29.5	150	448	106.2	N/A	\$4135	N/A	\$1112
----------	----------------	-----	-----	-------	-----	---------------	-----	---------------

Rectangular Shaped Table includes TWO BASES with wire access doors on each side of base and wire concealment runners between bases. Shipped in 3 cartons.

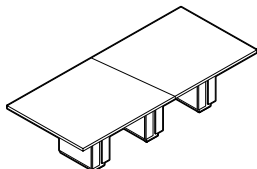

Boardroom Table - Rectangular

Z48120REE	48 x 120 x 29.5	70	472	23.48	N/A	\$3744	N/A	\$855
Z48144REE	48 x 144 x 29.5	70	525	25.72	N/A	\$4009	N/A	\$1026
Z48168REE	48 x 168 x 29.5	70	583	37.25	N/A	\$5338	N/A	\$1297

Rectangular Shaped Table includes THREE BASES with wire access doors on each side of base and wire concealment runners between bases. Z48144REE and Z48120REE shipped in 4 cartons. Z48168REE shipped in 5 cartons.

Required Specifications

Top finish
Top/edge detail
Base finish
Base trim finish

Optional Specifications

HP laminate
Additional grommet

Accessories

Power block

BOARDROOM TABLES

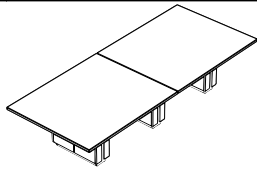

Boardroom Table - Rectangular

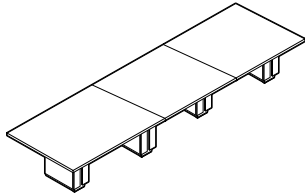

Boardroom Table - Rectangular

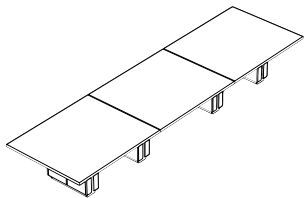

Boardroom Table - Rectangular

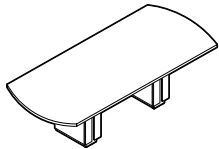

Boardroom Table - Bow End

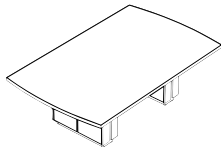

Boardroom Table - Bow End

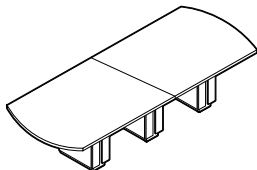

Boardroom Table - Bow End

MODEL#	DIMENSIONS D x W x H	FREIGHT CLASS	WT/LBS.	CUBIC FT.	1" TOP	1.5" TOP	GLAZE ADD	HP ADD
Z60120REE	60 x 120 x 29.5	250	618	242.5	N/A	\$6269	N/A	\$1389
Z60144REE	60 x 144 x 29.5	250	688	266.2	N/A	\$6709	N/A	\$1667
Z60168REE	60 x 168 x 29.5	250	769	290	N/A	\$7227	N/A	\$1945

Rectangular Shaped Table includes THREE BASES with wire access doors on each side of base and wire concealment runners between bases. Shipped in 5 cartons.

Z48192REE	48 x 192 x 29.5	250	708	45.75	N/A	\$6681	N/A	\$1482
Z48216REE	48 x 216 x 29.5	250	768	48.75	N/A	\$6996	N/A	\$1667
Z48240REE	48 x 240 x 29.5	250	828	51.75	N/A	\$7440	N/A	\$1852
Z48264REE	48 x 264 x 29.5	250	882	54.75	N/A	\$7885	N/A	\$2038
Z48288REE	48 x 288 x 29.5	250	936	57.75	N/A	\$7885	N/A	\$2223

Rectangular Shaped Table includes FOUR BASES with wire access doors on each side of base and wire concealment runners between bases. Shipped in 7 cartons.

Z60192REE	60 x 192 x 29.5	300	941.85	498.2	N/A	\$9102	N/A	\$2223
Z60216REE	60 x 216 x 29.5	300	1003.80	1531.	N/A	\$9607	N/A	\$2500
Z60240REE	60 x 240 x 29.5	300	1088.85	1566.	N/A	\$10019	N/A	\$2778
Z60264REE	60 x 264 x 29.5	300	1159.20	1599.	N/A	\$10413	N/A	\$3056
Z60288REE	60 x 288 x 29.5	300	1229.55	1632.	N/A	\$11042	N/A	\$3334

Rectangular Shaped Table includes FOUR BASES with wire access doors on each side of base and wire concealment runners between bases. Shipped in 7 cartons.

Z4896BW	48 x 96 x 29.5	150	329	22	N/A	\$2863	N/A	\$684
---------	----------------	-----	-----	----	-----	---------------	-----	--------------

Bow End Table includes TWO BASES with wire access doors on each side of base and wire concealment runners between bases. Shipped in 3 cartons.

Z6096BW	60 x 96 x 29.5	150	436	106.2	N/A	\$4510	N/A	\$1112
---------	----------------	-----	-----	-------	-----	---------------	-----	---------------

Bow End Table includes TWO BASES with wire access doors on each side of base and wire concealment runners between bases. Shipped in 3 cartons.

Z48120BW	48 x 120 x 29.5	150	476	23.50	N/A	\$3814	N/A	\$855
Z48144BW	48 x 144 x 29.5	150	513	25.75	N/A	\$4083	N/A	\$1026
Z48168BW	48 x 168 x 29.5	250	573	37.25	N/A	\$5362	N/A	\$1297

Bow End Table includes THREE BASES with wire access doors on each side of base and wire concealment runners between bases. Z48144BW and Z48120BW shipped in 4 cartons. Z48168BW shipped in 5 cartons.

Required Specifications

Top finish
Top/edge detail
Base finish
Base trim finish

Optional Specifications

HP laminate
Additional grommet

Accessories

Power block

BOARDROOM TABLES

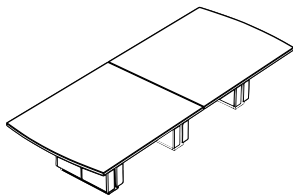

Boardroom Table - Bow End

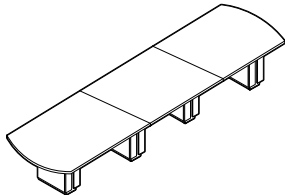

Boardroom Table - Bow End

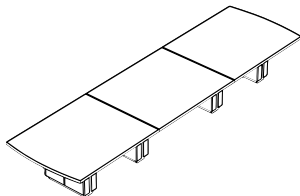

Boardroom Table - Bow End

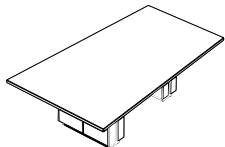

Boardroom Table - Wedge

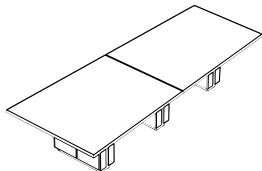

Boardroom Table - Wedge

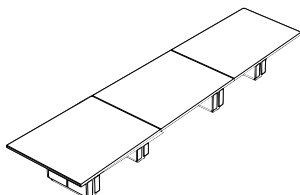

Boardroom Table - Wedge

MODEL#	DIMENSIONS D x W x H	FREIGHT CLASS	WT/LBS.	CUBIC FT.	1" TOP	1.5" TOP	GLAZE ADD	HP ADD
Z60120BW	60 x 120 x 29.5	250	602	242.5	N/A	\$6838	N/A	\$1389
Z60144BW	60 x 144 x 29.5	250	673	266.2	N/A	\$7320	N/A	\$1667
Z60168BW	60 x 168 x 29.5	250	753	290	N/A	\$7894	N/A	\$1945

Bow End Table includes THREE BASES with wire access doors on each side of base and wire concealment runners between bases. Shipped in 5 cartons.

Z48192BW	48 x 192 x 29.5	70	698	45.45	N/A	\$6704	N/A	\$1482
Z48216BW	48 x 216 x 29.5	70	758	48.95	N/A	\$7019	N/A	\$1667
Z48240BW	48 x 240 x 29.5	70	818	51.75	N/A	\$7463	N/A	\$1852
Z48264BW	48 x 264 x 29.5	70	872	54.55	N/A	\$7908	N/A	\$2038
Z48288BW	48 x 288 x 29.5	70	926	58.04	N/A	\$7908	N/A	\$2223

Bow End Table includes FOUR BASES with wire access doors on each side of base and wire concealment runners between bases. Shipped in 7 cartons.

Z60192BW	60 x 192 x 29.5	300	917.70	498.2	N/A	\$9931	N/A	\$2223
Z60216BW	60 x 216 x 29.5	300	988.05	531.4	N/A	\$10487	N/A	\$2500
Z60240BW	60 x 240 x 29.5	300	1073.10	1566.	N/A	\$10936	N/A	\$2778
Z60264BW	60 x 264 x 29.5	300	1143.45	1599.	N/A	\$11371	N/A	\$3056
Z60288BW	60 x 288 x 29.5	300	1213.80	1632.	N/A	\$12065	N/A	\$3334

Bow End Table includes FOUR BASES with wire access doors on each side of base and wire concealment runners between bases. Shipped in 7 cartons.

Z6096WE	60 x 96 x 29.5	150	398	78.59	N/A	\$4510	N/A	\$1112
---------	----------------	-----	-----	-------	-----	---------------	-----	---------------

Wedge Table includes TWO BASES with wire access doors on each side of base and wire concealment runners between bases. Wedge tapers from 60" w to 48" w. Shipped in 3 cartons.

Z60120WE	60 x 120 x 29.5	250	544.95	182.5	N/A	\$6838	N/A	\$1389
Z60144WE	60 x 144 x 29.5	250	603.75	197.5	N/A	\$7320	N/A	\$1667
Z60168WE	60 x 168 x 29.5	250	673.05	212.5	N/A	\$7894	N/A	\$1945

Wedge Table includes THREE BASES with wire access doors on each side of base and wire concealment runners between bases. Wedge tapers from 60" w to 48" w. Shipped in 5 cartons.

Z60192WE	60 x 192 x 29.5	300	824.25	445.8	N/A	\$9931	N/A	\$2223
Z60216WE	60 x 216 x 29.5	300	884.10	477.2	N/A	\$10487	N/A	\$2500
Z60240WE	60 x 240 x 29.5	300	948.15	510.4	N/A	\$10936	N/A	\$2778
Z60264WE	60 x 264 x 29.5	300	1006.95	1541.	N/A	\$11371	N/A	\$3056
Z60288WE	60 x 288 x 29.5	300	1065.75	1573.	N/A	\$12065	N/A	\$3334

Wedge Table includes FOUR BASES with wire access doors on each side of base and wire concealment runners between bases. Wedge tapers from 60" w to 48" w. Shipped in 7 cartons.

Required Specifications

Top finish
Top/edge detail
Base finish
Base trim finish

Optional Specifications

HP laminate
Additional grommet

Accessories

Power block

MEDIA TABLES

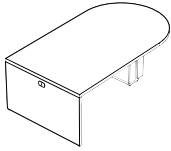

Media Table - D Island

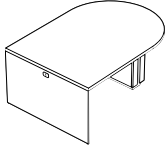

Media Table - D Island

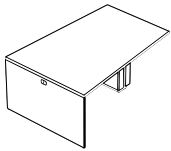

Media Table - D Wedge

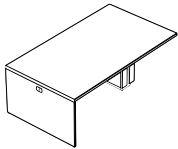

Media Table - Rectangular Island

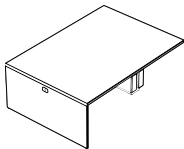

Media Table - Rectangular Island

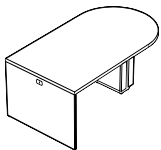

Media Table - D Island, 36" H

MODEL#	DIMENSIONS D x W x H	FREIGHT CLASS	WT/LBS.	CUBIC FT.	1" TOP	1.5" TOP	GLAZE ADD	HP ADD
Z4860DMIL	48 x 60 x 29.5	150	267	53.14	N/A	\$2811	N/A	\$556
Z4872DMIL	48 x 72 x 29.5	150	298.20	59.13	N/A	\$3014	N/A	\$667
Z4884DMIL	48 x 84 x 29.5	150	326.55	64.37	N/A	\$3209	N/A	\$778
Z4896DMIL	48 x 96 x 29.5	150	347.55	70.36	N/A	\$3399	N/A	\$889

D Media Island includes ONE BASE with wire access doors on each side of base and wire concealment runners between the base and the end panel. Grommet centered at the top of the end panel for wire pass through. Shipped in 3 cartons.

Z6060DMIL	60 x 60 x 29.5	150	323.93	69.61	N/A	\$3371	N/A	\$695
Z6072DMIL	60 x 72 x 29.5	150	359.10	77.10	N/A	\$3612	N/A	\$834
Z6084DMIL	60 x 84 x 29.5	150	397.95	83.83	N/A	\$3852	N/A	\$973
Z6096DMIL	60 x 96 x 29.5	150	433.65	91.32	N/A	\$4079	N/A	\$1112

D Media Island includes ONE BASE with wire access doors on each side of base and wire concealment runners between the base and the end panel. Grommet centered at the top of the end panel for wire pass through. Shipped in 3 cartons.

Z6060WMIL	60 x 60 x 29.5	150	306.60	62.13	N/A	\$3371	N/A	\$695
Z6072WMIL	60 x 72 x 29.5	150	338.10	68.86	N/A	\$3612	N/A	\$834
Z6084WMIL	60 x 84 x 29.5	150	374.85	76.35	N/A	\$3852	N/A	\$973
Z6096WMIL	60 x 96 x 29.5	150	407.40	83.83	N/A	\$4079	N/A	\$1112

Wedge Media Island includes ONE BASE with wire access doors on each side of base and wire concealment runners between the base and the end panel. Grommet centered at the top of the end panel for wire pass through. Wedge tapers from 60" w to 48" w. Shipped in 3 cartons.

Z4860RMIL	48 x 60 x 29.5	150	279.30	53.14	N/A	\$2588	N/A	\$556
Z4872RMIL	48 x 72 x 29.5	150	307.65	59.13	N/A	\$2774	N/A	\$667
Z4884RMIL	48 x 84 x 29.5	150	337.05	64.37	N/A	\$2950	N/A	\$778
Z4896RMIL	48 x 96 x 29.5	150	357	70.36	N/A	\$3121	N/A	\$889

Rectangular Media Island includes ONE BASE with wire access doors on each side of base and wire concealment runners between the base and the end panel. Grommet centered at the top of the end panel for wire pass through. Shipped in 3 cartons.

Z6060RMIL	60 x 60 x 29.5	150	339.15	69.61	N/A	\$3098	N/A	\$695
Z6072RMIL	60 x 72 x 29.5	150	373.80	76.95	N/A	\$3315	N/A	\$834
Z6084RMIL	60 x 84 x 29.5	150	414.75	83.83	N/A	\$3533	N/A	\$973
Z6096RMIL	60 x 96 x 29.5	150	449.40	91.32	N/A	\$3741	N/A	\$1112

Rectangular Media Island includes ONE BASE with wire access doors on each side of base and wire concealment runners between the base and the end panel. Grommet centered at the top of the end panel for wire pass through. Shipped in 3 cartons.

Z4860DMIM	48 x 60 x 36	150	291.90	57.63	N/A	\$3075	N/A	\$556
Z4872DMIM	48 x 72 x 36	150	321.30	63.62	N/A	\$3278	N/A	\$667
Z4884DMIM	48 x 84 x 36	150	349.65	68.86	N/A	\$3468	N/A	\$778
Z4896DMIM	48 x 96 x 36	150	370.65	74.85	N/A	\$3663	N/A	\$889

D Media Island includes ONE BASE with wire access doors on each side of base and wire concealment runners between the base and the end panel. Grommet centered at the top of the end panel for wire pass through. Shipped in 3 cartons.

Required Specifications

Top finish
Top/edge detail
Base finish
Base trim finish

Optional Specifications

HP laminate
Additional grommet

Accessories

Power block

MEDIA TABLES

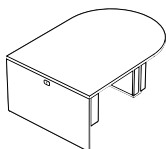

Media Table - D Island, 36" H

MODEL#	DIMENSIONS D x W x H	FREIGHT CLASS	WT/LBS.	CUBIC FT.	1" TOP	1.5" TOP	GLAZE ADD	HP ADD
Z6060DMIM	60 x 60 x 36	150	352.28	76.35	N/A	\$3635	N/A	\$695
Z6072DMIM	60 x 72 x 36	150	386.40	83.08	N/A	\$3871	N/A	\$834
Z6084DMIM	60 x 84 x 36	150	426.30	90.57	N/A	\$4112	N/A	\$973
Z6096DMIM	60 x 96 x 36	150	462	98.05	N/A	\$4338	N/A	\$1112

D Media Island includes ONE BASE with wire access doors on each side of base and wire concealment runners between the base and the end panel. Grommet centered at the top of the end panel for wire pass through. Shipped in 3 cartons.

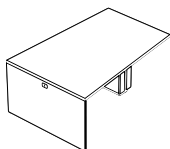

Media Table - D Wedge, 36" H

Z6060WMIM	60 x 60 x 36	150	331.80	66.62	N/A	\$3635	N/A	\$695
Z6072WMIM	60 x 72 x 36	150	364.35	74.10	N/A	\$3871	N/A	\$834
Z6084WMIM	60 x 84 x 36	150	424.20	80.84	N/A	\$4112	N/A	\$973
Z6096WMIM	60 x 96 x 36	150	424.20	80.84	N/A	\$4338	N/A	\$1112

Wedge Media Island includes ONE BASE with wire access doors on each side of base and wire concealment runners between the base and the end panel. Grommet centered at the top of the end panel for wire pass through. Wedge tapers from 60" w to 48" w. Shipped in 3 cartons.

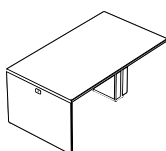

Media Table - Rectangular Island, 36" H

Z4860RMIM	48 x 60 x 36	150	301.35	57.63	N/A	\$2825	N/A	\$556
Z4872RMIM	48 x 72 x 36	150	330.75	63.62	N/A	\$3010	N/A	\$667
Z4884RMIM	48 x 84 x 36	150	360.15	68.86	N/A	\$3186	N/A	\$778
Z4896RMIM	48 x 96 x 36	150	380.10	74.85	N/A	\$3362	N/A	\$889

Rectangular Media Island includes ONE BASE with wire access doors on each side of base and wire concealment runners between the base and the end panel. Grommet centered at the top of the end panel for wire pass through. Shipped in 3 cartons.

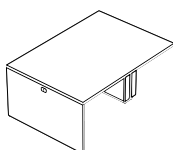

Media Table - Rectangular Island, 36" H

Z6060RMIM	60 x 60 x 36	150	367.50	76.35	N/A	\$3334	N/A	\$695
Z6072RMIM	60 x 72 x 36	150	402.15	83.08	N/A	\$3547	N/A	\$834
Z6084RMIM	60 x 84 x 36	150	442.05	90.57	N/A	\$3769	N/A	\$973
Z6096RMIM	60 x 96 x 36	150	477.75	98.05	N/A	\$3977	N/A	\$1112

Rectangular Media Island includes ONE BASE with wire access doors on each side of base and wire concealment runners between the base and the end panel. Grommet centered at the top of the end panel for wire pass through. Shipped in 3 cartons.

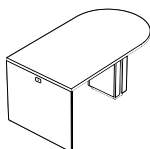

Media Table - D Island, 42" H

Z4860DMIH	48 x 60 x 42	150	312.90	62.13	N/A	\$3269	N/A	\$556
Z4872DMIH	48 x 72 x 42	150	342.30	68.11	N/A	\$3473	N/A	\$667
Z4884DMIH	48 x 84 x 42	150	371.70	73.35	N/A	\$3667	N/A	\$778
Z4896DMIH	48 x 96 x 42	150	391.65	79.34	N/A	\$3857	N/A	\$889

D Media Island includes ONE BASE with wire access doors on each side of base and wire concealment runners between the base and the end panel. Grommet centered at the top of the end panel for wire pass through. Shipped in 3 cartons.

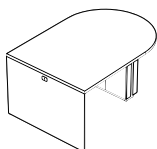

Media Table - D Island, 42" H

Z6060DMIH	60 x 60 x 42	150	378	82.34	N/A	\$3829	N/A	\$695
Z6072DMIH	60 x 72 x 42	150	413.70	89.82	N/A	\$4065	N/A	\$834
Z6084DMIH	60 x 84 x 42	150	453.60	97.31	N/A	\$4311	N/A	\$973
Z6096DMIH	60 x 96 x 42	150	488.25	104.7	N/A	\$4533	N/A	\$1112

D Media Island includes ONE BASE with wire access doors on each side of base and wire concealment runners between the base and the end panel. Grommet centered at the top of the end panel for wire pass through. Shipped in 3 cartons.

Required Specifications

Top finish
Top/edge detail
Base finish
Base trim finish

Optional Specifications

HP laminate
Additional grommet

Accessories

Power block

MEDIA TABLES

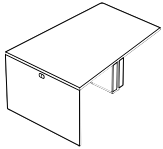

Media Table - Wedge, 42" H

MODEL#	DIMENSIONS D x W x H	FREIGHT CLASS	WT/LBS.	CUBIC FT.	1" TOP	1.5" TOP	GLAZE ADD	HP ADD
Z6060WMIH	60 x 60 x 42	150	355	71.86	N/A	\$3829	N/A	\$695
Z6072WMIH	60 x 72 x 42	150	387	78.59	N/A	\$4065	N/A	\$834
Z6084WMIH	60 x 84 x 42	150	424	86.08	N/A	\$4311	N/A	\$973
Z6096WMIH	60 x 96 x 42	150	457	93.56	N/A	\$4533	N/A	\$1112

Wedge Media Island includes ONE BASE with wire access doors on each side of base and wire concealment runners between the base and the end panel. Grommet centered at the top of the end panel for wire pass through. Wedge tapers from 60" w to 48" w. Shipped in 3 cartons.

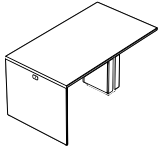

Media Table - Rectangular Island, 42" H

Z4860RMIH	48 x 60 x 42	150	324	62.13	N/A	\$3005	N/A	\$556
Z4872RMIH	48 x 72 x 42	150	353	68.11	N/A	\$3190	N/A	\$667
Z4884RMIH	48 x 84 x 42	150	382	73.35	N/A	\$3366	N/A	\$778
Z4896RMIH	48 x 96 x 42	150	402	79.34	N/A	\$3538	N/A	\$889

Rectangular Media Island includes ONE BASE with wire access doors on each side of base and wire concealment runners between the base and the end panel. Grommet centered at the top of the end panel for wire pass through. Shipped in 3 cartons.

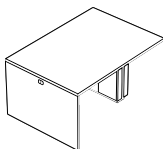

Media Table - Rectangular Island, 42" H

Z6060RMIH	60 x 60 x 42	150	394	82.34	N/A	\$3514	N/A	\$695
Z6072RMIH	60 x 72 x 42	150	429	89.82	N/A	\$3727	N/A	\$834
Z6084RMIH	60 x 84 x 42	150	469	97.31	N/A	\$3950	N/A	\$973
Z6096RMIH	60 x 96 x 42	150	504	104.7	N/A	\$4153	N/A	\$1112

Rectangular Media Island includes ONE BASE with wire access doors on each side of base and wire concealment runners between the base and the end panel. Grommet centered at the top of the end panel for wire pass through. Shipped in 3 cartons.

COLLABORATIVE TABLES

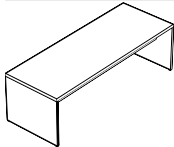

Collaborative Table - 29" H

Z367229BT	36 x 72 x 29.5	125	237	38.92	N/A	\$1389	N/A	\$500
Z368429BT	36 x 84 x 29.5	125	237	38.92	N/A	\$1616	N/A	\$584
Z369629BT	36 x 96 x 29.5	150	289	49.40	N/A	\$1750	N/A	\$667

Collaborative table with full end panels. Wire management runners span the length of the table between end panels. Shipped in 3 cartons.

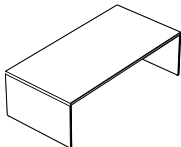

Collaborative Table - 29" H

Z487229BT	48 x 72 x 29.5	125	302	41.92	N/A	\$1746	N/A	\$667
Z488429BT	48 x 84 x 29.5	125	335	47.16	N/A	\$1880	N/A	\$778
Z489629BT	48 x 96 x 29.5	125	360	52.40	N/A	\$2033	N/A	\$889

Collaborative table with full end panels. Wire management runners span the length of the table between end panels. Shipped in 3 cartons.

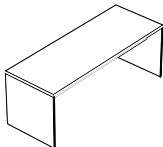

Collaborative Table - 36" H

Z367236BT	36 x 72 x 36	125	249	39.67	N/A	\$1440	N/A	\$500
Z368436BT	36 x 84 x 36	125	275	44.91	N/A	\$1672	N/A	\$584
Z369636BT	36 x 96 x 36	125	301	50.15	N/A	\$1806	N/A	\$667

Collaborative table with full end panels. Wire management runners span the length of the table between end panels. Shipped in 3 cartons.

Required Specifications

Top finish
Top/edge detail
Base finish
Base trim finish

Optional Specifications

HP laminate
Additional grommet

Accessories

Power block

COLLABORATIVE TABLES

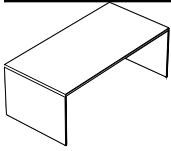

Collaborative Table - 36" H

MODEL#	DIMENSIONS D x W x H	FREIGHT CLASS	WT/LBS.	CUBIC FT.	1" TOP	1.5" TOP	GLAZE ADD	HP ADD
Z487236BT	48 x 72 x 36	125	319	43.41	N/A	\$1811	N/A	\$667
Z488436BT	48 x 84 x 36	125	351	48.65	N/A	\$1950	N/A	\$778
Z489636BT	48 x 96 x 36	125	376	53.89	N/A	\$2102	N/A	\$889

Collaborative table with full end panels. Wire management runners span the length of the table between end panels. Shipped in 3 cartons.

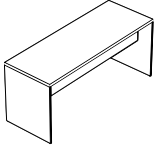

Collaborative Table - 42" H

Z367242BT	36 x 72 x 42	125	283	42.66	N/A	\$1612	N/A	\$500
Z368442BT	36 x 84 x 42	125	312	47.90	N/A	\$1862	N/A	\$584
Z369642BT	36 x 96 x 42	125	342	53.89	N/A	\$2014	N/A	\$667

Collaborative table with full end panels. Wire management runners span the length of the table between end panels. Shipped in 3 cartons.

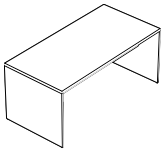

Collaborative Table - 42" H

Z487242BT	48 x 72 x 42	125	356	46.41	N/A	\$1996	N/A	\$667
Z488442BT	48 x 84 x 42	125	392	52.40	N/A	\$2149	N/A	\$778
Z489642BT	48 x 96 x 42	125	421	57.63	N/A	\$2325	N/A	\$889

Collaborative table with full end panels. Wire management runners span the length of the table between end panels. Shipped in 3 cartons.

AUDIOVISUAL

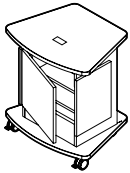

Multimedia Cart*

Z2822MCE	22.25 x 28 x 29.5-30	125	86	13.50	\$656	\$706	N/A	\$129
----------	----------------------	-----	----	-------	--------------	--------------	-----	--------------

Multimedia cart features one non-locking hinged door on the back. Includes 3 fixed shelves, 1 grommet on top and 1 grommet in bottom panel for wire pass thru. 4 locking casters included.

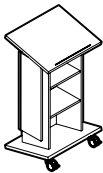

Lectern*

Z2444LEC	18 x 24 x 44-44.5	150	100	17	\$637	\$676	N/A	\$129
----------	-------------------	-----	-----	----	--------------	--------------	-----	--------------

Features angled stand and storage with 2 fixed shelves. 2 locking casters included.

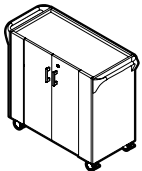

Serving Cart with Doors**

Z361836KD	18 x 36 x 36	125	150	20	\$1335	N/A	\$320	N/A
Z361829KD	18 x 36 x 29	125	113	16	\$1130	N/A	\$268	N/A

Cart features 2 doors with lock and 1 fixed height adjustable shelf. Top is recessed within side and end panels to act as a tray. Unique push handles are standard on both sides of the cart. 4 locking casters included.

Required Specifications

Top finish Push bar finish**
 Base finish Handles
 Top/edge detail*
 Base trim finish (not Z3618xxKD)

Optional Specifications

HP laminate
 Glazed door (only Z3618xxKD)

ACCESSORIES

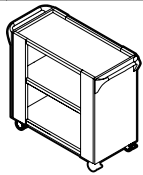

Serving Cart*

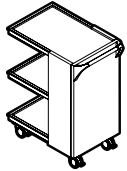

Buffet Cart*

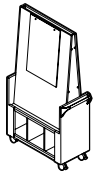

Visual Board*

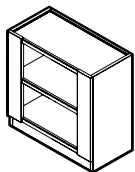

Buffet

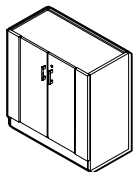

Buffet with Doors**

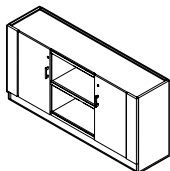

Buffet with Doors**

MODEL#	DIMENSIONS D x W x H	FREIGHT CLASS	WT/LBS.	CUBIC FT.	1" TOP	1.5" TOP	GLAZE ADD	HP ADD
Z361836KO	18 x 36 x 36	125	121	20	\$1448	N/A	N/A	N/A
Z361829KO	18 x 36 x 29	125	108	16	\$1211	N/A	N/A	N/A

Cart features 1 fixed height adjustable shelf. Top is recessed within side and end panels to act as a tray. Decorative aluminum trim is standard on the lip of each shelf. Unique push handles are standard on both sides of the cart. 4 locking casters included.

Z261836BK	18 x 26 x 36	150	79	15	\$1377	N/A	N/A	\$129
-----------	--------------	-----	----	----	---------------	-----	-----	--------------

Cart features 1 fixed shelf. Top is recessed within side and end panels to act as a tray. Unique push handles are standard. Decorative aluminum trim is standard on the lip of each shelf. Locking casters included. Height aligns with 36" buffets.

Z361872VB	18 x 36 x 72	250	187	38.50	\$2094	N/A	N/A	N/A
-----------	--------------	-----	-----	-------	---------------	-----	-----	-----

Angled visual board with paper pad on one side and dry erase board on the opposite side. Unique push handles are standard. Locking casters included. Decorative aluminum trim is standard on the lip of each shelf. Height aligns with 36" buffets. Shipped RTA (ready to assemble).

- *Wallmounted Visual Boards are available in Desk Accessories section.*

Z481836BO	18 x 48 x 36	125	152.50	22.50	\$1273	N/A	N/A	\$171
Z481829BO	18 x 48 x 29	125	135	18	\$1175	N/A	N/A	\$171
Z361836BO	18 x 36 x 36	125	126	18	\$1050	N/A	N/A	\$129
Z361829BO	18 x 36 x 29	100	112	14	\$966	N/A	N/A	\$129

Buffet features 1 fixed height adjustable shelf. Top is recessed within side and end panels to act as a tray. Decorative aluminum trim is standard on the lip of each shelf.

Z481836BD	18 x 48 x 36	125	171	22.50	\$1326	N/A	\$280	\$171
Z481829BD	18 x 48 x 29	100	148	18	\$1184	N/A	\$321	\$171
Z361836BD	18 x 36 x 36	125	138.50	18	\$1178	N/A	\$320	\$129
Z361829BD	18 x 36 x 29	100	119	14	\$991	N/A	\$268	\$129

Buffet features 2 doors with lock and 1 fixed height adjustable shelf. Top is recessed within side and end panels to act as a tray.

Z721836BU	18 x 72 x 36	125	242	33.50	\$1962	N/A	\$387	\$257
Z721829BU	18 x 72 x 29	125	211	27	\$1773	N/A	\$320	\$320
Z601836BU	18 x 60 x 36	125	188	28	\$1762	N/A	\$320	\$214
Z601829BU	18 x 60 x 29	125	163	22.50	\$1614	N/A	\$268	\$214

Buffet features 3 separate compartments. The two outer compartments come standard with locking doors and each features 1 fixed height adjustable shelf. The center compartment is open with 1 fixed height adjustable shelf. Decorative aluminum trim is standard on the lip of the open shelf. Top is recessed within side and end panels to act as a tray.

Required Specifications

Top finish Push bar finish*
Base finish
Handles
Aluminum trim finish (only ZxxxxBO/BU)

Optional Specifications

HP laminate
Glazed door**

Interconnecting Cables - Common Cable Lengths (in inches)

Female/Female				Female/Male			
42FF-21	\$80	42FF-76	\$131	42FM-12	\$76	42FM-106	\$163
42FF-29	\$88	42FF-79	\$134	42FM-21	\$85	42FM-115	\$172
42FF-32	\$90	42FF-82	\$137	42FM-32	\$95	42FM-118	\$175
42FF-37	\$95	42FF-85	\$139	42FM-46	\$108		
42FF-41	\$99	42FF-88	\$142	42FM-55	\$116		
42FF-46	\$103	42FF-91	\$145	42FM-58	\$119		
42FF-52	\$109	42FF-94	\$148	42FM-67	\$127		
42FF-55	\$112	42FF-100	\$153	42FM-70	\$130		
42FF-58	\$114	42FF-103	\$156	42FM-79	\$138		
42FF-61	\$117	42FF-106	\$158	42FM-82	\$141		
42FF-64	\$120	42FF-112	\$164	42FM-91	\$150		
42FF-67	\$123	42FF-115	\$167	42FM-94	\$151		
42FF-70	\$125	42FF-118	\$170	42FM-103	\$161		

OASIS MINI A & B CABLE LENGTHS NEEDED FOR DAISY-CHAINING

Model #	Oasis Mini A & Oasis Mini B	Oasis Mini A & Oasis Mini B	Oasis Mini A	Oasis Mini A	Oasis Mini B	Oasis Mini B
Cutout Positions	M1 & M3	M1 & M3	M1, M2 & M3	M1, M2 & M3	M1, M2 & M3	M1, M2 & M3
Infeed Position	Left or Right	Center	Left or Right	Center	Left or Right	Center
Reference	Drawing 1A/1B	Drawing 2A/2B	Drawing 3	Drawing 4	Drawing 5	Drawing 6
8' Zira Tables	(1) 42FF-37 SPECIFY INFEED	(1) 42FF-21 (1) 42FM-21 (1) DAISY-T SPECIFY INFEED	N/A	N/A	N/A	N/A
10' Zira Tables	(1) 42FF-61 SPECIFY INFEED	(1) 42FF-32 (1) 42FM-32 (1) DAISY-T SPECIFY INFEED	(3) 42FF-29 SPECIFY INFEED	(3) 42FF-29 SPECIFY INFEED	(2) 42FF-29 SPECIFY INFEED	(2) 42FF-29 (1) 42FM-12 (1) DAISY-T SPECIFY INFEED
12' Zira Tables	(1) 42FF-85 SPECIFY INFEED	(1) 42FF-46 (1) 42FM-46 (1) DAISY-T SPECIFY INFEED	(3) 42FF-41 SPECIFY INFEED	(3) 42FF-41 SPECIFY INFEED	(2) 42FF-41 SPECIFY INFEED	(2) 42FF-41 (1) 42FM-12 (1) DAISY-T SPECIFY INFEED
14' Zira Tables	(1) 42FF-55 (1) 42FM-55 SPECIFY INFEED	(1) 42FF-58 (1) 42FM-58 (1) DAISY-T SPECIFY INFEED	(3) 42FF-52 SPECIFY INFEED	(3) 42FF-52 SPECIFY INFEED	(2) 42FF-52 SPECIFY INFEED	(2) 42FF-52 (1) 42FM-12 (1) DAISY-T SPECIFY INFEED
16' Zira Tables	(1) 42FF-67 (1) 42FM-67 SPECIFY INFEED	(1) 42FF-70 (1) 42FM-70 (1) DAISY-T SPECIFY INFEED	(3) 42FF-64 SPECIFY INFEED	(3) 42FF-64 SPECIFY INFEED	(2) 42FF-64 SPECIFY INFEED	(2) 42FF-64 (1) 42FM-12 (1) DAISY-T SPECIFY INFEED
18' Zira Tables	(1) 42FF-79 (1) 42FM-79 SPECIFY INFEED	(1) 42FF-82 (1) 42FM-82 (1) DAISY-T SPECIFY INFEED	(3) 42FF-76 SPECIFY INFEED	(3) 42FF-76 SPECIFY INFEED	(2) 42FF-76 SPECIFY INFEED	(2) 42FF-76 (1) 42FM-12 (1) DAISY-T SPECIFY INFEED
20' Zira Tables	(1) 42FF-91 (1) 42FM-91 SPECIFY INFEED	(1) 42FF-94 (1) 42FM-94 (1) DAISY-T SPECIFY INFEED	(3) 42FF-88 SPECIFY INFEED	(3) 42FF-88 SPECIFY INFEED	(2) 42FF-88 SPECIFY INFEED	(2) 42FF-88 (1) 42FM-12 (1) DAISY-T SPECIFY INFEED
22' Zira Tables	(1) 42FF-103 (1) 42FM-103 SPECIFY INFEED	(1) 42FF-106 (1) 42FM-106 (1) DAISY-T SPECIFY INFEED	(3) 42FF-100 SPECIFY INFEED	(3) 42FF-100 SPECIFY INFEED	(2) 42FF-100 SPECIFY INFEED	(2) 42FF-100 (1) 42FM-12 (1) DAISY-T SPECIFY INFEED
24' Zira Tables	(1) 42FF-115 (1) 42FM-115 SPECIFY INFEED	(1) 42FF-118 (1) 42FM-118 (1) DAISY-T SPECIFY INFEED	(3) 42FF-112 SPECIFY INFEED	(3) 42FF-112 SPECIFY INFEED	(2) 42FF-112 SPECIFY INFEED	(2) 42FF-112 (1) 42FM-12 (1) DAISY-T SPECIFY INFEED

RECEPTION DESKS AND RETURNS

- Offered with **Straight** and **Bow** front
- Transactional tops available in 1" or 1 1/2" thick top with a variety of edge details
- Worksurface available in 1" thickness with A3 edge only

TOP AND BASE FINISHES

ACJ Absolute Acajou	ASN Asian Night
AWC Avant Cherry	AWH Avant Honey
BLK Black	BRC Brushed Cobalt
CSJ Constellation Java	DES Dark Espresso
HGT Hayden Grey	QTM Quartered Mahogany
SKC Shaker Cherry	SOG Storm Grey
TFW Tiger Fruitwood	TMA Tiger Mahogany
TMP Tiger Maple	TWL Tiger Walnut
WHT White	WHC White Chocolate*
WGY Willow Grey	WCR Winter Cherry

*textured, HP non-textured, top only

Reception Desks:

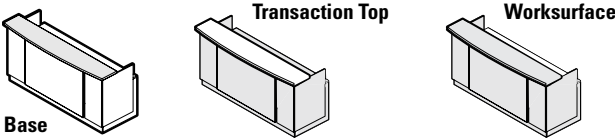

Reception Returns:

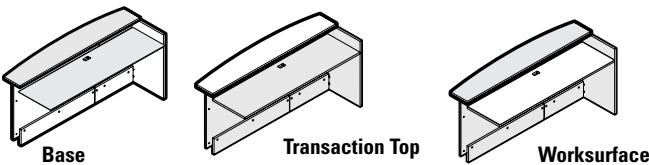

TRANSACTION TOP THICKNESS/EDGE DETAIL

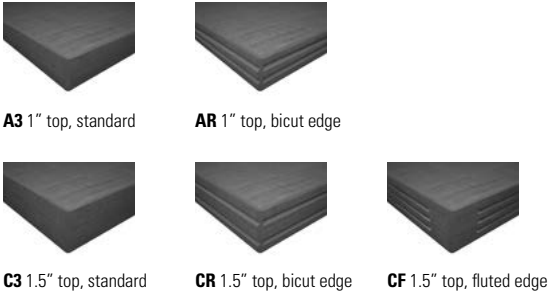

GLAZING (Center Panels)

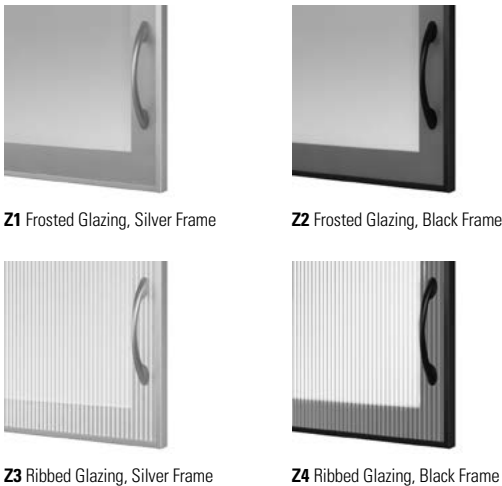

GROMMETS

- Two grommets are standard in position **AG1** and **AG3**
- Standard grommets can be removed at an upcharge
- Optional grommets available in **AG2**

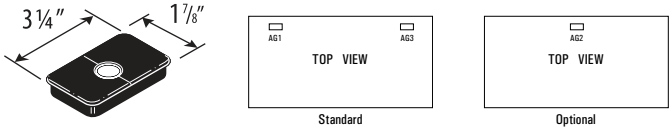

- Grommet hole dimensions are 3 1/4" wide x 1 7/8" deep.

POWER BLOCK

- A Power Block (model **PMSPDM**) may be ordered on transaction tops.
- A Power Block is a rectangular worksurface power/data module with one electrical duplex receptacle and two data (RJ45) receptacles. 9 foot black cord included. Power Block dimensions are 3 1/2" deep x 6 1/2" wide x 2 3/4" high.
- To purchase a Power Block, you must specify both the Power Block cut-out location and the Power Block model #. Order Power Block as **PMSPDM**, Add **\$238**. Power Blocks are available in standard worksurface locations (left, center or right). Order as **E1, E2 or E3**. ADD **\$65**.



TASK LIGHT

- Illuminates worksurface and optional glazed center panel
- Specify LED task light separately. Use PLED50 for 60", 66" and 72" wide reception units. Use PLED50 or PLED100 for 84" and 96" wide units. See page 536 for details.

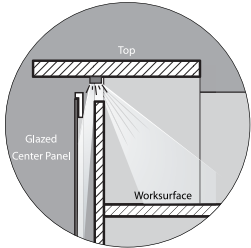

RECEPTION RETURNS - PIGEON

- Available in all laminates
- Worksurface available in 1" thickness with A3 edge only
- Collator shelves offered in Black (BLK) or Brushed Cobalt (BRC)
- One grommet is standard in position **AG3**
- Standard grommet can be removed at an upcharge
- Optional grommet available in position **AG2**, see upcharges above
- Power blocks are available in positions **E2 and E3**

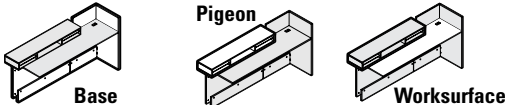

RECEPTION RETURNS - BOOKCASE

- Available in all laminates listed above
- Worksurface available in 1" thickness with A3 edge only
- One grommet is standard in position **AG2**
- Standard grommet can be removed at an upcharge
- Optional grommet available in position **AG3** for **54", 60" and 72" wide units only**
- Power blocks are available in positions **E2 and E3** for **54", 60" and 72" wide units only**

RECEPTION DESKS

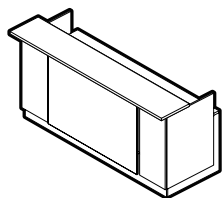

Reception Desk

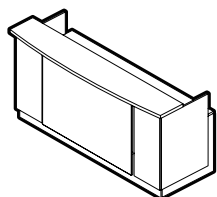

Reception Desk - Bow Front

MODEL#	DIMENSIONS D x W x H	FREIGHT CLASS	WT/LBS.	CUBIC FT.	1" TOP	1.5" TOP	GLAZE ADD	HP ADD
Z3096RDS	35.5 x 96 x 42.3-42.8	70	385	23.23	\$2537	\$2677	\$529	\$599
Z3084RDS	35.5 x 89.4 x 42.3-42.8	70	351	20.48	\$2256	\$2382	\$456	\$524
Z3072RDS	35.5 x 77.4 x 42.3-42.8	70	315	17.99	\$2080	\$2187	\$382	\$449
Z3066RDS	35.5 x 71.4 x 42.3-42.8	70	298	16.98	\$1974	\$2078	\$345	\$412
Z3060RDS	35.5 x 65.4 x 42.3-42.8	70	280	15.48	\$1883	\$1979	\$308	\$374
Z2496RDS	30 x 96 x 42.3-42.8	70	353	21.98	\$2394	\$2534	\$529	\$513
Z2484RDS	30 x 89.4 x 42.3-42.8	70	320	19.49	\$2133	\$2259	\$456	\$449
Z2472RDS	30 x 77.4 x 42.3-42.8	70	287	16.98	\$1963	\$2074	\$382	\$385
Z2466RDS	30 x 71.4 x 42.3-42.8	70	272	15.99	\$1860	\$1964	\$345	\$353
Z2460RDS	30 x 65.4 x 42.3-42.8	70	256	15	\$1772	\$1868	\$308	\$321

Z24xxRDS units are **not freestanding**. Z30xxRDS units can be specified as freestanding. Shipped RTA (ready to assemble) in 3 cartons. Standard with two grommets. Accommodates shells of all depths. Widths and depths listed are outside dimensions including transaction top overhang on the front and sides, with the exception of 96" wide units. 96" wide units are 89" wide. Model numbers reflect the primary worksurface dimensions.

Z3096RDB	35.5 x 101.4 x 42.3-42.8	70	382	23.23	\$2537	\$2677	\$529	\$599
Z3084RDB	35.5 x 89.4 x 42.3-42.8	70	348	20.48	\$2256	\$2382	\$456	\$524
Z3072RDB	35.5 x 77.4 x 42.3-42.8	70	312	17.99	\$2080	\$2187	\$382	\$449
Z3066RDB	35.5 x 71.4 x 42.3-42.8	70	295	16.98	\$1974	\$2078	\$345	\$412
Z3060RDB	35.5 x 65.4 x 42.3-42.8	70	277	15.99	\$1883	\$1979	\$308	\$374
Z2496RDB	30 x 101.4 x 42.3-42.8	70	350	21.98	\$2394	\$2520	\$529	\$513
Z2484RDB	30 x 89.4 x 42.3-42.8	70	317	19.49	\$2133	\$2259	\$456	\$449
Z2472RDB	30 x 77.4 x 42.3-42.8	70	284	16.98	\$1963	\$2074	\$382	\$385
Z2466RDB	30 x 71.4 x 42.3-42.8	70	269	15.99	\$1860	\$1964	\$345	\$353
Z2460RDB	30 x 65.4 x 42.3-42.8	70	253	15	\$1772	\$1868	\$308	\$321

Z24xxRDB units are **not freestanding**. Z30xxRDB units can be specified as freestanding. Shipped RTA (ready to assemble) in 3 cartons. Standard with two grommets. Accommodates shells of all depths. Widths and depths listed are outside dimensions including transaction top overhang on the front and sides, with the exception of 96" wide units. 96" wide units are 89" wide. Model numbers reflect the primary worksurface dimensions.

Required Specifications

Top finish
Top/edge detail
Base/surround finish
Transaction top finish

Optional Specifications

HP laminate
Additional grommet

Accessories

Power block

HIGH RECEPTION RETURNS

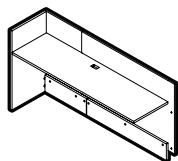

High Reception Return - LEFT

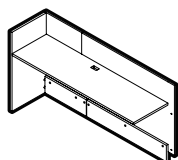

High Reception Return - LEFT

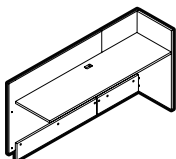

High Reception Return - RIGHT

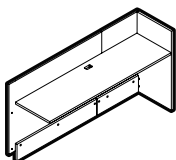

High Reception Return - RIGHT

MODEL#	DIMENSIONS	FREIGHT CLASS	WT/LBS.	CUBIC FT.	1" TOP	1.5" TOP	GLAZE ADD	HP ADD
D x W x H								
Z2472HRRL	25 x 75.7 x 39.3-39.8	70	151	8.20	\$947	N/A	N/A	\$257
Z2460HRRL	25 x 63.7 x 39.3-39.8	70	131.20	7	\$829	N/A	N/A	\$214
Z2454HRRL	25 x 57.7 x 39.3-39.8	70	120.90	5.75	\$752	N/A	N/A	\$193
Z2448HRRL	25 x 51.7 x 39.3-39.8	70	110.90	5.25	\$698	N/A	N/A	\$171
Z2442HRRL	25 x 45.7 x 39.3-39.8	70	100.80	4.80	\$643	N/A	N/A	\$150
Z2436HRRL	25 x 39.7 x 39.3-39.8	70	90.70	4.30	\$588	N/A	N/A	\$129

Not freestanding. Grommet in worksurface. Shipped RTA (ready to assemble). Accommodates shells of all depths. Connecting hardware included. Widths and depths listed are outside dimensions including outside surrounds. Model numbers reflect the primary worksurface dimensions.

Z2072HRRL	20.9 x 75.7 x 39.3-39.8	70	139	8.20	\$836	N/A	N/A	\$214
Z2060HRRL	20.9 x 63.7 x 39.3-39.8	70	121	7	\$729	N/A	N/A	\$179
Z2054HRRL	20.9 x 57.7 x 39.3-39.8	70	111	5.75	\$657	N/A	N/A	\$161
Z2048HRRL	20.9 x 51.7 x 39.3-39.8	70	102	5.25	\$610	N/A	N/A	\$143
Z2042HRRL	20.9 x 45.7 x 39.3-39.8	70	92	4.80	\$560	N/A	N/A	\$125
Z2036HRRL	20.9 x 39.7 x 39.3-39.8	70	83	4.30	\$510	N/A	N/A	\$107

Not freestanding. Grommet in worksurface. Shipped RTA (ready to assemble). Accommodates shells of **20" depths**. Connecting hardware included. Widths and depths listed are outside dimensions including outside surrounds. Model numbers reflect the primary worksurface dimensions.

Z2472HRRR	25 x 75.7 x 39.8	70	151	8.20	\$947	N/A	N/A	\$257
Z2460HRRR	25 x 63.7 x 39.8	70	131.20	7	\$829	N/A	N/A	\$214
Z2454HRRR	25 x 57.7 x 39.8	70	120.90	5.75	\$752	N/A	N/A	\$193
Z2448HRRR	25 x 51.7 x 39.8	70	110.90	5.25	\$698	N/A	N/A	\$171
Z2442HRRR	25 x 45.7 x 39.8	70	100.80	4.80	\$643	N/A	N/A	\$150
Z2436HRRR	25 x 39.7 x 39.8	70	90.70	4.30	\$588	N/A	N/A	\$129

Not freestanding. Grommet in worksurface. Shipped RTA (ready to assemble). Accommodates shells of all depths. Connecting hardware included. Widths and depths listed are outside dimensions including outside surrounds. Model numbers reflect the primary worksurface dimensions.

Z2072HRRR	20.9 x 75.7 x 39.8	70	139	8.20	\$836	N/A	N/A	\$214
Z2060HRRR	20.9 x 63.7 x 39.8	70	121	7	\$729	N/A	N/A	\$179
Z2054HRRR	20.9 x 57.7 x 39.8	70	111	5.75	\$657	N/A	N/A	\$161
Z2048HRRR	20.9 x 51.7 x 39.8	70	102	5.25	\$610	N/A	N/A	\$143
Z2042HRRR	20.9 x 45.7 x 39.8	70	92	4.80	\$560	N/A	N/A	\$125
Z2036HRRR	20.9 x 39.7 x 39.8	70	83	4.30	\$510	N/A	N/A	\$107

Not freestanding. Grommet in worksurface. Shipped RTA (ready to assemble). Accommodates shells of **20" depths**. Connecting hardware included. Widths and depths listed are outside dimensions including outside surrounds. Model numbers reflect the primary worksurface dimensions.

Required Specifications

Top finish
Top/edge detail
Base/surround finish

Optional Specifications

HP laminate
Additional grommet

Accessories

Power block

LOW RECEPTION RETURNS

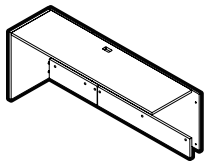

Low Reception Return - LEFT

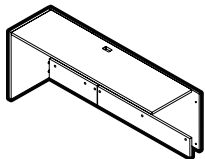

Low Reception Return - LEFT

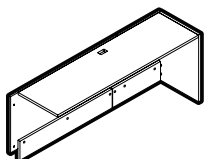

Low Reception Return - RIGHT

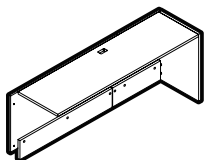

Low Reception Return - RIGHT

MODEL#	DIMENSIONS D x W x H	FREIGHT CLASS	WT/LBS.	CUBIC FT.	1" TOP	1.5" TOP	GLAZE ADD	HP ADD
Z2472LRRL	25 x 75.7 x 29	70	141	6.63	\$921	N/A	N/A	\$257
Z2460LRRL	25 x 63.7 x 29	70	122	5.61	\$795	N/A	N/A	\$214
Z2454LRRL	25 x 57.7 x 29	70	112.90	5.50	\$728	N/A	N/A	\$193
Z2448LRRL	25 x 51.7 x 29	70	103.40	5	\$675	N/A	N/A	\$171
Z2442LRRL	25 x 45.7 x 29	70	94	4.50	\$620	N/A	N/A	\$150
Z2436LRRL	25 x 39.7 x 29	70	84.30	4	\$565	N/A	N/A	\$129

Not freestanding. Grommet in worksurface. Shipped RTA (ready to assemble). Accommodates shells of all depths. Connecting hardware included. Widths and depths listed are outside dimensions including outside surrounds. Model numbers reflect the primary worksurface dimensions.

Z2072LRRL	20.9 x 75.7 x 29	70	128.80	6.63	\$810	N/A	N/A	\$214
Z2060LRRL	20.9 x 63.7 x 29	70	111.30	5.61	\$696	N/A	N/A	\$179
Z2054LRRL	20.9 x 57.7 x 29	70	102.80	5.50	\$635	N/A	N/A	\$161
Z2048LRRL	20.9 x 51.7 x 29	70	94.10	5	\$588	N/A	N/A	\$143
Z2042LRRL	20.9 x 45.7 x 29	70	85.30	4.50	\$539	N/A	N/A	\$125
Z2036LRRL	20.9 x 39.7 x 29	70	76.30	4	\$490	N/A	N/A	\$107

Not freestanding. Grommet in worksurface. Shipped RTA (ready to assemble). Accommodates shells of 20" depths. Connecting hardware included. Widths and depths listed are outside dimensions including outside surrounds. Model numbers reflect the primary worksurface dimensions.

Z2472LRRR	25 x 75.7 x 29	70	141	6.63	\$921	N/A	N/A	\$257
Z2460LRRR	25 x 63.7 x 29	70	122	5.61	\$795	N/A	N/A	\$214
Z2454LRRR	25 x 57.7 x 29	70	112.90	5.50	\$728	N/A	N/A	\$193
Z2448LRRR	25 x 51.7 x 29	70	103.40	5	\$675	N/A	N/A	\$171
Z2442LRRR	25 x 45.7 x 29	70	94	4.50	\$620	N/A	N/A	\$150
Z2436LRRR	25 x 39.7 x 29	70	84.30	4	\$565	N/A	N/A	\$129

Not freestanding. Grommet in worksurface. Shipped RTA (ready to assemble). Accommodates shells of all depths. Connecting hardware included. Widths and depths listed are outside dimensions including outside surrounds. Model numbers reflect the primary worksurface dimensions.

Z2072LRRR	20.9 x 75.7 x 28.6-29	70	128.80	6.75	\$810	N/A	N/A	\$214
Z2060LRRR	20.9 x 63.7 x 28.6-29	70	111.30	5.75	\$696	N/A	N/A	\$179
Z2054LRRR	20.9 x 57.7 x 28.6-29	70	102.80	5.50	\$635	N/A	N/A	\$161
Z2048LRRR	20.9 x 51.7 x 28.6-29	70	94.10	5	\$588	N/A	N/A	\$143
Z2042LRRR	20.9 x 45.7 x 28.6-29	70	85.30	4.50	\$539	N/A	N/A	\$125
Z2036LRRR	20.9 x 39.7 x 28.6-29	70	76.30	4	\$490	N/A	N/A	\$107

Not freestanding. Grommet in worksurface. Shipped RTA (ready to assemble). Accommodates shells of 20" depths. Connecting hardware included. Widths and depths listed are outside dimensions including outside surrounds. Model numbers reflect the primary worksurface dimensions.

Required Specifications

Top finish
Top/edge detail
Base/surround finish

Optional Specifications

HP laminate
Additional grommet

Accessories

Power block

TRANSACTIONAL RETURNS

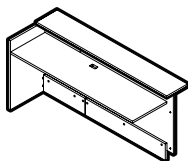

Transactional Return - LEFT

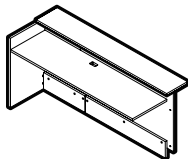

Transactional Return - LEFT

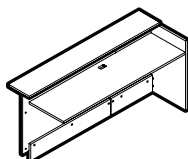

Transactional Return - RIGHT

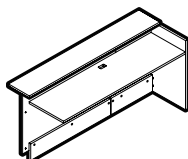

Transactional Return - RIGHT

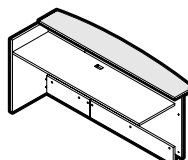

Transactional Return, Bow Front - LEFT

MODEL#	DIMENSIONS D x W x H	FREIGHT CLASS	WT/LBS.	CUBIC FT.	1" TOP	1.5" TOP	GLAZE ADD	HP ADD
Z2472TSRL	29.7 x 75.7 x 36.5-37	70	166	9.75	\$1129	\$1216	N/A	\$257
Z2460TSRL	29.7 x 63.7 x 36.5-37	70	144	8.75	\$973	\$1047	N/A	\$214
Z2454TSRL	29.7 x 57.7 x 36.5-37	70	132	7.50	\$884	\$952	N/A	\$193
Z2448TSRL	29.7 x 51.7 x 36.5-37	70	121	7	\$812	\$873	N/A	\$171
Z2442TSRL	29.7 x 45.7 x 36.5-37	70	109	6.25	\$745	\$800	N/A	\$150
Z2436TSRL	29.7 x 39.7 x 36.5-37	70	96	5.50	\$676	\$724	N/A	\$129

Not freestanding. Grommet in worksurface. Shipped RTA (ready to assemble). Accommodates shells of all depths. Connecting hardware included. Widths and depths listed are outside dimensions including transaction top overhang on the front and sides. Model numbers reflect the primary worksurface dimensions.

Z2072TSRL	25.6 x 75.7 x 36.5-37	70	153	8.25	\$1014	\$1101	N/A	\$214
Z2060TSRL	25.6 x 63.7 x 36.5-37	70	132	7.25	\$871	\$945	N/A	\$179
Z2054TSRL	25.6 x 57.7 x 36.5-37	70	120	6.25	\$788	\$856	N/A	\$161
Z2048TSRL	25.6 x 51.7 x 36.5-37	70	110	5.50	\$723	\$784	N/A	\$143
Z2042TSRL	25.6 x 45.7 x 36.5-37	70	100	5	\$659	\$714	N/A	\$125
Z2036TSRL	25.6 x 39.7 x 36.5-37	70	89	4.40	\$598	\$646	N/A	\$107

Not freestanding. Grommet in worksurface. Shipped RTA (ready to assemble). Accommodates shells of 20" depths. Connecting hardware included. Widths and depths listed are outside dimensions including transaction top overhang on the front and sides. Model numbers reflect the primary worksurface dimensions.

Z2472TSRR	29.7 x 75.7 x 36.5-37	70	166	9.75	\$1129	\$1216	N/A	\$257
Z2460TSRR	29.7 x 63.7 x 36.5-37	70	144	8.75	\$973	\$1047	N/A	\$214
Z2454TSRR	29.7 x 57.7 x 36.5-37	70	132	7.50	\$884	\$952	N/A	\$193
Z2448TSRR	29.7 x 51.7 x 36.5-37	70	121	7	\$812	\$873	N/A	\$171
Z2442TSRR	29.7 x 45.7 x 36.5-37	70	109	6.25	\$745	\$800	N/A	\$150
Z2436TSRR	29.7 x 39.7 x 36.5-37	70	96	5.50	\$676	\$724	N/A	\$129

Not freestanding. Grommet in worksurface. Shipped RTA (ready to assemble). Accommodates shells of all depths. Connecting hardware included. Widths and depths listed are outside dimensions including transaction top overhang on the front and sides. Model numbers reflect the primary worksurface dimensions.

Z2072TSRR	25.6 x 75.7 x 36.5-37	70	153	8.25	\$1014	\$1101	N/A	\$214
Z2060TSRR	25.6 x 63.7 x 36.5-37	70	132	7.25	\$871	\$945	N/A	\$179
Z2054TSRR	25.6 x 57.7 x 36.5-37	70	120	6.25	\$788	\$856	N/A	\$161
Z2048TSRR	25.6 x 51.7 x 36.5-37	70	110	5.50	\$723	\$784	N/A	\$143
Z2042TSRR	25.6 x 45.7 x 36.5-37	70	100	5	\$659	\$714	N/A	\$125
Z2036TSRR	25.6 x 39.7 x 36.5-37	70	89	4.40	\$598	\$646	N/A	\$107

Not freestanding. Grommet in worksurface. Shipped RTA (ready to assemble). Accommodates shells of 20" depths. Connecting hardware included. Widths and depths listed are outside dimensions including transaction top overhang on the front and sides. Model numbers reflect the primary worksurface dimensions.

Z2472TBRL	32.7 x 75.7 x 36.5-37	70	168.20	9.75	\$1129	\$1216	N/A	\$257
Z2460TBRL	32.7 x 63.7 x 36.5-37	70	145.30	8.50	\$973	\$1047	N/A	\$214
Z2454TBRL	32.7 x 57.7 x 36.5-37	70	134.40	7.50	\$884	\$952	N/A	\$193
Z2448TBRL	32.7 x 51.7 x 36.5-37	70	122.20	7	\$812	\$873	N/A	\$171
Z2442TBRL	32.7 x 45.7 x 36.5-37	70	110.90	6.25	\$745	\$800	N/A	\$150
Z2436TBRL	32.7 x 39.7 x 36.5-37	70	98.40	5.50	\$676	\$724	N/A	\$129

Not freestanding. Grommet in worksurface. Shipped RTA (ready to assemble). Accommodates shells of all depths. Connecting hardware included. Widths and depths listed are outside dimensions including transaction top overhang on the front and sides. Model numbers reflect the primary worksurface dimensions.

Required Specifications

Top finish
Base/surround finish
Transaction top finish

Optional Specifications

HP laminate
Additional grommet

Accessories

Power block

TRANSACTIONAL RETURNS

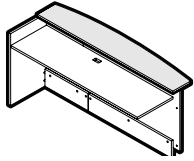

Transactional Return, Bow Front - LEFT

MODEL#	DIMENSIONS D x W x H	FREIGHT CLASS	WT/LBS.	CUBIC FT.	1" TOP	1.5" TOP	GLAZE ADD	HP ADD
Z2072TBRL	28.6 x 75.7 x 36.5-37	70	155.60	8.25	\$1014	\$1101	N/A	\$214
Z2060TBRL	28.6 x 63.7 x 36.5-37	70	134.20	7.50	\$871	\$945	N/A	\$179
Z2054TBRL	28.6 x 57.7 x 36.5-37	70	124	6.50	\$788	\$856	N/A	\$161
Z2048TBRL	28.6 x 51.7 x 36.5-37	70	112.60	6	\$723	\$784	N/A	\$143
Z2042TBRL	28.6 x 45.7 x 36.5-37	70	101.90	5.25	\$659	\$714	N/A	\$125
Z2036TBRL	28.6 x 39.7 x 36.5-37	70	90.10	4.70	\$598	\$646	N/A	\$107

Not freestanding. Grommet in worksurface. Shipped RTA (ready to assemble). Accommodates shells of **20" depths**. Connecting hardware included. Widths and depths listed are outside dimensions including transaction top overhang on the front and sides. Model numbers reflect the primary worksurface dimensions.

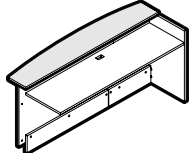

Transactional Return, Bow Front - RIGHT

Z2472TBRR	32.7 x 75.7 x 36.5-37	70	168.20	9.75	\$1129	\$1216	N/A	\$257
Z2460TBRR	32.7 x 63.7 x 36.5-37	70	145.30	8.50	\$973	\$1047	N/A	\$214
Z2454TBRR	32.7 x 57.7 x 36.5-37	70	134.40	7.50	\$884	\$952	N/A	\$193
Z2448TBRR	32.7 x 51.7 x 36.5-37	70	122.20	7	\$812	\$873	N/A	\$171
Z2442TBRR	32.7 x 45.7 x 36.5-37	70	110.90	6.25	\$745	\$800	N/A	\$150
Z2436TBRR	32.7 x 39.7 x 36.5-37	70	98.40	5.50	\$676	\$724	N/A	\$129

Not freestanding. Grommet in worksurface. Shipped RTA (ready to assemble). Accommodates shells of all depths. Connecting hardware included. Widths and depths listed are outside dimensions including transaction top overhang on the front and sides. Model numbers reflect the primary worksurface dimensions.

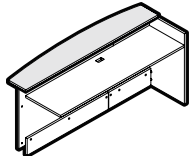

Transactional Return, Bow Front - RIGHT

Z2072TBRR	28.6 x 75.7 x 36.5-37	70	155.60	8.25	\$1014	\$1101	N/A	\$214
Z2060TBRR	28.6 x 63.7 x 36.5-37	70	134.20	7.50	\$871	\$945	N/A	\$179
Z2054TBRR	28.6 x 57.7 x 36.5-37	70	124	6.50	\$788	\$856	N/A	\$161
Z2048TBRR	28.6 x 51.7 x 36.5-37	70	112.60	6	\$723	\$784	N/A	\$143
Z2042TBRR	28.6 x 45.7 x 36.5-37	70	101.90	5.25	\$659	\$714	N/A	\$125
Z2036TBRR	28.6 x 39.7 x 36.5-37	70	90.10	4.70	\$598	\$646	N/A	\$107

Not freestanding. Grommet in worksurface. Shipped RTA (ready to assemble). Accommodates shells of **20" depths**. Connecting hardware included. Widths and depths listed are outside dimensions including transaction top overhang on the front and sides. Model numbers reflect the primary worksurface dimensions.

Required Specifications

Top finish
Transaction top finish
Base/surround finish

Optional Specifications

HP laminate
Additional grommet

Accessories

Power block

PIGEON RECEPTION RETURNS

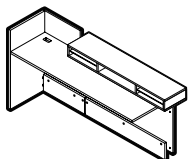

Pigeon Reception Return - LEFT*

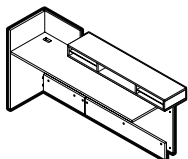

Pigeon Reception Return - LEFT*

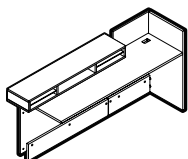

Pigeon Reception Return - RIGHT*

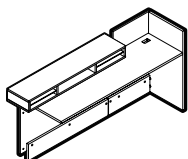

Pigeon Reception Return - RIGHT*

MODEL#	DIMENSIONS D x W x H	FREIGHT CLASS	WT/LBS.	CUBIC FT.	1" TOP	1.5" TOP	GLAZE ADD	HP ADD
Z2472PRRL	31 x 75.7 x 39.8	70	171.30	9.75	\$1278	N/A	N/A	\$257
Z2460PRRL	31 x 63.7 x 39.8	70	149	8.25	\$1123	N/A	N/A	\$214
Z2454PRRL	31 x 57.7 x 39.8	70	136.40	7.50	\$1044	N/A	N/A	\$193

Not freestanding. Grommet in worksurface. Shipped RTA (ready to assemble). Accommodates shells of all depths. Connecting hardware included. Widths and depths listed are outside dimensions including transaction top overhang on the front and sides. Model numbers reflect the primary worksurface dimensions.

Z2072PRRL	26.9 x 75.7 x 39.8	70	159	9.75	\$1167	N/A	N/A	\$214
Z2060PRRL	26.9 x 63.7 x 39.8	70	138.20	8.25	\$1023	N/A	N/A	\$179
Z2054PRRL	26.9 x 57.7 x 39.8	70	126.20	7.50	\$949	N/A	N/A	\$161

Not freestanding. Grommet in worksurface. Shipped RTA (ready to assemble). Accommodates shells of 20" depths. Connecting hardware included. Widths and depths listed are outside dimensions including transaction top overhang on the front and sides. Model numbers reflect the primary worksurface dimensions.

Z2472PRRR	31 x 75.7 x 39.8	70	171.30	9.75	\$1278	N/A	N/A	\$257
Z2460PRRR	31 x 63.7 x 39.8	70	149	8.25	\$1123	N/A	N/A	\$214
Z2454PRRR	31 x 57.7 x 39.8	70	136.40	7.50	\$1044	N/A	N/A	\$193

Not freestanding. Grommet in worksurface. Shipped RTA (ready to assemble). Accommodates shells of all depths. Connecting hardware included. Widths and depths listed are outside dimensions including transaction top overhang on the front and sides. Model numbers reflect the primary worksurface dimensions.

Z2072PRRR	26.9 x 75.7 x 39.8	70	159	9.75	\$1167	N/A	N/A	\$214
Z2060PRRR	26.9 x 63.7 x 39.8	70	138.20	8.25	\$1023	N/A	N/A	\$179
Z2054PRRR	26.9 x 57.7 x 39.8	70	126.20	7.50	\$949	N/A	N/A	\$161

Not freestanding. Grommet in worksurface. Shipped RTA (ready to assemble). Accommodates shells of 20" depths. Connecting hardware included. Widths and depths listed are outside dimensions including transaction top overhang on the front and sides. Model numbers reflect the primary worksurface dimensions.

Required Specifications

- Top finish
- Base/surround finish
- Pigeon hole finish
- Collator finish

Optional Specifications

- HP laminate
- Additional grommet

Accessories

- Power block

BOOKCASE RETURNS

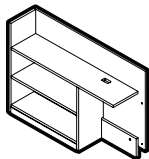

Bookcase Reception Return - LEFT

MODEL#	DIMENSIONS D x W x H	FREIGHT CLASS	WT/LBS.	CUBIC FT.	1" TOP	1.5" TOP	GLAZE ADD	HP ADD
Z1272BRRL	13.7 x 75.7 x 39.8	70	158	7.50	\$1022	N/A	N/A	\$129
Z1260BRRL	13.7 x 63.7 x 39.8	70	139	6.22	\$903	N/A	N/A	\$107

Not freestanding. Grommet in worksurface. Shipped RTA (ready to assemble). Accommodates shells of all depths. Connecting hardware included. Widths and depths listed are outside dimensions including outside surrounds. Model numbers reflect the primary worksurface dimensions.

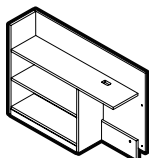

Bookcase Reception Return - LEFT

Z1254BRRL	13.7 x 57.7 x 39.8	65	131	5.69	\$836	N/A	N/A	\$97
Z1248BRRL	13.7 x 51.7 x 39.8	70	114	5.15	\$743	N/A	N/A	\$86
Z1242BRRL	13.7 x 45.7 x 39.8	65	106	4.62	\$699	N/A	N/A	\$75
Z1236BRRL	13.7 x 39.7 x 39.8	65	98	4.11	\$654	N/A	N/A	\$65

Not freestanding. Grommet in worksurface. Shipped RTA (ready to assemble). Accommodates shells of all depths. Connecting hardware included. Widths and depths listed are outside dimensions including outside surrounds. Model numbers reflect the primary worksurface dimensions.

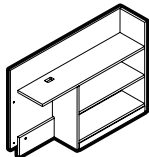

Bookcase Reception Return - RIGHT

Z1272BRRR	13.7 x 75.7 x 39.8	70	158	7.50	\$1022	N/A	N/A	\$129
Z1260BRRR	13.7 x 63.7 x 39.8	70	139	6.22	\$903	N/A	N/A	\$107

Not freestanding. Grommet in worksurface. Shipped RTA (ready to assemble). Accommodates shells of all depths. Connecting hardware included. Widths and depths listed are outside dimensions including outside surrounds. Model numbers reflect the primary worksurface dimensions.

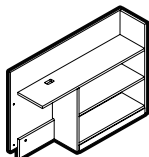

Bookcase Reception Return - RIGHT

Z1254BRRR	13.7 x 57.7 x 39.8	65	131	5.69	\$836	N/A	N/A	\$97
Z1248BRRR	13.7 x 51.7 x 39.8	70	114	5.15	\$743	N/A	N/A	\$86
Z1242BRRR	13.7 x 45.7 x 39.8	65	106	4.62	\$699	N/A	N/A	\$75
Z1236BRRR	13.7 x 39.7 x 39.8	65	98	4.11	\$654	N/A	N/A	\$65

Not freestanding. Grommet in worksurface. Shipped RTA (ready to assemble). Accommodates shells of all depths. Connecting hardware included. Widths and depths listed are outside dimensions including outside surrounds. Model numbers reflect the primary worksurface dimensions.

RECEPTION DESK VERTICAL STORAGE

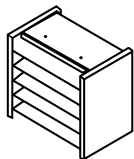

Reception Desk - Vertical Storage*

ZRDVS13	9.3 x 13.4 x 12.2	70	12	.80	\$166	N/A	N/A	N/A
---------	-------------------	----	----	-----	--------------	-----	-----	-----

Collator shelves.

Required Specifications

Top finish
Base/surround finish
Pigeon hole finish*
Collator finish*

Optional Specifications

HP laminate
Additional grommet

Accessories

Power block

desking – metal



StreamLINE II

306-337



Global's **StreamLINE** series incorporates a rich laminate top with a sturdy steel body. This unique combination is great for heavy duty environments such as offices, schools, warehouses and factories.

Full-to-Floor Pedestals were designed to utilize all available space. Choose from Box/Box/File and File/File combinations as well as hanging pedestals. File drawers have high drawer sides for hanging folders and eliminate the need for file bars.

Models include Desks, Returns, Bridges, Credenzas, Hutches and Accessories such as a center drawer and optional keys for keying alike. This wide range of models, pedestal options and finish selections are sure to fit a variety of office and organizational needs.

Features and Benefits

- Tops are 1" thick with 3mm plastic edge banding
- Full to floor or hanging pedestals available
- Pencil tray is standard on box-box-file pedestals
- High wall drawer sides accommodate front-to-back hanging file folders and eliminate the need for costly hanging file frames
- 1" adjustable leveling glides standard on all units. Double pedestal desks have eight, Single pedestal desks use six
- Steel chassis are finished with an Earth friendly electrostatically applied powder paint process that protects the environment and provides a durable finish
- Available in a range of colors and finishes - see Notes for details



Tops are 1" thick with 3mm plastic edge banding



Full to floor pedestals



High drawer sides accommodate hanging folders

GENERAL INFORMATION

- Tops are constructed of 45 lb. density particleboard with high performance thermally fused laminate
- All tops have Global’s preferred edging in matching color (i.e. wood grain surfaces feature edging with matching wood grain)
- Chassis incorporates an earth friendly electrostatically applied powder paint process that protects the environment and provides a durable finish
- GREENGUARD INDOOR AIR QUALITY CERTIFICATION - Global laminate and seating products are in compliance with stringent emission guidelines set out by the Greenguard Environmental Institute under the standards for low emitting products and materials. www.greenguard.org.
- **Level 2 Certified**

CONSTRUCTION

- Tops are constructed of 45 lb. density particleboard with high performance thermally fused laminate. Tops are flush with end panels.
- Chassis is prime cold rolled commercial quality steel
- 1” adjustable leveling glides standard on all units. Double pedestal desks have eight, single pedestal desks use six

MODESTY PANELS

- Standard modesty panel heights are 18” (¾) and 26” (full)
- Hanging pedestal models are standard with a 20” modesty panel

LOCKS

- Locks have removable cores for keying alike

STORAGE

- Full extension ball-bearing suspension on file drawers, ¾ extension ball-bearing suspension on box drawers for smooth and durable drawer movement
- High wall drawer sides accommodate front-to-back hanging file folders and eliminate the need for costly hanging file frames

GROMMETS

- Grommets are available in standard worksurface locations (left, center or right). Order as: **AG1, AG2 or AG3 - Add \$52**
- Grommet hole dimensions are 3 ¼” wide x 1 7/8” deep.

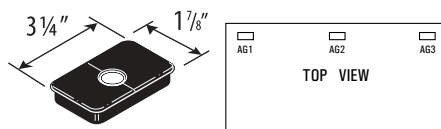

- Actual grommet locations on the worksurface are depicted in the example drawings shown below. Dimensions shown are actual measurements (in inches).
- Grommets are standard in corners, islands and extended corners only. Desks, returns and bridges have no standard grommet.

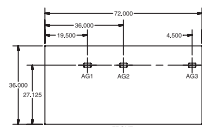

36 x 72 single pedestal left desks

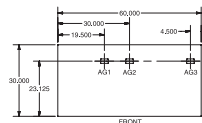

30 x 60 single pedestal left desks

- Grommets may be placed at non-standard locations. Order as: **AGS - Add \$52.00** A drawing must be supplied with vertical and horizontal dimensions to the center of the cut-out (as in drawing above). Please refer to CUSTOM GROMMET LOCATION FORM in the back reference section.

TOP FINISHES - LAMINATE

- ACJ Absolute Acajou
 - ASN Asian Night
 - AWC Avant Cherry
 - AWH Avant Honey
 - BLK Black
 - BRC Brushed Cobalt
 - CSJ Constellation Java
 - DES Dark Espresso
 - GRY Grey
 - HGT Hayden Grey
 - QTM Quartered Mahogany
 - SKC Shaker Cherry
 - SOG Storm Grey
 - TFW Tiger Fruitwood
 - TMA Tiger Mahogany
 - TMP Tiger Maple
 - TWL Tiger Walnut
 - WHT White
 - WHC White Chocolate*
 - WGY Willow Grey
 - WCR Winter Cherry
- * textured

BODY FINISHES (INCLUDING PEDESTALS) - METAL

Standard Paint Finishes

- BLK Black
- BGR Business Grey
- CGR Charcoal
- DPT Desert Putty
- GRY Grey
- LGR Light Grey
- SGR Storm Grey
- NEV Nevada
- TSA Tahiti Sand

Premium Paint Finishes

- F29 Bone
- F09 Claret
- F23 Cloud
- DWT Designer White
- F33 Ice
- F30 Ivory
- F07 Metro
- F05 Moss
- F19 Navy
- F35 Oyster
- F32 Stone
- TU2 Tungsten 2
- F28 Willow

Textured Paint Finishes

- U04 Black Coffee
- T19 Dark Chocolate
- T20 Cappuccino
- J52 Mocha
- J23 Vanilla

CUSTOM PAINT FINISHES

- All special colors must use ONE uniform color per series (example: Steel Desks). Quantities of 1 to 10 add 10%; 11 or more are NO UPCHARGE.
- Mica and Metallic: 10% upcharge will apply.
- White special finishes can be applied at 10% upcharge.
- ALL NONSTANDARD FINISHES MUST BE APPROVED BY GLOBAL BEFORE ANY ORDER WILL BE ACCEPTED. LONGER LEAD TIMES WILL APPLY.

DOUBLE PEDESTAL DESKS

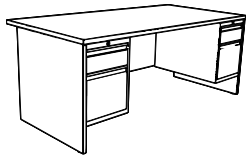

20" modesty

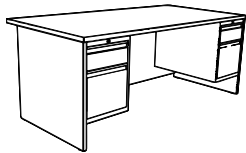

26" modesty

Double Pedestal Desk

MODEL#	DIMENSIONS	FREIGHT CLASS	WT/LBS.	CUBIC FT.	1" TOP	1.5" TOP	GLAZE ADD	HP ADD
--------	------------	---------------	---------	-----------	--------	----------	-----------	--------

D x W x H

SDM2448HH20	24 x 48 x 29	100	188	22.28				\$1324
SDM2454HH20	24 x 54 x 29	100	201.50	24.98				\$1351
SDM2460HH20	24 x 60 x 29	125	207	27.68				\$1377
SDM2466HH20	24 x 66 x 29	125	211.50	30.38				\$1395
SDM2472HH20	24 x 72 x 29	125	226	33.08				\$1407
SDM2448HH26	24 x 48 x 29	100	192	22.28				\$1333
SDM2454HH26	24 x 54 x 29	100	206	24.98				\$1361
SDM2460HH26	24 x 60 x 29	125	212	27.68				\$1389
SDM2466HH26	24 x 66 x 29	125	217	30.38				\$1407
SDM2472HH26	24 x 72 x 29	125	232	33.08				\$1421
SDM3048HH20	30 x 48 x 29	100	222.50	27.52				\$1630
SDM3054HH20	30 x 54 x 29	125	237	30.86				\$1661
SDM3060HH20	30 x 60 x 29	125	244	34.19				\$1683
SDM3066HH20	30 x 66 x 29	125	254.50	37.53				\$1733
SDM3072HH20	30 x 72 x 29	125	265	40.87				\$1769
SDM3048HH26	30 x 48 x 29	100	226.50	27.52				\$1639
SDM3054HH26	30 x 54 x 29	125	241.50	30.86				\$1671
SDM3060HH26	30 x 60 x 29	125	248.50	34.19				\$1694
SDM3066HH26	30 x 66 x 29	125	259.50	37.53				\$1745
SDM3072HH26	30 x 72 x 29	125	271	40.87				\$1782
SDM3660HH20	36 x 60 x 29	125	262.50	34.19				\$1785
SDM3666HH20	36 x 66 x 29	125	270	44.68				\$1797
SDM3672HH20	36 x 72 x 29	150	278	48.65				\$1806
SDM3660HH26	36 x 60 x 29	125	267.50	34.19				\$1792
SDM3666HH26	36 x 66 x 29	125	275.50	44.68				\$1810
SDM3672HH26	36 x 72 x 29	150	283.50	48.65				\$1819

Standard with **box/file** pedestals on both sides. Pedestal locks. One pencil tray.

- SDMxxxxHH20 has a 20" modesty panel
- SDM24xxBB26 has a 26" modesty panel
- 6.125" overhang on 36"D desks

Required Specifications

Top Finish
Body Finish

Optional Specifications

Grommet

DOUBLE PEDESTAL DESKS

MODEL# DIMENSIONS FREIGHT CLASS WT/LBS. CUBIC FT. LIST PRICE

D x W x H

SDM2448BB18	24 x 48 x 29	100	184	22.28	\$1213
SDM2454BB18	24 x 54 x 29	125	197.50	24.98	\$1240
SDM2460BB18	24 x 60 x 29	125	203	27.68	\$1266
SDM2466BB18	24 x 66 x 29	125	208	30.38	\$1284
SDM2472BB18	24 x 72 x 29	125	222	33.08	\$1296

SDM2448BB26	24 x 48 x 29	100	188	22.28	\$1222
SDM2454BB26	24 x 54 x 29	100	202	24.98	\$1250
SDM2460BB26	24 x 60 x 29	125	208	27.68	\$1278
SDM2466BB26	24 x 66 x 29	125	213	30.38	\$1296
SDM2472BB26	24 x 72 x 29	125	228	33.08	\$1310

SDM3048BB18	30 x 48 x 29	125	202.50	27.52	\$1546
SDM3054BB18	30 x 54 x 29	125	217	30.86	\$1578
SDM3060BB18	30 x 60 x 29	125	224	34.19	\$1600
SDM3066BB18	30 x 66 x 29	125	234.50	37.53	\$1649
SDM3072BB18	30 x 72 x 29	125	270	40	\$1685

SDM3048BB26	30 x 48 x 29	125	206.50	27.52	\$1556
SDM3054BB26	30 x 54 x 29	125	221.50	30.86	\$1588
SDM3060BB26	30 x 60 x 29	125	228.50	34.19	\$1611
SDM3066BB26	30 x 66 x 29	125	240	37.53	\$1662
SDM3072BB26	30 x 72 x 29	125	251	40.87	\$1699

SDM3660BB18	36 x 60 x 29	125	242.50	34.19	\$1701
SDM3666BB18	36 x 66 x 29	150	250	44.68	\$1714
SDM3672BB18	36 x 72 x 29	150	258	48.65	\$1722

SDM3660BB26	36 x 60 x 29	125	247.50	34.19	\$1708
SDM3666BB26	36 x 66 x 29	150	255.50	44.68	\$1727
SDM3672BB26	36 x 72 x 29	150	263.50	48.65	\$1736



18" modesty



26" modesty

Double Pedestal Desk

Standard with full to floor **box/box/file** pedestals on both sides. Pedestal locks. One pencil tray.

- SDMxxxxBB18 has an 18" modesty panel
- SDM24xxBB26 has a 26" modesty panel
- 6.125" overhang on 36"D desks

Required Specifications

Top Finish
Body Finish

Optional Specifications

Grommet

S STREAMLINE II™

DOUBLE PEDESTAL DESKS

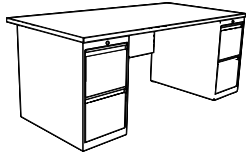

18" modesty

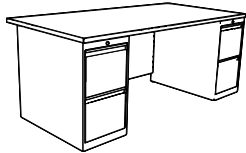

26" modesty

Double Pedestal Desk

MODEL#	DIMENSIONS D x W x H	FREIGHT CLASS	WT/LBS.	CUBIC FT.	LIST PRICE
SDM2448FF18	24 x 48 x 29	100	184	22.28	\$1213
SDM2454FF18	24 x 54 x 29	125	197.50	24.98	\$1240
SDM2460FF18	24 x 60 x 29	125	203	27.68	\$1266
SDM2466FF18	24 x 66 x 29	125	208	30.38	\$1284
SDM2472FF18	24 x 72 x 29	125	222	33.08	\$1296
SDM2448FF26	24 x 48 x 29	100	188	22.28	\$1222
SDM2454FF26	24 x 54 x 29	100	202	24.98	\$1250
SDM2460FF26	24 x 60 x 29	125	208	27.68	\$1278
SDM2466FF26	24 x 66 x 29	125	213	30.38	\$1296
SDM2472FF26	24 x 72 x 29	125	228	33.08	\$1310
SDM3048FF18	30 x 48 x 29	125	202.50	27.52	\$1546
SDM3054FF18	30 x 54 x 29	125	217	30.86	\$1578
SDM3060FF18	30 x 60 x 29	125	224	34.19	\$1600
SDM3066FF18	30 x 66 x 29	125	234.50	37.53	\$1649
SDM3072FF18	30 x 72 x 29	125	270	40	\$1685
SDM3048FF26	30 x 48 x 29	125	206.50	27.52	\$1556
SDM3054FF26	30 x 54 x 29	125	221.50	30.86	\$1588
SDM3060FF26	30 x 60 x 29	125	228.50	34.19	\$1611
SDM3066FF26	30 x 66 x 29	125	240	37.53	\$1662
SDM3072FF26	30 x 72 x 29	150	240	40.87	\$1699
SDM3660FF18	36 x 60 x 29	125	242.50	34.19	\$1701
SDM3666FF18	36 x 66 x 29	150	250	44.68	\$1714
SDM3672FF18	36 x 72 x 29	150	258	48.65	\$1722
SDM3660FF26	36 x 60 x 29	125	247.50	34.19	\$1708
SDM3666FF26	36 x 66 x 29	150	255.50	44.68	\$1727
SDM3672FF26	36 x 72 x 29	150	263.50	48.65	\$1736

Standard with full to floor **file/file** pedestals on both sides. Pedestal locks.

- SDMxxxxFF18 has an 18" modesty panel
- SDM24xxFF26 has a 26" modesty panel
- 6.125" overhang on 36"D desks

Required Specifications

Top Finish
Body Finish

Optional Specifications

Grommet

DOUBLE PEDESTAL DESKS

MODEL# DIMENSIONS FREIGHT CLASS WT/LBS. CUBIC FT. LIST PRICE

D x W x H

SDM2448FB18	24 x 48 x 29	100	184	22.28	\$1213
SDM2454FB18	24 x 54 x 29	125	197.50	24.98	\$1240
SDM2460FB18	24 x 60 x 29	125	203	27.68	\$1266
SDM2466FB18	24 x 66 x 29	125	208	30.38	\$1284
SDM2472FB18	24 x 72 x 29	125	222	33.08	\$1296
SDM2448FB26	24 x 48 x 29	100	188	22.28	\$1222
SDM2454FB26	24 x 54 x 29	100	202	24.98	\$1250
SDM2460FB26	24 x 60 x 29	125	208	27.68	\$1278
SDM2466FB26	24 x 66 x 29	125	213	30.38	\$1296
SDM2472FB26	24 x 72 x 29	125	228	33.08	\$1310
SDM3048FB18	30 x 48 x 29	125	202.50	27.52	\$1546
SDM3054FB18	30 x 54 x 29	125	217	30.86	\$1578
SDM3060FB18	30 x 60 x 29	125	224	34.19	\$1600
SDM3066FB18	30 x 66 x 29	125	234.50	37.53	\$1649
SDM3072FB18	30 x 72 x 29	150	245	40.87	\$1685
SDM3048FB26	30 x 48 x 29	125	206.50	27.52	\$1556
SDM3054FB26	30 x 54 x 29	125	221.50	30.86	\$1588
SDM3060FB26	30 x 60 x 29	125	228.50	34.19	\$1611
SDM3066FB26	30 x 66 x 29	125	240	37.53	\$1662
SDM3072FB26	30 x 72 x 29	125	251	40.87	\$1699
SDM3660FB18	36 x 60 x 29	125	242.50	34.19	\$1701
SDM3666FB18	36 x 66 x 29	150	250	44.68	\$1714
SDM3672FB18	36 x 72 x 29	150	258	48.65	\$1722
SDM3660FB26	36 x 60 x 29	125	247.50	34.19	\$1708
SDM3666FB26	36 x 66 x 29	150	255.50	44.68	\$1727
SDM3672FB26	36 x 72 x 29	150	263.50	48.65	\$1736



18" modesty

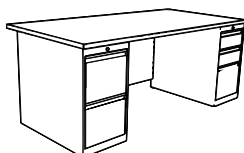

26" modesty

Double Pedestal Desk

Standard with full to floor **file/file** pedestal on **left** and **box/box/file** pedestal on **right**. Pedestal locks. One pencil tray.

- SDMxxxxFB18 has an 18" modesty panel
- SDMxxxxFB26 has a 26" modesty panel
- 6.125" overhang on 36"D desks

Required Specifications

Top Finish
Body Finish

Optional Specifications

Grommet

DOUBLE PEDESTAL DESKS



18" modesty



26" modesty

Double Pedestal Desk

MODEL#	DIMENSIONS D x W x H	FREIGHT CLASS	WT/LBS.	CUBIC FT.	LIST PRICE
SDM2448BF18	24 x 48 x 29	100	184	22.28	\$1213
SDM2454BF18	24 x 54 x 29	125	197.50	24.98	\$1240
SDM2460BF18	24 x 60 x 29	125	203	27.68	\$1266
SDM2466BF18	24 x 66 x 29	125	208	30.38	\$1284
SDM2472BF18	24 x 72 x 29	125	222	33.08	\$1296
SDM2448BF26	24 x 48 x 29	100	188	22.28	\$1222
SDM2454BF26	24 x 54 x 29	100	202	24.98	\$1250
SDM2460BF26	24 x 60 x 29	125	208	27.68	\$1278
SDM2466BF26	24 x 66 x 29	125	213	30.38	\$1296
SDM2472BF26	24 x 72 x 29	125	228	33.08	\$1310
SDM3048BF18	30 x 48 x 29	125	202.50	27.52	\$1546
SDM3054BF18	30 x 54 x 29	125	217	30.86	\$1578
SDM3060BF18	30 x 60 x 29	125	224	34.19	\$1600
SDM3066BF18	30 x 66 x 29	125	234.50	37.53	\$1649
SDM3072BF18	30 x 72 x 29	150	245	40.87	\$1685
SDM3048BF26	30 x 48 x 29	125	206.50	27.52	\$1556
SDM3054BF26	30 x 54 x 29	125	221.50	30.86	\$1588
SDM3060BF26	30 x 60 x 29	125	228.50	34.19	\$1611
SDM3066BF26	30 x 66 x 29	125	240	37.53	\$1662
SDM3072BF26	30 x 72 x 29	125	251	40.87	\$1699
SDM3660BF18	36 x 60 x 29	125	242.50	34.19	\$1701
SDM3666BF18	36 x 66 x 29	150	250	44.68	\$1714
SDM3672BF18	36 x 72 x 29	150	258	48.65	\$1722
SDM3660BF26	36 x 60 x 29	125	247.50	34.19	\$1708
SDM3666BF26	36 x 66 x 29	150	255.50	44.68	\$1727
SDM3672BF26	36 x 72 x 29	150	263.50	48.65	\$1736

Standard with full to floor **file/file** pedestal on **right** and **box/box/file** pedestal on **left**. Pedestal locks. One pencil tray.

- SDMxxxxBF18 has an 18" modesty panel
- SDMxxxxBF26 has a 26" modesty panel
- 6.125" overhang on 36"D desks

Required Specifications

Top Finish
Body Finish

Optional Specifications

Grommet

SINGLE PEDESTAL DESKS

MODEL# DIMENSIONS FREIGHT CLASS WT/LBS. CUBIC FT. LIST PRICE

D x W x H

SDM2430BG18	24 x 30 x 29	100	129.50	14.18	\$897
SDM2436BG18	24 x 36 x 29	125	135	16.88	\$924
SDM2442BG18	24 x 42 x 29	125	140.50	19.58	\$950
SDM2448BG18	24 x 48 x 29	125	146	22.28	\$977
SDM2454BG18	24 x 54 x 29	125	160	24.98	\$1003
SDM2460BG18	24 x 60 x 29	150	165	27.68	\$1030
SDM2466BG18	24 x 66 x 29	150	170	30.38	\$1047
SDM2472BG18	24 x 72 x 29	150	184	33.08	\$1060

SDM2430BG26	24 x 30 x 29	100	132	14.18	\$903
SDM2436BG26	24 x 36 x 29	100	138	16.88	\$931
SDM2442BG26	24 x 42 x 29	125	144	19.58	\$958
SDM2448BG26	24 x 48 x 29	125	150	22.28	\$986
SDM2454BG26	24 x 54 x 29	125	164	24.98	\$1014
SDM2460BG26	24 x 60 x 29	125	170	27.68	\$1042
SDM2466BG26	24 x 66 x 29	150	175	30.38	\$1060
SDM2472BG26	24 x 72 x 29	150	190	33.08	\$1074

SDM3030BG18	30 x 30 x 29	100	146	17.51	\$1161
SDM3036BG18	30 x 36 x 29	125	152.50	20.85	\$1188
SDM3042BG18	30 x 42 x 29	125	159	24.19	\$1214
SDM3048BG18	30 x 48 x 29	125	165.50	27.52	\$1241
SDM3054BG18	30 x 54 x 29	150	180	30.86	\$1272
SDM3060BG18	30 x 60 x 29	150	187	34.19	\$1294
SDM3066BG18	30 x 66 x 29	150	197.50	37.53	\$1344
SDM3072BG18	30 x 72 x 29	150	208	40.87	\$1380

SDM3030BG26	30 x 30 x 29	100	148.50	17.51	\$1167
SDM3036BG26	30 x 36 x 29	125	155.50	20.85	\$1194
SDM3042BG26	30 x 42 x 29	125	162.50	24.19	\$1222
SDM3048BG26	30 x 48 x 29	125	169.50	27.52	\$1250
SDM3054BG26	30 x 54 x 29	150	184.50	30.86	\$1282
SDM3060BG26	30 x 60 x 29	150	191.50	34.19	\$1306
SDM3066BG26	30 x 66 x 29	150	203	37.53	\$1356
SDM3072BG26	30 x 72 x 29	150	214	40.87	\$1394

SDM3660BG18	36 x 60 x 29	125	210.50	34.19	\$1396
SDM3666BG18	36 x 66 x 29	150	218	44.68	\$1409
SDM3672BG18	36 x 72 x 29	150	226	48.65	\$1417

SDM3660BG26	36 x 60 x 29	125	215.50	34.19	\$1403
SDM3666BG26	36 x 66 x 29	150	223.50	44.68	\$1421
SDM3672BG26	36 x 72 x 29	150	231.50	48.65	\$1431

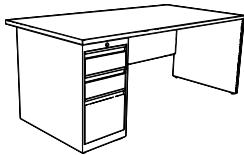

18" modesty



26" modesty

Single Pedestal Desk - Left

Standard with full to floor **box/box/file** pedestal on **left**. Pedestal lock. One pencil tray.

- SDMxxxxBG18 has an 18" modesty panel
- SDMxxxxBG26 has a 26" modesty panel
- 6.125" overhang on 36"D desks

Required Specifications

Top Finish
Body Finish

Optional Specifications

Grommet

SINGLE PEDESTAL DESKS

MODEL# DIMENSIONS FREIGHT CLASS WT/LBS. CUBIC FT. LIST PRICE

D x W x H

SDM2430GB18	24 x 30 x 29	100	129.50	14.18	\$897
SDM2436GB18	24 x 36 x 29	125	135	16.88	\$924
SDM2442GB18	24 x 42 x 29	125	140.50	19.58	\$950
SDM2448GB18	24 x 48 x 29	125	146	22.28	\$977
SDM2454GB18	24 x 54 x 29	125	160	24.98	\$1003
SDM2460GB18	24 x 60 x 29	150	165	27.68	\$1030
SDM2466GB18	24 x 66 x 29	150	170	30.38	\$1047
SDM2472GB18	24 x 72 x 29	150	184	33.08	\$1060

SDM2430GB26	24 x 30 x 29	100	132	14.18	\$903
SDM2436GB26	24 x 36 x 29	100	138	16.88	\$931
SDM2442GB26	24 x 42 x 29	125	144	19.58	\$958
SDM2448GB26	24 x 48 x 29	125	150	22.28	\$986
SDM2454GB26	24 x 54 x 29	125	164	24.98	\$1014
SDM2460GB26	24 x 60 x 29	125	170	27.68	\$1042
SDM2466GB26	24 x 66 x 29	150	175	30.38	\$1060
SDM2472GB26	24 x 72 x 29	150	190	33.08	\$1074

SDM3030GB18	30 x 30 x 29	100	146	17.51	\$1161
SDM3036GB18	30 x 36 x 29	125	152.50	20.85	\$1188
SDM3042GB18	30 x 42 x 29	125	159	24.19	\$1214
SDM3048GB18	30 x 48 x 29	125	165.50	27.52	\$1241
SDM3054GB18	30 x 54 x 29	150	180	30.86	\$1272
SDM3060GB18	30 x 60 x 29	150	187	34.19	\$1294
SDM3066GB18	30 x 66 x 29	150	197.50	37.53	\$1344
SDM3072GB18	30 x 72 x 29	150	270	40	\$1380

SDM3030GB26	30 x 30 x 29	100	148.50	17.51	\$1167
SDM3036GB26	30 x 36 x 29	125	155.50	20.85	\$1194
SDM3042GB26	30 x 42 x 29	125	162.50	24.19	\$1222
SDM3048GB26	30 x 48 x 29	125	169.50	27.52	\$1250
SDM3054GB26	30 x 54 x 29	150	184.50	30.86	\$1282
SDM3060GB26	30 x 60 x 29	150	191.50	34.19	\$1306
SDM3066GB26	30 x 66 x 29	150	203	37.53	\$1356
SDM3072GB26	30 x 72 x 29	150	203	40.87	\$1394

SDM3660GB18	36 x 60 x 29	125	210.50	34.19	\$1396
SDM3666GB18	36 x 66 x 29	150	218	44.68	\$1409
SDM3672GB18	36 x 72 x 29	150	226	48.65	\$1417

SDM3660GB26	36 x 60 x 29	125	215.50	34.19	\$1403
SDM3666GB26	36 x 66 x 29	150	223.50	44.68	\$1421
SDM3672GB26	36 x 72 x 29	150	231.50	48.65	\$1431

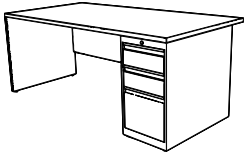

18" modesty

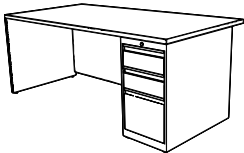

26" modesty

Single Pedestal Desk - Right

Standard with full to floor **box/box/file** pedestal on **right**. Pedestal lock.

- SDMxxxxGB18 has an 18" modesty panel
- SDM24xxGB26 has a 26" modesty panel
- 6.125" overhang on 36"D desks

Required Specifications

Top Finish
Body Finish

Optional Specifications

Grommet

SINGLE PEDESTAL DESKS

MODEL# DIMENSIONS FREIGHT CLASS WT/LBS. CUBIC FT. LIST PRICE

D x W x H

SDM2430FG18	24 x 30 x 29	100	129.50	14.18	\$897
SDM2436FG18	24 x 36 x 29	125	135	16.88	\$924
SDM2442FG18	24 x 42 x 29	125	140.50	19.58	\$950
SDM2448FG18	24 x 48 x 29	125	146	22.28	\$977
SDM2454FG18	24 x 54 x 29	125	160	24.98	\$1003
SDM2460FG18	24 x 60 x 29	150	165	27.68	\$1030
SDM2466FG18	24 x 66 x 29	150	170	30.38	\$1047
SDM2472FG18	24 x 72 x 29	150	184	33.08	\$1060

SDM2430FG26	24 x 30 x 29	100	132	14.18	\$903
SDM2436FG26	24 x 36 x 29	100	138	16.88	\$931
SDM2442FG26	24 x 42 x 29	125	144	19.58	\$958
SDM2448FG26	24 x 48 x 29	125	150	22.28	\$986
SDM2454FG26	24 x 54 x 29	125	164	24.98	\$1014
SDM2460FG26	24 x 60 x 29	125	170	27.68	\$1042
SDM2466FG26	24 x 66 x 29	150	165.50	30.38	\$1060
SDM2472FG26	24 x 72 x 29	150	190	33.08	\$1074

SDM3030FG18	30 x 30 x 29	100	146	17.51	\$1161
SDM3036FG18	30 x 36 x 29	125	152.50	20.85	\$1188
SDM3042FG18	30 x 42 x 29	125	159	24.19	\$1214
SDM3048FG18	30 x 48 x 29	125	165.50	27.52	\$1241
SDM3054FG18	30 x 54 x 29	150	180	30.86	\$1272
SDM3060FG18	30 x 60 x 29	150	187	34.19	\$1294
SDM3066FG18	30 x 66 x 29	150	197.50	37.53	\$1344
SDM3072FG18	30 x 72 x 29	150	208	40.87	\$1380

SDM3030FG26	30 x 30 x 29	100	148.50	17.51	\$1167
SDM3036FG26	30 x 36 x 29	125	155.50	20.85	\$1194
SDM3042FG26	30 x 42 x 29	125	162.50	24.19	\$1222
SDM3048FG26	30 x 48 x 29	125	169.50	27.52	\$1250
SDM3054FG26	30 x 54 x 29	150	184.50	30.86	\$1282
SDM3060FG26	30 x 60 x 29	150	191.50	34.19	\$1306
SDM3066FG26	30 x 66 x 29	150	203	37.53	\$1356
SDM3072FG26	30 x 72 x 29	150	214	40.87	\$1394

SDM3660FG18	36 x 60 x 29	125	210.50	34.19	\$1396
SDM3666FG18	36 x 66 x 29	150	218	44.68	\$1409
SDM3672FG18	36 x 72 x 29	150	226	48.65	\$1417

SDM3660FG26	36 x 60 x 29	125	215.50	34.19	\$1403
SDM3666FG26	36 x 66 x 29	150	223.50	44.68	\$1421
SDM3672FG26	36 x 72 x 29	150	231.50	48.65	\$1431

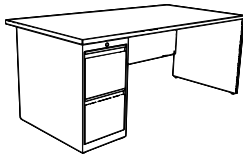

18" modesty

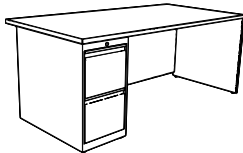

26" modesty

Single Pedestal Desk - Left

Standard with full to floor **file/file** pedestal on **left**. Pedestal lock.

- SDMxxxxFG18 has an 18" modesty panel
- SDMxxxxFG26 has a 26" modesty panel
- 6.125" overhang on 36"D desks

Required Specifications

Top Finish
Body Finish

Optional Specifications

Grommet

SINGLE PEDESTAL DESKS

MODEL# DIMENSIONS FREIGHT CLASS WT/LBS. CUBIC FT. LIST PRICE

D x W x H

SDM2430GF18	24 x 30 x 29	100	129.50	14.18	\$897
SDM2436GF18	24 x 36 x 29	125	135	16.88	\$924
SDM2442GF18	24 x 42 x 29	125	140.50	19.58	\$950
SDM2448GF18	24 x 48 x 29	125	146	22.28	\$977
SDM2454GF18	24 x 54 x 29	125	160	24.98	\$1003
SDM2460GF18	24 x 60 x 29	150	165	27.68	\$1030
SDM2466GF18	24 x 66 x 29	150	170	30.38	\$1047
SDM2472GF18	24 x 72 x 29	150	184	33.08	\$1060

SDM2430GF26	24 x 30 x 29	100	132	14.18	\$903
SDM2436GF26	24 x 36 x 29	100	138	16.88	\$931
SDM2442GF26	24 x 42 x 29	125	144	19.58	\$958
SDM2448GF26	24 x 48 x 29	125	150	22.28	\$986
SDM2454GF26	24 x 54 x 29	125	164	24.98	\$1014
SDM2460GF26	24 x 60 x 29	125	170	27.68	\$1042
SDM2466GF26	24 x 66 x 29	150	175	30.38	\$1060
SDM2472GF26	24 x 72 x 29	150	190	33.08	\$1074

SDM3030GF18	30 x 30 x 29	100	146	17.51	\$1161
SDM3036GF18	30 x 36 x 29	125	152.50	20.85	\$1188
SDM3042GF18	30 x 42 x 29	125	159	24.19	\$1214
SDM3048GF18	30 x 48 x 29	125	165.50	27.52	\$1241
SDM3054GF18	30 x 54 x 29	150	180	30.86	\$1272
SDM3060GF18	30 x 60 x 29	150	187	34.19	\$1294
SDM3066GF18	30 x 66 x 29	150	197.50	37.53	\$1344
SDM3072GF18	30 x 72 x 29	150	208	40.87	\$1380

SDM3030GF26	30 x 30 x 29	100	148.50	17.51	\$1167
SDM3036GF26	30 x 36 x 29	125	155.50	20.85	\$1194
SDM3042GF26	30 x 42 x 29	125	162.50	24.19	\$1222
SDM3048GF26	30 x 48 x 29	125	169.50	27.52	\$1250
SDM3054GF26	30 x 54 x 29	150	184.50	30.86	\$1282
SDM3060GF26	30 x 60 x 29	150	191.50	34.19	\$1306
SDM3066GF26	30 x 66 x 29	150	203	37.53	\$1356
SDM3072GF26	30 x 72 x 29	150	214	40.87	\$1394

SDM3660GF18	36 x 60 x 29	125	210.50	34.19	\$1396
SDM3666GF18	36 x 66 x 29	150	218	44.68	\$1409
SDM3672GF18	36 x 72 x 29	150	226	48.65	\$1417

SDM3660GF26	36 x 60 x 29	125	215.50	34.19	\$1403
SDM3666GF26	36 x 66 x 29	150	223.50	44.68	\$1421
SDM3672GF26	36 x 72 x 29	150	231.50	48.65	\$1431

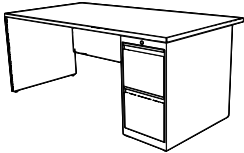

18" modesty

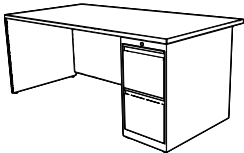

26" modesty

Single Pedestal Desk - Right

Standard with full to floor **file/file** pedestal on **right**. Pedestal lock.

- SDMxxxxGF18 has an 18" modesty panel
- SDMxxxxGF26 has a 26" modesty panel
- 6.125" overhang on 36"D desks

Required Specifications

Top Finish
Body Finish

Optional Specifications

Grommet

SINGLE PEDESTAL DESKS

MODEL# DIMENSIONS FREIGHT CLASS WT/LBS. CUBIC FT. LIST PRICE

D x W x H

SDM2430HG20	24 x 30 x 29	100	131.50	14.18	\$953
SDM2436HG20	24 x 36 x 29	100	137	16.88	\$979
SDM2442HG20	24 x 42 x 29	125	143	19.58	\$1006
SDM2448HG20	24 x 48 x 29	125	148	22.28	\$1032
SDM2454HG20	24 x 54 x 29	125	161.50	24.98	\$1059
SDM2460HG20	24 x 60 x 29	125	167	27.68	\$1086
SDM2466HG20	24 x 66 x 29	150	172	30.38	\$1103
SDM2472HG20	24 x 72 x 29	150	186	33.08	\$1116

SDM2430HG26	24 x 30 x 29	100	134	14.18	\$958
SDM2436HG26	24 x 36 x 29	100	140	16.88	\$986
SDM2442HG26	24 x 42 x 29	125	146	19.58	\$1014
SDM2448HG26	24 x 48 x 29	125	152	22.28	\$1042
SDM2454HG26	24 x 54 x 29	125	166	24.98	\$1069
SDM2460HG26	24 x 60 x 29	125	172	27.68	\$1097
SDM2466HG26	24 x 66 x 29	150	177	30.38	\$1116
SDM2472HG26	24 x 72 x 29	150	192	33.08	\$1130

SDM3030HG20	30 x 30 x 29	100	143	17.51	\$1203
SDM3036HG20	30 x 36 x 29	125	162.50	20.85	\$1229
SDM3042HG20	30 x 42 x 29	125	169	24.19	\$1256
SDM3048HG20	30 x 48 x 29	125	175.50	27.52	\$1282
SDM3054HG20	30 x 54 x 29	125	190	30.86	\$1314
SDM3060HG20	30 x 60 x 29	150	197	34.19	\$1336
SDM3066HG20	30 x 66 x 29	150	207.50	37.53	\$1385
SDM3072HG20	30 x 72 x 29	150	218	40.87	\$1421

SDM3030HG26	30 x 30 x 29	100	145.50	17.51	\$1208
SDM3036HG26	30 x 36 x 29	125	165.50	20.85	\$1236
SDM3042HG26	30 x 42 x 29	125	172.50	24.19	\$1264
SDM3048HG26	30 x 48 x 29	125	180	27.52	\$1292
SDM3054HG26	30 x 54 x 29	125	194.50	30.86	\$1324
SDM3060HG26	30 x 60 x 29	150	201.50	34.19	\$1347
SDM3066HG26	30 x 66 x 29	150	213	37.53	\$1398
SDM3072HG26	30 x 72 x 29	150	224	40.87	\$1435

SDM3660HG20	36 x 60 x 29	125	220.50	34.19	\$1438
SDM3666HG20	36 x 66 x 29	150	228	44.68	\$1450
SDM3672HG20	36 x 72 x 29	150	238	48.65	\$1458

SDM3660HG26	36 x 60 x 29	125	225.50	34.19	\$1444
SDM3666HG26	36 x 66 x 29	150	233.50	44.68	\$1463
SDM3672HG26	36 x 72 x 29	150	241.50	48.65	\$1472

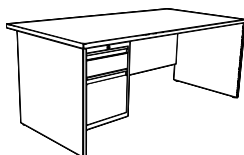

20" modesty



26" modesty

Single Pedestal Desk - Left

Standard with **box/file** pedestal on **left**. Pedestal lock. One pencil tray.

- SDMxxxxHG20 has a 20" modesty panel
- SDMxxxxHG26 has a 26" modesty panel
- 6.125" overhang on 36"D desks

Required Specifications

Top Finish
Body Finish

Optional Specifications

Grommet

SINGLE PEDESTAL DESKS

MODEL# DIMENSIONS FREIGHT CLASS WT/LBS. CUBIC FT. LIST PRICE

D x W x H

SDM2430GH20	24 x 30 x 29	100	131.50	14.18	\$953
SDM2436GH20	24 x 36 x 29	100	137	16.88	\$979
SDM2442GH20	24 x 42 x 29	125	143	19.58	\$1006
SDM2448GH20	24 x 48 x 29	125	148	22.28	\$1032
SDM2454GH20	24 x 54 x 29	125	161.50	24.98	\$1059
SDM2460GH20	24 x 60 x 29	125	167	27.68	\$1086
SDM2466GH20	24 x 66 x 29	150	172	30.38	\$1103
SDM2472GH20	24 x 72 x 29	150	186	33.08	\$1116

SDM2430GH26	24 x 30 x 29	100	134	14.18	\$958
SDM2436GH26	24 x 36 x 29	100	140	16.88	\$986
SDM2442GH26	24 x 42 x 29	125	146	19.58	\$1014
SDM2448GH26	24 x 48 x 29	125	152	22.28	\$1042
SDM2454GH26	24 x 54 x 29	125	166	24.98	\$1069
SDM2460GH26	24 x 60 x 29	125	172	27.68	\$1097
SDM2466GH26	24 x 66 x 29	150	177	30.38	\$1116
SDM2472GH26	24 x 72 x 29	150	192	33.08	\$1130

SDM3030GH20	30 x 30 x 29	100	143	17.51	\$1203
SDM3036GH20	30 x 36 x 29	125	162.50	20.85	\$1229
SDM3042GH20	30 x 42 x 29	125	169	24.19	\$1256
SDM3048GH20	30 x 48 x 29	125	175.50	27.52	\$1282
SDM3054GH20	30 x 54 x 29	125	190	30.86	\$1314
SDM3060GH20	30 x 60 x 29	150	197	34.19	\$1336
SDM3066GH20	30 x 66 x 29	150	207.50	37.53	\$1385
SDM3072GH20	30 x 72 x 29	150	218	40.87	\$1421

SDM3030GH26	30 x 30 x 29	100	145.50	17.51	\$1208
SDM3036GH26	30 x 36 x 29	125	165.50	20.85	\$1236
SDM3042GH26	30 x 42 x 29	125	172.50	24.19	\$1264
SDM3048GH26	30 x 48 x 29	125	180	27.52	\$1292
SDM3054GH26	30 x 54 x 29	125	194.50	30.86	\$1324
SDM3060GH26	30 x 60 x 29	150	201.50	34.19	\$1347
SDM3066GH26	30 x 66 x 29	150	213	37.53	\$1398
SDM3072GH26	30 x 72 x 29	150	224	40.87	\$1435

SDM3660GH20	36 x 60 x 29	125	220.50	34.19	\$1438
SDM3666GH20	36 x 66 x 29	150	228	44.68	\$1450
SDM3672GH20	36 x 72 x 29	150	241.50	48.65	\$1458

SDM3660GH26	36 x 60 x 29	125	225.50	34.19	\$1444
SDM3666GH26	36 x 66 x 29	150	233.50	44.68	\$1463
SDM3672GH26	36 x 72 x 29	150	236	48.65	\$1472

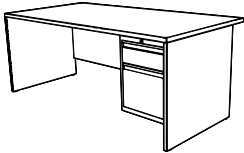

20" modesty

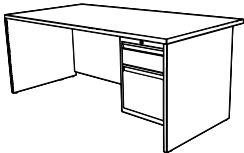

26" modesty

Single Pedestal Desk - Right

Standard with **box/file** pedestal on **right**. Pedestal lock. One pencil tray.

- SDMxxxxGH20 has a 20" modesty panel
- SDMxxxxGH26 has a 26" modesty panel
- 6.125" overhang on 36"D desks

Required Specifications

Paint Finish
Body Finish

Optional Specifications

Grommet

DESK SHELLS

MODEL# DIMENSIONS FREIGHT CLASS WT/LBS. CUBIC FT. LIST PRICE

D x W x H

SDM2430GG18	24 x 30 x 29	125	92	14.18	\$661
SDM2436GG18	24 x 36 x 29	150	97.50	16.88	\$688
SDM2442GG18	24 x 42 x 29	150	103	19.58	\$714
SDM2448GG18	24 x 48 x 29	150	108	22.28	\$741
SDM2454GG18	24 x 54 x 29	150	122	24.98	\$767
SDM2460GG18	24 x 60 x 29	150	127.50	27.68	\$794
SDM2466GG18	24 x 66 x 29	150	170	30.38	\$811
SDM2472GG18	24 x 72 x 29	150	146.50	33.08	\$824

SDM2430GG26	24 x 30 x 29	125	94	14.18	\$667
SDM2436GG26	24 x 36 x 29	150	100	16.88	\$694
SDM2442GG26	24 x 42 x 29	150	106	19.58	\$722
SDM2448GG26	24 x 48 x 29	150	112	22.28	\$750
SDM2454GG26	24 x 54 x 29	150	126	24.98	\$778
SDM2460GG26	24 x 60 x 29	150	132	27.68	\$806
SDM2466GG26	24 x 66 x 29	150	175	30.38	\$824
SDM2472GG26	24 x 72 x 29	150	152	33.08	\$838

SDM3030GG18	30 x 30 x 29	125	109	17.51	\$855
SDM3036GG18	30 x 36 x 29	150	115.50	20.85	\$882
SDM3042GG18	30 x 42 x 29	150	122	24.19	\$909
SDM3048GG18	30 x 48 x 29	150	128.50	27.52	\$935
SDM3054GG18	30 x 54 x 29	150	143	30.86	\$966
SDM3060GG18	30 x 60 x 29	150	150	34.19	\$988
SDM3066GG18	30 x 66 x 29	150	160.50	37.53	\$1038
SDM3072GG18	30 x 72 x 29	150	171	40.87	\$1074

SDM3030GG26	30 x 30 x 29	125	111.50	17.51	\$861
SDM3036GG26	30 x 36 x 29	150	118.50	20.85	\$889
SDM3042GG26	30 x 42 x 29	150	125.50	24.19	\$917
SDM3048GG26	30 x 48 x 29	150	132.50	27.52	\$977
SDM3054GG26	30 x 54 x 29	150	147.50	30.86	\$977
SDM3060GG26	30 x 60 x 29	150	146	34.19	\$1000
SDM3066GG26	30 x 66 x 29	150	166	37.53	\$1051
SDM3072GG26	30 x 72 x 29	150	177	40.87	\$1088

SDM3660GG18	36 x 60 x 29	150	178.50	34.19	\$1090
SDM3666GG18	36 x 66 x 29	150	222	44.68	\$1103
SDM3672GG18	36 x 72 x 29	150	205	48.65	\$1111

SDM3660GG26	36 x 60 x 29	150	183.50	34.19	\$1100
SDM3666GG26	36 x 66 x 29	150	227.50	44.68	\$1116
SDM3672GG26	36 x 72 x 29	150	220	48.65	\$1125

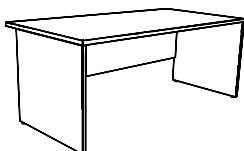

18" modesty

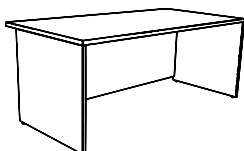

26" modesty

Desk Shell

- SDMxxxxGG18 has an 18" modesty panel
- SDMxxxxGG26 has a 26" modesty panel
- 6.125" overhang on 36"D desks

Required Specifications

Paint Finish
Body Finish

CORNERS

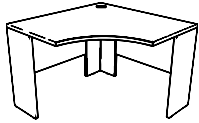

Curved Corner, 20" Throat

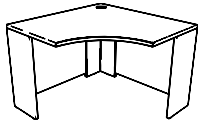

Curved Corner, 24" Throat

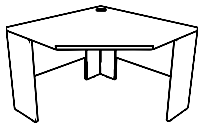

5-Sided Corner, 20" Throat

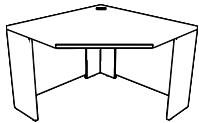

5-Sided Corner, 24" Throat

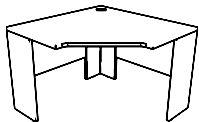

Keyboard Corner, 20" Throat

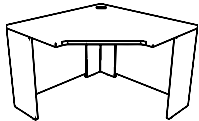

Keyboard Corner, 24" Throat

MODEL#	DIMENSIONS D x W x H	FREIGHT CLASS	WT/LBS.	CUBIC FT.	LIST PRICE
SCM2036RND18	36 x 36 x 29	150	116.80	24.82	\$1132
SCM2042RND18	42 x 42 x 29	250	127.80	33.40	\$1167
SCM2036RND26	36 x 36 x 29	150	121.10	24.82	\$1148
SCM2042RND26	42 x 42 x 29	250	133.30	33.40	\$1183

- SCM20xxRND18 has an 18" modesty panel
- SCM20xxRND26 has a 26" modesty panel

SCM2436RND18	36 x 36 x 29	150	116.80	24.82	\$1132
SCM2442RND18	42 x 42 x 29	150	142.10	33.40	\$1167
SCM2436RND26	36 x 36 x 29	150	121.10	24.82	\$1148
SCM2442RND26	42 x 42 x 29	150	147.60	33.40	\$1183

- SCM24xxRND18 has an 18" modesty panel
- SCM24xxRND26 has a 26" modesty panel

SCM2036STR18	36 x 36 x 29	150	118.90	24.82	\$1123
SCM2042STR18	42 x 42 x 29	250	131.80	33.40	\$1157
SCM2036STR26	36 x 36 x 29	150	123.30	24.82	\$1139
SCM2042STR26	42 x 42 x 29	150	137.30	33.40	\$1174

- SCM20xxSTR18 has an 18" modesty panel
- SCM20xxSTR26 has a 26" modesty panel

SCM2436STR18	36 x 36 x 29	150	118.90	24.82	\$1123
SCM2442STR18	42 x 42 x 29	250	131.80	33.40	\$1157
SCM2436STR26	36 x 36 x 29	150	123.30	24.82	\$1139
SCM2442STR26	42 x 42 x 29	150	137.30	33.40	\$1174

- SCM24xxSTR18 has an 18" modesty panel
- SCM24xxSTR26 has a 26" modesty panel

SCM2036SVR18	36 x 36 x 29	150	117.60	24.82	\$1146
SCM2042SVR18	42 x 42 x 29	250	130	33.40	\$1181
SCM2036SVR26	36 x 36 x 29	150	122	24.82	\$1162
SCM2042SVR26	42 x 42 x 29	150	135.50	33.40	\$1197

- SCM20xxSVR18 has an 18" modesty panel
- SCM20xxSVR26 has a 26" modesty panel

SCM2436SVR18	36 x 36 x 29	150	117.60	24.82	\$1146
SCM2442SVR18	42 x 42 x 29	250	130	33.40	\$1181
SCM2436SVR26	36 x 36 x 29	150	122	24.82	\$1162
SCM2442SVR26	42 x 42 x 29	250	132.30	33.40	\$1197

- SCM24xxSVR18 has an 18" modesty panel
- SCM24xxSVR26 has a 26" modesty panel

Required Specifications

Top Finish
Body Finish

Optional Specifications

Grommet

LEFT EXTENDED CORNERS

MODEL# DIMENSIONS FREIGHT CLASS WT./LBS. CUBIC FT. LIST PRICE

D x W x H

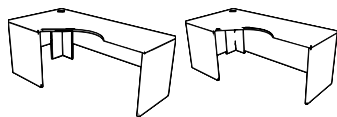

SDM2066FFL18	36 x 66 x 29	250	154.50	44.68	\$1056
SDM2072FFL18	36 x 72 x 29	250	169	48.65	\$1056
SDM2066FFL26	36 x 66 x 29	250	159	44.68	\$1074
SDM2072FFL26	36 x 72 x 29	250	173.50	48.65	\$1074

Left Extended Corner, 20" Throat

Extended worksurface on **right**. **Full end panels on left and right**. Connects to **24" D** space saver returns and **20" D** returns.

- SDM20xxFFL18 has an 18" modesty panel • SDM20xxFFL26 has a 26" modesty panel
- GWPSS pedestals **will not fit** properly under the extended end of **66" w** extended corners; available space measures 13.8"

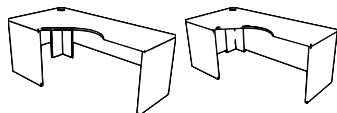

SDM2466FFL18	36 x 66 x 29	250	158.50	44.68	\$1111
SDM2472FFL18	36 x 72 x 29	250	173	48.65	\$1190
SDM2466FFL26	36 x 66 x 29	250	163	44.68	\$1130
SDM2472FFL26	36 x 72 x 29	250	177.50	48.65	\$1204

Left Extended Corner, 24" Throat

Extended worksurface on **right**. **Full end panels on left and right**. Connects to **30" D** space saver returns and **24" D** returns.

- SDM24xxFFL18 has an 18" modesty panel • SDM24xxFFL26 has a 26" modesty panel
- GWPSS pedestals **will not fit** properly under the extended end of **66" w** extended corners; available space measures 13.8"

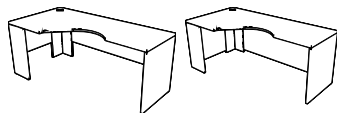

SDM2066NFL18	36 x 66 x 29	250	142.50	44.68	\$1028
SDM2072NFL18	36 x 72 x 29	250	157	48.65	\$1028
SDM2066NFL26	36 x 66 x 29	250	147	44.68	\$1046
SDM2072NFL26	36 x 72 x 29	250	161.50	48.65	\$1046

Left Extended Corner, 20" Throat

Extended worksurface on **right**. **Narrow end panel on left. Full end panel on right**. Connects to **24" D** space saver return or **20" D** returns. Corner has one grommet.

- SDM20xxNFL18 has an 18" modesty panel • SDM20xxNFL26 has a 26" modesty panel
- GWPSS pedestals **will not fit** properly under the extended end of **66" w** extended corners; available space measures 13.8"

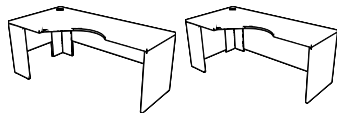

SDM2466NFL18	36 x 66 x 29	250	146.50	44.68	\$1083
SDM2472NFL18	36 x 72 x 29	250	161	48.65	\$1111
SDM2466NFL26	36 x 66 x 29	250	151	44.68	\$1102
SDM2472NFL26	36 x 72 x 29	250	165.50	48.65	\$1130

Left Extended Corner, 24" Throat

Extended worksurface on **right**. **Narrow end panel on left. Full end panel on right**. Connects to **30" D** space saver return or **24" D** returns. Corner has one grommet.

- SDM24xxNFL18 has an 18" modesty panel. • SDM24xxNFL26 has a 26" modesty panel
- GWPSS pedestals **will not fit** properly under the extended end of **66" w** extended corners; available space measures 13.8"

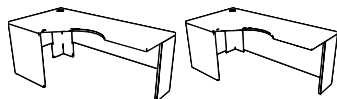

SDM2066FNL18	36 x 66 x 29	250	142.50	44.68	\$1028
SDM2072FNL18	36 x 72 x 29	250	157	48.65	\$1028
SDM2066FNL26	36 x 66 x 29	250	147	44.68	\$1046
SDM2072FNL26	36 x 72 x 29	250	161.50	48.65	\$1046

Left Extended Corner, 20" Throat

Extended worksurface on **right**. **Narrow end panel on right. Full end panel on left**. Connects to **24" D** space saver returns or **20" D** returns. Corner has one grommet.

- SDM20xxFNL18 has an 18" modesty panel • SDM20xxFNL26 has a 26" modesty panel
- GWPSS pedestals **will not fit** properly under the extended end of **66" w** extended corners; available space measures 13.8"

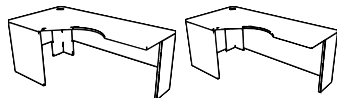

SDM2466FNL18	36 x 66 x 29	250	146.50	44.68	\$1083
SDM2472FNL18	36 x 72 x 29	250	161	48.65	\$1111
SDM2466FNL26	36 x 66 x 29	250	151	44.68	\$1102
SDM2472FNL26	36 x 72 x 29	250	165.50	48.65	\$1130

Left Extended Corner, 24" Throat

Extended worksurface on **right**. **Narrow end panel on right. Full end panel on left**. Connects to **30" D** space saver returns or **24" D** returns. Corner has one grommet.

- SDM24xxFNL18 has an 18" modesty panel • SDM24xxFNL26 has a 26" modesty panel
- GWPSS pedestals **will not fit** properly under the extended end of **66" w** extended corners; available space measures 13.8"

Required Specifications

Top Finish
Body Finish

Optional Specifications

Grommet

RIGHT EXTENDED CORNERS

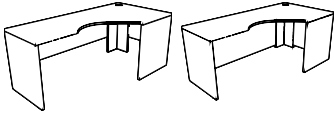

Right Extended Corner, 20" Throat

MODEL#	DIMENSIONS D x W x H	FREIGHT CLASS	WT./LBS.	CUBIC FT.	LIST PRICE
SDM2066FFR18	36 x 66 x 29	250	154.50	44.68	\$1056
SDM2072FFR18	36 x 72 x 29	250	169	48.65	\$1056
SDM2066FFR26	36 x 66 x 29	250	159	44.68	\$1074
SDM2072FFR26	36 x 72 x 29	250	173.50	48.65	\$1074

Extended worksurface on **left**. **Full end panels on left and right**. Connects to **24"D** space saver return and **20"D** returns.

- SDM20xxFFR18 has an 18" modesty panel • SDM20xxFFR26 has a 26" modesty panel
- GWPSS pedestals **will not fit** properly under the extended end of **66" w** extended corners; available space measures 13.8"

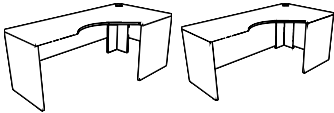

Right Extended Corner, 24" Throat

SDM2466FFR18	36 x 66 x 29	250	158.50	44.68	\$1111
SDM2472FFR18	36 x 72 x 29	250	173	48.65	\$1190
SDM2466FFR26	36 x 66 x 29	250	163	44.68	\$1130
SDM2472FFR26	36 x 72 x 29	250	177.50	48.65	\$1204

Extended worksurface on **left**. **Full end panels on left and right**. Connects to **30"D** space saver return and **24"D** returns.

- SDM24xxFFR18 has an 18" modesty panel • SDM24xxFFR26 has a 26" modesty panel
- GWPSS pedestals **will not fit** properly under the extended end of **66" w** extended corners; available space measures 13.8"

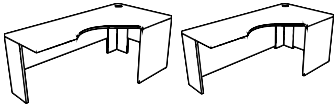

Right Extended Corner, 20" Throat

SDM2066NFR18	36 x 66 x 29	250	142.50	44.68	\$1028
SDM2072NFR18	36 x 72 x 29	250	157	48.65	\$1028
SDM2066NFR26	36 x 66 x 29	250	147	44.68	\$1046
SDM2072NFR26	36 x 72 x 29	250	161.50	48.65	\$1046

Extended worksurface on **left**. **Narrow end panel on left. Full end panel on right**. Connects to **24"D** space saver return or **20"D** returns. Corner has one grommet.

- SDM20xxNFR18 has an 18" modesty panel • SDM20xxNFR26 has a 26" modesty panel
- GWPSS pedestals **will not fit** properly under the extended end of **66" w** extended corners; available space measures 13.8"

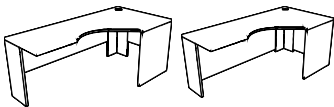

Right Extended Corner, 24" Throat

SDM2466NFR18	36 x 66 x 29	250	146.50	44.68	\$1083
SDM2472NFR18	36 x 72 x 29	250	161	48.65	\$1111
SDM2466NFR26	36 x 66 x 29	250	151	44.68	\$1102
SDM2472NFR26	36 x 72 x 29	250	165.50	48.65	\$1130

Extended worksurface on **left**. **Narrow end panel on left. Full end panel on right**. Connects to **30"D** space saver return or **24"D** returns. Corner has one grommet.

- SDM24xxNFR18 has an 18" modesty panel • SDM24xxNFR26 has a 26" modesty panel
- GWPSS pedestals **will not fit** properly under the extended end of **66" w** extended corners; available space measures 13.8"

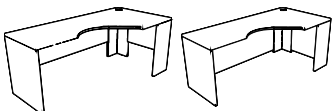

Right Extended Corner, 20" Throat

SDM2066FNR18	36 x 66 x 29	250	142.50	44.68	\$1028
SDM2072FNR18	36 x 72 x 29	250	157	48.65	\$1028
SDM2066FNR26	36 x 66 x 29	250	147	44.68	\$1046
SDM2072FNR26	36 x 72 x 29	250	161.50	48.65	\$1046

Extended worksurface on **left**. **Narrow end panel on right. Full end panel on left**. Connects to **24"D** space saver returns or **20"D** returns. Corner has one grommet.

- SDM20xxFNR18 has an 18" modesty panel • SDM20xxFNR26 has a 26" modesty panel
- GWPSS pedestals **will not fit** properly under the extended end of **66" w** extended corners; available space measures 13.8"

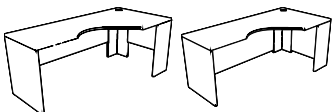

Right Extended Corner, 24" Throat

SDM2466FNR18	36 x 66 x 29	250	146.50	44.68	\$1083
SDM2472FNR18	36 x 72 x 29	250	161	48.65	\$1111
SDM2466FNR26	36 x 66 x 29	250	151	44.68	\$1102
SDM2472FNR26	36 x 72 x 29	250	165.50	48.65	\$1130

Extended worksurface on **left**. **Narrow end panel on right. Full end panel on left**. Connects to **30"D** space saver returns or **24"D** returns. Corner has one grommet.

- SDM24xxFNR18 has an 18" modesty panel • SDM24xxFNR26 has a 26" modesty panel.
- GWPSS pedestals **will not fit** properly under the extended end of **66" w** extended corners; available space measures 13.8"

Required Specifications

Top Finish
Body Finish

Optional Specifications

Grommet

ISLANDS

MODEL# DIMENSIONS FREIGHT CLASS WT./LBS. CUBIC FT. LIST PRICE

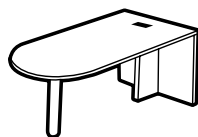

"D" Island - Full End Panel & Post (T-Base)

D x W x H						
SDIM3060	30 x 60 x 29	150	150	34.19		\$838
SDIM3066	30 x 66 x 29	150	205	37.53		\$898
SDIM3072	30 x 72 x 29	150	220	40.87		\$956
SDIM3660	36 x 60 x 29	250	157	40.70		\$829
SDIM3666	36 x 66 x 29	150	212	44.67		\$884
SDIM3672	36 x 72 x 29	150	227	48.20		\$940

Connects to narrow end panel. Attaching hardware included. **Not freestanding.**

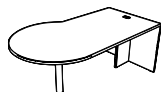

"P" Island LEFT - Full End Panel & Post (T-Base)

SPIM3060L	30 x 60 x 29	150	160	34.19		\$829
SPIM3066L	30 x 66 x 29	150	215	37.53		\$884
SPIM3072L	30 x 72 x 29	150	230	40.87		\$940
SPIM3660L	36 x 60 x 29	250	113	52		\$991
SPIM3666L	36 x 66 x 29	250	113	52		\$1074
SPIM3672L	36 x 72 x 29	150	237	48.20		\$1157

Connects to left side of worksurface. Attaching hardware included. **Not freestanding.** Grommet in worksurface.



"P" Island RIGHT - Full End Panel & Post (T-Base)

SPIM3060R	30 x 60 x 29	150	160	34.19		\$829
SPIM3066R	30 x 66 x 29	150	215	37.53		\$884
SPIM3072R	30 x 72 x 29	150	230	40.87		\$940
SPIM3660R	36 x 60 x 29	250	113	52		\$991
SPIM3666R	36 x 66 x 29	250	113	52		\$1074
SPIM3672R	36 x 72 x 29	150	237	48.20		\$1157

Connects to right side of worksurface. Attaching hardware included. **Not freestanding.** Grommet in worksurface.

BRIDGES

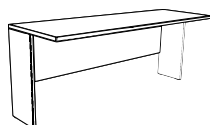

18" modesty

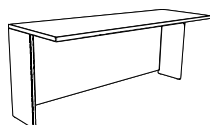

26" modesty

Bridge

SBM243018	24 x 36 x 29	250	56	14.18		\$603
SBM243618	24 x 36 x 29	250	67.50	16.88		\$631
SBM244218	24 x 42 x 29	150	79	19.58		\$659
SBM244818	24 x 48 x 29	250	84.50	22.28		\$685
SBM245418	24 x 54 x 29	250	98	24.98		\$712
SBM246018	24 x 60 x 29	250	103.50	27.68		\$738
SBM246618	24 x 66 x 29	250	108	30.38		\$756
SBM247218	24 x 72 x 29	250	122.50	33.08		\$769
SBM243026	24 x 36 x 29	150	58	14.18		\$612
SBM243626	24 x 36 x 29	150	70	16.88		\$639
SBM244226	24 x 42 x 29	150	82	19.58		\$667
SBM244826	24 x 48 x 29	250	88	22.28		\$694
SBM245426	24 x 54 x 29	150	102	24.98		\$722
SBM246026	24 x 60 x 29	250	108	27.68		\$750
SBM246626	24 x 66 x 29	250	113.50	30.38		\$769
SBM247226	24 x 72 x 29	250	128	33.08		\$782

- SBM24xx18 has an 18" modesty panel
- SBM24xx26 has a 26" modesty panel

Required Specifications

Top Finish
Body Finish

Optional Specifications

Grommet

RETURNS

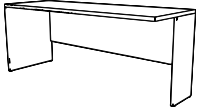

18" modesty

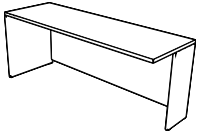

26" modesty

Return Shell - Left

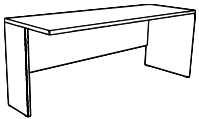

18" modesty

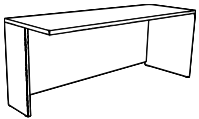

26" modesty

Return Shell - Right

MODEL#	DIMENSIONS	FREIGHT CLASS	WT/LBS.	CUBIC FT.	LIST PRICE
--------	------------	---------------	---------	-----------	------------

D x W x H

SRM2430LG18	24 x 30 x 29	150	80	14.18	\$633
SRM2436LG18	24 x 36 x 29	125	120	20	\$660
SRM2442LG18	24 x 42 x 29	150	91	19.58	\$686
SRM2448LG18	24 x 48 x 29	150	96.50	22.28	\$713
SRM2454LG18	24 x 54 x 29	150	110	24.98	\$740
SRM2460LG18	24 x 60 x 29	150	115.50	27.68	\$766
SRM2466LG18	24 x 66 x 29	250	120	30.38	\$784
SRM2472LG18	24 x 72 x 29	150	134.50	33.08	\$796

SRM2430LG26	24 x 30 x 29	150	82	14.18	\$639
SRM2436LG26	24 x 36 x 29	150	83	16.88	\$667
SRM2442LG26	24 x 42 x 29	150	94	19.58	\$694
SRM2448LG26	24 x 48 x 29	150	100	22.28	\$722
SRM2454LG26	24 x 54 x 29	150	114	24.98	\$750
SRM2460LG26	24 x 60 x 29	150	120	27.68	\$778
SRM2466LG26	24 x 66 x 29	150	125.50	30.38	\$796
SRM2472LG26	24 x 72 x 29	150	140	33.08	\$810

- SRM24xxLG18 has an 18" modesty panel
- SRM24xxLG26 has a 26" modesty panel

SRM2430RG18	24 x 30 x 29	150	80	14.18	\$633
SRM2436RG18	24 x 36 x 29	125	120	20	\$660
SRM2442RG18	24 x 42 x 29	150	91	19.58	\$686
SRM2448RG18	24 x 48 x 29	150	96.50	22.28	\$713
SRM2454RG18	24 x 54 x 29	150	110	24.98	\$740
SRM2460RG18	24 x 60 x 29	150	115.50	27.68	\$766
SRM2466RG18	24 x 66 x 29	250	120	30.38	\$784
SRM2472RG18	24 x 72 x 29	150	134.50	33.08	\$796

SRM2430RG26	24 x 30 x 29	150	82	14.18	\$639
SRM2436RG26	24 x 36 x 29	150	83	16.88	\$667
SRM2442RG26	24 x 42 x 29	150	94	19.58	\$694
SRM2448RG26	24 x 48 x 29	150	100	22.28	\$722
SRM2454RG26	24 x 54 x 29	150	114	24.98	\$750
SRM2460RG26	24 x 60 x 29	150	120	27.68	\$778
SRM2466RG26	24 x 66 x 29	150	125.50	30.38	\$796
SRM2472RG26	24 x 72 x 29	150	140	33.08	\$810

- SRM24xxRG18 has an 18" modesty panel
- SRM24xxRG26 has a 26" modesty panel

Required Specifications

Top Finish
Body Finish

Optional Specifications

Grommet

RETURNS

MODEL# DIMENSIONS FREIGHT CLASS WT/LBS. CUBIC FT. LIST PRICE

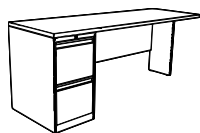

18" modesty

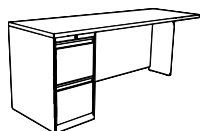

26" modesty

Return - Left

D x W x H						
SRM2430LF18	24 x 30 x 29	100	117.50	14.18	\$851	
SRM2436LF18	24 x 36 x 29	125	123	16.88	\$877	
SRM2442LF18	24 x 42 x 29	125	128.50	19.58	\$904	
SRM2448LF18	24 x 48 x 29	150	135	24	\$931	
SRM2454LF18	24 x 54 x 29	150	147.50	24.98	\$957	
SRM2460LF18	24 x 60 x 29	150	153	27.68	\$984	
SRM2466LF18	24 x 66 x 29	150	158	30.38	\$1001	
SRM2472LF18	24 x 72 x 29	150	172	33.08	\$1014	
SRM2430LF26	24 x 30 x 29	100	120	14.18	\$856	
SRM2436LF26	24 x 36 x 29	125	126	16.88	\$884	
SRM2442LF26	24 x 42 x 29	125	132	19.58	\$912	
SRM2448LF26	24 x 48 x 29	125	138	22.28	\$940	
SRM2454LF26	24 x 54 x 29	125	152	24.98	\$968	
SRM2460LF26	24 x 60 x 29	150	157.90	27.68	\$995	
SRM2466LF26	24 x 66 x 29	150	163	30.38	\$1014	
SRM2472LF26	24 x 72 x 29	150	178	33.08	\$1028	

Standard with full to floor **file/file** pedestal on **left**. Pedestal lock.

- SRM24xxLF18 has an 18" modesty panel
- SRM24xxLF26 has a 26" modesty panel

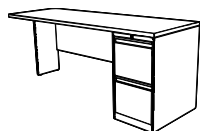

18" modesty

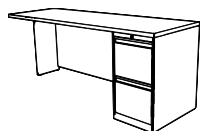

26" modesty

Return - Right

SRM2430RF18	24 x 30 x 29	100	117.50	14.18	\$851	
SRM2436RF18	24 x 36 x 29	125	123	16.88	\$877	
SRM2442RF18	24 x 42 x 29	125	128.50	19.58	\$904	
SRM2448RF18	24 x 48 x 29	150	135	24	\$931	
SRM2454RF18	24 x 54 x 29	150	147.50	24.98	\$957	
SRM2460RF18	24 x 60 x 29	150	153	27.68	\$984	
SRM2466RF18	24 x 66 x 29	150	158	30.38	\$1001	
SRM2472RF18	24 x 72 x 29	150	172	33.08	\$1014	
SRM2430RF26	24 x 30 x 29	100	120	14.18	\$856	
SRM2436RF26	24 x 36 x 29	125	126	16.88	\$884	
SRM2442RF26	24 x 42 x 29	125	132	19.58	\$912	
SRM2448RF26	24 x 48 x 29	125	138	22.28	\$940	
SRM2454RF26	24 x 54 x 29	125	152	24.98	\$968	
SRM2460RF26	24 x 60 x 29	150	157.90	27.68	\$995	
SRM2466RF26	24 x 66 x 29	150	163	30.38	\$1014	
SRM2472RF26	24 x 72 x 29	150	178	33.08	\$1028	

Standard with full to floor **file/file** pedestal on **right**. Pedestal lock.

- SRM24xxRF18 has an 18" modesty panel
- SRM24xxRF26 has a 26" modesty panel.

Required Specifications

Top Finish
Body Finish

Optional Specifications

Grommet

RETURNS



18" modesty



26" modesty

Return - Left

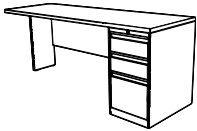

18" modesty



26" modesty

Return - Right

MODEL#	DIMENSIONS	FREIGHT CLASS	WT/LBS.	CUBIC FT.	LIST PRICE
--------	------------	---------------	---------	-----------	------------

D x W x H

SRM2430LB18	24 x 30 x 29	100	117.50	14.18	\$851
SRM2436LB18	24 x 36 x 29	125	123	16.88	\$877
SRM2442LB18	24 x 42 x 29	125	128.50	19.58	\$904
SRM2448LB18	24 x 48 x 29	150	135	24	\$931
SRM2454LB18	24 x 54 x 29	150	147.50	24.98	\$957
SRM2460LB18	24 x 60 x 29	150	153	27.68	\$984
SRM2466LB18	24 x 66 x 29	150	158	30.38	\$1001
SRM2472LB18	24 x 72 x 29	150	172	33.08	\$1014

SRM2430LB26	24 x 30 x 29	100	120	14.18	\$856
SRM2436LB26	24 x 36 x 29	125	126	16.88	\$884
SRM2442LB26	24 x 42 x 29	125	132	19.58	\$912
SRM2448LB26	24 x 48 x 29	125	138	22.28	\$940
SRM2454LB26	24 x 54 x 29	125	152	24.98	\$968
SRM2460LB26	24 x 60 x 29	150	157.90	27.68	\$995
SRM2466LB26	24 x 66 x 29	150	163	30.38	\$1014
SRM2472LB26	24 x 72 x 29	150	178	33.08	\$1028

Standard with full to floor **box/box/file** pedestal on **left**. Pedestal lock. One pencil tray.

- SRM24xxLB18 has an 18" modesty panel
- SRM24xxLB26 has a 26" modesty panel.

SRM2430RB18	24 x 30 x 29	100	117.50	14.18	\$851
SRM2436RB18	24 x 36 x 29	125	123	16.88	\$877
SRM2442RB18	24 x 42 x 29	125	128.50	19.58	\$904
SRM2448RB18	24 x 48 x 29	150	135	24	\$931
SRM2454RB18	24 x 54 x 29	150	147.50	24.98	\$957
SRM2460RB18	24 x 60 x 29	150	153	27.68	\$984
SRM2466RB18	24 x 66 x 29	150	158	30.38	\$1001
SRM2472RB18	24 x 72 x 29	150	172	33.08	\$1014

SRM2430RB26	24 x 30 x 29	100	120	14.18	\$856
SRM2436RB26	24 x 36 x 29	125	126	16.88	\$884
SRM2442RB26	24 x 42 x 29	125	132	19.58	\$912
SRM2448RB26	24 x 48 x 29	125	138	22.28	\$940
SRM2454RB26	24 x 54 x 29	125	152	24.98	\$968
SRM2460RB26	24 x 60 x 29	150	157.90	27.68	\$995
SRM2466RB26	24 x 66 x 29	150	163	30.38	\$1014
SRM2472RB26	24 x 72 x 29	150	178	33.08	\$1028

Standard with full to floor **box/box/file** pedestal on **right**. Pedestal lock. One pencil tray.

- SRM24xxRB18 has an 18" modesty panel
- SRM24xxRB26 has a 26" modesty panel

Required Specifications

Top Finish
Body Finish

Optional Specifications

Grommet

RETURNS

MODEL# DIMENSIONS FREIGHT CLASS WT/LBS. CUBIC FT. LIST PRICE

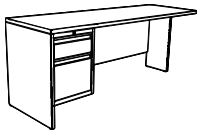

20" modesty



26" modesty

Return - Left

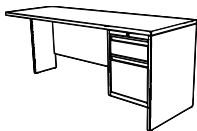

20" modesty

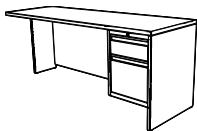

26" modesty

Return - Right

		D x W x H					
SRM2430LH20	24 x 30 x 29	100	119.50	14.18	\$832		
SRM2436LH20	24 x 36 x 29	125	125	16.88	\$859		
SRM2442LH20	24 x 42 x 29	125	130.50	19.58	\$885		
SRM2448LH20	24 x 48 x 29	125	136	22.28	\$912		
SRM2454LH20	24 x 54 x 29	150	149.50	24.98	\$939		
SRM2460LH20	24 x 60 x 29	150	155	27.68	\$965		
SRM2466LH20	24 x 66 x 29	150	160	30.38	\$983		
SRM2472LH20	24 x 72 x 29	150	174	33.08	\$995		
SRM2430LH26	24 x 30 x 29	100	122	14.18	\$838		
SRM2436LH26	24 x 36 x 29	125	128	16.88	\$866		
SRM2442LH26	24 x 42 x 29	125	134	19.58	\$894		
SRM2448LH26	24 x 48 x 29	125	140	22.28	\$921		
SRM2454LH26	24 x 54 x 29	125	154	24.98	\$949		
SRM2460LH26	24 x 60 x 29	150	160	27.68	\$977		
SRM2466LH26	24 x 66 x 29	150	165	30.38	\$995		
SRM2472LH26	24 x 72 x 29	150	180	33.08	\$1009		

Standard with **box/file** pedestal on **left**. Pedestal lock. One pencil tray.

- SRM24xxLH20 has a 20" modesty panel
- SRM24xxLH26 has a 26" modesty panel

SRM2430RH20	24 x 30 x 29	100	119.50	14.18	\$832		
SRM2436RH20	24 x 36 x 29	125	125	16.88	\$859		
SRM2442RH20	24 x 42 x 29	125	130.50	19.58	\$885		
SRM2448RH20	24 x 48 x 29	125	136	22.28	\$912		
SRM2454RH20	24 x 54 x 29	150	149.50	24.98	\$939		
SRM2460RH20	24 x 60 x 29	150	155	27.68	\$965		
SRM2466RH20	24 x 66 x 29	150	160	30.38	\$983		
SRM2472RH20	24 x 72 x 29	150	174	33.08	\$995		
SRM2430RH26	24 x 30 x 29	100	122	14.18	\$838		
SRM2436RH26	24 x 36 x 29	125	128	16.88	\$866		
SRM2442RH26	24 x 42 x 29	125	134	19.58	\$894		
SRM2448RH26	24 x 48 x 29	125	140	22.28	\$921		
SRM2454RH26	24 x 54 x 29	125	154	24.98	\$949		
SRM2460RH26	24 x 60 x 29	150	160	27.68	\$977		
SRM2466RH26	24 x 66 x 29	150	165	30.38	\$995		
SRM2472RH26	24 x 72 x 29	150	180	33.08	\$1009		

Standard with **box/file** pedestal on **right**. Pedestal lock. One pencil tray.

- SRM24xxRH20 has a 20" modesty panel
- SRM24xxRH26 has a 26" modesty panel

Required Specifications

Top Finish
Body Finish

Optional Specifications

Grommet

SPACE SAVER RETURNS

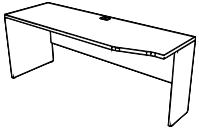

18" modesty

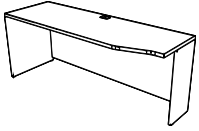

26" modesty

24" D Space Saver Return, Left

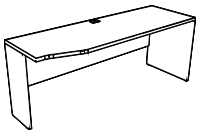

18" modesty

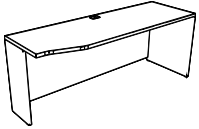

26" modesty

24" D Space Saver Return, Right

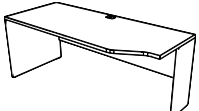

18" modesty

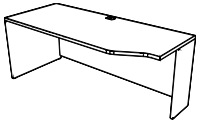

26" modesty

30" D Space Saver Return, Left

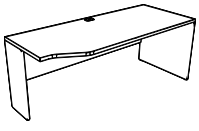

18" modesty

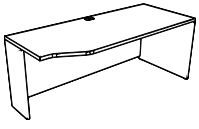

26" modesty

30" D Space Saver Return, Right

MODEL#	DIMENSIONS	FREIGHT CLASS	WT./LBS.	CUBIC FT.	LIST PRICE
--------	------------	---------------	----------	-----------	------------

D x W x H

SDM244820LK18	24 x 48 x 29	150	94.50	22.28	\$877
SDM245420LK18	24 x 54 x 29	150	108	24.98	\$891
SDM246020LK18	24 x 60 x 29	150	113.50	27.68	\$905
SDM246620LK18	24 x 66 x 29	250	118	30.38	\$932
SDM247220LK18	24 x 72 x 29	150	132.50	33.08	\$963

SDM244820LK26	24 x 48 x 29	150	98	22.28	\$889
SDM245420LK26	24 x 54 x 29	150	112	24.98	\$903
SDM246020LK26	24 x 60 x 29	150	118	27.68	\$917
SDM246620LK26	24 x 66 x 29	150	123.50	30.38	\$944
SDM247220LK26	24 x 72 x 29	150	138	33.08	\$977

Connects to **20" D 5-sided** corner unit. Grommet in worksurface.

- SDM24xx20LK18 has an 18" modesty panel
- SDM24xx20LK26 has a 26" modesty panel

SDM244820RK18	24 x 48 x 29	150	94.50	22.28	\$877
SDM245420RK18	24 x 54 x 29	150	108	24.98	\$891
SDM246020RK18	24 x 60 x 29	150	113.50	27.68	\$905
SDM246620RK18	24 x 66 x 29	250	118	30.38	\$932
SDM247220RK18	24 x 72 x 29	150	132.50	33.08	\$963

SDM244820RK26	24 x 48 x 29	150	98	22.28	\$889
SDM245420RK26	24 x 54 x 29	150	112	24.98	\$903
SDM246020RK26	24 x 60 x 29	150	118	27.68	\$917
SDM246620RK26	24 x 66 x 29	150	123.50	30.38	\$944
SDM247220RK26	24 x 72 x 29	150	138	33.08	\$977

Connects to **20" D 5-sided** corner unit. Grommet in worksurface.

- SDM24xx20RK18 has an 18" modesty panel
- SDM24xx20RK26 has a 26" modesty panel

SDM306024LK18	24 x 60 x 29	150	142	34.19	\$942
SDM306624LK18	24 x 66 x 29	150	151.50	37.53	\$968
SDM307224LK18	24 x 72 x 29	250	163	40.87	\$1037

SDM306024LK26	24 x 60 x 29	150	146.50	34.19	\$954
SDM306624LK26	24 x 66 x 29	150	158	37.53	\$981
SDM307224LK26	24 x 72 x 29	150	169	40.87	\$1051

Connects to **24" D 5-sided** corner unit. Grommet in worksurface.

- SDM30xx24LK18 has an 18" modesty panel
- SDM30xx24LK26 has a 26" modesty panel

SDM306024RK18	24 x 60 x 29	150	142	34.19	\$942
SDM306624RK18	24 x 66 x 29	150	151.50	37.53	\$968
SDM307224RK18	24 x 72 x 29	250	163	40.87	\$1037

SDM306024RK26	24 x 60 x 29	150	146.50	34.19	\$954
SDM306624RK26	24 x 66 x 29	150	158	37.53	\$981
SDM307224RK26	24 x 72 x 29	150	169	40.87	\$1051

Connects to **24" D 5-sided** corner unit. Grommet in worksurface.

- SDM30xx24RK18 has an 18" modesty panel
- SDM30xx24RK26 has a 26" modesty panel

Required Specifications

Top Finish
Body Finish

Optional Specifications

Grommet

SPACE SAVER RETURNS

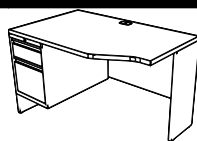

20" modesty

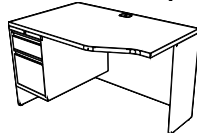

26" modesty

30" D Space Saver Return, Left

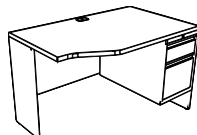

20" modesty

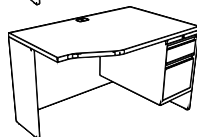

26" modesty

30" D Space Saver Return, Right

MODEL# DIMENSIONS FREIGHT CLASS WT./LBS. CUBIC FT. LIST PRICE

D x W x H

SDM304824HLK20	24 x 48 x 29	150	147.50	27.50	\$1236
SDM304824HLK26	24 x 48 x 29	150	151.50	27.50	\$1245

Standard with **box/file** pedestal on **left**. Pedestal lock. One pencil tray.

- SDM304824HLK20 has a 20" modesty panel
- SDM304824HLK26 has a 26" modesty panel

SDM304824HRK20	24 x 48 x 29	150	147.50	27.50	\$1236
SDM304824HRK26	24 x 48 x 29	150	151.50	27.50	\$1245

Standard with **box/file** pedestal on **right**. Pedestal lock. One pencil tray.

- SDM304824HRK20 has a 20" modesty panel
- SDM304824HRK26 has a 26" modesty panel

DOUBLE PEDESTAL CRENZAS

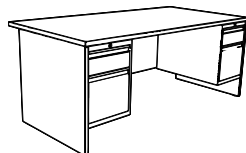

20" modesty

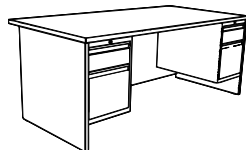

26" modesty

Double Pedestal Credenza



18" modesty



26" modesty

Double Pedestal Credenza

SDM2448HH20	24 x 48 x 29	100	188	22.28	\$1324
SDM2454HH20	24 x 54 x 29	100	201.50	24.98	\$1351
SDM2460HH20	24 x 60 x 29	125	207	27.68	\$1377
SDM2466HH20	24 x 66 x 29	125	211.50	30.38	\$1395
SDM2472HH20	24 x 72 x 29	125	226	33.08	\$1407

SDM2448HH26	24 x 48 x 29	100	192	22.28	\$1333
SDM2454HH26	24 x 54 x 29	100	206	24.98	\$1361
SDM2460HH26	24 x 60 x 29	125	212	27.68	\$1389
SDM2466HH26	24 x 66 x 29	125	217	30.38	\$1407
SDM2472HH26	24 x 72 x 29	125	232	33.08	\$1421

Standard with **box/file** pedestals on both sides. Pedestal locks. One pencil tray.

- SDM24xxHH20 has a 20" modesty panel
- SDM24xxHH26 has a 26" modesty panel

SDM2448BB18	24 x 48 x 29	100	184	22.28	\$1213
SDM2454BB18	24 x 54 x 29	125	197.50	24.98	\$1240
SDM2460BB18	24 x 60 x 29	125	203	27.68	\$1266
SDM2466BB18	24 x 66 x 29	125	208	30.38	\$1284
SDM2472BB18	24 x 72 x 29	125	222	33.08	\$1296

SDM2448BB26	24 x 48 x 29	100	188	22.28	\$1222
SDM2454BB26	24 x 54 x 29	100	202	24.98	\$1250
SDM2460BB26	24 x 60 x 29	125	208	27.68	\$1278
SDM2466BB26	24 x 66 x 29	125	213	30.38	\$1296
SDM2472BB26	24 x 72 x 29	125	228	33.08	\$1310

Standard with full to floor **box/box/file** pedestals on both sides. Pedestal locks. One pencil tray.

- SDM24xxBB18 has an 18" modesty panel
- SDM24xxBB26 has a 26" modesty panel

Required Specifications

Top Finish
Body Finish

Optional Specifications

Grommet

DOUBLE PEDESTAL DESKS

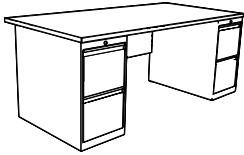

18" modesty

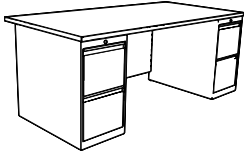

26" modesty

Double Pedestal Credenza

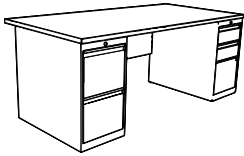

18" modesty

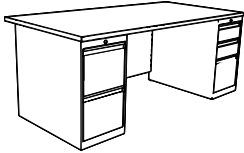

26" modesty

Double Pedestal Credenza

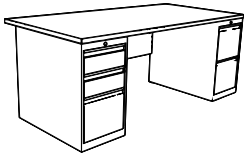

18" modesty



26" modesty

Double Pedestal Credenza

MODEL#	DIMENSIONS	FREIGHT CLASS	WT/LBS.	CUBIC FT.	LIST PRICE
--------	------------	---------------	---------	-----------	------------

D x W x H

SDM2448FF18	24 x 48 x 29	100	184	22.28	\$1213
SDM2454FF18	24 x 54 x 29	125	197.50	24.98	\$1240
SDM2460FF18	24 x 60 x 29	125	203	27.68	\$1266
SDM2466FF18	24 x 66 x 29	125	208	30.38	\$1284
SDM2472FF18	24 x 72 x 29	125	222	33.08	\$1296
SDM2448FF26	24 x 48 x 29	100	188	22.28	\$1222
SDM2454FF26	24 x 54 x 29	100	202	24.98	\$1250
SDM2460FF26	24 x 60 x 29	125	208	27.68	\$1278
SDM2466FF26	24 x 66 x 29	125	213	30.38	\$1296
SDM2472FF26	24 x 72 x 29	125	228	33.08	\$1310

Standard with full to floor **file/file** pedestals on both sides. Pedestal locks.

- SDM24xxFF18 has an 18" modesty panel
- SDM24xxFF26 has a 26" modesty panel

SDM2448FB18	24 x 48 x 29	100	184	22.28	\$1213
SDM2454FB18	24 x 54 x 29	125	197.50	24.98	\$1240
SDM2460FB18	24 x 60 x 29	125	203	27.68	\$1266
SDM2466FB18	24 x 66 x 29	125	208	30.38	\$1284
SDM2472FB18	24 x 72 x 29	125	222	33.08	\$1296

SDM2448FB26	24 x 48 x 29	100	188	22.28	\$1222
SDM2454FB26	24 x 54 x 29	100	202	24.98	\$1250
SDM2460FB26	24 x 60 x 29	125	208	27.68	\$1278
SDM2466FB26	24 x 66 x 29	125	213	30.38	\$1296
SDM2472FB26	24 x 72 x 29	125	228	33.08	\$1310

Standard with full to floor **file/file** pedestal on **left** and **box/box/file** pedestal on **right**. Pedestal locks. One pencil tray.

- SDM24xxFB18 has an 18" modesty panel
- SDM24xxFB26 has a 26" modesty panel.

SDM2448BF18	24 x 48 x 29	100	184	22.28	\$1213
SDM2454BF18	24 x 54 x 29	125	197.50	24.98	\$1240
SDM2460BF18	24 x 60 x 29	125	203	27.68	\$1266
SDM2466BF18	24 x 66 x 29	125	208	30.38	\$1284
SDM2472BF18	24 x 72 x 29	125	222	33.08	\$1296

SDM2448BF26	24 x 48 x 29	100	188	22.28	\$1222
SDM2454BF26	24 x 54 x 29	100	202	24.98	\$1250
SDM2460BF26	24 x 60 x 29	125	208	27.68	\$1278
SDM2466BF26	24 x 66 x 29	125	213	30.38	\$1296
SDM2472BF26	24 x 72 x 29	125	228	33.08	\$1310

Standard with full to floor **file/file** pedestal on **right** and **box/box/file** pedestal on **left**. Pedestal locks. One pencil tray.

- SDM24xxBF18 has an 18" modesty panel
- SDM24xxBF26 has a 26" modesty panel

Required Specifications

Top Finish
Body Finish

Optional Specifications

Grommet

SINGLE PEDESTAL DESKS

MODEL# DIMENSIONS FREIGHT CLASS WT/LBS. CUBIC FT. LIST PRICE

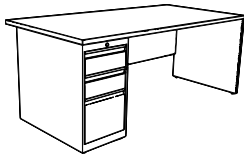

18" modesty



26" modesty

Single Pedestal Credenza - Left

D x W x H						
SDM2430BG18	24 x 30 x 29	100	129.50	14.18	\$897	
SDM2436BG18	24 x 36 x 29	125	135	16.88	\$924	
SDM2442BG18	24 x 42 x 29	125	140.50	19.58	\$950	
SDM2448BG18	24 x 48 x 29	125	146	22.28	\$977	
SDM2454BG18	24 x 54 x 29	125	160	24.98	\$1003	
SDM2460BG18	24 x 60 x 29	150	165	27.68	\$1030	
SDM2466BG18	24 x 66 x 29	150	170	30.38	\$1047	
SDM2472BG18	24 x 72 x 29	150	184	33.08	\$1060	
SDM2430BG26	24 x 30 x 29	100	132	14.18	\$903	
SDM2436BG26	24 x 36 x 29	100	138	16.88	\$931	
SDM2442BG26	24 x 42 x 29	125	144	19.58	\$958	
SDM2448BG26	24 x 48 x 29	125	150	22.28	\$986	
SDM2454BG26	24 x 54 x 29	125	164	24.98	\$1014	
SDM2460BG26	24 x 60 x 29	125	170	27.68	\$1042	
SDM2466BG26	24 x 66 x 29	150	175	30.38	\$1060	
SDM2472BG26	24 x 72 x 29	150	190	33.08	\$1074	

Standard with full to floor **box/box/file** pedestal on **left**. Pedestal lock. One pencil tray.

- SDM24xxBG18 has an 18" modesty panel
- SDM24xxBG26 has a 26" modesty panel

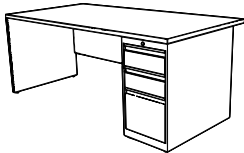

18" modesty

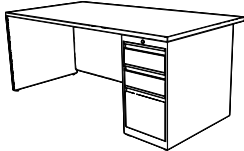

26" modesty

Single Pedestal Credenza - Right

SDM2430GB18	24 x 30 x 29	100	129.50	14.18	\$897	
SDM2436GB18	24 x 36 x 29	125	135	16.88	\$924	
SDM2442GB18	24 x 42 x 29	125	140.50	19.58	\$950	
SDM2448GB18	24 x 48 x 29	125	146	22.28	\$977	
SDM2454GB18	24 x 54 x 29	125	160	24.98	\$1003	
SDM2460GB18	24 x 60 x 29	150	165	27.68	\$1030	
SDM2466GB18	24 x 66 x 29	150	170	30.38	\$1047	
SDM2472GB18	24 x 72 x 29	150	184	33.08	\$1060	
SDM2430GB26	24 x 30 x 29	100	132	14.18	\$903	
SDM2436GB26	24 x 36 x 29	100	138	16.88	\$931	
SDM2442GB26	24 x 42 x 29	125	144	19.58	\$958	
SDM2448GB26	24 x 48 x 29	125	150	22.28	\$986	
SDM2454GB26	24 x 54 x 29	125	164	24.98	\$1014	
SDM2460GB26	24 x 60 x 29	125	170	27.68	\$1042	
SDM2466GB26	24 x 66 x 29	150	175	30.38	\$1060	
SDM2472GB26	24 x 72 x 29	150	190	33.08	\$1074	

Standard with full to floor **box/box/file** pedestal on **right**. Pedestal lock. One pencil tray.

- SDM24xxGB18 has an 18" modesty panel
- SDM24xxGB26 has a 26" modesty panel

Required Specifications

Top Finish
Body Finish

Optional Specifications

Grommet

SINGLE PEDESTAL DESKS

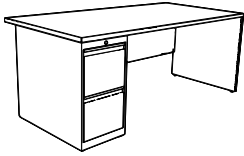

18" modesty

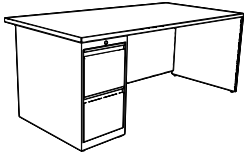

26" modesty

Single Pedestal Credenza - Left

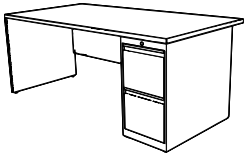

18" modesty

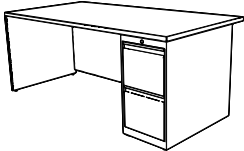

26" modesty

Single Pedestal Credenza - Right

MODEL#	DIMENSIONS	FREIGHT CLASS	WT/LBS.	CUBIC FT.	LIST PRICE
--------	------------	---------------	---------	-----------	------------

D x W x H

SDM2430FG18	24 x 30 x 29	100	129.50	14.18	\$897
SDM2436FG18	24 x 36 x 29	125	135	16.88	\$924
SDM2442FG18	24 x 42 x 29	125	140.50	19.58	\$950
SDM2448FG18	24 x 48 x 29	125	146	22.28	\$977
SDM2454FG18	24 x 54 x 29	125	160	24.98	\$1003
SDM2460FG18	24 x 60 x 29	150	165	27.68	\$1030
SDM2466FG18	24 x 66 x 29	150	170	30.38	\$1047
SDM2472FG18	24 x 72 x 29	150	184	33.08	\$1060
SDM2430FG26	24 x 30 x 29	100	132	14.18	\$903
SDM2436FG26	24 x 36 x 29	100	138	16.88	\$931
SDM2442FG26	24 x 42 x 29	125	144	19.58	\$958
SDM2448FG26	24 x 48 x 29	125	150	22.28	\$986
SDM2454FG26	24 x 54 x 29	125	164	24.98	\$1014
SDM2460FG26	24 x 60 x 29	125	170	27.68	\$1042
SDM2466FG26	24 x 66 x 29	150	165.50	30.38	\$1060
SDM2472FG26	24 x 72 x 29	150	190	33.08	\$1074

Standard with full to floor **file/file** pedestal on **left**. Pedestal lock. One pencil tray.

- SDM24xxFG18 has an 18" modesty panel
- SDM24xxFG26 has a 26" modesty panel

SDM2430GF18	24 x 30 x 29	100	129.50	14.18	\$897
SDM2436GF18	24 x 36 x 29	125	135	16.88	\$924
SDM2442GF18	24 x 42 x 29	125	140.50	19.58	\$950
SDM2448GF18	24 x 48 x 29	125	146	22.28	\$977
SDM2454GF18	24 x 54 x 29	125	160	24.98	\$1003
SDM2460GF18	24 x 60 x 29	150	165	27.68	\$1030
SDM2466GF18	24 x 66 x 29	150	170	30.38	\$1047
SDM2472GF18	24 x 72 x 29	150	184	33.08	\$1060
SDM2430GF26	24 x 30 x 29	100	132	14.18	\$903
SDM2436GF26	24 x 36 x 29	100	138	16.88	\$931
SDM2442GF26	24 x 42 x 29	125	144	19.58	\$958
SDM2448GF26	24 x 48 x 29	125	150	22.28	\$986
SDM2454GF26	24 x 54 x 29	125	164	24.98	\$1014
SDM2460GF26	24 x 60 x 29	125	170	27.68	\$1042
SDM2466GF26	24 x 66 x 29	150	175	30.38	\$1060
SDM2472GF26	24 x 72 x 29	150	190	33.08	\$1074

Standard with full to floor **file/file** pedestal on **right**. Pedestal lock. One pencil tray.

- SDM24xxGF18 has an 18" modesty panel
- SDM24xxGF26 has a 26" modesty panel

Required Specifications

Top Finish
Body Finish

Optional Specifications

Grommet

SINGLE PEDESTAL DESKS

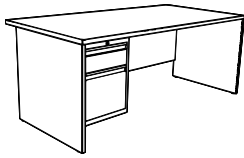

20" modesty



26" modesty

Single Pedestal Credenza - Left

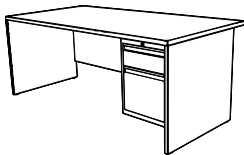

20" modesty

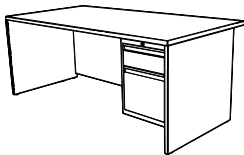

26" modesty

Single Pedestal Credenza - Right

MODEL# DIMENSIONS FREIGHT CLASS WT/LBS. CUBIC FT. LIST PRICE

D x W x H

SDM2430HG20	24 x 30 x 29	100	131.50	14.18	\$953
SDM2436HG20	24 x 36 x 29	100	137	16.88	\$979
SDM2442HG20	24 x 42 x 29	125	143	19.58	\$1006
SDM2448HG20	24 x 48 x 29	125	148	22.28	\$1032
SDM2454HG20	24 x 54 x 29	125	161.50	24.98	\$1059
SDM2460HG20	24 x 60 x 29	125	167	27.68	\$1086
SDM2466HG20	24 x 66 x 29	150	172	30.38	\$1103
SDM2472HG20	24 x 72 x 29	150	186	33.08	\$1116

SDM2430HG26	24 x 30 x 29	100	134	14.18	\$958
SDM2436HG26	24 x 36 x 29	100	140	16.88	\$986
SDM2442HG26	24 x 42 x 29	125	146	19.58	\$1014
SDM2448HG26	24 x 48 x 29	125	152	22.28	\$1042
SDM2454HG26	24 x 54 x 29	125	166	24.98	\$1069
SDM2460HG26	24 x 60 x 29	125	172	27.68	\$1097
SDM2466HG26	24 x 66 x 29	150	177	30.38	\$1116
SDM2472HG26	24 x 72 x 29	150	192	33.08	\$1130

Standard with **box/file** pedestal on **left**. Pedestal lock. One pencil tray.

- SDM24xxHG20 has a 20" modesty panel
- SDM24xxHG26 has a 26" modesty panel

SDM2430GH20	24 x 30 x 29	100	131.50	14.18	\$953
SDM2436GH20	24 x 36 x 29	100	137	16.88	\$979
SDM2442GH20	24 x 42 x 29	125	143	19.58	\$1006
SDM2448GH20	24 x 48 x 29	125	148	22.28	\$1032
SDM2454GH20	24 x 54 x 29	125	161.50	24.98	\$1059
SDM2460GH20	24 x 60 x 29	125	167	27.68	\$1086
SDM2466GH20	24 x 66 x 29	150	172	30.38	\$1103
SDM2472GH20	24 x 72 x 29	150	186	33.08	\$1116

SDM2430GH26	24 x 30 x 29	100	134	14.18	\$958
SDM2436GH26	24 x 36 x 29	100	140	16.88	\$986
SDM2442GH26	24 x 42 x 29	125	146	19.58	\$1014
SDM2448GH26	24 x 48 x 29	125	152	22.28	\$1042
SDM2454GH26	24 x 54 x 29	125	166	24.98	\$1069
SDM2460GH26	24 x 60 x 29	125	172	27.68	\$1097
SDM2466GH26	24 x 66 x 29	150	177	30.38	\$1116
SDM2472GH26	24 x 72 x 29	150	192	33.08	\$1130

Standard with **box/file** pedestal on **right**. Pedestal lock. One pencil tray.

- SDM24xxGH20 has a 20" modesty panel
- SDM24xxGH26 has a 26" modesty panel

Required Specifications

Top Finish
Body Finish

Optional Specifications

Grommet

S STREAMLINE II™

CREDENZAS

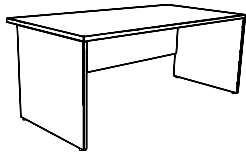

18" modesty

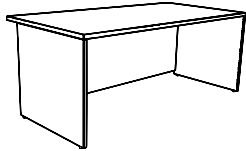

26" modesty

Credenza Shell

MODEL#	DIMENSIONS D x W x H	FREIGHT CLASS	WT./LBS.	CUBIC FT.	LIST PRICE
SDM2430GG18	24 x 30 x 29	125	92	14.18	\$661
SDM2436GG18	24 x 36 x 29	150	97.50	16.88	\$688
SDM2442GG18	24 x 42 x 29	150	103	19.58	\$714
SDM2448GG18	24 x 48 x 29	150	108	22.28	\$741
SDM2454GG18	24 x 54 x 29	150	122	24.98	\$767
SDM2460GG18	24 x 60 x 29	150	127.50	27.68	\$794
SDM2466GG18	24 x 66 x 29	150	170	30.38	\$811
SDM2472GG18	24 x 72 x 29	150	146.50	33.08	\$824
SDM2430GG26	24 x 30 x 29	125	94	14.18	\$667
SDM2436GG26	24 x 36 x 29	150	100	16.88	\$694
SDM2442GG26	24 x 42 x 29	150	106	19.58	\$722
SDM2448GG26	24 x 48 x 29	150	112	22.28	\$750
SDM2454GG26	24 x 54 x 29	150	126	24.98	\$778
SDM2460GG26	24 x 60 x 29	150	132	27.68	\$806
SDM2466GG26	24 x 66 x 29	150	175	30.38	\$824
SDM2472GG26	24 x 72 x 29	150	152	33.08	\$838

- SDM24xxGG18 has an 18" modesty panel
- SDM24xxGG26 has a 26" modesty panel

HUTCHES

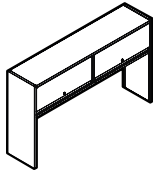

Closed Hutch with Open Back

SH1572	15 x 72 x 39	125	115	14.50	\$861
SH1566	15 x 66 x 39	100	110	13	\$836
SH1560	15 x 60 x 39	100	105	12	\$806
SH1548	15 x 48 x 39	100	95	10	\$780
SH1542	15 x 42 x 39	100	85	9	\$746
SH1536	15 x 36 x 39	92.5	75	7.50	\$727

Hutch with two receding doors and one fixed shelf divider. **ALL METAL.** Doors lock. Not slotted for plate dividers. Shipped RTA (ready to assemble).

- Models SH1542/SH1536 use a single receding door and no shelf divider.

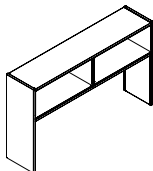

Open Hutch with Open Back

SH1572ND	15 x 72 x 39.62	125	115	14.50	\$729
SH1566ND	15 x 66 x 39.62	100	115	13	\$707
SH1560ND	15 x 60 x 39.62	100	115	12	\$683
SH1548ND	15 x 48 x 39.62	92.5	115	10	\$667
SH1542ND	15 x 42 x 39.62	85	115	9	\$633
SH1536ND	15 x 36 x 39.62	70	115	7.50	\$617

One fixed shelf and one fixed shelf divider. **ALL METAL.** Not slotted for plate dividers. Shipped RTA (ready to assemble).

BACK PANELS

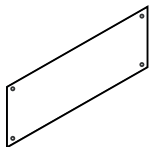

Back Panel

SHM72	.75 x 72 x 24	65	33	1.30	\$415
SHM66	.75 x 66 x 24	65	31	1.20	\$396
SHM60	.75 x 60 x 24	65	28	1	\$377
SHM48	.75 x 48 x 24	60	24	.80	\$342
SHM42	.75 x 42 x 24	65	21	.75	\$327
SHM36	.75 x 36 x 24	60	19	.60	\$313

For StreamLINE Series Hutches Only. **ALL METAL.**

Required Specifications

Top Finish
Body Finish

Optional Specifications

Grommet (Credenza Shells)

TACKBOARDS FOR HUTCHES

MODEL# DIMENSIONS FREIGHT CLASS WT./LBS. CUBIC FT. FABRIC GRADE LIST PRICE

D x W x H

BACK PANEL Notes: Tackboards can be upholstered in all of the following fabrics:

Grade 1: Agate II, Drama, Jenny, Pebbles, Quilt, Sprinkle, Station, Urban

Grade 2: Couture, Crescent, Cumulus, Imprint, Lola, Match, Oxygen, Quantum, Renewal, Replay, Silhouette

Grade 3: Brinx, Mariposa

Grade 4: Accent

Grade 5: Meander, Tracery, Universe

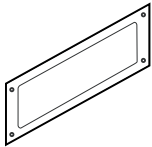

Back Panel

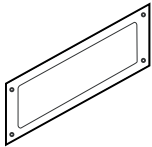

Back Panel

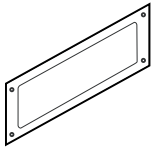

Back Panel

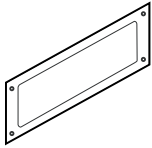

Back Panel

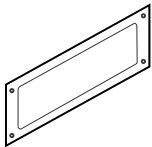

Back Panel

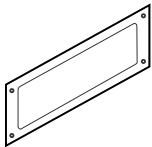

Back Panel

SHMTB72	.75 x 72 x 24	65	33	1.30	1	\$556
					2	\$609
					3	\$671
					4	\$745
					5	\$745

For StreamLINE Series Hutches Only. **ALL METAL** with tackboard.

SHMTB66	.75 x 66 x 24	65	31	1.20	1	\$476
					2	\$523
					3	\$572
					4	\$627
					5	\$697

For StreamLINE Series Hutches Only. **ALL METAL** with tackboard.

SHMTB60	.75 x 60 x 24	65	28	1	1	\$449
					2	\$493
					3	\$535
					4	\$586
					5	\$646

For StreamLINE Series Hutches Only. **ALL METAL** with tackboard.

SHMTB48	.75 x 48 x 24	60	24	.80	1	\$405
					2	\$438
					3	\$470
					4	\$509
					5	\$544

For StreamLINE Series Hutches Only. **ALL METAL** with tackboard.

SHMTB42	.75 x 42 x 24	65	21	.75	1	\$383
					2	\$412
					3	\$442
					4	\$479
					5	\$521

For StreamLINE Series Hutches Only. **ALL METAL** with tackboard.

SHMTB36	.75 x 36 x 24	60	19	.60	1	\$361
					2	\$387
					3	\$414
					4	\$447
					5	\$486

For StreamLINE Series Hutches Only. **ALL METAL** with tackboard.

Required Specifications

Paint finish
Fabric

S STREAMLINE II™

PEDESTALS

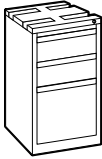

Box/Box/File Pedestal

MODEL#	DIMENSIONS D x W x H	FREIGHT CLASS	WT./LBS.	CUBIC FT.	LIST PRICE
GW PSS18BBF	18 x 15 x 27.62	70	76	4.80	\$462
GW PSS24BBF	24 x 15 x 27.62	85	84	5.80	\$471
GW PSS30BBF	30 x 15 x 27.62	85	94	7.30	\$481

Two box and 1 file drawer pedestal.

- **Cannot be used with 66" w Streamline Extended Corners**

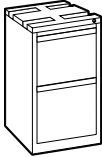

File/File Pedestal

GW PSS18FF	18 x 15 x 27.62	70	76	4.80	\$462
GW PSS24FF	24 x 15 x 27.62	85	84	5.80	\$471
GW PSS30FF	30 x 15 x 27.62	85	97	7.30	\$481

Two file drawer pedestal.

- **Cannot be used with 66" w Streamline Extended Corners**

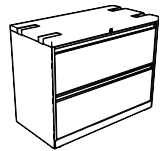

2 Drawer Lateral File - Fixed Front Worksurface supporting

1230P2FFDAO	18 x 30 x 27.75	125	69.29	10	\$713
1236P2FFDAO	18 x 36 x 27.75	125	86	12.38	\$727
1242P2FFDAO	18 x 42 x 27.75	125	105	14.36	\$750

Two fixed front drawers. Side-to-side hanging file bars included.

ACCESSORIES

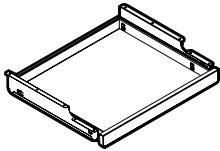

Center Drawer

SDMCD	16.75 x 20 x 1.75	100	8	1	\$128
-------	-------------------	-----	---	---	--------------

Metal drawer front is attached to a 4-sided frame. All Metal.

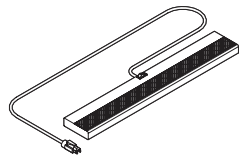

Task Light

PVET5L48	4.25 x 48 x 1.25	65	8	.28	\$175
PVET5L36	4.25 x 36 x 1.25	65	6	.21	\$158
PVET5L24	4.25 x 24 x 1.25	65	4	.15	\$146
PVET5L18	4.25 x 19.5 x 1.25	65	3	.12	\$140

SHTSLB1	--	70	1	.07	\$42
---------	----	----	---	-----	-------------

T5 rapid start fluorescent lamp provides energy-efficient illumination. Slim low profile metal chassis. Electronic ballast. Prismatic acrylic lens included. Attaches to wood or metal units. 9' power cord. Specify 6" shorter than storage unit width.

- When hanging task lights on the underside of steel hutches, the **SHTSLB1** bracket set **MUST BE USED**.

Replacement bulbs for the task light are as follows:

- 24"** - 14W T5 22" soft white
- 36"** - 21W T5 34" soft white
- 48"** - 28W T5 46" neutral

Required Specifications

Top Finish
Body Finish

Optional Specifications

Grommet

benching



Bridges II

338-393



Sidebar

394-445



bridges II connect
share
achieve

Our desire was to develop an environment for collaborative teamwork which would facilitate connection, or bridging of people and ideas. A set of components which would even serve as a catalyst, inviting team members out of their cocooned comfort zones and encouraging them to engage, co-create. With Bridges II you can develop an environment of collaborative teamwork through workspace configuration that enhances line communication and bridges people with a spectrum of ideas and interfaces. Bridges II features a set of components that facilitate communication and streamline interaction through product that efficiently adapts and creatively configures. The product focuses on advancing engagement and collaborative creation through quick adaptations necessary to meet the needs of a fast paced and ever changing work environment. With flexible building components, Bridges II fits numerous applications, from boardrooms to multi-person workstations. It is easy to customize and reconfigure to fit specific requirements.



Features and Benefits

- High Performance Thermally Fused Laminate Tops are 1" thick
- High Pressure Tops are 1 1/16" thick
- Flat matching 3mm edge profile on all sides
- Worksurfaces provided with pilot holes for alignment
- Numerous Power/Data accessories
- Interconnected storage units can form a spine to create space division, storage, cable management and worksurface support
- Leg Options:
Height adjustable Round legs
Fixed height Rectangular legs



Rectangular Leg



Power Trough



Round Leg

GENERAL INFORMATION**Flexible Building components**

- Single leg tables (freestanding or mobile)
- Training Rooms
- Boardrooms
- Libraries
- 1 person general and private office
- 2 person workstation
- 3 person workstation
- 6+ person workstation
- Storage spine-based workstation

Easy to customize and reconfigure to fit specific requirements. From the facility manager's perspective, all workstations can be standardized to form a linear worksurface and power/data services, and their respective function or purpose can be governed by the type, quantity and placement of adjacent components like dividers, storage cabinets, shelves and accessories. These adjacent components can be easily reconfigured with minimal down time - without having to invite electrical and IT crews.

Compatible with various environments

- Clean, simple, elegant design language, with finishes suggesting comfortable, even domestic flavor. Understated to designer combinations, like anodized aluminum and white, give a hint of subtle sophistication.

Choice of **two functionally and visually different leg** supports

- Casters or levelers
- Height adjustable round legs
- Fixed height rectangular legs
- Optional anodized aluminum finish (Rectangular legs only). Refer to individual models for upcharge.

Various **power/data delivery** levels to choose from

- Wire basket to organize cable access under worksurfaces and storage units
- Vertical cable manager integrated into rectangular leg
- Worksurface edge-mounted power/data units (easy to reconfigure, plug into wall/floor outlets), or power troughs
- Single-sided and double-sided below worksurface power/data trough (desktop/floor standing computers and office equipment)
- Worksurface access door (access to below worksurface power outlets and data terminals)
- Above worksurface power/data trough provides immediate access for laptops, tablets and phones
- Storage integrated power/data unit
- Horizontal cable management under storage units with optional wire basket

Interconnected storage units can form a spine to create space division, storage, cable management and worksurface support. Storage leg can be configured to act as a ganging bracket.

- GREENGUARD INDOOR AIR QUALITY CERTIFICATION - Global laminate and seating products are in compliance with stringent emission guidelines set out by the Greenguard Environmental Institute under the standards for low emitting products and materials. www.greenguard.org.

- **Level 2 Certified**

B BRIDGES II™ - NOTES

WORKSURFACES

- Standard in high performance thermally fused laminate. Optional high pressure (HP) laminate available.
- High performance thermally fused laminate tops are 1" thick particle board and have a flat matching 3mm edge profile on all sides
- High pressure (HP) laminate tops are 1 1/16" thick laminate particle board and have a flat matching 3mm edge profile on all sides



- Doors and Drawer Fronts feature a matching 3mm edge. All other surfaces feature a matching self edge.

TABLES

- All multiple linear workstations are standard with levelers
- Tops square for flush surface-to-surface abutment and to accept desk mounted accessories
- Worksurfaces provided with pilot holes for alignment purposes

CODES

- This price list uses a numbering system with meaningful alphanumeric characters to create a simple-to-understand product number. This makes specifying the product much easier and more accurate.

Example of a worksurface:

Product code: BRTWS2472AWC + HP

BRT = Bridges II

WS = Type of Worksurface

2472 = Size: Depth x Width

AWC = High Pressure Laminate

HP = Finish

RECTANGULAR LEG

- For single and shared worksurface support
- Bridges II Rectangular legs are available with:
Locking Casters (**BRTLCS**) or Levelers (**BRTLVS**)

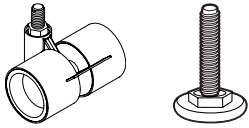

- Casters and Levelers **CANNOT** be retrofitted
- Levelers have a 2" height range, with 5/16" thread
- Levelers are available in Black only
- Casters are 45mm high with 8mm thread, available in White body / Grey tire combination only
- Leg frame is offered in 8 standard paint finishes and anodized aluminum finish
- Paint finish is a durable, environmentally friendly epoxy powder coating
- When anodized finish is selected, crossbeam is always **White**

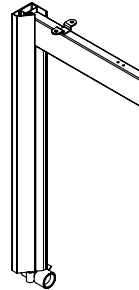

ROUND LEG

- For single and shared worksurface support
- Tubular steel legs are adjustable in 1" increments
- Height adjustment allows the user to easily set the height of a table
- Legs have a height adjustment of 24" - 32" in 1" increments with levelers and 27" - 35" with casters
- Bridges II Round legs are available with:
Locking Casters (**BRTLCR**) or Levelers (**BRTLVR**)

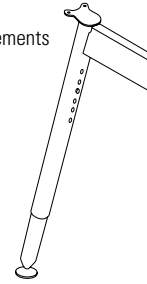
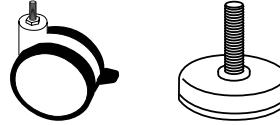

- Casters and Levelers **CAN** be retrofitted
- Levelers have a 1" height range, with 3/8-16" thread
- Levelers are available in Chrome only
- Casters available in Tungsten/Black combination only
- Casters are 3" diameter with an overall height of 3 3/4" with 3/8-16" thread
- Inner legs are available in Chrome only
- Leg frame is offered in 8 standard paint finishes
- Paint finish is a durable, environmentally friendly epoxy powder coating

FINISHES

Metal Frame Finishes:

BLK	Black
CHR	Charcoal
DWT	Designer White
NEV	Nevada
SIL	Silver
TPE	Taupe
TUN	Tungsten
TU2	Tungsten 2
ANO	Anodized Aluminum - Upcharge applies. Refer to models for upcharge.

Laminate Top Finishes:

ACJ	Absolute Acajou
ASN	Asian Night
AWC	Avant Cherry
AWH	Avant Honey
BLK	Black - Coordinates with BLK Metal Frame Finish
BRC	Brushed Cobalt
CSJ	Constellation Java
CGY	Custom Grey - Coordinates with SIL Metal Frame Finish
DES	Dark Espresso
DWT	Designer White - Coordinates with DWT Metal Frame Finish
HGT	Hayden Grey
RCL	River Cherry
SKC	Shaker Cherry
SSL	Satin Stainless - Coordinates with TUN Metal Frame Finish
SOG	Storm Grey - Coordinates with CHR Metal Frame Finish
STG	String - Coordinates with NEV Metal Frame Finish
TFW	Tiger Fruitwood
TMP	Tiger Maple
TWL	Tiger Walnut
WHC	White Chocolate
WGY	Willow Grey

Chassis/Accent Finishes:

ACJ	Absolute Acajou
ASN	Asian Night
AWC	Avant Cherry
AWH	Avant Honey
BLK	Black - Coordinates with BLK Metal Frame Finish
CGY	Custom Grey - Coordinates with SIL Metal Frame Finish
DWT	Designer White - Coordinates with DWT Metal Frame Finish
RCL	River Cherry
SKC	Shaker Cherry
SSL	Satin Stainless - Coordinates with TUN Metal Frame Finish
SOG	Storm Grey - Coordinates with CHR Metal Frame Finish
STG	String - Coordinates with NEV Metal Frame Finish
HGT	Hayden Grey - Coordinates with TPE Metal Frame Finish
TWL	Tiger Walnut
WHC	White Chocolate

FABRIC TABLE DIVIDERS

Bridges II Fabric Table Dividers are available in:

- Global: **Lola, Brinx, Mariposa, Accent** and **Coordinate**
- Momentum: **Meander, Tracery** and **Universe (extended lead time)**.

30"W UNITS STORAGE CAPACITY CHART

Side to Side

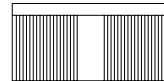

LETTER LETTER

Side to Side Letter/Front to Back Legal

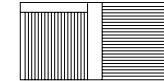

LETTER LEGAL

36"W UNITS STORAGE CAPACITY CHART

Side to Side Letter

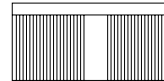

LETTER LETTER

Side to Side Legal

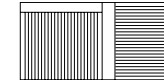

LETTER LEGAL

Side to Side Letter/Front to Back Legal



LEGAL LEGAL

RECTANGULAR LEG PACKAGES

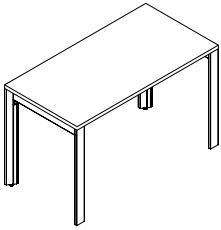

Single Line 1 Person Pod with Levelers

MODEL#	DIMENSIONS	FREIGHT CLASS	WT./LBS.	CUBIC FT.	LIST PRICE	HP ADD
D x W x H						
BRTS1P2484L	24 x 84 x 29	70	75	4.92	\$1260	\$121
BRTS1P2478L	24 x 78 x 29	85	72	4.82	\$1223	\$115
BRTS1P2472L	24 x 72 x 29	85	69	4.73	\$1181	\$120
BRTS1P2466L	24 x 66 x 29	85	66	4.65	\$1167	\$106
BRTS1P2463L	24 x 62.5 x 29	85	63	4.57	\$1158	\$103
BRTS1P2460L	24 x 60 x 29	85	60	4.48	\$1146	\$102
BRTS1P2454L	24 x 54 x 29	85	57	4.40	\$1106	\$88
BRTS1P2451L	24 x 50.5 x 29	85	54	4.30	\$1076	\$84
BRTS1P2448L	24 x 48 x 29	85	51	4.20	\$1047	\$79
BRTS1P2442L	24 x 42 x 29	92.5	48	4.10	\$1001	\$65
BRTS1P2436L	24 x 36 x 29	92.5	45	4	\$940	\$56
BRTS1P3084L	30 x 84 x 29	70	84	5.20	\$1322	\$130
BRTS1P3078L	30 x 78 x 29	70	81	5.10	\$1270	\$120
BRTS1P3072L	30 x 72 x 29	70	78	5.01	\$1240	\$117
BRTS1P3066L	30 x 66 x 29	70	75	4.90	\$1211	\$112
BRTS1P3063L	30 x 62.5 x 29	70	72	4.80	\$1201	\$109
BRTS1P3060L	30 x 60 x 29	85	69	4.73	\$1190	\$106
BRTS1P3054L	30 x 54 x 29	85	66	4.60	\$1162	\$87
BRTS1P3051L	30 x 50.5 x 29	85	63	4.50	\$1141	\$92
BRTS1P3048L	30 x 48 x 29	85	60	4.41	\$1121	\$88
BRTS1P3042L	30 x 42 x 29	85	57	4.30	\$1097	\$86
BRTS1P3036L	30 x 36 x 29	85	54	4.20	\$1013	\$60

Single Line Table Assemblies consist of one worksurface, two leg assemblies, and one supporting structural beam.

- Anodized Aluminum Leg - Add **\$109** list upcharge

Required Specifications

Finish (top)
Metal Finish (legs)

Optional Specifications

Anodized Aluminum Leg
High Pressure Laminate

RECTANGULAR LEG PACKAGES

MODEL#	DIMENSIONS	FREIGHT CLASS	WT/LBS.	CUBIC FT.	LIST PRICE	HP ADD
	D x W x H					
BRTS1P2484C	24 x 84 x 29	70	75	4.92	\$1322	\$121
BRTS1P2478C	24 x 78 x 29	85	72	4.82	\$1285	\$115
BRTS1P2472C	24 x 72 x 29	85	69	4.73	\$1251	\$112
BRTS1P2466C	24 x 66 x 29	85	66	4.65	\$1229	\$106
BRTS1P2463C	24 x 62.5 x 29	85	63	4.57	\$1220	\$103
BRTS1P2460C	24 x 60 x 29	85	60	4.48	\$1208	\$102
BRTS1P2454C	24 x 54 x 29	85	57	4.40	\$1167	\$88
BRTS1P2451C	24 x 50.5 x 29	85	54	4.30	\$1138	\$84
BRTS1P2448C	24 x 48 x 29	85	51	4.20	\$1109	\$79
BRTS1P2442C	24 x 42 x 29	92.5	48	4.10	\$1062	\$65
BRTS1P2436C	24 x 36 x 29	92.5	45	4	\$1002	\$56
BRTS1P3084C	30 x 84 x 29	70	84	5.20	\$1394	\$120
BRTS1P3078C	30 x 78 x 29	70	81	5.10	\$1332	\$120
BRTS1P3072C	30 x 72 x 29	70	78	5.01	\$1301	\$101
BRTS1P3066C	30 x 66 x 29	70	75	4.90	\$1273	\$112
BRTS1P3063C	30 x 62.5 x 29	70	72	4.80	\$1263	\$109
BRTS1P3060C	30 x 60 x 29	85	69	4.73	\$1252	\$106
BRTS1P3054C	30 x 54 x 29	85	66	4.60	\$1224	\$87
BRTS1P3051C	30 x 50.5 x 29	85	63	4.50	\$1203	\$92
BRTS1P3048C	30 x 48 x 29	85	60	4.41	\$1183	\$88
BRTS1P3042C	30 x 42 x 29	85	57	4.30	\$1159	\$86
BRTS1P3036C	30 x 36 x 29	85	54	4.20	\$1075	\$60

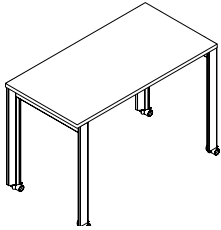

Single Line 1 Person Pod with Casters

Single Line Table Assemblies consist of one worksurface, two leg assemblies, and one supporting structural beam. 40mm white locking casters with grey tires; steel horizontal beams, aluminum legs.

- Anodized Aluminum Leg - Add **\$109**. list upcharge

Required Specifications

Finish (top)
Metal Finish (legs)

Optional Specifications

Anodized Aluminum Leg
High Pressure Laminate

RECTANGULAR LEG PACKAGES

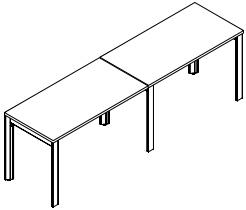

Single Line 2 Person Pod with Levelers

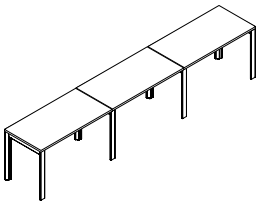

Single Line 3 Person Pod with Levelers

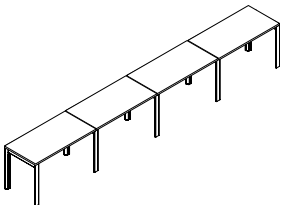

Single Line 4 Person Pod with Levelers

MODEL#	DIMENSIONS D x W x H	FREIGHT CLASS	WT/LBS.	CUBIC FT.	LIST PRICE	HP ADD
BRTS2P2484L	24 x 168 x 29	70	149	7.41	\$2210	\$242
BRTS2P2478L	24 x 156 x 29	70	140	7.27	\$2136	\$229
BRTS2P2472L	24 x 144 x 29	70	131	7.13	\$2068	\$223
BRTS2P2466L	24 x 132 x 29	70	122	6.95	\$2024	\$211
BRTS2P2460L	24 x 120 x 29	70	113	6.71	\$1981	\$204
BRTS2P2454L	24 x 108 x 29	70	104	6.45	\$1901	\$177
BRTS2P2448L	24 x 96 x 29	70	95	6.21	\$1783	\$158
BRTS2P3084L	30 x 168 x 29	70	173	8.25	\$2318	\$260
BRTS2P3078L	30 x 156 x 29	70	164	7.97	\$2216	\$238
BRTS2P3072L	30 x 144 x 29	70	155	7.69	\$2170	\$232
BRTS2P3066L	30 x 132 x 29	70	140	7.41	\$2096	\$223
BRTS2P3060L	30 x 120 x 29	70	131	7.13	\$2055	\$211
BRTS2P3054L	30 x 108 x 29	70	122	6.85	\$1997	\$177
BRTS2P3048L	30 x 96 x 29	70	113	6.57	\$1916	\$177

Single Line 2 Person workstation consists of two worksurfaces, three leg assemblies, and two supporting structural beams. One leg can be shared by 2 adjoining worksurfaces.

- Anodized Aluminum Leg - Add **\$162.** list upcharge

BRTS3P2484L	24 x 252 x 29	70	219	9.74	\$3161	\$362
BRTS3P2478L	24 x 234 x 29	70	206	9.53	\$3049	\$343
BRTS3P2472L	24 x 216 x 29	70	192	9.32	\$2947	\$334
BRTS3P2466L	24 x 198 x 29	70	179	9.11	\$2882	\$316
BRTS3P2460L	24 x 180 x 29	70	165	8.89	\$2818	\$292
BRTS3P2454L	24 x 162 x 29	70	152	8.68	\$2697	\$264
BRTS3P2448L	24 x 144 x 29	70	138	8.47	\$2521	\$236

BRTS3P3084L	30 x 252 x 29	65	263	11.59	\$3315	\$390
BRTS3P3078L	30 x 234 x 29	70	246	11.16	\$3162	\$358
BRTS3P3072L	30 x 216 x 29	70	229	10.72	\$3069	\$349
BRTS3P3066L	30 x 198 x 29	70	212	10.30	\$2981	\$334
BRTS3P3060L	30 x 180 x 29	70	195	9.87	\$2921	\$316
BRTS3P3054L	30 x 162 x 29	70	178	9.44	\$2833	\$264
BRTS3P3048L	30 x 144 x 29	70	161	9.01	\$2712	\$264

Single Line 3 Person workstation consists of three worksurfaces, four leg assemblies, and three supporting structural beams. One leg can be shared by 2 adjoining worksurfaces.

- Anodized Aluminum Leg - Add **\$217.** list upcharge

BRTS4P2484L	24 x 336 x 29	70	291	13.67	\$4110	\$483
BRTS4P2478L	24 x 312 x 29	70	273	13.18	\$3962	\$458
BRTS4P2472L	24 x 288 x 29	70	254	12.69	\$3850	\$452
BRTS4P2466L	24 x 264 x 29	70	236	12.20	\$3739	\$421
BRTS4P2460L	24 x 240 x 29	70	217	11.71	\$3653	\$408
BRTS4P2454L	24 x 216 x 29	70	199	11.22	\$3492	\$353
BRTS4P2448L	24 x 192 x 29	70	180	10.73	\$3257	\$316

BRTS4P3084L	30 x 336 x 29	65	345	14.87	\$4311	\$520
BRTS4P3078L	30 x 312 x 29	65	323	14.30	\$4107	\$476
BRTS4P3072L	30 x 288 x 29	70	301	13.73	\$3984	\$464
BRTS4P3066L	30 x 264 x 29	70	279	13.16	\$3866	\$445
BRTS4P3060L	30 x 240 x 29	70	257	12.59	\$3786	\$421
BRTS4P3054L	30 x 216 x 29	70	235	12.02	\$3668	\$353
BRTS4P3048L	30 x 192 x 29	70	213	11.45	\$3508	\$353

Single Line 4 Person workstation consists of four worksurfaces, five leg assemblies, and four supporting structural beams. One leg can be shared by 2 adjoining worksurfaces.

- Anodized Aluminum Leg - Add **\$272.** list upcharge

Required Specifications

Finish (top)
Metal Finish (legs)

Optional Specifications

Anodized Aluminum Leg
High Pressure Laminate

RECTANGULAR LEG PACKAGES

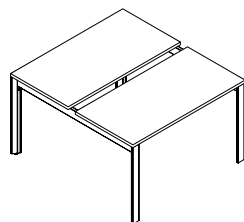

Back-to-Back 2 Person Pod with Levelers

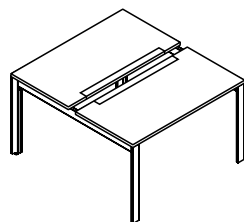

Back-to-Back 2 Person Pod with Access Door and Levelers

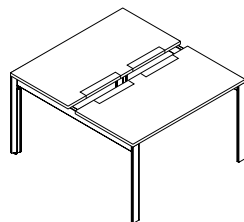

Back-to-Back 2 Person Pod with Access Doors and Levelers

MODEL#	DIMENSIONS D x W x H	FREIGHT CLASS	WT/LBS.	CUBIC FT.	LIST PRICE	HP ADD
BRTBAR2P2484L	50.5 x 84 x 29	70	146	9.40	\$2086	\$242
BRTBAR2P2478L	50.5 x 78 x 29	85	137	9.20	\$2012	\$229
BRTBAR2P2472L	50.5 x 72 x 29	85	128	9.02	\$1944	\$223
BRTBAR2P2466L	50.5 x 66 x 29	85	119	8.76	\$1901	\$211
BRTBAR2P2460L	50.5 x 60 x 29	85	110	8.56	\$1858	\$204
BRTBAR2P3084L	62.5 x 84 x 29	70	174	10.40	\$2148	\$260
BRTBAR2P3078L	62.5 x 78 x 29	70	163	9.80	\$2054	\$230
BRTBAR2P3072L	62.5 x 72 x 29	70	152	9.54	\$1987	\$229
BRTBAR2P3066L	62.5 x 66 x 29	70	141	9.25	\$1926	\$223
BRTBAR2P3060L	62.5 x 60 x 29	85	130	9	\$1885	\$211

Back-to-back 2 Person workstation consists of two worksurfaces, two back-to-back leg assemblies, and two supporting structural beams.

- Anodized Aluminum Leg - Add **\$109**. list upcharge

BRTBAR2PA2484L	50.5 x 84 x 29	70	146	9.40	\$2194	\$433
BRTBAR2PA2478L	50.5 x 78 x 29	85	137	9.20	\$2133	\$387
BRTBAR2PA2472L	50.5 x 72 x 29	85	128	9.02	\$2086	\$371
BRTBAR2PA2466L	50.5 x 66 x 29	85	119	8.76	\$2009	\$325
BRTBAR2PA2460L	50.5 x 60 x 29	85	110	8.56	\$1932	\$294
BRTBAR2PA3084L	62.5 x 84 x 29	70	174	10.40	\$2395	\$526
BRTBAR2PA3078L	62.5 x 78 x 29	70	163	9.80	\$2318	\$495
BRTBAR2PA3072L	62.5 x 72 x 29	70	152	9.54	\$2272	\$449
BRTBAR2PA3066L	62.5 x 66 x 29	70	141	9.25	\$2194	\$402
BRTBAR2PA3060L	62.5 x 60 x 29	85	130	9	\$2086	\$371

Back-to-back 2 Person workstation consists of two worksurfaces, two back-to-back leg assemblies, and two supporting structural beams. Anodized aluminum worksurface door provides access to power/data trough below worksurface. Worksurface with access doors CANNOT be combined with above worksurface power trough.

- Anodized Aluminum Leg - Add **\$109**. list upcharge

BRTBAR2PDA2484L	50.5 x 84 x 29	70	146	9.40	\$2368	\$464
BRTBAR2PDA2478L	50.5 x 78 x 29	85	137	9.20	\$2301	\$416
BRTBAR2PDA2472L	50.5 x 72 x 29	85	128	9.02	\$2252	\$399
BRTBAR2PDA2466L	50.5 x 66 x 29	85	119	8.76	\$2168	\$350
BRTBAR2PDA2460L	50.5 x 60 x 29	85	110	8.56	\$2085	\$315
BRTBAR2PDA3084L	62.5 x 84 x 29	70	174	10.40	\$2585	\$565
BRTBAR2PDA3078L	62.5 x 78 x 29	70	163	9.80	\$2501	\$531
BRTBAR2PDA3072L	62.5 x 72 x 29	70	152	9.54	\$2452	\$481
BRTBAR2PDA3066L	62.5 x 66 x 29	70	141	9.25	\$2368	\$430
BRTBAR2PDA3060L	62.5 x 60 x 29	85	130	9	\$2252	\$399

Back-to-back 2 Person workstation consists of two worksurfaces, two back-to-back leg assemblies, and two supporting structural beams. These tables feature dual access doors providing a central connection point for monitor lifts. Anodized aluminum worksurface door provides access to power/data trough below worksurface. Worksurface with access doors CANNOT be combined with above worksurface power trough.

- Anodized Aluminum Leg - Add **\$109**. list upcharge

Required Specifications

Finish (top)
Metal Finish (legs)

Optional Specifications

Anodized Aluminum Leg
High Pressure Laminate

RECTANGULAR LEG PACKAGES

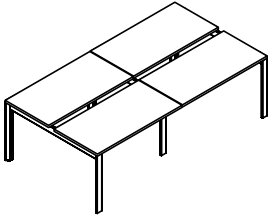

Back-to-Back 4 Person Pod with Levelers

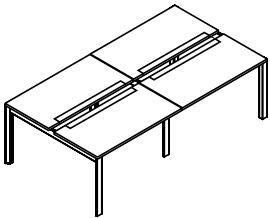

Back-to-Back 4 Person Pod with Access Door and Levelers

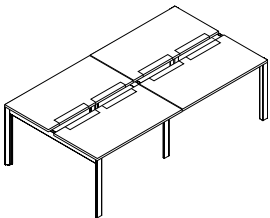

Back-to-Back 4 Person Pod with Access Door and Levelers

MODEL#	DIMENSIONS D x W x H	FREIGHT CLASS	WT/LBS.	CUBIC FT.	LIST PRICE	HP ADD
BRTBAR4P2484L	50.5 x 168 x 29	70	272	15.66	\$3739	\$483
BRTBAR4P2478L	50.5 x 156 x 29	70	256	15.20	\$3591	\$458
BRTBAR4P2472L	50.5 x 144 x 29	70	240	14.74	\$3455	\$445
BRTBAR4P2466L	50.5 x 132 x 29	70	224	14.28	\$3369	\$421
BRTBAR4P2460L	50.5 x 120 x 29	70	208	13.82	\$3282	\$408
BRTBAR4P3084L	62.5 x 168 x 29	70	333	16.86	\$3894	\$520
BRTBAR4P3078L	62.5 x 156 x 29	70	313	16.32	\$3690	\$476
BRTBAR4P3072L	62.5 x 144 x 29	70	293	15.78	\$3566	\$464
BRTBAR4P3066L	62.5 x 132 x 29	70	273	15.24	\$3449	\$445
BRTBAR4P3060L	62.5 x 120 x 29	70	253	14.70	\$3369	\$421

Back-to-back 4 Person workstation consists of four worksurfaces, two back-to-back outer leg assemblies, 1 back-to-back narrow leg assembly, and four supporting structural beams.

- Anodized Aluminum Leg - Add **\$162.** list upcharge

BRTBAR4PA2484L	50.5 x 168 x 29	70	272	15.66	\$3956	\$866
BRTBAR4PA2478L	50.5 x 156 x 29	70	256	15.20	\$3832	\$773
BRTBAR4PA2472L	50.5 x 144 x 29	70	240	14.74	\$3739	\$742
BRTBAR4PA2466L	50.5 x 132 x 29	70	224	14.28	\$3585	\$649
BRTBAR4PA2460L	50.5 x 120 x 29	70	208	13.82	\$3430	\$588
BRTBAR4PA3084L	62.5 x 168 x 29	70	333	16.86	\$4326	\$1051
BRTBAR4PA3078L	62.5 x 156 x 29	70	313	16.32	\$4172	\$989
BRTBAR4PA3072L	62.5 x 144 x 29	70	293	15.78	\$4079	\$897
BRTBAR4PA3066L	62.5 x 132 x 29	70	273	15.24	\$3925	\$804
BRTBAR4PA3060L	62.5 x 120 x 29	70	253	14.70	\$3708	\$742

Back-to-back 4 Person workstation consists of four worksurfaces, two back-to-back outer leg assemblies, 1 back-to-back narrow leg assembly, and four supporting structural beams. Anodized aluminum worksurface door provides access to power/data trough below worksurface. Worksurface with access doors CANNOT be combined with above worksurface power trough.

- Anodized Aluminum Leg - Add **\$162.** list upcharge

BRTBAR4PDA2484L	50.5 x 168 x 29	70	272	15.66	\$4268	\$929
BRTBAR4PDA2478L	50.5 x 156 x 29	70	256	15.20	\$4135	\$830
BRTBAR4PDA2472L	50.5 x 144 x 29	70	240	14.74	\$4034	\$798
BRTBAR4PDA2466L	50.5 x 132 x 29	70	224	14.28	\$3869	\$695
BRTBAR4PDA2460L	50.5 x 120 x 29	70	208	13.82	\$3701	\$630
BRTBAR4PDA3084L	62.5 x 168 x 29	70	333	16.86	\$4668	\$1128
BRTBAR4PDA3078L	62.5 x 156 x 29	70	313	16.32	\$4501	\$1063
BRTBAR4PDA3072L	62.5 x 144 x 29	70	293	15.78	\$4402	\$962
BRTBAR4PDA3066L	62.5 x 132 x 29	70	273	15.24	\$4234	\$864
BRTBAR4PDA3060L	62.5 x 120 x 29	70	253	14.70	\$4002	\$796

Back-to-back 4 Person workstation consists of four worksurfaces, two back-to-back outer leg assemblies, 1 back-to-back narrow leg assembly, and four supporting structural beams. These tables feature dual access doors providing a central connection point for monitor lifts. Anodized aluminum worksurface door provides access to power/data trough below worksurface. Worksurface with access doors CANNOT be combined with above worksurface power trough.

- Anodized Aluminum Leg - Add **\$162.** list upcharge

Required Specifications

Finish (top)
Metal Finish (legs)

Optional Specifications

Anodized Aluminum Leg
High Pressure Laminate

RECTANGULAR LEG PACKAGES

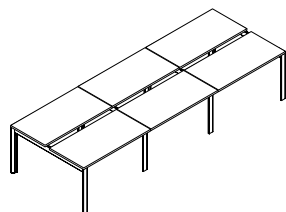

Back-to-Back 6 Person Pod with Levelers

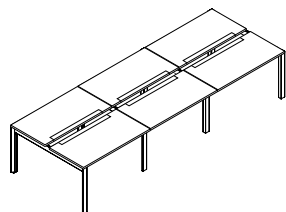

Back-to-Back 6 Person Pod with Access Door and Levelers

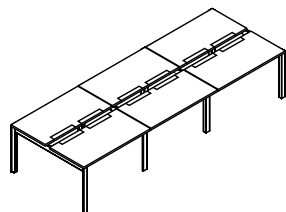

Back-to-Back 6 Person Pod with Access Door and Levelers

MODEL#	DIMENSIONS D x W x H	FREIGHT CLASS	WT/LBS.	CUBIC FT.	LIST PRICE	HP ADD
BRTBAR6P2484L	50.5 x 252 x 29	70	434	22.88	\$5393	\$724
BRTBAR6P2478L	50.5 x 234 x 29	70	409	22.10	\$5170	\$686
BRTBAR6P2472L	50.5 x 216 x 29	70	359	21.32	\$4966	\$668
BRTBAR6P2466L	50.5 x 198 x 29	70	329	20.54	\$4836	\$631
BRTBAR6P2460L	50.5 x 180 x 29	70	308	19.76	\$4676	\$612
BRTBAR6P3084L	62.5 x 252 x 29	70	493	24.53	\$5609	\$779
BRTBAR6P3078L	62.5 x 234 x 29	70	462	23.75	\$5303	\$714
BRTBAR6P3072L	62.5 x 216 x 29	70	431	22.86	\$5118	\$696
BRTBAR6P3066L	62.5 x 198 x 29	70	400	21.97	\$4941	\$668
BRTBAR6P3060L	62.5 x 180 x 29	70	369	21.08	\$4790	\$631

Back-to-back 6 Person workstation consists of six worksurfaces, two back-to-back outer leg assemblies, two back-to-back narrow leg assemblies, and six supporting structural beams.

- Anodized Aluminum Leg - Add **\$217**. list upcharge

BRTBAR6PA2484L	50.5 x 252 x 29	70	434	22.88	\$5717	\$1298
BRTBAR6PA2478L	50.5 x 234 x 29	70	409	22.10	\$5532	\$1159
BRTBAR6PA2472L	50.5 x 216 x 29	70	359	21.32	\$5393	\$1113
BRTBAR6PA2466L	50.5 x 198 x 29	70	329	20.54	\$5161	\$974
BRTBAR6PA2460L	50.5 x 180 x 29	70	308	19.76	\$4898	\$881
BRTBAR6PA3084L	62.5 x 252 x 29	70	493	24.53	\$6258	\$1576
BRTBAR6PA3078L	62.5 x 234 x 29	70	462	23.75	\$6026	\$1484
BRTBAR6PA3072L	62.5 x 216 x 29	70	431	22.86	\$5887	\$1345
BRTBAR6PA3066L	62.5 x 198 x 29	70	400	21.97	\$5655	\$1206
BRTBAR6PA3060L	62.5 x 180 x 29	70	369	21.08	\$5300	\$1113

Back-to-back 6 Person workstation consists of six worksurfaces, two back-to-back outer leg assemblies, two back-to-back narrow leg assemblies, and six supporting structural beams. Anodized aluminum worksurface door provides access to power/data trough below worksurface. Worksurface with access doors CANNOT be combined with above worksurface power trough.

- Anodized Aluminum Leg - Add **\$217**. list upcharge

BRTBAR6PDA2484L	50.5 x 252 x 29	70	434	22.88	\$6169	\$1392
BRTBAR6PDA2478L	50.5 x 234 x 29	70	409	22.10	\$5969	\$1246
BRTBAR6PDA2472L	50.5 x 216 x 29	70	359	21.32	\$5819	\$1196
BRTBAR6PDA2466L	50.5 x 198 x 29	70	329	20.54	\$5568	\$1000
BRTBAR6PDA2460L	50.5 x 180 x 29	70	308	19.76	\$5285	\$946
BRTBAR6PDA3084L	62.5 x 252 x 29	70	493	24.53	\$6753	\$1694
BRTBAR6PDA3078L	62.5 x 234 x 29	70	462	23.75	\$6502	\$1593
BRTBAR6PDA3072L	62.5 x 216 x 29	70	431	22.86	\$6352	\$1443
BRTBAR6PDA3066L	62.5 x 198 x 29	70	400	21.97	\$6102	\$1294
BRTBAR6PDA3060L	62.5 x 180 x 29	70	369	21.08	\$5719	\$1195

Back-to-back 6 Person workstation consists of six worksurfaces, two back-to-back outer leg assemblies, two back-to-back narrow leg assemblies, and six supporting structural beams. These tables feature dual access doors providing a central connection point for monitor lifts. Anodized aluminum worksurface door provides access to power/data trough below worksurface. Worksurface with access doors CANNOT be combined with above worksurface power trough.

- Anodized Aluminum Leg - Add **\$217**. list upcharge

Required Specifications

Finish (top)
Metal Finish (legs)

Optional Specifications

Anodized Aluminum Leg
High Pressure Laminate

RECTANGULAR LEG PACKAGES

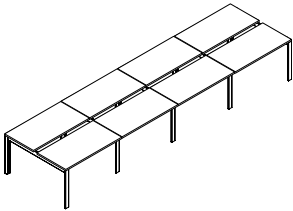

Back-to-Back 8 Person Pod with Levelers

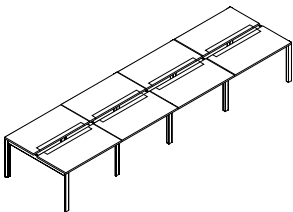

Back-to-Back 8 Person Pod with Access Door and Levelers

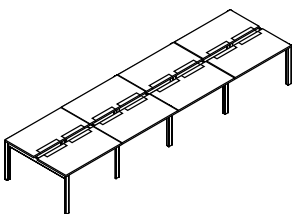

Back-to-Back 8 Person Pod with Access Door and Levelers

MODEL#	DIMENSIONS D x W x H	FREIGHT CLASS	WT./LBS.	CUBIC FT.	LIST PRICE	HP ADD
BRTBAR8P2484L	50.5 x 336 x 29	70	556	28.30	\$7046	\$965
BRTBAR8P2478L	50.5 x 312 x 29	70	520	27.30	\$6749	\$915
BRTBAR8P2472L	50.5 x 288 x 29	70	484	26.30	\$6477	\$890
BRTBAR8P2466L	50.5 x 264 x 29	70	448	25.30	\$6304	\$841
BRTBAR8P2460L	50.5 x 240 x 29	70	412	24.42	\$6162	\$816
BRTBAR8P3084L	62.5 x 336 x 29	70	669	30.58	\$7324	\$1039
BRTBAR8P3078L	62.5 x 312 x 29	70	625	29.48	\$6916	\$952
BRTBAR8P3072L	62.5 x 288 x 29	70	581	28.38	\$6669	\$927
BRTBAR8P3066L	62.5 x 264 x 29	70	536	27.28	\$6434	\$890
BRTBAR8P3060L	62.5 x 240 x 29	70	492	26.18	\$6273	\$841

Back-to-back 8 Person workstation consists of eight worksurfaces, two back-to-back outer leg assemblies, three back-to-back narrow leg assemblies, and eight supporting structural beams.

- Anodized Aluminum Leg - Add **\$272.** list upcharge

BRTBAR8PA2484L	50.5 x 336 x 29	70	556	28.30	\$7478	\$1731
BRTBAR8PA2478L	50.5 x 312 x 29	70	520	27.30	\$7231	\$1545
BRTBAR8PA2472L	50.5 x 288 x 29	70	484	26.30	\$7046	\$1484
BRTBAR8PA2466L	50.5 x 264 x 29	70	448	25.30	\$6737	\$1298
BRTBAR8PA2460L	50.5 x 240 x 29	70	412	24.42	\$6459	\$1175
BRTBAR8PA3084L	62.5 x 336 x 29	70	669	30.58	\$8189	\$2102
BRTBAR8PA3078L	62.5 x 312 x 29	70	625	29.48	\$7880	\$1978
BRTBAR8PA3072L	62.5 x 288 x 29	70	581	28.38	\$7695	\$1793
BRTBAR8PA3066L	62.5 x 264 x 29	70	536	27.28	\$7386	\$1607
BRTBAR8PA3060L	62.5 x 240 x 29	70	492	26.18	\$6953	\$1484

Back-to-back 8 Person workstation consists of eight worksurfaces, two back-to-back outer leg assemblies, three back-to-back narrow leg assemblies, and eight supporting structural beams. Anodized aluminum worksurface door provides access to power/data trough below worksurface. Worksurface with access doors CANNOT be combined with above worksurface power trough.

- Anodized Aluminum Leg - Add **\$272.** list upcharge

BRTBAR8PDA2484L	50.5 x 336 x 29	70	556	28.30	\$8069	\$1859
BRTBAR8PDA2478L	50.5 x 312 x 29	70	520	27.30	\$7801	\$1661
BRTBAR8PDA2472L	50.5 x 288 x 29	70	484	26.30	\$7602	\$1594
BRTBAR8PDA2466L	50.5 x 264 x 29	70	448	25.30	\$7268	\$1395
BRTBAR8PDA2460L	50.5 x 240 x 29	70	412	24.42	\$6968	\$1262
BRTBAR8PDA3084L	62.5 x 336 x 29	70	669	30.58	\$8836	\$2098
BRTBAR8PDA3078L	62.5 x 312 x 29	70	625	29.48	\$8501	\$2126
BRTBAR8PDA3072L	62.5 x 288 x 29	70	581	28.38	\$8301	\$1927
BRTBAR8PDA3066L	62.5 x 264 x 29	70	536	27.28	\$7969	\$1725
BRTBAR8PDA3060L	62.5 x 240 x 29	70	492	26.18	\$7502	\$1594

Back-to-back 8 Person workstation consists of eight worksurfaces, two back-to-back outer leg assemblies, three back-to-back narrow leg assemblies, and eight supporting structural beams. These tables feature dual access doors providing a central connection point for monitor lifts. Anodized aluminum worksurface door provides access to power/data trough below worksurface. Worksurface with access doors CANNOT be combined with above worksurface power trough.

- Anodized Aluminum Leg - Add **\$272.** list upcharge

Required Specifications

Finish (top)
Metal Finish (legs)

Optional Specifications

Anodized Aluminum Leg
High Pressure Laminate

ROUND LEG PACKAGES

MODEL#	DIMENSIONS	FREIGHT CLASS	WT./LBS.	CUBIC FT.	LIST PRICE	HP ADD
--------	------------	---------------	----------	-----------	------------	--------

D x W x H

BRTS1P2484LR	24 x 84 x 29	70	75	4.92	\$1297	\$121
BRTS1P2478LR	24 x 78 x 29	85	72	4.82	\$1260	\$115
BRTS1P2472LR	24 x 72 x 29	85	69	4.73	\$1226	\$112
BRTS1P2466LR	24 x 66 x 29	85	66	4.65	\$1205	\$106
BRTS1P2463LR	24 x 62.5 x 29	85	63	4.57	\$1195	\$103
BRTS1P2460LR	24 x 60 x 29	85	60	4.48	\$1183	\$102
BRTS1P2454LR	24 x 54 x 29	85	57	4.40	\$1158	\$73
BRTS1P2451LR	24 x 50.5 x 29	85	54	4.30	\$1113	\$68
BRTS1P2448LR	24 x 48 x 29	85	51	4.20	\$1084	\$79
BRTS1P2442LR	24 x 42 x 29	92.5	48	4.10	\$1038	\$50
BRTS1P2436LR	24 x 36 x 29	92.5	45	4	\$1004	\$34

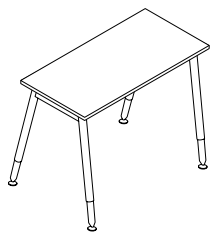

Single Line 1 Person Pod with Levelers
Round Leg

BRTS1P3084LR	30 x 84 x 29	70	75	4.92	\$1328	\$130
BRTS1P3078LR	30 x 78 x 29	85	72	4.82	\$1277	\$120
BRTS1P3072LR	30 x 72 x 29	85	69	4.73	\$1246	\$101
BRTS1P3066LR	30 x 66 x 29	85	66	4.65	\$1217	\$112
BRTS1P3063LR	30 x 62.5 x 29	85	63	4.57	\$1208	\$109
BRTS1P3060LR	30 x 60 x 29	85	60	4.48	\$1196	\$90
BRTS1P3054LR	30 x 54 x 29	85	57	4.40	\$1167	\$88
BRTS1P3051LR	30 x 50.5 x 29	85	54	4.30	\$1147	\$92
BRTS1P3048LR	30 x 48 x 29	85	51	4.20	\$1112	\$88
BRTS1P3042LR	30 x 42 x 29	92.5	48	4.10	\$1088	\$86
BRTS1P3036LR	30 x 36 x 29	92.5	45	4	\$974	\$61

Single Line Table Assemblies consist of one worksurface, two leg assemblies, and one supporting structural beam.

BRTS1P2484CR	24 x 84 x 29	70	75	4.92	\$1371	\$121
BRTS1P2478CR	24 x 78 x 29	85	72	4.82	\$1334	\$115
BRTS1P2472CR	24 x 72 x 29	85	69	4.73	\$1300	\$112
BRTS1P2466CR	24 x 66 x 29	85	66	4.65	\$1279	\$106
BRTS1P2463CR	24 x 62.5 x 29	85	63	4.57	\$1269	\$103
BRTS1P2460CR	24 x 60 x 29	85	60	4.48	\$1257	\$102
BRTS1P2454CR	24 x 54 x 29	85	57	4.40	\$1232	\$73
BRTS1P2451CR	24 x 50.5 x 29	85	54	4.30	\$1187	\$68
BRTS1P2448CR	24 x 48 x 29	85	51	4.20	\$1158	\$79
BRTS1P2442CR	24 x 42 x 29	92.5	48	4.10	\$1112	\$50
BRTS1P2436CR	24 x 36 x 29	92.5	45	4	\$1078	\$34

BRTS1P3084CR	30 x 84 x 29	70	75	4.92	\$1402	\$130
BRTS1P3078CR	30 x 78 x 29	85	72	4.82	\$1351	\$120
BRTS1P3072CR	30 x 72 x 29	85	69	4.73	\$1323	\$98
BRTS1P3066CR	30 x 66 x 29	85	66	4.65	\$1291	\$112
BRTS1P3063CR	30 x 62.5 x 29	85	63	4.57	\$1282	\$109
BRTS1P3060CR	30 x 60 x 29	85	60	4.48	\$1270	\$90
BRTS1P3054CR	30 x 54 x 29	85	57	4.40	\$1242	\$88
BRTS1P3051CR	30 x 50.5 x 29	85	54	4.30	\$1221	\$92
BRTS1P3048CR	30 x 48 x 29	85	51	4.20	\$1186	\$88
BRTS1P3042CR	30 x 42 x 29	92.5	48	4.10	\$1162	\$86
BRTS1P3036CR	30 x 36 x 29	92.5	45	4	\$1048	\$61

Single Line Table Assemblies consist of one worksurface, two leg assemblies, and one supporting structural beam. 40mm locking casters with grey tires; steel horizontal beams, aluminum legs.

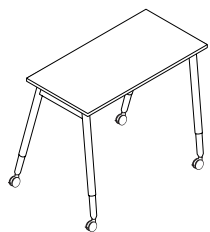

Single Line 1 Person Pod with Casters
Round Leg

Required Specifications

Finish (top)
Metal Finish (legs)

Optional Specifications

High Pressure Laminate

ROUND LEG PACKAGES

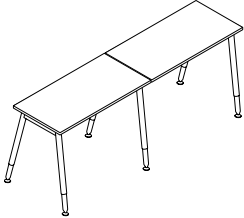

Single Line 2 Person Pod with Levelers Round Leg

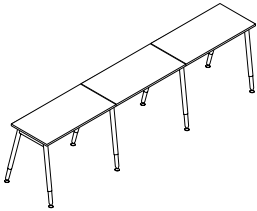

Single Line 3 Person Pod with Levelers Round Leg

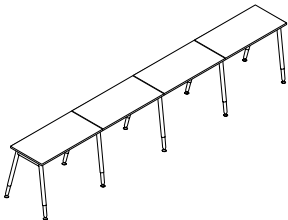

Single Line 4 Person Pod with Levelers Round Leg

MODEL#	DIMENSIONS D x W x H	FREIGHT CLASS	WT/LBS.	CUBIC FT.	LIST PRICE	HP ADD
BRTS2P2484LR	24 x 168 x 29	70	149	7.41	\$2278	\$229
BRTS2P2478LR	24 x 156 x 29	70	140	7.27	\$2191	\$229
BRTS2P2472LR	24 x 144 x 29	70	131	7.13	\$2123	\$223
BRTS2P2466LR	24 x 132 x 29	70	122	6.95	\$2086	\$204
BRTS2P2460LR	24 x 120 x 29	70	113	6.71	\$2037	\$204
BRTS2P2454LR	24 x 108 x 29	70	104	6.45	\$1956	\$177
BRTS2P2448LR	24 x 96 x 29	70	95	6.21	\$1839	\$158
BRTS2P3084LR	30 x 168 x 29	70	173	8.25	\$2327	\$260
BRTS2P3078LR	30 x 156 x 29	70	164	7.97	\$2225	\$238
BRTS2P3072LR	30 x 144 x 29	70	155	7.69	\$2163	\$232
BRTS2P3066LR	30 x 132 x 29	70	140	7.41	\$2105	\$223
BRTS2P3060LR	30 x 120 x 29	70	131	7.13	\$2065	\$211
BRTS2P3054LR	30 x 108 x 29	70	122	6.85	\$2006	\$177
BRTS2P3048LR	30 x 96 x 29	70	113	6.57	\$1926	\$177
BRTS3P2484LR	24 x 252 x 29	70	219	9.74	\$3235	\$362
BRTS3P2478LR	24 x 234 x 29	70	206	9.53	\$3123	\$343
BRTS3P2472LR	24 x 216 x 29	70	192	9.32	\$3021	\$334
BRTS3P2466LR	24 x 198 x 29	70	179	9.11	\$2957	\$316
BRTS3P2460LR	24 x 180 x 29	70	165	8.89	\$2892	\$306
BRTS3P2454LR	24 x 162 x 29	70	152	8.68	\$2771	\$264
BRTS3P2448LR	24 x 144 x 29	70	138	8.47	\$2595	\$236
BRTS3P3084LR	30 x 263 x 29	65	263	11.59	\$3327	\$390
BRTS3P3078LR	30 x 234 x 29	70	246	11.16	\$3174	\$358
BRTS3P3072LR	30 x 216 x 29	70	229	10.72	\$3081	\$349
BRTS3P3066LR	30 x 198 x 29	70	212	10.30	\$2994	\$334
BRTS3P3060LR	30 x 180 x 29	70	195	9.87	\$2933	\$316
BRTS3P3054LR	30 x 162 x 29	70	178	9.44	\$2845	\$264
BRTS3P3048LR	30 x 144 x 29	70	161	9.01	\$2725	\$264
BRTS4P2484LR	24 x 336 x 29	70	291	13.67	\$4203	\$483
BRTS4P2478LR	24 x 312 x 29	70	273	13.18	\$4055	\$458
BRTS4P2472LR	24 x 288 x 29	70	254	12.69	\$3919	\$445
BRTS4P2466LR	24 x 264 x 29	70	236	12.20	\$3832	\$421
BRTS4P2460LR	24 x 240 x 29	70	217	11.71	\$3733	\$421
BRTS4P2454LR	24 x 216 x 29	70	199	11.22	\$3585	\$353
BRTS4P2448LR	24 x 192 x 29	70	180	10.73	\$3313	\$353
BRTS4P3084LR	30 x 336 x 29	65	345	14.87	\$4326	\$520
BRTS4P3078LR	30 x 312 x 29	65	323	14.30	\$4123	\$476
BRTS4P3072LR	30 x 288 x 29	70	301	13.73	\$3999	\$464
BRTS4P3066LR	30 x 264 x 29	70	279	13.16	\$3882	\$445
BRTS4P3060LR	30 x 240 x 29	70	257	12.59	\$3801	\$421
BRTS4P3054LR	30 x 216 x 29	70	235	12.02	\$3684	\$353
BRTS4P3048LR	30 x 192 x 29	70	213	11.45	\$3523	\$353

Single Line 2 Person workstation consists of two worksurfaces, three leg assemblies, and two supporting structural beams. One leg can be shared by 2 adjoining worksurfaces.

Single Line 3 Person workstation consists of three worksurfaces, four leg assemblies, and three supporting structural beams. One leg can be shared by 2 adjoining worksurfaces.

Single Line 4 Person workstation consists of four worksurfaces, five leg assemblies, and four supporting structural beams. One leg can be shared by 2 adjoining worksurfaces.

Required Specifications

Finish (top)
Metal Finish (legs)

Optional Specifications

High Pressure Laminate

ROUND LEG PACKAGES

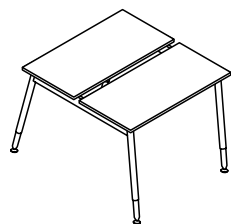

Back-to-Back 2 Person Pod with Levelers Round Leg

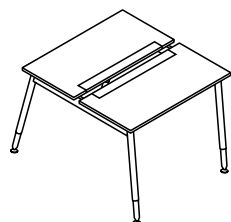

Back-to-Back 2 Person Pod with Access Door and Levelers, Round Leg

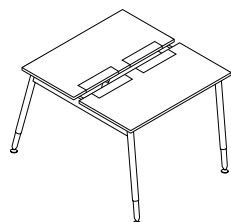

Back-to-Back 2 Person Pod with Access Door and Levelers, Round Leg

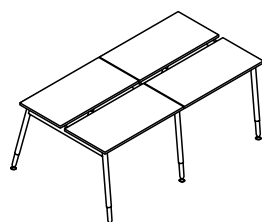

Back-to-Back 4 Person Pod with Levelers Round Leg

MODEL#	DIMENSIONS	FREIGHT CLASS	WT/LBS.	CUBIC FT.	LIST PRICE	HP ADD
--------	------------	---------------	---------	-----------	------------	--------

D x W x H

BRTBAR2P2484LR	50.5 x 84 x 29	70	146	9.40	\$2120	\$242
BRTBAR2P2478LR	50.5 x 78 x 29	85	137	9.20	\$2062	\$229
BRTBAR2P2472LR	50.5 x 72 x 29	85	128	9.02	\$1994	\$223
BRTBAR2P2466LR	50.5 x 66 x 29	85	119	8.76	\$1950	\$211
BRTBAR2P2460LR	50.5 x 60 x 29	85	110	8.56	\$1907	\$204

BRTBAR2P3084LR	62.5 x 84 x 29	70	174	10.40	\$2197	\$260
BRTBAR2P3078LR	62.5 x 78 x 29	70	163	9.80	\$2096	\$238
BRTBAR2P3072LR	62.5 x 72 x 29	70	152	9.54	\$2034	\$223
BRTBAR2P3066LR	62.5 x 66 x 29	70	141	9.25	\$1975	\$223
BRTBAR2P3060LR	62.5 x 60 x 29	85	130	9	\$1774	\$371

Back-to-back 2 Person workstation consists of two worksurfaces, two back-to-back leg assemblies, and two supporting structural beams.

BRTBAR2PA2484LR	50.5 x 84 x 29	70	146	9.40	\$2228	\$433
BRTBAR2PA2478LR	50.5 x 78 x 29	85	137	9.20	\$2182	\$387
BRTBAR2PA2472LR	50.5 x 72 x 29	85	128	9.02	\$2136	\$371
BRTBAR2PA2466LR	50.5 x 66 x 29	85	119	8.76	\$2058	\$325
BRTBAR2PA2460LR	50.5 x 60 x 29	85	110	8.56	\$1981	\$294

BRTBAR2PA3084LR	62.5 x 84 x 29	70	174	10.40	\$2414	\$526
BRTBAR2PA3078LR	62.5 x 78 x 29	70	163	9.80	\$2337	\$495
BRTBAR2PA3072LR	62.5 x 72 x 29	70	152	9.54	\$2290	\$449
BRTBAR2PA3066LR	62.5 x 66 x 29	70	141	9.25	\$2213	\$402
BRTBAR2PA3060LR	62.5 x 60 x 29	85	130	9	\$2105	\$371

Back-to-back 2 Person workstation consists of two worksurfaces, two back-to-back leg assemblies, and two supporting structural beams. Anodized aluminum worksurface door provides access to power/data trough below worksurface. Worksurface with access doors CANNOT be combined with above worksurface power trough.

BRTBAR2PDA2484LR	50.5 x 84 x 29	70	146	9.40	\$2404	\$466
BRTBAR2PDA2478LR	50.5 x 78 x 29	85	137	9.20	\$2355	\$415
BRTBAR2PDA2472LR	50.5 x 72 x 29	85	128	9.02	\$2303	\$400
BRTBAR2PDA2466LR	50.5 x 66 x 29	85	119	8.76	\$2222	\$348
BRTBAR2PDA2460LR	50.5 x 60 x 29	85	110	8.56	\$2138	\$317

BRTBAR2PDA3084LR	62.5 x 84 x 29	70	174	10.40	\$2604	\$565
BRTBAR2PDA3078LR	62.5 x 78 x 29	70	163	9.80	\$2522	\$531
BRTBAR2PDA3072LR	62.5 x 72 x 29	70	152	9.54	\$2470	\$484
BRTBAR2PDA3066LR	62.5 x 66 x 29	70	141	9.25	\$2387	\$432
BRTBAR2PDA3060LR	62.5 x 60 x 29	85	130	9	\$2270	\$401

Back-to-back 2 Person workstation consists of two worksurfaces, two back-to-back leg assemblies, and two supporting structural beams. These tables feature dual access doors providing a central connection point for monitor lifts. Anodized aluminum worksurface door provides access to power/data trough below worksurface. Worksurface with access doors CANNOT be combined with above worksurface power trough.

BRTBAR4P2484LR	50.5 x 168 x 29	70	272	15.66	\$3844	\$483
BRTBAR4P2478LR	50.5 x 156 x 29	70	256	15.20	\$3696	\$458
BRTBAR4P2472LR	50.5 x 144 x 29	70	240	14.74	\$3560	\$445
BRTBAR4P2466LR	50.5 x 132 x 29	70	224	14.28	\$3474	\$421
BRTBAR4P2460LR	50.5 x 120 x 29	70	208	13.82	\$3387	\$408

BRTBAR4P3084LR	62.5 x 168 x 29	70	333	16.86	\$3968	\$520
BRTBAR4P3078LR	62.5 x 156 x 29	70	313	16.32	\$3764	\$476
BRTBAR4P3072LR	62.5 x 144 x 29	70	293	15.78	\$3641	\$464
BRTBAR4P3066LR	62.5 x 132 x 29	70	273	15.24	\$3492	\$445
BRTBAR4P3060LR	62.5 x 120 x 29	70	253	14.70	\$3474	\$421

Back-to-back 4 Person workstation consists of four worksurfaces, three back-to-back outer leg assemblies, and four supporting structural beams.

Required Specifications

Finish (top)
Metal Finish (legs)

Optional Specifications

High Pressure Laminate

ROUND LEG PACKAGES

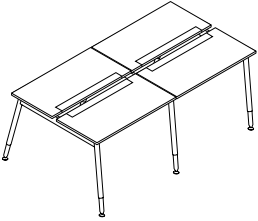

Back-to-Back 4 Person Pod with Access Door and Levelers, Round Leg

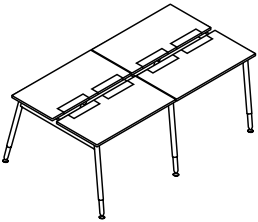

Back-to-Back 4 Person Pod with Access Door and Levelers, Round Leg

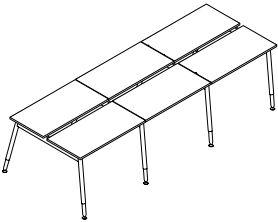

Back-to-Back 6 Person Pod with Levelers Round Leg

MODEL#	DIMENSIONS D x W x H	FREIGHT CLASS	WT/LBS.	CUBIC FT.	LIST PRICE	HP ADD
BRTBAR4PA2484LR	50.5 x 168 x 29	70	272	15.66	\$3956	\$866
BRTBAR4PA2478LR	50.5 x 156 x 29	70	256	15.20	\$3832	\$773
BRTBAR4PA2472LR	50.5 x 144 x 29	70	240	14.74	\$3739	\$742
BRTBAR4PA2466LR	50.5 x 132 x 29	70	224	14.28	\$3585	\$649
BRTBAR4PA2460LR	50.5 x 120 x 29	70	208	13.82	\$3430	\$588
BRTBAR4PA3084LR	62.5 x 168 x 29	70	333	16.86	\$4326	\$1051
BRTBAR4PA3078LR	62.5 x 156 x 29	70	313	16.32	\$4172	\$989
BRTBAR4PA3072LR	62.5 x 144 x 29	70	293	15.78	\$4079	\$897
BRTBAR4PA3066LR	62.5 x 132 x 29	70	273	15.24	\$3925	\$804
BRTBAR4PA3060LR	62.5 x 120 x 29	70	253	14.70	\$3708	\$742

Back-to-back 4 Person workstation consists of four worksurfaces, three back-to-back outer leg assemblies, and four supporting structural beams. Anodized aluminum worksurface door provides access to power/data trough below worksurface. Worksurface with access doors CANNOT be combined with above worksurface power trough.

BRTBAR4PDA2484LR	50.5 x 168 x 29	70	272	15.66	\$4381	\$930
BRTBAR4PDA2478LR	50.5 x 156 x 29	70	256	15.20	\$4247	\$831
BRTBAR4PDA2472LR	50.5 x 144 x 29	70	240	14.74	\$4147	\$797
BRTBAR4PDA2466LR	50.5 x 132 x 29	70	224	14.28	\$4055	\$698
BRTBAR4PDA2460LR	50.5 x 120 x 29	70	208	13.82	\$3814	\$631
BRTBAR4PDA3084LR	62.5 x 168 x 29	70	333	16.86	\$4746	\$1129
BRTBAR4PDA3078LR	62.5 x 156 x 29	70	313	16.32	\$4581	\$1063
BRTBAR4PDA3072LR	62.5 x 144 x 29	70	293	15.78	\$4480	\$962
BRTBAR4PDA3066LR	62.5 x 132 x 29	70	273	15.24	\$4381	\$796
BRTBAR4PDA3060LR	62.5 x 120 x 29	70	253	14.70	\$4114	\$797

Back-to-back 4 Person workstation consists of four worksurfaces, three back-to-back outer leg assemblies, and four supporting structural beams. These tables feature dual access doors providing a central connection point for monitor lifts. Anodized aluminum worksurface door provides access to power/data trough below worksurface. Worksurface with access doors CANNOT be combined with above worksurface power trough.

BRTBAR6P2484LR	50.5 x 252 x 29	70	434	22.88	\$5553	\$724
BRTBAR6P2478LR	50.5 x 234 x 29	70	409	22.10	\$5331	\$686
BRTBAR6P2472LR	50.5 x 216 x 29	70	359	21.32	\$5127	\$668
BRTBAR6P2466LR	50.5 x 198 x 29	70	329	20.54	\$4997	\$631
BRTBAR6P2460LR	50.5 x 180 x 29	70	308	19.76	\$4867	\$622
BRTBAR6P3084LR	62.5 x 252 x 29	70	493	24.53	\$5748	\$770
BRTBAR6P3078LR	62.5 x 234 x 29	70	462	23.75	\$5433	\$714
BRTBAR6P3072LR	62.5 x 216 x 29	70	431	22.86	\$5247	\$696
BRTBAR6P3066LR	62.5 x 198 x 29	70	400	21.97	\$5071	\$668
BRTBAR6P3060LR	62.5 x 180 x 29	70	369	21.08	\$4951	\$631

Back-to-back 6 Person workstation consists of six worksurfaces, four back-to-back outer leg assemblies, and six supporting structural beams.

Required Specifications

Finish (top)
Metal Finish (legs)

Optional Specifications

High Pressure Laminate

ROUND LEG PACKAGES

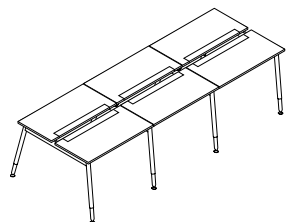

Back-to-Back 6 Person Pod with Access Door and Levelers, Round Leg

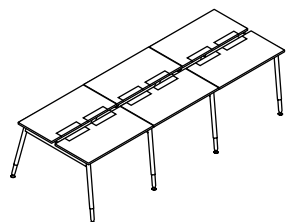

Back-to-Back 6 Person Pod with Access Door and Levelers, Round Leg

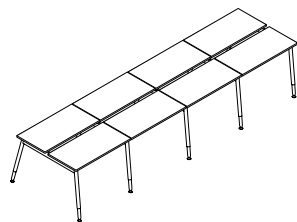

Back-to-Back 8 Person Pod with Levelers Round Leg

MODEL#	DIMENSIONS D x W x H	FREIGHT CLASS	WT/LBS.	CUBIC FT.	LIST PRICE	HP ADD
BRTBAR6PA2484LR	50.5 x 252 x 29	70	434	22.88	\$5878	\$1298
BRTBAR6PA2478LR	50.5 x 234 x 29	70	409	22.10	\$5692	\$1159
BRTBAR6PA2472LR	50.5 x 216 x 29	70	359	21.32	\$5553	\$1113
BRTBAR6PA2466LR	50.5 x 198 x 29	70	329	20.54	\$5321	\$974
BRTBAR6PA2460LR	50.5 x 180 x 29	70	308	19.76	\$5090	\$881
BRTBAR6PA3084LR	62.5 x 252 x 29	70	493	24.53	\$6388	\$1576
BRTBAR6PA3078LR	62.5 x 234 x 29	70	462	23.75	\$6156	\$1484
BRTBAR6PA3072LR	62.5 x 216 x 29	70	431	22.86	\$6017	\$1345
BRTBAR6PA3066LR	62.5 x 198 x 29	70	400	21.97	\$5785	\$1206
BRTBAR6PA3060LR	62.5 x 180 x 29	70	369	21.08	\$5461	\$1113

Back-to-back 6 Person workstation consists of six worksurfaces, four back-to-back leg assemblies, and six supporting structural beams. Anodized aluminum worksurface door provides access to power/data trough below worksurface. Worksurface with access doors CANNOT be combined with above worksurface power trough.

BRTBAR6PDA2484LR	50.5 x 252 x 29	70	434	22.88	\$6342	\$1393
BRTBAR6PDA2478LR	50.5 x 234 x 29	70	409	22.10	\$6141	\$1245
BRTBAR6PDA2472LR	50.5 x 216 x 29	70	359	21.32	\$5992	\$1195
BRTBAR6PDA2466LR	50.5 x 198 x 29	70	329	20.54	\$5740	\$1048
BRTBAR6PDA2460LR	50.5 x 180 x 29	70	308	19.76	\$5493	\$945
BRTBAR6PDA3084LR	62.5 x 252 x 29	70	493	24.53	\$6891	\$1694
BRTBAR6PDA3078LR	62.5 x 234 x 29	70	462	23.75	\$6642	\$1592
BRTBAR6PDA3072LR	62.5 x 216 x 29	70	431	22.86	\$6492	\$1443
BRTBAR6PDA3066LR	62.5 x 198 x 29	70	400	21.97	\$6240	\$1296
BRTBAR6PDA3060LR	62.5 x 180 x 29	70	369	21.08	\$5892	\$1194

Back-to-back 6 Person workstation consists of six worksurfaces, four back-to-back leg assemblies, and six supporting structural beams. These tables feature dual access doors providing a central connection point for monitor lifts. Anodized aluminum worksurface door provides access to power/data trough below worksurface. Worksurface with access doors CANNOT be combined with above worksurface power trough.

BRTBAR8P2484LR	50.5 x 336 x 29	70	556	28.30	\$7274	\$952
BRTBAR8P2478LR	50.5 x 312 x 29	70	520	27.30	\$6965	\$915
BRTBAR8P2472LR	50.5 x 288 x 29	70	484	26.30	\$6693	\$890
BRTBAR8P2466LR	50.5 x 264 x 29	70	448	25.30	\$6520	\$841
BRTBAR8P2460LR	50.5 x 240 x 29	70	412	24.42	\$6347	\$816
BRTBAR8P3084LR	62.5 x 336 x 29	70	669	30.58	\$7509	\$1039
BRTBAR8P3078LR	62.5 x 312 x 29	70	625	29.48	\$7101	\$952
BRTBAR8P3072LR	62.5 x 288 x 29	70	581	28.38	\$6854	\$927
BRTBAR8P3066LR	62.5 x 264 x 29	70	536	27.28	\$6619	\$890
BRTBAR8P3060LR	62.5 x 240 x 29	70	492	26.18	\$6459	\$841

Back-to-back 8 Person workstation consists of eight worksurfaces, five back-to-back leg assemblies, and eight supporting structural beams.

Required Specifications

Finish (top)
Metal Finish (legs)

Optional Specifications

High Pressure Laminate

ROUND LEG PACKAGES

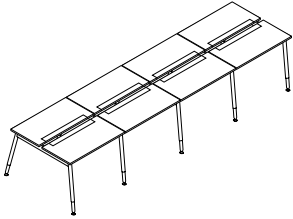

Back-to-Back 8 Person Pod with Access Door and Levelers, Round Leg

MODEL#	DIMENSIONS D x W x H	FREIGHT CLASS	WT./LBS.	CUBIC FT.	LIST PRICE	HP ADD
BRTBAR8PA2484LR	50.5 x 336 x 29	70	556	28.30	\$7695	\$1731
BRTBAR8PA2478LR	50.5 x 312 x 29	70	520	27.30	\$7447	\$1545
BRTBAR8PA2472LR	50.5 x 288 x 29	70	484	26.30	\$7262	\$1484
BRTBAR8PA2466LR	50.5 x 264 x 29	70	448	25.30	\$6953	\$1298
BRTBAR8PA2460LR	50.5 x 240 x 29	70	412	24.42	\$6644	\$1175
BRTBAR8PA3084LR	62.5 x 336 x 29	70	669	30.58	\$8374	\$2102
BRTBAR8PA3078LR	62.5 x 312 x 29	70	625	29.48	\$8065	\$1978
BRTBAR8PA3072LR	62.5 x 288 x 29	70	581	28.38	\$7880	\$1793
BRTBAR8PA3066LR	62.5 x 264 x 29	70	536	27.28	\$7571	\$1607
BRTBAR8PA3060LR	62.5 x 240 x 29	70	492	26.18	\$7138	\$1484

Back-to-back 8 Person workstation consists of eight worksurfaces, five back-to-back leg assemblies, and eight supporting structural beams. Anodized aluminum worksurface door provides access to power/data trough below worksurface. Worksurface with access doors CANNOT be combined with above worksurface power trough.

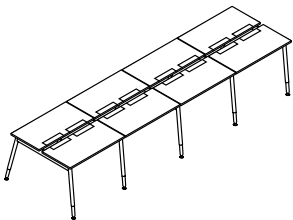

Back-to-Back 8 Person Pod with Access Door and Levelers, Round Leg

BRTBAR8PDA2484LR	50.5 x 336 x 29	70	556	28.30	\$8301	\$1860
BRTBAR8PDA2478LR	50.5 x 312 x 29	70	520	27.30	\$8035	\$1660
BRTBAR8PDA2472LR	50.5 x 288 x 29	70	484	26.30	\$7836	\$1592
BRTBAR8PDA2466LR	50.5 x 264 x 29	70	448	25.30	\$7502	\$1395
BRTBAR8PDA2460LR	50.5 x 240 x 29	70	412	24.42	\$7168	\$1262
BRTBAR8PDA3084LR	62.5 x 336 x 29	70	669	30.58	\$9035	\$2258
BRTBAR8PDA3078LR	62.5 x 312 x 29	70	625	29.48	\$8701	\$2126
BRTBAR8PDA3072LR	62.5 x 288 x 29	70	581	28.38	\$8501	\$1927
BRTBAR8PDA3066LR	62.5 x 264 x 29	70	536	27.28	\$8169	\$1726
BRTBAR8PDA3060LR	62.5 x 240 x 29	70	492	26.18	\$7702	\$1593

Back-to-back 8 Person workstation consists of eight worksurfaces, five back-to-back leg assemblies, and eight supporting structural beams. These tables feature dual access doors providing a central connection point for monitor lifts. Anodized aluminum worksurface door provides access to power/data trough below worksurface. Worksurface with access doors CANNOT be combined with above worksurface power trough.

RETURNS

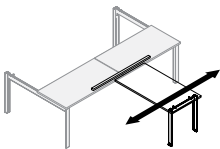

Rail Sliding Table Kit - Rectangular Legs

BRTSLDT72C	72 x 48 x 29	92.5	28.50	2.40	\$618	N/A
------------	--------------	------	-------	------	--------------	-----

Includes leg, leg support, sliding bracket hardware, 72" rail and hardware to secure table. **Worksurface not included.** Legs are for 24" d worksurfaces. 40mm dia. locking casters with 8mm thread, white body and grey tires. Maximum length of sliding table surface is 48". **Cannot be used on single line pods with rectangular legs.**

- Anodized Aluminum Leg - Add **\$54.** list upcharge



Rail Sliding Table Kit - Round Legs

BRTSLDT72CR	72 x 48 x 29	92.5	28.50	2.40	\$618	N/A
-------------	--------------	------	-------	------	--------------	-----

Includes leg, leg support, sliding bracket hardware, 72" rail and hardware to secure table. **Worksurface not included.** Legs are for 24" d worksurfaces. 3" dia. locking casters are standard. Maximum length of sliding table surface is 48".

Required Specifications

Finish (top)
Metal Finish (legs)

Optional Specifications

High Pressure Laminate (Workstations)
Anodized Aluminum Leg (Rectangular Legs)

MEETING TABLES

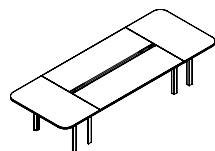

Boardroom Table with Rectangular Leg and Levelers

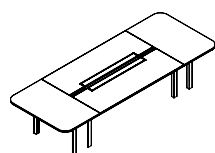

Boardroom Table with Rectangular Leg, Access Door and Levelers

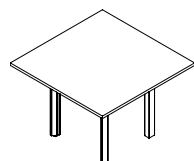

Square Meeting Table with Rectangular Legs

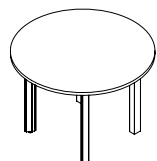

Round Meeting Table with Rectangular Legs



Gobie Table

MODEL#	DIMENSIONS	FREIGHT CLASS	WT/LBS.	CUBIC FT.	LIST PRICE	HP ADD
--------	------------	---------------	---------	-----------	------------	--------

D x W x H

BRTBRDP276L	52.5 x 276 x 29	70	474	23.42	\$6758	\$844
BRTBRDP240L	52.5 x 240 x 29	70	408	22.64	\$6499	\$788
BRTBRDP204L	52.5 x 204 x 29	70	340	20.74	\$5266	\$622
BRTBRDP180L	52.5 x 180 x 29	70	308	19.82	\$5093	\$585
BRTBRDP132L	52.5 x 132 x 29	70	228	15.02	\$3786	\$399
BRTBRDP120L	52.5 x 120 x 29	85	210	14.56	\$3699	\$381

Boardroom Table assemblies consist of 2 or more back-to-back tables with end tables on either side. Inset support legs, levelers. Worksurfaces, supporting structure and connecting hardware included.

- Anodized Aluminum Leg - Add **\$217**. list upcharge
- BRTBRDP276L consists of (6) 24" x 72" back-to-back tables and (2) 30" x 50.5" end tables
- BRTBRDP240L consists of (6) 24" x 60" back-to-back tables and (2) 30" x 50.5" end tables
- BRTBRDP204L consists of (4) 24" x 72" back-to-back tables and (2) 30" x 50.5" end tables
- BRTBRDP180L consists of (4) 24" x 60" back-to-back tables and (2) 30" x 50.5" end tables
- BRTBRDP132L consists of (2) 24" x 72" back-to-back tables and (2) 30" x 50.5" end tables
- BRTBRDP120L consists of (2) 24" x 60" back-to-back tables and (2) 30" x 50.5" end tables

BRTBRDPA276L	52.5 x 276 x 29	70	474	23.42	\$7185	\$1289
BRTBRDPA240L	52.5 x 240 x 29	70	408	22.64	\$6938	\$841
BRTBRDPA204L	52.5 x 204 x 29	70	340	20.74	\$5550	\$671
BRTBRDPA180L	52.5 x 180 x 29	70	308	19.82	\$5241	\$764
BRTBRDPA132L	52.5 x 132 x 29	70	228	15.02	\$3897	\$547
BRTBRDPA120L	52.5 x 120 x 29	85	210	14.56	\$3742	\$470

Boardroom Table assemblies consist of 2 or more back-to-back tables with end tables on either side. Inset support legs, levelers. Worksurfaces, supporting structure and connecting hardware included.

- Anodized Aluminum Leg - Add **\$217**. list upcharge
- BRTBRDPA276L consists of (6) 24" x 72" back-to-back tables and (2) 30" x 50.5" end tables
- BRTBRDPA240L consists of (6) 24" x 60" back-to-back tables and (2) 30" x 50.5" end tables
- BRTBRDPA204L consists of (4) 24" x 72" back-to-back tables and (2) 30" x 50.5" end tables
- BRTBRDPA180L consists of (4) 24" x 60" back-to-back tables and (2) 30" x 50.5" end tables
- BRTBRDPA132L consists of (2) 24" x 72" back-to-back tables and (2) 30" x 50.5" end tables
- BRTBRDPA120L consists of (2) 24" x 60" back-to-back tables and (2) 30" x 50.5" end tables

BRTSQ42L	42 x 42 x 29	70	85	4.20	\$1167	\$124
BRTSQ42C	42 x 42 x 29	70	85	4.20	\$1229	\$124

3mm edging. Select BRTSQ42L for levelers or BRTSQ42C for casters.

- Anodized Aluminum Leg - Add **\$109**. list upcharge

BRTR42L	42 x 42 x 29	70	65	3.90	\$1167	\$124
BRTR42C	42 x 42 x 29	70	65	3.90	\$1229	\$124

3mm edging. Select BRTR42L for levelers or BRTR42C for casters.

- Anodized Aluminum Leg - Add **\$109**. list upcharge

BRT24GOBE	24 x 24 x 25	250	25	9.50	\$680	\$37
-----------	--------------	-----	----	------	--------------	-------------

The Gobie circular mobile table was designed to create a portable, additional work area for laptops or paperwork. It comes standard with a pneumatic height adjustment allowing it to overlap an existing worksurface, or be tucked below a surface for storage. Tables come standard with 4 prong base and non-locking casters. Pneumatic lift provides a height adjustment between 24" and 34". Non-ganging. Shipped Fully assembled. 3" diameter casters. Matches round leg option.

Required Specifications

Finish (top)
Metal Finish (legs)

Optional Specifications

High Pressure Laminate
Anodized Aluminum Leg (*not available on Gobie Table*)

Table-edge mounted power module (Meeting Tables)

Below worksurface power trough with power distribution module (Meeting Tables)

LEG ASSEMBLIES

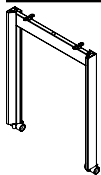

Single Rectangular Leg Assembly with Casters

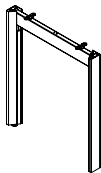

Single Rectangular Leg Assembly with Levelers

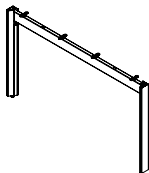

Back-to-Back Rectangular Leg Assembly with Levelers

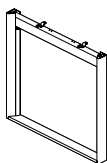

Single Loop Leg

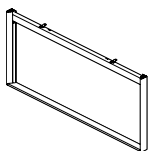

Back-to-Back Loop Leg



120° Rectangular Corner Leg Kit

MODEL#	DIMENSIONS D x W x H	FREIGHT CLASS	WT/LBS.	CUBIC FT.	LIST PRICE	HP ADD
BRTSL24C	24 x 2.5 x 28	150	8	1.34	\$340	N/A
BRTSL30C	30 x 2.5 x 28	150	8	1.41	\$387	N/A
BRTSL24C42	24 x 2.5 x 41	250	8	2.11	\$371	N/A
BRTSL30C42	30 x 2.5 x 41	250	8	2.18	\$418	N/A

Two single leg assemblies combined with support beams form the structure of the Bridges II series Single Table. One leg can be shared by two adjoining worksurfaces. 40mm white locking casters with grey tires; steel horizontal beams, aluminum legs.

- Anodized Aluminum Leg - Add **\$54**. list upcharge

BRTSL24L	24 x 2.5 x 28	150	8	1.34	\$309	N/A
BRTSL30L	30 x 2.5 x 28	150	8	1.34	\$340	N/A
BRTSL24L42	24 x 2.5 x 41	150	8	1.34	\$325	N/A
BRTSL30L42	30 x 2.5 x 41	150	8	1.34	\$356	N/A
BRTSL36	36 x 2.5 x 28	xx	9	1.50	\$343	N/A

Two single leg assemblies combined with support beams form the structure of the Bridges II series Single Table or Single Line tables. One leg can be shared by two adjoining worksurfaces. Leveling glides; steel horizontal beams, aluminum legs.

- Anodized Aluminum Leg - Add **\$54**. list upcharge

BRTBA34L	34 x 2.5 x 28	150	10	2.47	\$371	N/A
BRTBA51L	50.5 x 2.5 x 28	150	12	2.96	\$402	N/A
BRTBA63L	62.5 x 2.5 x 28	150	13	3.21	\$418	N/A

Two double leg assemblies combined with support beams form the structure of the Bridges II series Back-to-Back Table. One double leg can be shared by four adjoining worksurfaces. Leveling glides; steel horizontal beams, aluminum legs.

- Anodized Aluminum Leg - Add **\$54**. list upcharge

BRTSLL24L	24 x 2.5 x 28	92.5	11	1.01	\$353	N/A
BRTSLL30L	30 x 2.5 x 28	92.5	13.75	1.26	\$377	N/A
BRTSLL36L	36 x 2.5 x 28	92.5	16.50	1.51	\$406	N/A

Two single leg assemblies combined with support beams form the structure of the Bridges II series Single Line tables. One leg can be shared by two adjoining worksurfaces. Leveling glides; steel horizontal beams, aluminum legs.

- Anodized Aluminum Leg - Add **\$54**. list upcharge

BRTBALL51L	50.5 x 2.5 x 28	92.5	23.14	2.12	\$490	N/A
BRTBALL63L	62.5 x 2.5 x 28	92.5	28.64	2.62	\$513	N/A

Two back-to-back leg assemblies form the structure of the Bridges II series Single Line Back-to-Back Table. One double leg can be shared by four adjoining worksurfaces. Leveling glides; steel horizontal beams, aluminum legs.

- Anodized Aluminum Leg - Add **\$54**. list upcharge

BRT120L42	34 x 2.5 x 28	250	6.60	2.80	\$711	N/A
-----------	---------------	-----	------	------	--------------	-----

One 120° corner leg kit combined with two single or double leg assemblies and support beams form the structure of the Bridges II 120° Tables. 120° corner leg kit includes one corner leg and adjacent, telescopic beams to support BRTWAC120xxxx or BRTWAC120xxxxA 120° worksurfaces. Telescopic horizontal beams allow single or double leg assemblies to be positioned either under the worksurface (end of a run) or to be shared by adjoining worksurfaces. Levelers, steel horizontal beams, aluminum legs.

- Anodized Aluminum Leg - Add **\$31**. list upcharge

Required Specifications

Metal Finish (legs)

Optional Specifications

Anodized Aluminum Leg

LEG ASSEMBLIES

MODEL#	DIMENSIONS	FREIGHT CLASS	WT/LBS.	CUBIC FT.	LIST PRICE	HP ADD
	D x W x H					
BRTLVS	1 x 1 x 2.5	70	.03	.01	\$6	N/A
BRTLCS	2.6 x 2.7 x 2.5	70	.06	.01	\$25	N/A
BRTSL	24 x 3 x 28	125	8	1.25	\$328	N/A
BRTFSL	24 x 2.5 x 28	150	5	.97	\$280	N/A
BRTDL	50 x 3 x 28	150	12	2.81	\$427	N/A
BRTFDL	50 x 2.5 x 28	250	8	2.03	\$383	N/A
BRTCRL42	16 x 18 x 28	92.5	15	1.50	\$658	N/A

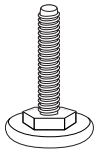
**Leveler for Rectangular Leg Table**

5/16" thread with black base. Leveler has 2" adjustment range. Casters and levelers on Rectangular legs cannot be interchanged on site.

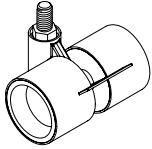
**Caster for Rectangular Leg Table**

Locking. 40mm diameter with 8mm thread, white body, light grey tires. Casters and levelers on Rectangular legs cannot be interchanged on site.

**Single Table Round Leg Assembly**

Two single table leg assemblies combined with a single beam form the supporting structure of the Bridges II series Single Line Table. One leg can be shared by two adjoining worksurfaces. Leveling Glides are standard. Locking casters are available on single tables. Specify BRTLCS

**Single Table Round Leg Assembly, Fixed Height**

Two single table leg assemblies combined with a single beam form the supporting structure of the Bridges II series Single Line Table. One leg can be shared by two adjoining worksurfaces. Leveling glides are standard.

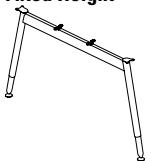
**Double Table Round Leg Assembly**

Two double table leg assemblies combined with two single beams form the supporting structure of the Bridges II series Back-to-Back Tables. One leg can be shared by two adjoining worksurfaces. Leveling Glides are standard.

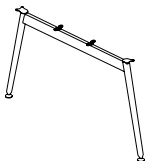
**Double Table Round Leg Assembly, Fixed Height**

Two double table leg assemblies combined with two single beams form the supporting structure of the Bridges II series Back-to-Back Tables. One leg can be shared by two adjoining worksurfaces. Leveling Glides are standard.

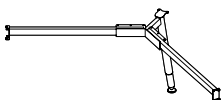
**120° Round Corner Leg Assembly**

Provides support for worksurfaces connected at 120°. Single leg and beam assembly for 120° worksurface planning. Works with BRTWAC120xxxx or BRTWAC120xxxxA 120° worksurfaces. For a single application, two BRTSL (single legs) must be added. To join a back-to-back table application, leg assembly will join to existing pod.

- When joining to an existing table, the beam extends to reach the shared leg.

Required Specifications

Metal Finish (legs)

LEG ASSEMBLIES

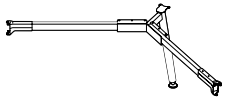

120° Fixed Height Corner Leg Assembly

MODEL#	DIMENSIONS D x W x H	FREIGHT CLASS	WT/LBS.	CUBIC FT.	LIST PRICE	HP ADD
BRTFCRL42	16 x 18 x 28	92.5	13	1.50	\$612	N/A

Provides support for worksurfaces connected at 120°, supported by fixed height legs. Single leg and beam assembly for 120° worksurface planning. Works with BRTWAC120xxxx or BRTWAC120xxxxA 120° worksurfaces. For a single application, two BRTFSL (single legs) must be added. To join a back-to-back table application, leg assembly will join to existing pod.

- When joining to an existing table, the beam extends to reach the shared leg.

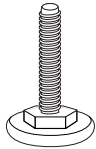

Leveler for Round Leg Table

BRTLVR	2.13 x 2.13 x 2	70	.20	.01	\$6	N/A
--------	-----------------	----	-----	-----	------------	-----

3/8" thread with black base. Leveler has 1" height adjustment range. Field retrofittable on round leg.

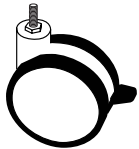

Caster for Round Leg Table

BRTLCR	1.5 x 3 x 3.75	70	.30	.01	\$25	N/A
--------	----------------	----	-----	-----	-------------	-----

Locking. 3" diameter with 3/8" -16 threaded stem. Field retrofittable on round leg.

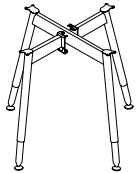

Round Table Leg Assembly

BRTRL	24 x 24 x 28	125	16	2.33	\$677	N/A
-------	--------------	-----	----	------	--------------	-----

Four leg assembly. Leveling Glides are standard. Locking casters are available. Specify (4) BRTLCR. Maximum table diameter is 42". Includes all connecting hardware.

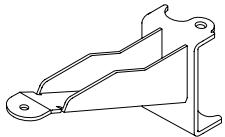

Leg Support Cantilever

BRTLSC	2 x 9 x 5	70	.50	.01	\$115	N/A
--------	-----------	----	-----	-----	--------------	-----

Provides stability for leg supports.

Required Specifications
Metal Finish (legs)

Optional Specifications
Casters (BRTRL)

BEAM APPLICATIONS

D x W x H

Table supporting structures - BEAMS

Legs are connected with supporting beams. There is one beam for a single line of tables while two beams connect back-to-back table structures. Adjustable clamps at either end of the beam can be adjusted to accommodate the following applications in both single table as well as back-to-back table configurations.

STANDARD TABLE BEAM**Single table beam application (1)**

Designed to bridge two legs to form support for a single table, or for two back-to-back worksurfaces. Adjustable clamps at either end of the beam are pushed all the way in to allow both table legs to be tucked under the worksurface.

**End of run table beam application (2)**

Supports one table leg assembly tucked under the worksurface (one adjustable clamp pushed all the way in), while the other table leg assembly can be shared between two adjacent worksurfaces (adjustable clamp pulled out to extend the beam).

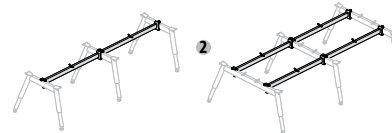
**Interconnecting table beam application (3)**

Supports both table leg assemblies extended to support adjacent worksurfaces on either side. Adjustable clamps at either end of the beam are pushed all the way in to allow both table legs to be tucked under the worksurface. Single table beam application supports single table leg assemblies with legs on both sides tucked under the worksurface.

**TELESCOPIC TABLE BEAM (4)**

Supports a return connected perpendicularly to a 24" or 30" deep primary worksurface. The Telescopic beam is connected to a single or back-to-back leg on one side and to any-worksurface supporting beam on the opposite side. Telescopic beam clamp allows the table leg to be tucked under the worksurface or shared between two adjacent worksurfaces.

**STORAGE TABLE BEAM (5)**

The Storage beam is connected to a single or back-to-back leg on one side and to the worksurface on the opposite side - thus saving one leg assembly. Assembly worksurface is connected to storage units with included storage brackets. Storage table beam's flexibility allows for a single table application (with the table leg tucked in under the worksurface) as well as for a double table installation (two adjacent tables supported by a shared leg in the middle and two storage cabinets at the opposite ends).

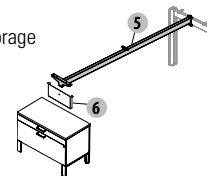
**STORAGE TABLE BEAM ADAPTER (6)**

Connects to a storage table beam. This assembly allows a worksurface to be supported by a leg on one side and a spine (formed by interconnected storage cabinets) on the opposite side.

BEAMS

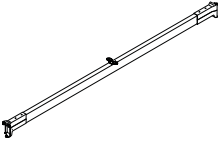

Standard Table Beam

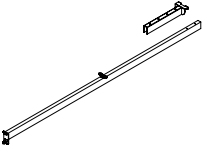

Telescopic Table Beam

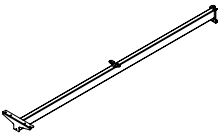

Storage Table Beam

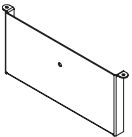

Storage Table Beam Adapter

MODEL#	DIMENSIONS D x W x H	FREIGHT CLASS	WT./LBS.	CUBIC FT.	LIST PRICE	HP ADD
BRTSB84C	1 x 79 x 2	60	8.02	.15	\$252	
BRTSB78C	1 x 73 x 2	60	7.38	.12	\$245	
BRTSB72C	1 x 67 x 2	60	6.74	.09	\$237	
BRTSB66C	1 x 61 x 2	60	6.09	.08	\$228	
BRTSB63C	1 x 57.5 x 2	60	5.72	.08	\$225	
BRTSB60C	1 x 55 x 2	60	5.45	.07	\$221	
BRTSB54C	1 x 49 x 2	60	4.86	.06	\$213	
BRTSB51C	1 x 45.5 x 2	60	4.81	.05	\$206	
BRTSB48C	1 x 43 x 2	60	4.60	.05	\$197	
BRTSB42C	1 x 37 x 2	60	3.59	.04	\$189	
BRTSB36C	1 x 31 x 2	60	3.31	.03	\$186	
BRTSB24C	1 x 19 x 2	60	2.03	.01	\$182	
BRTSB15C	1 x 10 x 2	70	1.28	.01	\$144	

Standard Table Beam bridges two legs to form support for a single table, or two back-to-back worksurfaces. Adjustable clamps at either end of the beam accommodate **standard table beam, end of run and interconnecting table beam applications**. Adjustable brackets ship attached to the beam. Specify Standard Table Beam size corresponding nominally to the worksurface length. Includes all hardware necessary to connect to legs. Powder coated steel beam and aluminum cast clamps.

BRTTB84C	1 x 96.5 x 2	60	10.32	.15	\$386	
BRTTB78C	1 x 90.5 x 2	60	9.68	.12	\$378	
BRTTB72C	1 x 84.5 x 2	60	9.04	.09	\$371	
BRTTB66C	1 x 78.5 x 2	60	8.40	.09	\$363	
BRTTB60C	1 x 72.5 x 2	60	7.75	.08	\$354	
BRTTB54C	1 x 66.5 x 2	60	7.11	.07	\$339	
BRTTB48C	1 x 60.5 x 2	60	6.74	.07	\$323	
BRTTB42C	1 x 54.5 x 2	60	5.83	.06	\$308	
BRTTB36C	1 x 48.5 x 2	60	5.19	.05	\$291	

Provides support for a worksurface connected perpendicularly to a run of primary tables. Can be adjusted to accommodate 24" and 30" primary worksurfaces. One end of the beam is attached to a Leg Assembly while the other end is secured, off module to the perpendicular Standard Table Beam, End of Run or Interconnecting Beam. Specify Telescopic Table Beam size corresponding nominally to the return worksurface length.

BRTSTB84C	1 x 80.75 x 2	60	8.64	.09	\$276	
BRTSTB78C	1 x 74.75 x 2	60	7.99	.08	\$269	
BRTSTB72C	1 x 68.75 x 2	60	7.35	.08	\$260	
BRTSTB66C	1 x 62.75 x 2	60	6.74	.07	\$252	
BRTSTB60C	1 x 54.75 x 2	60	5.85	.06	\$237	
BRTSTB54C	1 x 50.75 x 2	60	5.43	.05	\$221	
BRTSTB48C	1 x 44.75 x 2	60	4.78	.05	\$209	
BRTSTB42C	1 x 38.75 x 2	60	4.16	.04	\$206	
BRTSTB36C	1 x 32.75 x 2	60	3.50	.03	\$197	

Allows a worksurface to be supported by a leg on one side and storage tower(s) or spine of 21" and 25" interconnected storage units on the opposite side. Specify Storage Table Beam size corresponding nominally to the worksurface length. Includes all hardware necessary to connect the storage beam to the legs and worksurface.

BRTSA21	1 x 15.2 x 6.5	60	2.15	.05	\$93	
BRTSA25	1 x 15.2 x 2.75	60	4.30	.02	\$78	

Allows a worksurface to be supported by a leg on one side and storage spine on the opposite side. A typical storage spine is formed by series of Interconnected 21" or 25" storage cabinets of corresponding depth. The 21" or 25" adaptors provide structural support, acting as supports between the top of the storage cabinet spine and the bottom of the perpendicular worksurfaces. The flexible leg/beam/adaptor assembly arrangement allows the leg to be tucked in under the worksurface or to be shared by two adjacent worksurfaces. Specify Storage Beam nominally 18" shorter than worksurfaces for storage spine support application. Specify BRTSA21 or BRTSA25 depending on height of storage units forming the spine. Includes all hardware necessary to connect the adapter to the beam, worksurface and storage spine.

Required Specifications
Metal Finish

WORKSURFACES

MODEL# DIMENSIONS FREIGHT CLASS WT/LBS. CUBIC FT. LIST PRICE HP ADD

D x W x H

BRTWS2484	24 x 84 x 1	60	55	1.80	\$395	\$121
BRTWS2478	24 x 78 x 1	60	51	1.70	\$365	\$115
BRTWS2472	24 x 72 x 1	60	47	1.54	\$339	\$112
BRTWS2466	24 x 66 x 1	60	43	1.41	\$325	\$106
BRTWS2463	24 x 62.5 x 1	65	39	1.41	\$319	\$105
BRTWS2460	24 x 60 x 1	60	39	1.30	\$312	\$102
BRTWS2454	24 x 54 x 1	65	35	1.20	\$279	\$89
BRTWS2451	24 x 50.5 x 1	65	31	1.06	\$284	\$84
BRTWS2448	24 x 48 x 1	65	31	1.06	\$235	\$80
BRTWS2442	24 x 42 x 1	60	28	.90	\$197	\$65
BRTWS2436	24 x 36 x 1	60	23	.71	\$151	\$50

BRTWS3084	30 x 84 x 1	60	69	2.24	\$426	\$130
BRTWS3078	30 x 78 x 1	60	64	2.10	\$383	\$119
BRTWS3072	30 x 72 x 1	65	59	2	\$359	\$117
BRTWS3066	30 x 66 x 1	60	54	1.80	\$337	\$112
BRTWS3063	30 x 62.5 x 1	65	49	1.77	\$331	\$109
BRTWS3060	30 x 60 x 1	65	49	1.77	\$325	\$106
BRTWS3054	30 x 54 x 1	60	44	1.44	\$303	\$89
BRTWS3051	30 x 50.5 x 1	65	39	1.41	\$296	\$92
BRTWS3048	30 x 48 x 1	65	39	1.41	\$279	\$89
BRTWS3042	30 x 42 x 1	60	34	1.12	\$263	\$86
BRTWS3036	30 x 36 x 1	65	30	1.06	\$186	\$61

Flat 3 mm edge profile on all sides.

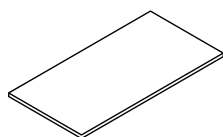

Rectangular Worksurface

BRTWSA2484	24 x 84 x 1	60	55	1.80	\$449	\$217
BRTWSA2478	24 x 78 x 1	60	51	1.70	\$426	\$193
BRTWSA2472	24 x 72 x 1	60	47	1.54	\$410	\$186
BRTWSA2466	24 x 66 x 1	60	43	1.41	\$380	\$162
BRTWSA2460	24 x 60 x 1	60	39	1.30	\$349	\$147
BRTWSA2454	24 x 54 x 1	65	35	1.20	\$309	\$140
BRTWSA2448	24 x 48 x 1	65	31	1.06	\$279	\$124
BRTWSA2442	24 x 42 x 1	60	28	.90	\$248	\$109

BRTWSA3084	30 x 84 x 1	60	69	2.24	\$534	\$263
BRTWSA3078	30 x 78 x 1	60	64	2.10	\$503	\$248
BRTWSA3072	30 x 72 x 1	65	59	2	\$488	\$224
BRTWSA3066	30 x 66 x 1	60	54	1.80	\$457	\$201
BRTWSA3060	30 x 60 x 1	65	49	1.77	\$410	\$186
BRTWSA3054	30 x 54 x 1	60	44	1.44	\$371	\$170
BRTWSA3048	30 x 48 x 1	65	39	1.41	\$333	\$147
BRTWSA3042	30 x 42 x 1	60	34	1.12	\$294	\$132

Flat 3 mm edge profile on all sides. Worksurfaces 42" to 72" w have one access door. 78" w and 84" w worksurfaces have two access doors. Access door is offset 13.5" from either side of worksurface. Anodized aluminum worksurface door provides access to power/data trough below worksurface. Worksurface with access doors CANNOT be combined with above worksurface power trough.

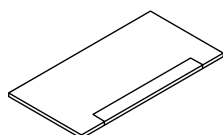

Rectangular Worksurface with Access Door

BRTWBE2451R	24 x 50.5 x 1	65	31	1.06	\$279	\$89
BRTWBE2463R	24 x 62.5 x 1	65	39	1.41	\$325	\$106
BRTWBE3051R	30 x 50.5 x 1	65	39	1.41	\$303	\$89
BRTWBE3063R	30 x 62.5 x 1	65	49	1.77	\$337	\$112

Flat 3 mm edge profile on all sides. Boardroom table extensions convert existing 24" or 30" deep back-to-back Bridges table assembly into a boardroom table. 24" and 30" d rectangular top with round corner can only be supported by 34" double leg and extension beams. *No freestanding and mobile application.*

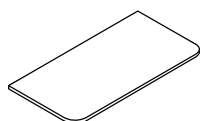

Rectangular Boardroom Table Top Extension, Round Corners

Required Specifications

Finish (top)

Optional Specifications

High Pressure Laminate

WORKSURFACES

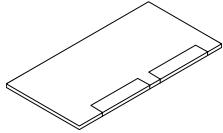

Rectangular Worksurface with 2 Access Doors

MODEL#	DIMENSIONS D x W x H	FREIGHT CLASS	WT/LBS.	CUBIC FT.	LIST PRICE	HP ADD
BRTWSAA2484	24 x 84 x 1	60	51	1.70	\$471	\$227
BRTWSAA2478	24 x 78 x 1	60	47	1.54	\$446	\$203
BRTWSAA2472	24 x 72 x 1	60	43	1.41	\$441	\$202
BRTWSAA2466	24 x 66 x 1	60	39	1.30	\$409	\$177
BRTWSAA2460	24 x 60 x 1	65	35	1.20	\$376	\$158
BRTWSAA3084	30 x 84 x 1	60	64	2.10	\$559	\$275
BRTWSAA3078	30 x 78 x 1	65	59	2	\$527	\$258
BRTWSAA3072	30 x 72 x 1	60	54	1.80	\$523	\$244
BRTWSAA3066	30 x 66 x 1	65	49	1.77	\$493	\$215
BRTWSAA3060	30 x 60 x 1	60	44	1.44	\$441	\$202

Flat 3 mm edge profile on all sides. Access doors are offset 10" (60" worksurfaces) and 13.5" (worksurfaces 66" and wider) from either side of work surface. Anodized aluminum work surface doors provide access to power/data trough below work surface. Worksurfaces with access doors CANNOT be combined with above work surface power troughs. Dimension between doors is 8" for 60" and 66" surfaces, 20" for 78", and 26" for 84".

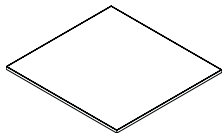

Meeting Table Top

BRTWS2451	24 x 50.5 x 1	65	31	1.06	\$284	\$90
BRTWS3051	30 x 50.5 x 1	65	39	1.41	\$296	\$93
BRTWS3651	36 x 50.5 x 1	65	43	1.71	\$441	\$72
BRTWS4251	42 x 50.5 x 1	65	48	1.93	\$488	\$129
BRTWS4851	48 x 50.5 x 1	65	52	2.07	\$555	\$143
BRTWS5151	50.5 x 50.5 x 1	65	55	2.12	\$593	\$136
BRTWS5451	54 x 50.5 x 1	65	59	2.19	\$642	\$177
BRTWS6051	60 x 50.5 x 1	65	63	2.26	\$729	\$183
BRTWS2463	24 x 62.5 x 1	65	39	1.41	\$319	\$107
BRTWS3063	30 x 62.5 x 1	65	49	1.77	\$331	\$109
BRTWS3663	36 x 62.5 x 1	65	53	1.94	\$495	\$126
BRTWS4263	42 x 62.5 x 1	65	57	2.07	\$593	\$153
BRTWS4863	48 x 62.5 x 1	65	61	2.13	\$713	\$178
BRTWS5463	54 x 62.5 x 1	65	63	2.21	\$803	\$199
BRTWS6063	60 x 62.5 x 1	65	67	2.34	\$893	\$220

Can create convenient, flexible extension of the back-to-back Bridges table assembly. Worksurfaces provided with pilot holes for alignment purposes.

- Meeting table top 50.5" long side matches 24" deep back-to-back Bridges table assembly
- Meeting table top 62.5" long side matches 30" deep back-to-back Bridges table assembly

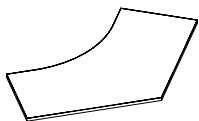

120° Worksurface

BRTWAC120424224	24 x 42 x 1	65	31	1.06	\$704	\$230
BRTWAC120424230	30 x 42 x 1	65	39	1.41	\$766	\$233

5-sided work surface can be used for a single, freestanding table, can form a pod of two or three tables, or can be combined with rectangular work surfaces to create a larger workstation.

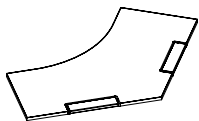

120° Worksurface with Access Door

BRTWAC120A424224	24 x 42 x 1	65	31	1.06	\$748	\$250
BRTWAC120A424230	30 x 42 x 1	65	39	1.41	\$809	\$313

5-sided work surface can be used for a single, freestanding table, can form a pod of two or three tables, or can be combined with rectangular work surfaces to create a larger workstation. Access door is offset 13.5" from either side of work surface. Anodized aluminum work surface door provides access to power/data trough below work surface. Work surface with access doors CANNOT be combined with above work surface power trough.

Required Specifications
Finish (top)

Optional Specifications
High Pressure Laminate

WORKSURFACES

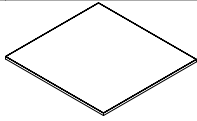

Rectangular Meeting Table Top

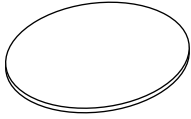

Round Meeting Table Top

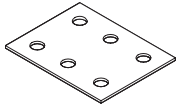

Flat Bracket

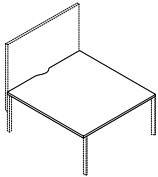

Display Wall Table Top w/Scoop

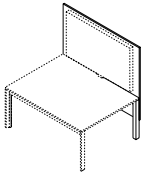

Monitor Facing Double Workstation

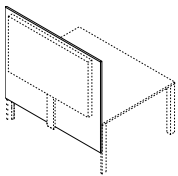

Monitor Facing Back of Double Workstation

MODEL#	DIMENSIONS	FREIGHT CLASS	WT/LBS.	CUBIC FT.	LIST PRICE	HP ADD
--------	------------	---------------	---------	-----------	------------	--------

D x W x H

BRTMT5151	50.5 x 50.5 x 1	65	55	2.12	\$557	\$309
-----------	-----------------	----	----	------	--------------	--------------

50.5" long side matches 24" d back-to-back table assembly.

BRTMTR42	42 x 42 x 1	65	40	1.76	\$371	\$92
----------	-------------	----	----	------	--------------	-------------

BHBF01	4 x 3	70	.50	.01	\$15	
--------	-------	----	-----	-----	-------------	--

Constructed of cold rolled steel. May be used to ensure alignment of neighboring worksurfaces.

BRTWS6051SCP	60 x 50.5 x 1	60	75	1.75	\$714	\$180
BRTWS5451SCP	54 x 50.5 x 1	60	68	1.58	\$629	\$174
BRTWS4863SCP	48 x 62.5 x 1	60	75	1.74	\$699	\$175

BRTWS6063SCP	60 x 62.5 x 1	60	93	2.17	\$875	\$215
BRTWS5463SCP	54 x 62.5 x 1	60	84	1.95	\$787	\$195
BRTWS4863SCP	48 x 62.5 x 1	60	75	1.74	\$699	\$175

Display wall mounts to the end of back-to-back table assembly supported by rectangular legs. As opposed to two separate back-to-back worksurfaces, the display wall table top provides one continuous, uninterrupted surface with a scoop cutout next to the display wall (the scoop facilitates cable passage from below the table). Table top 50.5" w side matches 24" d back-to-back table assemblies. Meeting table tops 62.5" w side matches 30" d back-to-back table assemblies.

BRTTVFT63	4 x 62.5 x 52	100	74	7.52	\$1398	\$511
BRTTVFT51	4 x 50.5 x 52	92.5	62	6.08	\$1323	\$439

Display wall faces the double workstation; facilitates seated presentation area. Includes laminate board, TV/display brackets (black), mounting hardware, vertical cable manager (black). Slim (22mm) bracket capable of supporting displays/TVs up to 50" (resp. 62") wide, up to 80lbs. When installed, top of the 52" x 50.5" (resp. 62.5") wide board reaches 65.5" h. 1" LP or HP laminate board with 3mm edging. Different HP laminate finishes expand product functionality. For instance white, dry-erase marker board laminate can be specified on non-display board surface. Specify laminate finish, HP laminate position (display side, non-display side) and edging. Display wall mounts to the end of back-to-back table assembly supported by rectangular legs or back-to-back table structure with BRTWSxxxxSCP Display Wall Table Top with Scoop.

- Included vertical cable manager passes through the gap between 2 back-to-back worksurfaces. Should you need one continuous, uninterrupted surface specify BRTWSxxxxSCP Display Wall Table Top with Scoop.
- Add **\$420** for white, dry erase on 51" w model, and **\$630** for 63" w

BRTTVBK63	4 x 62.5 x 52	100	74	7.52	\$1398	\$511
BRTTVBK51	4 x 50.5 x 52	92.5	62	6.08	\$1323	\$439

Display wall support board mounts to end of back-to-back table assembly supported by rectangular legs. Display faces back of the double workstation (combine with collaborative seating). Includes laminate board, TV/display brackets (black), mounting hardware, vertical cable manager (black). Slim (22mm) bracket capable of supporting displays/TVs up to 50" (resp. 62") wide, up to 80lbs. When installed, top of the 52" x 50.5" (resp. 62.5") wide board reaches 65.5" h. 1" LP or HP laminate board with 3mm edging. Different HP laminate finishes expand product functionality. For instance white, dry-erase marker board laminate can be specified on non-display board surface. Specify laminate finish, HP laminate position (display side, non-display side) and edging. Display wall mounts to the end of back-to-back table assembly supported by rectangular legs or back-to-back table structure with BRTWSxxxxSCP Display Wall Table Top with Scoop.

- Add **\$420** for white, dry erase on 51" w model, and **\$630** for 63" w

Required Specifications

Finish (top)

Optional Specifications

High Pressure Laminate

POWER DELIVERY / CABLE MANAGEMENT

D x W x H

At the basic level, table and floor based office equipment is serviced by a wall or floor power supply. As the operation grows, there might be a need to organize excessive cable clutter.

Wire Basket (1) connects to the underside of worksurfaces with sprig brackets, and cables are simply dropped and coiled into them. *Wire Basket is not to be used with power troughs.*

Cable Snake (2) Installed in proximity of floor monument to manage vertical cable clutter..

Table clamped, single circuit **Desk Top Power Data Modules (3)** deliver services to desk height, while tapping into wall or floor power supply. Again, the excessive cables can be managed with Cable Trays.

Ceiling pole **BRTCPP (4)** manages power and data cables between ceiling and above or below worksurface power troughs.

Above and Below Worksurface Power/Data Troughs (5) can be installed between back-to-back tables for extended below and above desk height power/data distribution. 8 wire, 4-circuit system. (2 + 2 circuit configuration)

NOTE: Specify **BRTHH58 (8)** to distribute power from double-sided, back-to-back below worksurface power trough to a single-sided, below worksurface power trough at the end of a table run.

Leg shroud (9) attaches to 34" w legs and manages power floor feed, as well as data cables from floor monument.

Single Sided Power/Data Troughs (6) can be installed to the underside of a single table.

Storage power/data box BRTVCM (7) attaches to storage units and provides access to one duplex/data terminal on top storage surface. Integrated single circuit module can be plugged to floor monument under the storage or to a wall outlet

4-2-2 Wiring Schematic

8-Wire Shared Neutral

"2 + 2" - 2 Utility Circuits, 2 Dedicated

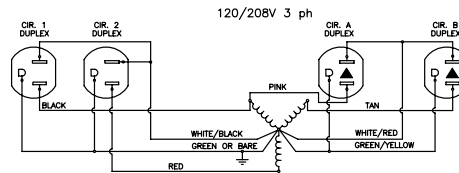
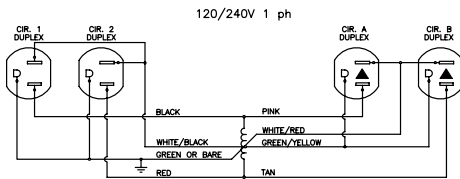

8 Wires

4 Lines (12 ga.)
2 Neutrals (10 ga.)
2 Grounds (12 ga.)

4 Circuits

2 Utility circuits
2 Dedicated Circuits

Receptacles

Duplex - Up to 12 duplex receptacles per circuit
(Up to 48 per infeed)

Specifications

System rated for connection to a grounded 120/240 V single phase, 20A, 60Hz or 120/208 V, 3 phase, 20A, 60Hz branch circuit for U.S. and 15A if product is marked with a C-UL Mark. Outlets rated 15A max.

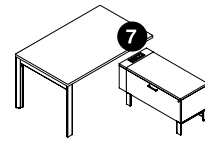
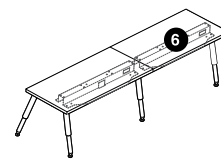
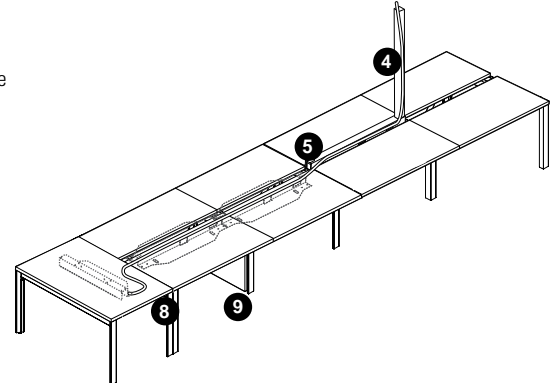
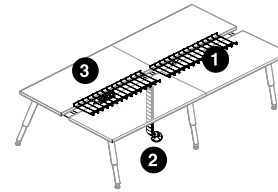

Required Specifications

Finish (top)

Optional Specifications

High Pressure Laminate

POWER DELIVERY / CABLE MANAGEMENT

MODEL#

DIMENSIONS

FREIGHT CLASS

WT./LBS.

CUBIC FT.

LIST PRICE

D x W x H

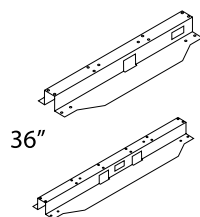

36"

42" - 72"

**Below Worksurface Single
Power/Data Trough**

BRTEETB84SKIT	11.6 x 78.34 x 2.5	100	12	1.31	\$897
BRTEETB78SKIT	11.6 x 72.34 x 2.5	100	11	1.21	\$858
BRTEETB72SKIT	11.6 x 66.34 x 2.5	100	9.80	1.11	\$557
BRTEETB66SKIT	11.6 x 60.34 x 2.5	100	8.90	1.01	\$541
BRTEETB60SKIT	11.6 x 54.34 x 2.5	100	8	.91	\$519
BRTEETB54SKIT	11.6 x 48.34 x 2.5	100	7.10	.81	\$510
BRTEETB48SKIT	11.6 x 42.34 x 2.5	100	6.20	.71	\$488
BRTEETB42SKIT	11.6 x 36.34 x 2.5	100	5.30	.61	\$449
BRTEETB36SKIT	11.6 x 30.34 x 2.5	125	4.50	.59	\$410

Formed steel trough is secured below a single table worksurface; outlets are facing the rear worksurface edge. Cannot be used on back-to-back tables. Specify Duplex receptacles separately. *Covers for duplex openings are not supplied.* 36" trough can house one duplex and 42-72" trough can house two duplexes. Specify jumpers between tables separately. Base feed entry at either end and not suitable for ceiling feed. Each trough provides one opening at 1.37" x 2.68" for terminal plate (not supplied). One terminal plate can accommodate up to 4 data/communication terminals (jacks). Data/comm plate spacer BRTPDS available to accommodate larger cable-to-terminal bending radius.

- BRTEETB36SKIT through BRTEETB72SKIT consist of one single sided steel trough, Power Distribution housing, mounting brackets and one charcoal grey extruded Data/Communication cable manager.
- BRTEETB78SKIT and BRTEETB84SKIT consist of two single-sided steel troughs, two Power Distribution Housings, mounting brackets and two charcoal grey extruded Data/Communication cable managers.
- BRTEETB78SKIT includes (1) BRTEETB36SKIT, (1) BRTEETB42SKIT and (1) JUMPER
- BRTEETB84SKIT includes (2) BRTEETB42SKIT and (1) JUMPER
- For 120° table applications, please specify BRTEETB36SKIT single trough kit for tables with BRTWAC120xx and BRTWAC120Axx worksurfaces. BRTEHH28 may be used as usual.
- Specify duplex receptacles separately
- Each trough includes one black BRTPDS Data/Comm spacer, extending the depth behind the Data/Comm opening by 0.6". White (BRTPDSW) and Silver (BRTPDSS). Data/Comm spacers are available as a special order for **\$44** list, see BRTPDS.

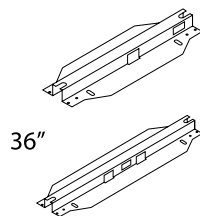

36"

42" - 72"

**Below Worksurface Double
Power/Data Trough**

BRTEETB84DKIT	8.5 x 78.3 x 2.5	92.5	9.80	.96	\$1159
BRTEETB78DKIT	8.5 x 72.3 x 2.5	92.5	9	.88	\$1144
BRTEETB72DKIT	8.5 x 66.3 x 2.5	92.5	8.30	.81	\$673
BRTEETB66DKIT	8.5 x 60.3 x 2.5	92.5	7.50	.74	\$658
BRTEETB60DKIT	8.5 x 54.3 x 2.5	92.5	6.80	.66	\$634
BRTEETB54DKIT	8.5 x 48.3 x 2.5	92.5	6	.59	\$618
BRTEETB48DKIT	8.5 x 42.3 x 2.5	92.5	5.30	.52	\$603
BRTEETB42DKIT	8.5 x 36.3 x 2.5	92.5	4.50	.44	\$580
BRTEETB36DKIT	8.5 x 30.3 x 2.5	92.5	3.80	.37	\$565

Formed steel trough is secured below worksurface; outlets between back-to-back stations supported by double table legs. Cannot be used on single table assemblies. Specify Duplex receptacles separately. *Covers for duplex openings are not supplied.* 36" trough can house one duplex per side and 42-72" trough can house two duplexes per side. Specify jumpers between tables separately. Ceiling feed entry through slots at either end; base feed entry at either end. Each trough provides one opening at 1.37" x 2.68" (one per side) for data/communication terminal plates. A single terminal plate (not supplied) can accommodate up to 4 data/communication plates. Data/comm plate spacer BRTPDS available to accommodate larger cable-to-terminal bending radius.

- BRTEETB36DKIT through BRTEETB72DKIT consist of one double-sided steel trough, Power Distribution housing, mounting brackets and one charcoal grey extruded Data/Communication cable manager.
- BRTEETB78DKIT and BRTEETB84DKIT consist of two double-sided steel troughs, two Power Distribution Housings, mounting brackets and two charcoal grey extruded Data/Communication cable managers.
- BRTEETB78DKIT includes (1) BRTEETB36DKIT, (1) BRTEETB42DKIT and (1) JUMPER
- BRTEETB84DKIT includes (2) BRTEETD42SKIT and (1) JUMPER
- Each trough includes one black BRTPDS Data/Comm spacer, extending the depth behind the Data/Comm opening by 0.6". White (BRTPDSW) and Silver (BRTPDSS). Data/Comm spacers are available as a special order for **\$44** list, see BRTPDS.

Required Specifications

Metal Finish (Power/Data Troughs)

ELECTRICAL COMPONENTS

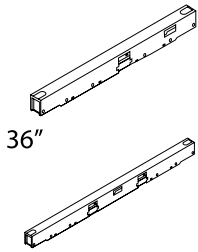

36"

42" - 72"

Above Worksurface Power Trough

MODEL#	DIMENSIONS D x W x H	FREIGHT CLASS	WT./LBS.	CUBIC FT.	LIST PRICE
BRTEETA84KIT	2.5 x 84 x 3.5	65	9.49	.42	\$1005
BRTEETA78KIT	2.5 x 78 x 3.5	65	8.81	.39	\$967
BRTEETA72KIT	2.5 x 71.9 x 3.5	65	8.12	.36	\$634
BRTEETA66KIT	2.5 x 65.9 x 3.5	65	7.45	.33	\$627
BRTEETA60KIT	2.5 x 59.9 x 3.5	65	6.77	.30	\$580
BRTEETA54KIT	2.5 x 53.9 x 3.5	65	6.09	.27	\$565
BRTEETA48KIT	2.5 x 47.9 x 3.5	65	5.41	.24	\$534
BRTEETA42KIT	2.5 x 41.9 x 3.5	65	4.73	.21	\$503
BRTEETA36KIT	2.5 x 35.9 x 3.5	65	4.06	.18	\$464

Formed steel trough is secured between back-to-back stations. Cannot be used on single table assemblies. Specify Duplex receptacles separately. *Covers for duplex openings are not supplied.* 36" trough side. Specify jumpers between tables separately. Ceiling feed entry through can house one duplex per side and 42-72" trough can house two duplexes per slots at either end; base feed entry at either end. Each trough provides two openings at 1.37" x 2.68" (one per side) for data/communication terminal plates. A single terminal plate (not supplied) can accommodate up to 4 data/comm plates. Data/comm plate spacer BRTPDS available to accommodate larger cable-to-terminal bending radius.

- BRTEETA36KIT through BRTEETA72KIT consist of one double-sided steel trough, Power Distribution Housing, mounting brackets and one charcoal grey extruded Data/Communication cable manager.
- BRTEETA78KIT and BRTEETA84KIT consist of two double-sided steel troughs, two Power Distribution Housings, mounting brackets and two charcoal grey extruded Data/Communication cable managers.
- BRTEETA78KIT includes (1) BRTEETA36KIT, (1) BRTEETA42KIT and (1) JUMPER
- BRTEETA84KIT includes (2) BRTEETA42KIT and (1) JUMPER
- Specify above worksurface power trough end cap BRTEETEC to finish open ends of the power trough
- Each trough includes one black BRTPDS Data/Comm spacer, extending the depth behind the Data/Comm opening by 0.6". White (BRTPDSW) and Silver (BRTPDSS). Data/Comm spacers are available as a special order for **\$44** list, see BRTPDS.

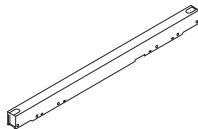

Back-to-Back Storage Tower Gap Filler Kit

BRTEST15KIT	15.5 x 2.5 x 3.5	65	2	.08	\$417
BRTEST24KIT	24 x 2.5 x 3.5	70	2.50	.12	\$453
BRTEST30KIT	31 x 2.5 x 3.5	70	3.50	.16	\$483
BRTEST48KIT	48 x 2.5 x 3.5	70	4	.24	\$533

Consists of a formed sheet metal cover and four brackets which allow the cover to be mounted at either above worksurface power trough level or below worksurface power trough level. Versatile brackets secure the cover trough at corners, to the bottom of back-to-back worksurface supported by either shared 51" or 63" legs or storage beam and storage towers.

- Note: the back-to-back storage tower gap filler is not compatible with single, freestanding tables.
- The BRTEST15kit and BRTEST24kit cover the gap between two back-to-back BRTT5024x or BRTT5030x storage towers
- The BRTEST30kit and BRTEST48kit cover the gap between two pairs of back-to-back BRTT5024x or BRTT5030x storage towers

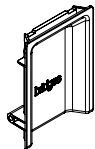

Above Worksurface Power Trough

BRTEETEC	.5 x 2.25 x 3	70	.10	.01	\$6
----------	---------------	----	-----	-----	------------

Covers the end of the worksurface power trough. Specify two per linear trough assembly. White finish only.

Required Specifications

Metal Finish (Power/Data Troughs)

ELECTRICAL COMPONENTS

MODEL# DIMENSIONS FREIGHT CLASS WT./LBS. CUBIC FT. LIST PRICE

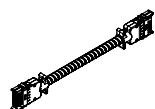

Housing to Housing Harness

	D x W x H				
BRTEHH28	.5 x 28 x 2	70	1	1.17	\$139
BRTEHH40	.5 x 40.5 x 2	70	1.10	1.25	\$150
BRTEHH44	.5 x 44.5 x 2	70	1.5	1.17	\$162
BRTEHH52	.5 x 52.5 x 2	300	2.0	1.17	\$171
BRTEHH58	.5 x 58.5 x 2	300	2.2	1.17	\$177
BRTEHH76	.5 x 76.5 x 2	250	2.8	1.17	\$198

Distributes power between Power Distribution Housings.

- BRTEHH28 distributes power between back-to-back troughs in a straight run.
- BRTEHH40 distributes power from back-to-back and single sided power troughs
- BRTEHH44 distributes power between back-to-back power troughs separated by (1) pair of storage cabinets without wardrobes. Specify BRTEST15KIT separately.
- BRTEHH52 distributes power from back-to-back power troughs separated by (1) pair of storage cabinets without wardrobes. Specify BRTEST24KIT separately.
- BRTEHH58 distributes power from back-to-back power troughs separated by (2) pairs of storage cabinets without wardrobes. Specify BRTEST30KIT separately.
- BRTEHH58 also distributes power from double-sided, back-to-back below worksurface power troughs to a single sided, below worksurface power trough at the end of a table run.
- BRTEHH76 distributes power from back-to-back power troughs separated by (2) pairs of storage cabinets without wardrobes. Specify BRTEST48KIT separately.

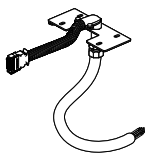

Base Feed

BRTEBF	6 x 4 x 72	250	4	2	\$430
BRTEBF120	6 x 4 x 120	250	6	2	\$600
BRTEBF144	6 x 4 x 144	150	8	2	\$645

Provides single power entry from floor or wall located building power supply. Connects to Power Distribution Housing. Must be hard wired to the building power supply by a licensed electrician.

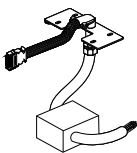

Base Feed - New York Electrical

BRTEBFK	6 x 4 x 100	250	4	2	\$675
---------	-------------	-----	---	---	--------------

Provides single power entry from floor or wall located building power supply. Connects to Power Distribution Housing. Must be hard wired to the building power supply by a licensed electrician.



Ceiling Pole

BRTCPP	1.5 x 4.75 x 99	65	13	.48	\$232
--------	-----------------	----	----	-----	--------------

Brings ceiling feed conduit and data cables from the ceiling down to Power Troughs at desk height. Accommodates 10' ceiling heights. Two part construction allows power/data conduit lay-in. Attaches to a junction between two adjacent Power Troughs. Includes mounting hardware and ceiling bezel. Painted Finish.

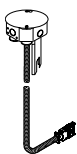

Ceiling Feed

BRTECF120	6 x 6 x 120	250	5	2	\$376
BRTECF144	6 x 6 x 144	250	5	2	\$418

Provides single power entry from ceiling, through ceiling pole into Power Trough, into Power Distribution Module. An 8 wire (4 circuit) metal conduit harness with included metal junction box for hard wiring to the building power supply above ceiling tile. Must be hard wired to the building power supply by a licensed electrician. Ceiling Pole not included.

Required Specifications

Metal Finish (BRTCPP)

ELECTRICAL COMPONENTS

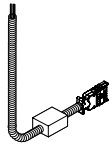

Ceiling Feed - New York Electrical

MODEL#	DIMENSIONS D x W x H	FREIGHT CLASS	WT./LBS.	CUBIC FT.	LIST PRICE
BRTECFK120	6 x 6 x 120	250	5	2	\$565
BRTECFK144	6 x 6 x 144	250	5	2	\$627

Provides single power entry from ceiling, through ceiling pole into Power Trough, into Power Distribution Module. An 8 wire (4 circuit) metal conduit harness with included metal junction box for hard wiring to the building power supply above ceiling tile. Must be hard wired to the building power supply by a licensed electrician. Ceiling Pole not included.

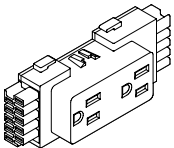

Duplex Receptacles

BRTE8D1	1.25 x 4.63 x 2	70	.10	.01	\$31
BRTE8D2	1.25 x 4.63 x 2	70	.10	.01	\$31
BRTE8DA	1.25 x 4.63 x 2	70	.10	.01	\$31
BRTE8DB	1.25 x 4.63 x 2	70	.10	.01	\$31
BRTE8DXW1	1.25 x 4.63 x 2	70	.10	.01	\$44
BRTE8DXW2	1.25 x 4.63 x 2	70	.10	.01	\$44
BRTE8DXWA	1.25 x 4.63 x 2	70	.10	.01	\$44
BRTE8DXWB	1.25 x 4.63 x 2	70	.10	.01	\$44

Snaps into Power Distribution Housing. Up to 13 duplex receptacles per circuit XW identifies white color plastic, all others standard in black.

- BRTE8D1 / BRTE8DXW1 - Circuit #1 (utility circuit)
- BRTE8D2 / BRTE8DXW2 - Circuit #2 (utility circuit)
- BRTE8DA / BRTE8DXWA - Circuit A (dedicated circuit)
- BRTE8DB / BRTE8DXWB - Circuit B (dedicated circuit)

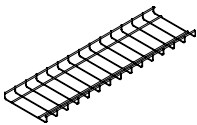

Power/Data Cable Basket

BRTCB76KIT	8 x 34 x 1	70	1.56	.15	\$207
BRTCB70	8 x 70 x 1	100	3.22	.34	\$150
BRTCB64	8 x 64 x 1	92.5	2.94	.29	\$138
BRTCB58	8 x 58 x 1	92.5	2.66	.26	\$135
BRTCB52	8 x 52 x 1	100	2.39	.24	\$126
BRTCB46	8 x 46 x 1	92.5	2.16	.21	\$120
BRTCB40	8 x 40 x 1	70	1.80	.18	\$112
BRTCB34	8 x 34 x 1	70	1.56	.15	\$108
BRTCB28	8 x 28 x 1	70	1.20	.13	\$95
BRTCB22	8 x 22 x 1	70	1.01	.10	\$89
BRTCB16	8 x 16 x 1	70	.73	.07	\$83
BRTCB8	8 x 8 x 1	70	.36	.03	\$75

Shallow, 8" wide basket manages cable excess and serves to manage cords and cables. It can be easily unclipped from spring steel brackets (included) to rearrange cable connections from below worksurface. Spring steel brackets can suspend the Cable Basket below storage cabinet's bottom where it keeps the cords and cables off the floor and manages them under storage cabinets along the horizontal plane - between floor monuments and Storage Vertical Cable Manager, for example. Tall storage cabinet's legs provide easy access to the Cable Basket where it can easily be unclipped from spring steel brackets to rearrange cable connections. Steel wire construction, chrome finish baskets; black spring steel hanging brackets, fasteners.

- Wide Cable Baskets can span under several storage cabinets. Specify Cable Basket a min. 8" shorter than the storage cabinet spine assembly.

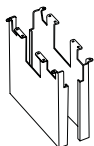

34" Leg Shroud

BRTDLSHS34	5 x 30 x 29	92.5	62	5.25	\$428
------------	-------------	------	----	------	--------------

A two part steel enclosure creates 5" deep and 30" wide cable management cavity between 34" rectangular table legs. Hides floor power feeds as well as data/communication cables rising from floor monuments to the underside of Bridges II tables. Secures to BRTBA34L rectangular leg and to underside of worksurfaces. Specify powder coat finish.

Required Specifications
Metal Finish (BRTDLSHS34)

ELECTRICAL COMPONENTS

**Cable Snake**

MODEL#	DIMENSIONS D x W x H	FREIGHT CLASS	WT/LBS.	CUBIC FT.	LIST PRICE
--------	-------------------------	---------------	---------	-----------	------------

BRTCS	2 x 8 x 30	70	3	.19	\$118
-------	------------	----	---	-----	--------------

Flexible cable management trough. Two pathways within the snake, one for data/communication and one for routing power cables. Translucent White finish only.

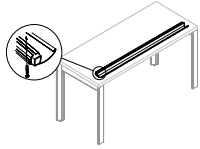
**Wire Manager**

BRTCM43	46 x 5 x 3	92.5	8	.67	\$46
BRTCM55	58 x 5 x 3	92.5	9	.85	\$55

Replacement wire manager can be added. Wire Manager neatly organizes and stores electrical and communication cables. Two lengths: 46" for tops 60" and under; 58" for tops 72". Black Plastic only.

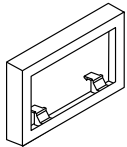
**Data/Comm Spacer**

B RTPDS	.6 x 4.75 x 2.04	70	.10	.01	\$44
B RTPDSW	.6 x 4.75 x 2.04	70	.10	.01	\$44
B RTPDSS	.6 x 4.75 x 2.04	70	.10	.01	\$44

Data/Comm plate spacer extends the depth behind data/comm jacks by 0.6" in order to accommodate larger data/comm cable bending radius. B RTPDS is Black, B RTPDSW is White and B RTPDSS is Silver.

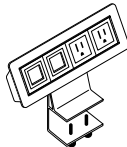
**Desktop Power/Data Module**

B RTPDMA	3 x 8 x 6	70	1	.08	\$680
----------	-----------	----	---	-----	--------------

Secures to rear edge of worksurface. Provides power - two outlets, 72"L three-prong power cord. Provides data - two coupler/jack ports; includes Voice/Data Adapter Kit to accept various couplers & jacks (not included). Top of module reaches 4" above the worksurface. White face plate, outlets and coupler/jack adapters; anodized aluminum support brackets; thumb screws, black cord.

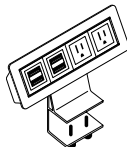
**Desktop Power/USB Module**

B RTPDMUA	3 x 8 x 6	70	1	.08	\$680
-----------	-----------	----	---	-----	--------------

Secures to rear edge of worksurface. Provides power - two outlets, 72"L three-prong power cord. Provides USB power - 4 USBA-A terminals to charge USB devices. USB cables not included. Top of module reaches 4" above the worksurface. White face plate and outlets; anodized aluminum support brackets; thumb screws, black cord.

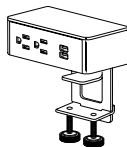
**Duo Module**

B RED50	3.2 x 5.5 x 1.8	70	2.50	.14	\$588
---------	-----------------	----	------	-----	--------------

The duo power module is completely integrated with a mounting clamp to attach to the edge of a worksurface. Provides two outlets and two 2.1 amp USB ports. White face plate, outlets and bracket; 72" long three-prong black cord, silver body.

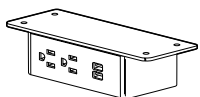
**Duo Under Module**

B REDU51	2.8 x 5.5 x 1.8	70	2.50	.14	\$516
----------	-----------------	----	------	-----	--------------

The duo under power module comes with a thin flush mounting bracket to attach to the underside of a worksurface or above worksurface shelves. Provides two outlets and two 2.1 amp USB ports. White face plate, outlets and brackets; 72" long three-prong black cord, silver body.

ELECTRICAL COMPONENTS

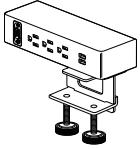

Trio Plus Module

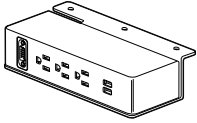

Trio Plus Under Module

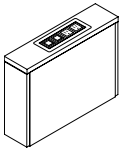

Vertical Cable Manager

MODEL#	DIMENSIONS D x W x H	FREIGHT CLASS	WT/LBS.	CUBIC FT.	LIST PRICE
BRETP53	3.2 x 8 x 1.8	70	2.50	.14	\$663

The trio plus power module is completely integrated with a mounting clamp to attach to the edge of a worksurface or above worksurface shelves. Provides three outlets and two 2.1 amp USB ports and an adapter kit containing blank cover, HDMI, RJ45 or VGA adapter brackets. Note: HDMI, RJ45 and VGA connectors are not included. White face plate, outlets, adapters and brackets; 72" long three-prong black cord.

BRETPU54	2.8 x 8 x 1.8	70	2.50	.14	\$618
----------	---------------	----	------	-----	--------------

The trio plus under power module comes with a thin flush mounting bracket to attach to the underside of a worksurface. Provides three outlets and two 2.1 amp USB ports and an adapter kit containing blank cover, HDMI, RJ45 or VGA adapter brackets. Note: HDMI, RJ45 and VGA connectors are not included. White face plate, outlets, adapters and brackets; 72" long three-prong black cord.

BRTVCM2118	18 x 6 x 21	92.5	14	1.31	\$850
BRTVCM2518	18 x 6 x 25	92.5	17	1.56	\$866
BRTVCM2124	24 x 6 x 21	100	17	1.75	\$897
BRTVCM2524	24 x 6 x 25	92.5	22	2.08	\$912

Facilitates power/data transfer from a floor monument under storage cabinets. The units can join other 18" or 24" deep storage units to form a storage spine. Removable top with a Below worksurface Power/Data Module provides easy access. Optional cable basket suspends off storage unit's bottom and manages cables along the horizontal plane. 1" top, unfinished cut-out edges. Universal connecting hardware included. Below Worksurface Power/Data Module included. Provides power - two outlets; 72"L 3-prong power cord. White face plate, outlets and coupler & jack adapters; anodized aluminum bracket supports; thumb screws, black cord. Provides data - two coupler/jack ports; includes Voice/Data Adapter Kit to accept various couplers & jacks (Not Included).

ACCESSORIES / TABLE DIVIDERS

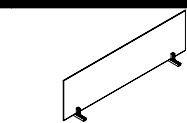

36" - 72"

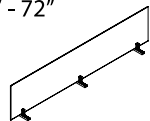

78" - 84"

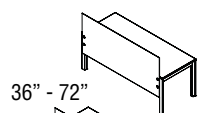
Table Divider - Glass

36" - 72"

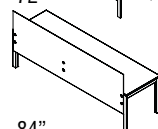

78" - 84"

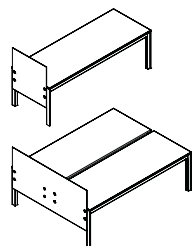
Parallel Table Divider - Glass**Perpendicular End of Run Divider - Glass**

MODEL#	DIMENSIONS	FREIGHT CLASS	WT./LBS.	CUBIC FT.	LIST PRICE
--------	------------	---------------	----------	-----------	------------

D x W x H

BRTAGDD84	.25 x 81 x 16	60	29	.18	\$689
BRTAGDD78	.25 x 75 x 16	60	27	.17	\$649
BRTAGDD72	.25 x 69 x 16	60	25	.16	\$557
BRTAGDD66	.25 x 63 x 16	60	23	.14	\$519
BRTAGDD60	.25 x 57 x 16	60	21	.13	\$479
BRTAGDD54	.25 x 51 x 16	60	18	.11	\$457
BRTAGDD48	.25 x 45 x 16	60	16	.10	\$418
BRTAGDD42	.25 x 39 x 16	60	14	.09	\$387
BRTAGDD36	.25 x 33 x 16	60	12	.07	\$349

Secures between two back-to-back tables; provides privacy, divides space. Installed divider measures 15.7" from the top of the worksurface. 36"- 72" wide dividers include 2 support brackets. 78" and 84" wide dividers include 3. Frosted tempered glass, satin chrome/white support brackets.

BRTAGDS84	.25 x 81 x 32	60	55	.35	\$1316
BRTAGDS78	.25 x 75 x 32	60	51	.33	\$1253
BRTAGDS72	.25 x 69 x 32	60	47	.30	\$1047
BRTAGDS66	.25 x 63 x 32	60	43	.28	\$984
BRTAGDS60	.25 x 57 x 32	60	39	.25	\$921
BRTAGDS54	.25 x 51 x 32	60	35	.23	\$858
BRTAGDS48	.25 x 45 x 32	60	31	.20	\$795
BRTAGDS42	.25 x 39 x 32	60	27	.18	\$732
BRTAGDS36	.25 x 33 x 32	60	23	.15	\$669

Secures to the rear edge of a single table; provides privacy, divides space while not obstructing available light. 36"- 72" wide dividers include 2 support brackets. 78" and 84" wide dividers include 3. Frosted tempered glass, satin chrome/white support brackets.

BRTAGED63	.25 x 62.5 x 32	60	35	.23	\$1379
BRTAGED51	.25 x 50.5 x 32	60	31	.20	\$1253
BRTAGED30	.25 x 30 x 32	60	27	.18	\$701
BRTAGED24	.25 x 24 x 32	60	23	.15	\$638

Secures to the rear edge of a single or double back-to-back table; provides privacy, divides space while not obstructing available light. Installed divider reaches 15.7" from the top of the worksurface and 15" below the worksurface. Rounded front top corner of 24" and 30" deep glass dividers. 51" and 63" glass dividers for back-to-back tables have both top corners rounded. 24" and 30" wide dividers include 2 support brackets; 51" and 63" wide dividers include 3. Frosted tempered glass, satin chrome/white support brackets.

TABLE DIVIDERS

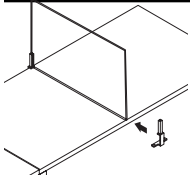

Shared Perpendicular Side to Side Divider, Middle - Glass

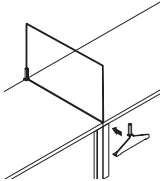

Shared Perpendicular Side to Side Divider, Seam - Glass

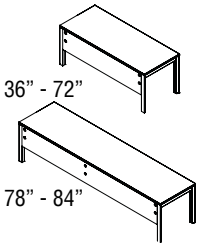

Modesty Panel - Glass

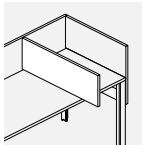

Perpendicular Laminate Side to Side Divider - Extended

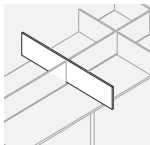

Perpendicular Laminate Side to Side Double Divider - Extended

MODEL#	DIMENSIONS D x W x H	FREIGHT CLASS	WT./LBS.	CUBIC FT.	LIST PRICE
BRTAGPPD24M	.25 x 24 x 16	60	9	.06	\$401
BRTAGPPD30M	.25 x 30 x 16	60	11.25	.07	\$420

Provides privacy, divides space while not obstructing available light. 24M and 30M kits are designed to be installed on tables with **recessed** legs (round legs, 34" rectangular legs). 24" and 30" kits consist of a wide rear bracket, narrow front bracket (white powder coated steel), tempered glass with rounded top corners (acid etched on one side), bracket-fitting gaskets and mounting screws securing the brackets to the underside of the worksurface.

BRTAGPPD24S	.25 x 24 x 16	60	9	.05	\$401
BRTAGPPD30S	.25 x 30 x 16	60	11.25	.07	\$420

Provides privacy, divides space while not obstructing available light. 24S and 30S kits are designed to be installed in the middle or over a seam of two adjacent worksurfaces supported by a shared, full depth **rectangular** leg. 24S and 30S kits consist of two wide rear brackets, wide front bracket (white powder coated steel), tempered glass with rounded top corners (acid etched on one side), bracket-fitting gaskets and mounting screws securing the brackets to the underside of the worksurface.

BRTAGMPS84	.25 x 77.75 x 13.25	60	24	.14	\$858
BRTAGMPS78	.25 x 71.75 x 13.25	60	22	.13	\$827
BRTAGMPS72	.25 x 65.75 x 13.25	60	20	.12	\$654
BRTAGMPS66	.25 x 59.75 x 13.25	60	19	.11	\$623
BRTAGMPS60	.25 x 53.75 x 13.25	60	17	.10	\$591
BRTAGMPS54	.25 x 47.75 x 13.25	60	15	.09	\$560
BRTAGMPS48	.25 x 41.75 x 13.25	60	11	.06	\$528
BRTAGMPS42	.25 x 35.75 x 13.25	60	11	.06	\$495
BRTAGMPS36	.25 x 29.75 x 13.25	60	9	.05	\$465

Secures to the rear edge of a single table, between table legs; provides privacy, Installed divider reaches 15" below the worksurface. 36" - 72" wide modesty panels include 2 mounting brackets. 78" and 84" wide modesty panels include 3 mounting brackets. Tempered glass, acid etched on one side (similar to frosted), satin chrome disc fasteners and white powder coated steel support brackets.

BRTLPE36	.75 x 36 x 16	60	11	.25	\$236
BRTLPE30	.75 x 30 x 16	60	9	.21	\$206

Protrudes by 6" beyond the front worksurface edge for added privacy. Secures off-module or on-module to the front and back edge of worksurface, regardless of type of leg support - supporting brackets can straddle over shared leg. Includes white powder coated steel support brackets. 3/4" LP PVC edge boards.

- Specify BRTLPE30 for 24" d worksurfaces and BRTLPE36 for 30" d worksurfaces

BRTLPESE75	.75 x 75 x 16	60	22	.52	\$427
BRTLPESE63	.75 x 63 x 16	60	18	.44	\$383

Protrudes by 6" beyond the front worksurface edge for added privacy. Installs on-module, between two BRTLPPD dividers. It is secured to the front edge of both worksurfaces, regardless of type of leg support - supporting brackets can straddle over shared leg. Includes white powder coated steel support brackets. 3/4" LP PVC edge boards.

- Can ONLY be installed on-module between two BRTLPPD dividers.
- Specify BRTLPESE63 for 24" d back-to-back worksurfaces and BRTLPESE75 for 30" d back-to-back worksurfaces

Required Specifications

Chassis/Accent Finish (Laminate Dividers)

TABLE DIVIDERS

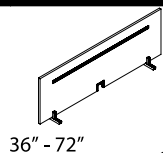

36" - 72"

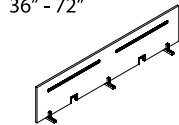

78" - 84"

Table Divider - Laminate

MODEL#	DIMENSIONS	FREIGHT CLASS	WT./LBS.	CUBIC FT.	LIST PRICE
--------	------------	---------------	----------	-----------	------------

D x W x H

BRTLPPD84	.75 x 81 x 16	60	24	.56	\$518
BRTLPPD78	.75 x 75 x 16	60	23	.52	\$501
BRTLPPD72	.75 x 69 x 16	60	21	.47	\$399
BRTLPPD66	.75 x 63 x 16	60	19	.43	\$373
BRTLPPD60	.75 x 57 x 16	60	17	.39	\$356
BRTLPPD54	.75 x 51 x 16	60	15	.35	\$339
BRTLPPD48	.75 x 45 x 16	60	14	.31	\$323
BRTLPPD42	.75 x 39 x 16	60	12	.27	\$298
BRTLPPD36	.75 x 33 x 16	60	10	.22	\$272

Secures between two back-to-back tables; provides privacy, divides space. Installed divider measures 15.7" from the top of the worksurface. 36"-72" wide dividers include 2 support brackets and one pass-through grommet. 78" and 84" wide dividers include 3 support brackets and 2 pass-through grommets. 3/4" LP self edged boards. Integrated anodized aluminum accessory rail, white cut out and rail trims; satin chrome/white support brackets.

- Please refer to the **Compatibility Guide** on pg. 386 to determine available accessories

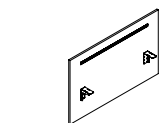

36" - 72"

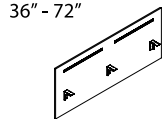

78" - 84"

High Table Divider - Laminate

BRTLPPDS84	.75 x 81 x 32	60	50	1.16	\$814
BRTLPPDS78	.75 x 75 x 32	60	47	1.08	\$780
BRTLPPDS72	.75 x 69 x 32	60	43	1	\$637
BRTLPPDS66	.75 x 63 x 32	60	40	.91	\$603
BRTLPPDS60	.75 x 57 x 32	60	36	.83	\$570
BRTLPPDS54	.75 x 51 x 32	60	32	.75	\$526
BRTLPPDS48	.75 x 45 x 32	60	29	.66	\$501
BRTLPPDS42	.75 x 39 x 32	60	25	.56	\$467
BRTLPPDS36	.75 x 33 x 32	60	22	.50	\$382

Installed on one side only. Secures to the back of a single table; provides privacy, divides space. Installed divider measures 15.7" from the top of the worksurface and 15" below the worksurface. 36"-72" wide dividers include 2 support brackets. 78" and 84" wide dividers include 4 support brackets. 3/4" self edged boards. Integrated anodized aluminum accessory rail, white cut out and rail trims; white powder coated brackets. Integrated modesty panel.

- Please refer to the **Compatibility Guide** on pg. 386 to determine available accessories

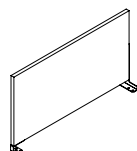

High Perpendicular Side-to-Side Divider

BRTLPPD24	.75 x 24 x 16	60	7	.16	\$187
BRTLPPD30	.75 x 30 x 16	60	9	.20	\$204

Secures off-module to front and back edges of a table; provides privacy, divides space. Can be installed anywhere along round leg supported worksurfaces. For rectangular leg installation, specify narrow BRTBA34L back-to-back leg if you need to install this divider over the seam of two adjacent worksurfaces. Installed divider measures 15.7" from the top of the worksurface. 3/4" self edged boards. Includes white powder coated steel support brackets.

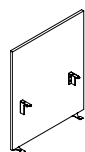

Perpendicular End of Run Divider, Laminate

BRTLPPED24	.75 x 24 x 32	60	7	.16	\$299
BRTLPPED30	.75 x 30 x 32	60	9	.20	\$323
BRTLPPED51	.75 x 50.5 x 32	60	15	.35	\$509
BRTLPPED63	.75 x 62.5 x 32	60	19	.43	\$577

Secures to the side edge of a table; provides privacy, divides space. Installed divider measures 15.7" from the top of the worksurface and 15" below the worksurface. Integrated modesty panel. 3/4" self edged boards. Includes white powder coated steel support brackets. For Rectangular leg only.

- BRTLPPED51 divider matches 24" deep back-to-back assemblies
- BRTLPPED63 divider matches 30" deep back-to-back assemblies

Required Specifications

Chassis/Accent Finish (Laminate Dividers)
Panel Fabric (Fabric Dividers)

TABLE DIVIDERS

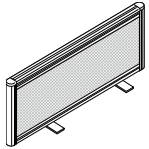

Table Divider - Fabric

MODEL#	DIMENSIONS D x W x H	YARDAGE	FREIGHT CLASS	WT/LBS.	CUBIC FT.	LIST PRICE
BR2AFD84	1.30 x 84 x 16	1	70	32	1.95	\$500
BR2AFD78	1.30 x 78 x 16	1	70	28	1.81	\$471
BR2AFD72	1.30 x 72 x 16	1	70	24	1.57	\$441
BR2AFD66	1.30 x 66 x 16	1	85	20	1.53	\$423
BR2AFD60	1.30 x 60 x 16	.50	92.5	15	1.39	\$423
BR2AFD54	1.30 x 54 x 16	.50	92.5	13	1.25	\$395
BR2AFD48	1.30 x 48 x 16	.50	85	11	.75	\$367
BR2AFD42	1.30 x 42 x 16	.50	100	9	.97	\$355
BR2AFD36	1.30 x 36 x 16	.50	100	8	.83	\$340

Attaches between Back-to-Back Tables for space division and privacy. Includes accessory rail along the top to hang accessories on both sides. Installed dividers measure 16" from the top of the worksurface. 36", 42" and 48" wide dividers include 2 brackets, all others include 3. To be used on corresponding table lengths. Extended third, central bracket can pass under worksurface access door. Dividers over 60" must have fabric railroaded.

- Please refer to the **Compatibility Guide** on pg. 386 to determine available accessories

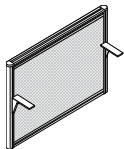
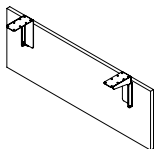

Table Divider - Fabric Table Hung

BR2AHD72	1.30 x 72 x 16	1	70	50	3	\$559
BR2AHD66	1.30 x 66 x 16	1	70	42	2.75	\$556
BR2AHD60	1.30 x 60 x 32	.60	85	36	2.50	\$566
BR2AHD54	1.30 x 54 x 32	.60	85	31	2.25	\$538
BR2AHD48	1.30 x 48 x 32	.50	85	28	2	\$515
BR2AHD42	1.30 x 42 x 32	.50	85	24	1.75	\$492
BR2AHD36	1.30 x 36 x 32	.40	85	19	1.50	\$462

Attaches to the rear edge of a table and serves as a privacy/modesty panel. Includes accessory rail along the top to hang accessories on both sides. Installed dividers measure 16" from the top of the worksurface and 15" below the worksurface. For round leg table assemblies only. To be used on corresponding table lengths. Dividers over 60" must have fabric railroaded.

- Please refer to the **Compatibility Guide** on pg. 386 to determine available accessories



Laminate Modesty Panel

MODEL#	DIMENSIONS	FREIGHT CLASS	WT/LBS.	CUBIC FT.	LIST PRICE
BRTMPS84	.75 x 78.5 x 14	60	22	.51	\$457
BRTMPS78	.75 x 72.5 x 14	60	20	.47	\$441
BRTMPS72	.75 x 66.5 x 14	60	19	.43	\$426
BRTMPS66	.75 x 60.5 x 14	60	17	.40	\$410
BRTMPS60	.75 x 54.5 x 14	60	16	.36	\$395
BRTMPS54	.75 x 48.5 x 14	60	14	.32	\$380
BRTMPS48	.75 x 42.5 x 14	60	13	.29	\$364
BRTMPS42	.75 x 36.5 x 14	60	11	.25	\$349
BRTMPS36	.75 x 30.5 x 14	60	9	.21	\$333

Secures to the back edge of a table; provides privacy, divides space. Installed divider measures 15" below the worksurface. 3/4" self edged boards. Flips down for easy access to underside of worksurface. Includes white powder coated steel support brackets.

Required Specifications

Chassis/Accent Finish (Laminate Dividers)
Panel Fabric (Fabric Dividers)

TABLE DIVIDERS

MODEL# DIMENSIONS FREIGHT CLASS WT/LBS. CUBIC FT. LIST PRICE

D x W x H

MODEL#	D x W x H	FREIGHT CLASS	WT/LBS.	CUBIC FT.	LIST PRICE
BRTPEG24	.75 x 24 x 14	60	6	.14	\$194
BRTPEG24H21	.75 x 24 x 20.5	60	9	.21	\$225
BRTPEG24H27	.75 x 24 x 26.5	60	12	.26	\$263
BRTPEG30	.75 x 30 x 14	60	8	.18	\$210
BRTPEG30H21	.75 x 30 x 20.5	60	12	.26	\$240
BRTPEG30H27	.75 x 30 x 26.5	60	15	.33	\$278
BRTPEG51	.75 x 50.5 x 14	60	13	.30	\$340
BRTPEG51H21	.75 x 50.5 x 20.5	60	20	.43	\$413
BRTPEG51H27	.75 x 50.5 x 26.5	60	26	.56	\$480
BRTPEG63	.75 x 62.5 x 14	60	16	.38	\$371
BRTPEG63H21	.75 x 62.5 x 20.5	60	25	.53	\$443
BRTPEG63H27	.75 x 62.5 x 26.5	60	32	.69	\$510

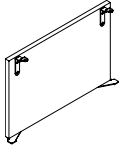
**Laminate End of Run Gable**

Perpendicular end of a run gable. Secures to the side edge of a table/tables and legs; provides privacy, divides space. 3/4" self edged boards. Includes white powder coated steel support brackets. **For Rectangular leg only.**

- BRTPEG24, 30, 51 and 63 measure 15" below worksurface
- BRTPEGxxH21 lines up with the bottom of storage cabinets
- BRTPEGxxH27 reaches down 1" from the floor (creates full panel look)

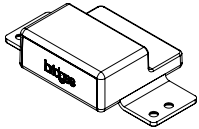
**Table End Gap Filler**

MODEL#	D x W x H	FREIGHT CLASS	WT/LBS.	CUBIC FT.	LIST PRICE
BRTTEGF	4.5 x 2.5 x 1	70	.03	.01	\$9

Injection molded block fills the gap finishing the end of back-to-back table assemblies. Secures to the bottom of two back-to-back worksurfaces. Injection molded resin, white.

Required Specifications

Chassis/Accent Finish (Laminate Dividers)

STORAGE

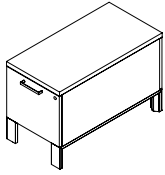

File Pedestal

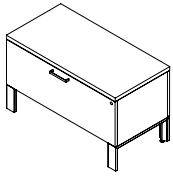

Lateral File Drawer

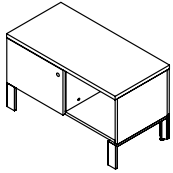

Sliding Door Storage

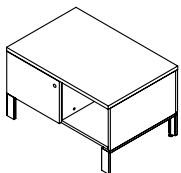

Shared Sliding Door Storage

MODEL#	DIMENSIONS D x W x H	FREIGHT CLASS	WT./LBS.	CUBIC FT.	LIST PRICE	HP ADD
BRT21BF18L	18 x 15.5 x 21	70	58	3.39	\$680	\$47
BRT21BF24L	24 x 15.5 x 21	85	64	4.52	\$788	\$47
BRT21BF30L	30 x 15.5 x 21	85	72	5.65	\$866	\$62
BRT21BF18C	18 x 15.5 x 21	70	58	3.39	\$680	\$47
BRT21BF24C	24 x 15.5 x 21	85	64	4.52	\$850	\$47
BRT21BF30C	30 x 15.5 x 21	85	72	5.65	\$927	\$62

Can join with other 21" h storage units of corresponding depth to form a spine or slide out on casters to serve as an additional worksurface. One file drawer. Fits under table beams even with optional seat cushion. Optional cable basket suspends off storage unit's bottom and manages cables and data cables under storage spine. (Leveler models only.) 1" top; metal handles; powder coated aluminum or anodized aluminum legs. Specify "L" models for levelers or "C" models for 40mm white/grey locking casters.

- Anodized Aluminum Leg - Add **\$37**. list upcharge
- 18" deep storage components will not accept legal size paper

BRT21F30L	18 x 30 x 21	92.5	77	6.56	\$912	\$62
BRT21F36L	18 x 36 x 21	92.5	84	7.87	\$1005	\$78
BRT21F42L	18 x 42 x 21	92.5	92	9.18	\$1175	\$78

Can join with other 21" h storage units of corresponding depth to form a spine. One file drawer. Optional 15.5" x 18" cushion. Optional cable basket suspends off storage unit's bottom and manages cables along the horizontal plane. 1" top; metal handles; powder coated aluminum or anodized aluminum legs.

- Anodized Aluminum Leg - Add **\$59**. list upcharge
- 18" deep storage components will not accept legal size paper

BRT21LS30L	18 x 30 x 21	100	53	6.56	\$742	\$62
BRT21LS36L	18 x 36 x 21	125	60	7.87	\$819	\$62
BRT21LS42L	18 x 42 x 21	125	67	9.18	\$897	\$62

Can join with other 21" h storage units of corresponding depth to form a spine. Optional 15.5" x 18" cushion. Storage compartment internal height: 12.36" Sliding door locks on left side. Optional cable basket suspends off storage unit's bottom and manages cables along the horizontal plane. 1" top; metal handles; powder coated aluminum or anodized aluminum legs.

- Anodized Aluminum Leg - Add **\$59**. list upcharge
- 18" deep storage components will not accept legal size paper

BRT21LSS30L	24 x 30 x 21	125	69	8.75	\$1036	\$62
BRT21LSS36L	24 x 36 x 21	125	78	10.50	\$1128	\$78
BRT21LSS42L	24 x 42 x 21	125	87	12.25	\$1221	\$93

Offers two 11" deep storage compartments on either side. For use beside a table assembly, between two adjacent workstations. Can join with other 21" h, 24" d storage units to form a spine. Optional 15.5" x 18" cushion. Storage compartment internal height: 12.36" Sliding door locks on left side. Optional cable basket suspends off storage unit's bottom and manages cables along the horizontal plane. 1" top; metal handles; powder coated aluminum or anodized aluminum legs.

- Anodized Aluminum Leg - Add **\$59**. list upcharge

Required Specifications

Metal finish

STORAGE

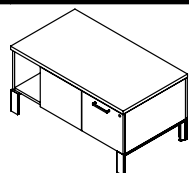

Shared File/Open Storage

MODEL#	DIMENSIONS	FREIGHT CLASS	WT./LBS.	CUBIC FT.	LIST PRICE	HP ADD
--------	------------	---------------	----------	-----------	------------	--------

D x W x H

BRT21LSO42L	24 x 42 x 21	100	124	14	\$1391	\$109
-------------	--------------	-----	-----	----	---------------	--------------

Offers storage compartments on either side. For use between two adjacent workstations. Can join with other 21”h, 24”d storage units to form a spine or serve as an additional return worksurface or ad-hoc guest seating with optional 15.5” x 18”cushion. One locking file drawer, One open compartment per side. Storage compartment internal height without shelf: 12.36”. Optional cable basket suspends off storage unit’s bottom and manages cables along the horizontal plane. 1” top; metal handles; powder coated aluminum or anodized aluminum legs.

- Anodized Aluminum Leg - Add **\$59**. list upcharge

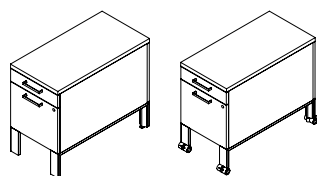

Box/File Pedestal

BRT25BF18L	18 x 15.5 x 25	70	69	3.89	\$773	\$47
BRT25BF24L	24 x 15.5 x 25	85	74	5.02	\$897	\$47
BRT25BF30L	30 x 15.5 x 25	85	82	6.15	\$974	\$62
BRT25BF18C	18 x 15.5 x 25	70	69	3.89	\$835	\$47
BRT25BF24C	24 x 15.5 x 25	85	74	5.02	\$958	\$47
BRT25BF30C	30 x 15.5 x 25	85	82	6.15	\$1036	\$62

Can join with other 25”h storage units of corresponding depth to form a spine or slide out on casters to serve as an additional worksurface. One box drawer, one file drawer. Optional cable basket suspends off storage unit’s bottom and manages cables and data cables under storage spine. (Leveler models only.) 1” top; metal handles; powder coated aluminum or anodized aluminum legs. Specify “L” models for levelers or “C” models for 40mm white/grey locking casters. Black pencil tray included.

- Anodized Aluminum Leg - Add **\$59**. list upcharge
- 18” deep storage components will not accept legal size paper

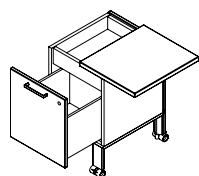

Toto 2 Mobile Storage

BRTTOTOC	18 x 15.5 x 25	70	69	4.03	\$1097	\$62
----------	----------------	----	----	------	---------------	-------------

The top slides sideways in either direction to access a laptop storage compartment and doubles as an additional worksurface. Fits below tables. One box-size compartment, one file drawer. 1” top; metal handles; powder coated aluminum or anodized aluminum legs. Specify “L” models for levelers or “C” models for 40mm white/grey locking casters.

- Anodized Aluminum Leg - Add **\$59**. list upcharge
- 18” deep storage components will not accept legal size paper

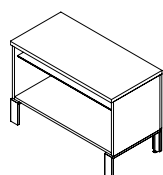

Open Storage

BRT25LO30L	18 x 30 x 25	125	49	7.81	\$541	\$109
BRT25LO36L	18 x 36 x 25	150	55	9.37	\$680	\$62
BRT25LO42L	18 x 42 x 25	150	62	10.93	\$742	\$78

One adjustable shelf. Positioned beside a table assembly or between two adjacent workstations. Can join with other 25”h, 18”d storage units to form a storage spine, credenza or serve as an additional return worksurface. Open compartment with glass adjustable shelf. Storage compartment internal height without shelf: 15.8” Optional cable basket suspends off storage unit’s bottom and manages cables along the horizontal plane. 1” top; metal handles; powder coated aluminum or anodized aluminum legs.

- Anodized Aluminum Leg - Add **\$59**. list upcharge
- 18” deep storage components will not accept legal size paper

Required Specifications

Metal finish
Finish (top)
Chassis/Accent Finish

Optional Specifications

Anodized Aluminum Leg
High Pressure Laminate (tops only)
Cable Basket

STORAGE

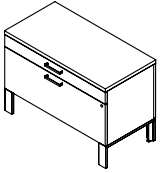

Lateral Box/File Storage Unit

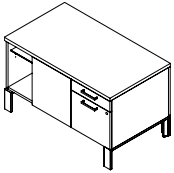

Shared Storage Unit

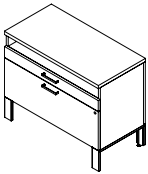

Lateral Box/File Open Storage Unit

MODEL#	DIMENSIONS D x W x H	FREIGHT CLASS	WT/LBS.	CUBIC FT.	LIST PRICE	HP ADD
BRT25LBF30L	18 x 30 x 25	92.5	88	7.81	\$1051	\$62
BRT25LBF36L	18 x 36 x 25	92.5	96	9.37	\$1206	\$62
BRT25LBF42L	18 x 42 x 25	100	104	10.93	\$1314	\$78

Positioned beside a table assembly or between two adjacent workstations. Can join with other 25”h, 18”d storage units to form a storage spine, credenza or serve as an additional return worksurface. One locking file drawer, one box drawer. Optional cable basket suspends off storage unit’s bottom and manages cables along the horizontal plane. 1” top; metal handles; powder coated aluminum or anodized aluminum legs. Black pencil tray included.

- Anodized Aluminum Leg - Add **\$59**. list upcharge
- 18” deep storage components will not accept legal size paper

BRT25LBF042L	24 x 42 x 25	100	154	16.66	\$1746	\$93
--------------	--------------	-----	-----	-------	---------------	-------------

Offers storage compartments on either side. For use between two adjacent workstations. Can join with other 25”h, 24”d storage units to form a spine or serve as an additional return worksurface or ad-hoc guest seating with optional 15.5” x 18”cushion. One locking file drawer, One open compartment per side. Storage compartment internal height without shelf: 12.36”. Optional cable basket suspends off storage unit’s bottom and manages cables along the horizontal plane. 1” top; metal handles; powder coated aluminum or anodized aluminum legs. Black pencil tray included.

- Anodized Aluminum Leg - Add **\$59**. list upcharge

BRT29LOBF30L	18 x 30 x 29	92.5	100	9.06	\$1199	\$53
BRT29LOBF36L	18 x 36 x 29	92.5	111	10.87	\$1345	\$78
BRT29LOBF42L	18 x 42 x 29	100	122	12.68	\$1499	\$93

Positioned beside a table assembly or between two adjacent workstations. Units are level with Bridges tops and can join other 29”h, 18”d storage units to form a credenza or serve as an additional return worksurface. One locking file drawer, one box drawer and one open compartment. Storage compartment internal height: 3.9”. Optional cable basket suspends off storage unit’s bottom and manages cables along the horizontal plane. 1” top; metal handles; powder coated aluminum or anodized aluminum legs. Black pencil tray included.

- Anodized Aluminum Leg - Add **\$59**. list upcharge
- 18” deep storage components will not accept legal size paper

Required Specifications

Finish (top)
Chassis/Accent Finish
Metal Finish (legs)

Optional Specifications

Anodized Aluminum Leg
High Pressure Laminate (tops only)
Cable Basket
Cushion (BRT21LS042L)

STORAGE

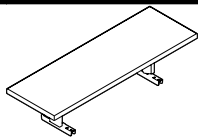

Center Mount Shelf

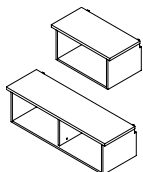
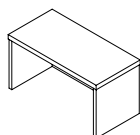
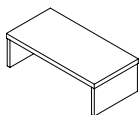

Table Mounted End Shelf



Single Sided Elevated Table Shelf

MODEL#	DIMENSIONS	FREIGHT CLASS	WT./LBS.	CUBIC FT.	LIST PRICE	HP ADD
--------	------------	---------------	----------	-----------	------------	--------

D x W x H

BRTCMS36	12 x 36 x 6.75	100	15.20	1.69	\$294	N/A
BRTCMS30	12 x 30 x 6.75	100	12.60	1.41	\$206	N/A

Open, shared center mount shelf “floats” 6.75” above the gap formed by two back-to-back worksurfaces. Accepts BRTESSBIN Elevated Shelf Binder Bin - The 30”w shelf accommodates two; 36”w shelf accommodates up to three. Shelves overhang the support structure by 6” on either side. Aluminum/die cast structure attaches to the underside of both worksurfaces.

- Not compatible with BRTEETA Above Worksurface Power Trough and Worksurfaces with Access Doors
- Anodized Aluminum support structure - Add **\$59** list upcharge

BRTTES24	15.5 x 24 x 15	100	29	3.22	\$572	\$47
BRTTES30	15.5 x 30 x 15	100	34	4.03	\$627	\$54
BRTTES51	15.5 x 50.5 x 15	100	57	6.79	\$1036	\$101
BRTTES63	15.5 x 62.5 x 15	100	68	8.40	\$1137	\$131

Single or double open shelf/extended worksurface. Secured to the end of single or back-to-back Bridges table. All mounting hardware included. Storage compartment internal height: 13.25”. 1” top.

BRTSTS0824	12 x 24 x 8	92.5	14	1.33	\$201	\$62
BRTSTS0830	12 x 30 x 8	100	16	1.66	\$232	\$62
BRTSTS0851	12 x 50.5 x 8	100	25	2.80	\$371	\$93
BRTSTS0863	12 x 62.5 x 8	100	28	3.47	\$418	\$140

BRTSTS1324	12 x 24 x 13	100	18	2.16	\$217	\$62
BRTSTS1330	12 x 30 x 13	125	21	2.70	\$248	\$62
BRTSTS1351	12 x 50.5 x 13	125	32	4.55	\$371	\$93
BRTSTS1363	12 x 62.5 x 13	125	38	5.64	\$433	\$124

BRTSTS1624	12 x 24 x 16	125	19	2.66	\$248	\$62
BRTSTS1630	12 x 30 x 16	100	29	3.33	\$294	\$62
BRTSTS1651	12 x 50.5 x 16	150	33	5.61	\$433	\$109
BRTSTS1663	12 x 62.5 x 16	150	39	6.94	\$495	\$140

Secured perpendicularly to the single or back-to-back Bridges table. Integrated anodized aluminum accessory rail. White cut out and accessory rail trims. Optional Elevated Shelf Binder Bin (BRTESSBIN) rests on top surface for enhanced privacy. 8”h provides additional storage space without obstructing view and reaches 16” module height when combined w/8”h Binder shelf. Internal height: 6.6”. 16”h lines up with top of 16” table dividers (15.8”). Specify 12” narrower shared elevated shelf immediately adjacent to the perpendicular elevated shelf. Internal height: 14.6”.

- Please refer to the **Compatibility Guide** on pg. 386 to determine available accessories

Required Specifications

Finish (top)
Chassis/Accent Finish
Metal Finish (legs)

Optional Specifications

Anodized Aluminum Leg
High Pressure Laminate (tops only)
Cable Basket (Storage Units)
Elevated Shelf Binder Bin (shared storage)

STORAGE

MODEL#	DIMENSIONS	FREIGHT CLASS	WT./LBS.	CUBIC FT.	LIST PRICE	HP ADD
--------	------------	---------------	----------	-----------	------------	--------

D x W x H

BRTBTS0836	12 x 36 x 8	100	16	2	\$309	\$62
BRTBTS0842	12 x 42 x 8	100	19	2.33	\$340	\$62
BRTBTS0848	12 x 48 x 8	125	21	2.66	\$371	\$93
BRTBTS0854	12 x 54 x 8	125	23	3	\$387	\$109
BRTBTS0860	12 x 60 x 8	125	26	3.33	\$433	\$124
BRTBTS0866	12 x 66 x 8	125	28	3.66	\$464	\$140
BRTBTS0872	12 x 72 x 8	125	30	4	\$495	\$140
BRTBTS0878	12 x 78 x 8	125	32	4.33	\$526	\$155
BRTBTS0884	12 x 84 x 8	125	35	4.66	\$557	\$170
BRTBTS1336	12 x 36 x 13	125	22	3.25	\$371	\$78
BRTBTS1342	12 x 42 x 13	125	25	3.79	\$418	\$78
BRTBTS1348	12 x 48 x 13	125	28	4.33	\$449	\$109
BRTBTS1354	12 x 54 x 13	125	30	4.87	\$495	\$109
BRTBTS1360	12 x 60 x 13	150	33	5.86	\$526	\$109
BRTBTS1366	12 x 66 x 13	150	36	6.45	\$541	\$186
BRTBTS1372	12 x 72 x 13	125	39	6.50	\$618	\$155
BRTBTS1378	12 x 78 x 13	150	42	7.04	\$665	\$155
BRTBTS1384	12 x 84 x 13	150	44	7.58	\$711	\$170
BRTBTS1636	12 x 36 x 16	125	25	4	\$387	\$62
BRTBTS1642	12 x 42 x 16	125	28	4.66	\$433	\$93
BRTBTS1648	12 x 48 x 16	150	31	5.33	\$479	\$93
BRTBTS1654	12 x 54 x 16	150	34	6	\$510	\$124
BRTBTS1660	12 x 60 x 16	150	38	6.66	\$557	\$124
BRTBTS1666	12 x 66 x 16	150	41	7.33	\$603	\$124
BRTBTS1672	12 x 72 x 16	150	44	8	\$649	\$140
BRTBTS1678	12 x 78 x 16	150	47	8.66	\$680	\$155
BRTBTS1684	12 x 84 x 16	150	50	9.33	\$727	\$170

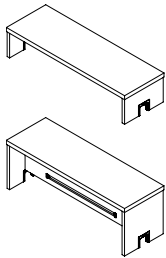

Shared Elevated Table Shelf

Rests on back-to-back Bridges tables. Cut outs in both supporting side gables allow placement over above worksurface power/data troughs. Integrated anodized aluminum accessory rail. White cut out and accessory rail trims. Three heights available. 8”h provides additional storage space without obstructing view; reaches 16” module height when combined w/8”h Binder shelf. Internal height: 6.6”. 16”h lines up with top of 16” table dividers (15.8”). Specify 12” narrower shared elevated shelf immediately adjacent to the perpendicular elevated shelf. Internal height: 14.6”. Optional Elevated Shelf Binder Bin (BRTESBBIN) rests on top surface for enhanced privacy. 1” top.

- Please refer to the **Compatibility Guide** on pg. 386 to determine available accessories

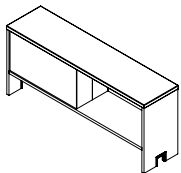

Table Supported Shared Overhead

BRTBAS048	12 x 48 x 21	125	54	7	\$618	\$93
-----------	--------------	-----	----	---	--------------	-------------

One compartment per side. White magnetic back wall. Lines up with 50”h floor standing storage. Fits over the gap between two parallel back-to-back Bridges tables. Fits over worksurface power/data trough. Storage compartment internal height: 12.8”. Optional Elevated Shelf Binder Bin (BRTESBBIN) rests on top surface for enhanced privacy. 1” top.

- Please refer to the **Compatibility Guide** on pg. 386 to determine available accessories

Required Specifications

Finish (top)
Chassis/Accent Finish

Optional Specifications

High Pressure Laminate (tops only)
Elevated Shelf Binder Bin

STORAGE

MODEL# DIMENSIONS FREIGHT CLASS WT./LBS. CUBIC FT. LIST PRICE HP ADD

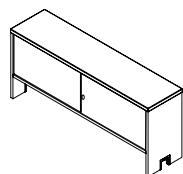

Shared Elevated Overhead

	D x W x H					
BRTBASL36	16 x 36 x 21	250	23.50	6.56	\$1791	\$117
BRTBASL42	16 x 42 x 21	250	27.50	7.65	\$1917	\$144
BRTBASL48	16 x 48 x 21	250	31.40	8.75	\$2016	\$171
BRTBASL54	16 x 54 x 21	250	35.30	9.84	\$2169	\$180
BRTBASL60	16 x 60 x 21	250	35.30	9.84	\$2288	\$187
BRTBASL66	16 x 66 x 21	250	43.20	12.03	\$2583	\$216
BRTBASL72	16 x 72 x 21	250	47.10	13.12	\$2718	\$243
BRTBASL78	16 x 78 x 21	250	51	14.21	\$2862	\$261
BRTBASL84	16 x 84 x 21	250	55	15.31	\$2898	\$360

Two compartments facing in opposite direction can be locked with sliding glass doors. Storage compartment internal height: 12.25". Shared elevated overhead fits over the gap between two parallel Bridges back-to-back tables. Integrated anodized aluminum accessory rail below the storage compartments. Fits over Above Worksurface Power/Data Troughs. Elevated Shelf Binder Bins DO NOT work with this overhead. 1" top.

- Note: In order to prevent duplex outlet and worksurface access door interference, please specify Overhead of the same width as the supporting worksurface.
- To prevent interference with Ceiling feed pole, please specify Overhead 6" shorter in width corresponding with the length of the supporting worksurface.
- Please refer to the **Compatibility Guide** on pg. 386 to determine available accessories

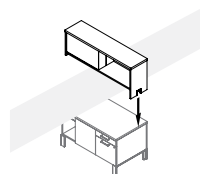

45" High Shared Storage Divider

BRTSDS48	12 x 48 x 16	92.5	54	5.33	\$495	\$93
----------	--------------	------	----	------	--------------	-------------

Divides side-to-side workstations. Two shared, open shelves. One compartment per side. White magnetic back wall. Rests on top of shared 25" box/file/open and back-to-back worksurface. Top of unit is 15.7" from the top of the worksurface. Storage compartment internal height: 12.8". Optional Elevated Shelf Binder Bin (BRTESSBBIN) rests on top surface for enhanced privacy. 1" top, white powder-coated steel central partition and backs.

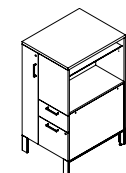

50" H Storage Tower with Coat Storage

BRTTW5024L	24 x 24 x 50	100	142	16.66	\$1685	\$109
BRTTW5024R	24 x 24 x 50	100	142	16.66	\$1685	\$109
BRTTW5030L	30 x 24 x 50	125	163	20.83	\$1870	\$109
BRTTW5030R	30 x 24 x 50	125	163	20.83	\$1870	\$109

Provides storage and privacy at the end of a table. Box/File drawers, open compartment with adjustable shelf (50"h); coat storage with hinged door. Specify Left or Right handed. Capable of supporting worksurface on one side. Built-in threaded inserts to secure dedicated worksurface supporting beam. Open side storage compartment internal height: 19.6". Optional cable basket suspends off storage unit's bottom and manages cables along the horizontal plane. 1" top; metal handles; powder-coated aluminum or anodized aluminum legs. Black pencil tray included.

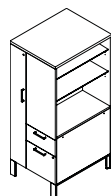

66" H Storage Tower with Coat Storage

BRTTW6624L	24 x 24 x 66	125	170	22	\$2234	\$142
BRTTW6624R	24 x 24 x 66	125	170	22	\$2234	\$142
BRTTW6630L	30 x 24 x 66	125	195	27.50	\$2478	\$143
BRTTW6630R	30 x 24 x 66	125	195	27.50	\$2478	\$173

Provides storage and privacy at the end of a table. Box/File drawers, open compartment with 2 adjustable shelves (66"h); coat storage with hinged door and 2 shelves. Specify Left or Right handed. Capable of supporting worksurface on one side. Built-in threaded inserts to secure dedicated worksurface supporting beam. Open side storage compartment internal height: 35.6". Optional cable basket suspends off storage unit's bottom and manages cables along the horizontal plane. 1" top; metal handles; powder-coated aluminum or anodized aluminum legs. Black pencil tray included.

Required Specifications

Finish (top)
Chassis/Accent Finish

Optional Specifications

High Pressure Laminate (tops only)
Elevated Shelf Binder Bin (shared storage)

STORAGE

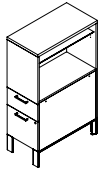

50" H Storage Tower

MODEL#	DIMENSIONS D x W x H	FREIGHT CLASS	WT/LBS.	CUBIC FT.	LIST PRICE	HP ADD
BRTT5024L	24 x 15.5 x 50	100	88	10.76	\$1252	\$78
BRTT5024R	24 x 15.5 x 50	100	88	10.76	\$1252	\$78
BRTT5030L	30 x 15.5 x 50	125	101	13.45	\$1376	\$93
BRTT5030R	30 x 15.5 x 50	125	101	13.45	\$1376	\$93

Provides storage and privacy at the end of a table. Box/File drawers, open compartment with adjustable shelf (50"h). Specify Left or Right handed. Capable of supporting worksurface on one side. Built-in threaded inserts to secure dedicated worksurface supporting beam. Open side storage compartment internal height: 19.6". Optional cable basket suspends off storage unit's bottom and manages cables along the horizontal plane. 1" top; metal handles; powder-coated aluminum or anodized aluminum legs. Black pencil tray included.

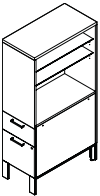

66" H Storage Tower

BRTT6624L	24 x 15.5 x 66	100	106	12.91	\$1659	\$102
BRTT6624R	24 x 15.5 x 66	100	106	12.91	\$1659	\$102
BRTT6630L	30 x 15.5 x 66	125	121	16.14	\$1824	\$123
BRTT6630R	30 x 15.5 x 66	125	121	16.14	\$1824	\$123

Provides storage and privacy at the end of a table. Box/File drawers, open compartment with 2 adjustable glass shelves (66"h). Specify Left or Right handed. Capable of supporting worksurface on one side. Built-in threaded inserts to secure dedicated worksurface supporting beam. Open side storage compartment internal height: 35.6". Optional cable basket suspends off storage unit's bottom and manages cables along the horizontal plane. 1" top; metal handles; powder-coated aluminum or anodized aluminum legs. Black pencil tray included.

ACCESSORIES

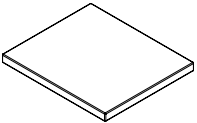

Cushion

					GRADE	LIST	GRADE	LIST
BRTC	18 x 15.5 x 1	70	1	.41	1	\$200	7	\$386
					2	\$226	8	\$418
					3	\$248	9	\$455
					4	\$274	10	\$494
					5	\$312	11	\$544
					6	\$349	12	\$617

Optional seat cushion may be added to any storage component. Available in all Global seating fabrics.

• **When added to 25" h storage units, unit will NOT fit under any table with a beam**

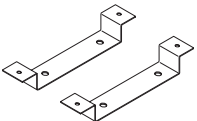

Glide Tray Adapter

GAGTA01	2 x 9 x 2.5	70	.50	.03	\$90
---------	-------------	----	-----	-----	-------------

Accommodates the placement of sliding keyboard mechanisms and CPU holders below the cross beam of Bridges tables. Attaches to Glide Tracks of all Productivity Solutions Keyboard Mechanisms and Sliding CPU holders. Mounting hardware included. Available in black only.

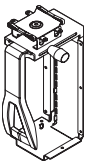

Fixed Mount CPU Holder

GACPU01	9.5 x 11.7 x 18.5	100	9.0	1.15	\$180
---------	-------------------	-----	-----	------	--------------

Fully adjustable clamping mechanism to accept tower CPUs with a height range of 12.5" to 22.5" and width range of 3.5" to 9.3". Soft touch knob for side clamp adjustment and bayonet lance for vertical height adjustment. Mounts directly to underside of desk surface. CPU Holder can also be mounted directly to an upright desk leg surface or wall via side mounting holes. Manufactured from Steel and Engineered Resin, providing rugged durability and support. Available in black only.

Required Specifications

Finish (top)
Metal finish (legs)
Fabric (cushion)

Optional Specifications

Anodized Aluminum Leg
High Pressure Laminate

ACCESSORIES

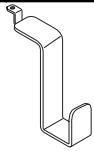
**Hanging Bracket**

MODEL# DIMENSIONS FREIGHT CLASS WT./LBS. CUBIC FT. LIST PRICE

MODEL#	D x W x H	FREIGHT CLASS	WT./LBS.	CUBIC FT.	LIST PRICE
BRTHB	3.3 x 1.5 x 3.5	70	.20	.01	\$23

A formed steel bracket hooks over Bridges II table leg. Can be secured either on the inner or outer side of the leg. Specify frame finish.

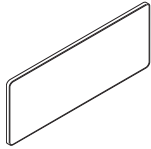
**Whiteboard**

BRTWB0924	0.5 x 24 x 8.5	70	1	.56	\$200
-----------	----------------	----	---	-----	--------------

White dry-erase marker board surface on white powder coated steel backer. Fits 16" tall Bridges II dividers and single-sided shelves. White dry-erase surface attaches magnetically to the steel backer. When removed, the steel backer can be used as a magnetic board. *Please refer to the **Compatibility Guide** (pg. 386) to determine available accessories.*

- Available in Tungsten (TUN) or Designer White (DWT) Only

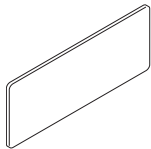
**Tackboard**

BRTTB0924	0.5 x 24 x 8.5	70	1	.56	\$200
-----------	----------------	----	---	-----	--------------

Grey tackboard surface on white powder coated steel backer. Fits 16" tall Bridges II dividers and single-sided shelves. *Please refer to the **Compatibility Guide** (pg. 386) to determine available accessories.*

- Available in Tungsten (TUN) or Designer White (DWT) Only

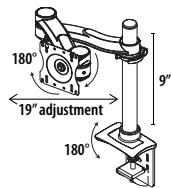
**Single Screen Double Extension Arm**

GAMCSSDE	-- x -- x --	125	7.50	1.09	\$452
----------	--------------	-----	------	------	--------------

Double extension allows 19" of horizontal back and forth movement. Arm folds back to post for more desk space. Displays are able to tilt 180°, swing 180° side-to-side and rotate from landscape to portrait. Minor assembly required.

- Short clamp allows arm to be clamped on rear worksurface edge in conjunction with BRTEETxxxDKIT power troughs

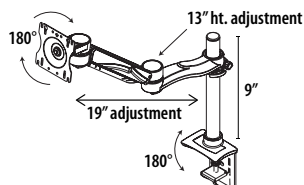
**Single Screen Double Extension Arm with Height Adjustment**

GAMCSSDEH	-- x -- x --	125	8.20	1.09	\$543
-----------	--------------	-----	------	------	--------------

Counterbalanced arm provides an additional 13" of height adjustment. Double extension allows 19" of horizontal back and forth movement. Easy to use Allen wrench allows user to adjust the counterbalance mechanism for easy movement of the monitor. Displays are able to tilt 180°, swing 180° side-to-side and rotate from landscape to portrait. Cable manager comes on extension arm and hides all cables. Minor assembly required.

Required Specifications

Finish (top)
Metal Finish (legs)

Optional Specifications

Anodized Aluminum Leg
High Pressure Laminate

ACCESSORIES

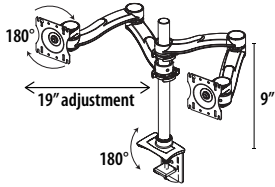

Dual Screen Double Extension Arm

MODEL#	DIMENSIONS D x W x H	FREIGHT CLASS	WT./LBS.	CUBIC FT.	LIST PRICE
GAMCDSDE	-- x -- x --	100	10.70	1.09	\$800

For dual monitor applications. Double extension arms allow 19" of horizontal back and forth movement. Easy to use Allen wrench allows user to adjust the counterbalance mechanism for easy movement of the monitor. Displays are able to tilt 180°, swing 180° side-to-side and rotate from landscape to portrait. Minor assembly required.

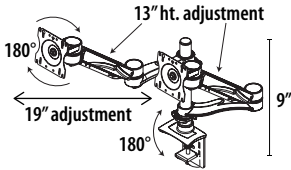

Dual Screen Double Extension Arm with Height Adjustment

GAMCDSDEH	-- x -- x --	92.5	12.2	1.09	\$883
-----------	--------------	------	------	------	--------------

For dual monitor applications. Counterbalanced arms provide an additional 13" of height adjustment. Double extension arms allow 19" of horizontal back and forth movement. Easy to use Allen wrench allows user to adjust the counterbalance mechanism for easy movement of the monitor. Displays are able to tilt 180°, swing 180° side-to-side and rotate from landscape to portrait. Cable manager comes on extension arm and hides all cables. Minor assembly required.

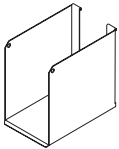

Binder Bin

BABB01	10.25 x 4 x 9	100	2	.21	\$53
--------	---------------	-----	---	-----	-------------

Load bar/accessory rail mounted metal binder bin.

- Please refer to the **Compatibility Guide** on pg. 386 to determine compatible storage components

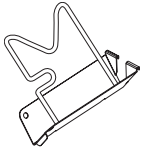

Flip Sorter

BAFS01	9.25 x 2.75 x 9.25	70	.06	.14	\$40
--------	--------------------	----	-----	-----	-------------

Load bar/accessory rail mounted metal flip sorter. Comes with chrome wire.

- Please refer to the **Compatibility Guide** on pg. 386 to determine compatible storage components

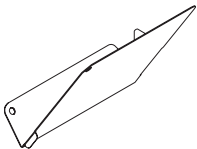

Slant Sorter

BASS01L (Left)	10.25 x 5 x 9.5	70	1	.28	\$33
BASS01R (Right)	10.25 x 5 x 9.5	70	1	.28	\$33

Load bar/accessory rail mounted metal slant sorter.

- Please refer to the **Compatibility Guide** on pg. 386 to determine compatible storage components

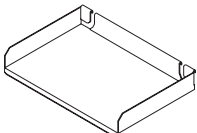

Letter/Legal Tray

BALTO1 (Letter)	9.25 x 13.5 x 2	70	.05	.15	\$43
BALTO1LGL (Legal)	9.25 x 15 x 2	70	.05	.15	\$54

Load bar/accessory rail mounted metal letter or legal tray.

- Please refer to the **Compatibility Guide** on pg. 386 to determine compatible storage components

Required Specifications

Fabric (Cushion)
Metal Finish (hanging bracket, whiteboard, tackboard)

ACCESSORIES

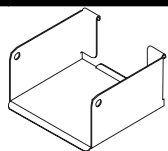
**Media Bin**

MODEL#	DIMENSIONS	FREIGHT CLASS	WT./LBS.	CUBIC FT.	LIST PRICE
	D x W x H				
BAMB01	5.25 x 5.75 x 3	70	.08	.05	\$43

Load bar/accessory rail mounted metal media bin.

- Please refer to the **Compatibility Guide** on pg. 386 to determine compatible storage components

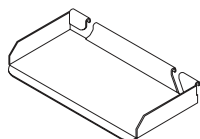
**Utility Tray**

BAUT01	3.75 x 5.75 x 3	70	.05	.02	\$28
--------	-----------------	----	-----	-----	-------------

Load bar/accessory rail mounted metal utility tray.

- Please refer to the **Compatibility Guide** on pg. 386 to determine compatible storage components

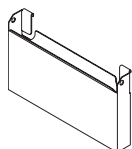
**Mail Box**

BAPP01	2.75 x 16 x 9	100	2	.25	\$68
--------	---------------	-----	---	-----	-------------

Load bar/accessory rail mounted metal mail box.

- Please refer to the **Compatibility Guide** on pg. 386 to determine compatible storage components

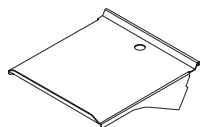
**Telephone Holder**

BATH01	10 x 9 x 2	125	2	.26	\$65
--------	------------	-----	---	-----	-------------

Load bar/accessory rail mounted metal telephone holder.

- Please refer to the **Compatibility Guide** on pg. 386 to determine compatible storage components

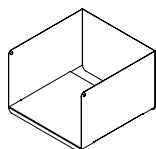
**Elevated Shelf Binder Bin**

BRTEBBIN	12 x 12 x 8	100	6	.66	\$142
----------	-------------	-----	---	-----	--------------

Load bar/accessory rail mounted elevated shelf binder bin.

- Please refer to the **Compatibility Guide** on pg. 386 to determine compatible storage components

ACCESSORIES

D x W x H

ACCESSORIES COMPATIBILITY GUIDE

	DIVIDERS: BRTL PDD BRTL PDS BR2AFD BR2AHD	Elevated Shelves BRTSTS08 BRTBTS08 8" high	Elevated Shelves BRTSTS13 BRTBTS13 13" high	Elevated Shelves BRTSTS16 BRTBTS16 16" high	Shared Overhead BRTBAS048 12" deep	Shared Overhead with slid- ing doors BRTBASS 16" deep
Binder Bin BABB01	yes	no	no	yes	no	no
Flip Sorter BAFS01	yes	no	yes	no	no	no
Slant Sorter BASS01	yes	no	yes	no	no	no
Letter Tray BALT01	yes	yes	yes	yes	yes	yes
Media Bin BAMB01	yes	yes	yes	yes	yes	yes
Utility Tray BAUT01	yes	yes	yes	yes	yes	yes
Mail Box BAPP01	yes	no	no	yes	no	no
Phone Holder BVATH01	yes	yes	yes	yes	yes	yes
Elevated Shelf Binder Bin BRTEBBIN	no	no	no	no	yes	no
Tackboard BRTTB	yes	no	no	yes	no	no
Whiteboard BRTWB	yes	no	no	yes	no	no

COLLABORATIVE SEATING**D x W x H**

Bridges collaborative seating collection consists of seating, privacy screens, tables, tablets and power. It is a versatile modular furniture series which can be configured into many space planning scenarios, including corner, in-line, open concept, traditional reception, as well as secluded seating with high privacy partitions.

Furniture pieces can be used as stand alone items or can be mechanically linked together to form a variety of seating configurations.

Seat and backrest can be integrated with Bridges tables.

Corner tables and in-line 6" table modules double as power delivery centers.

Dedicated seat backrests feature dual USB charging port.

Some inline 6" table modules are furnished with grommets to support tablets.

Legs are available in standard Bridges metal painted finishes and anodized aluminum finish.

Bridges Collaborative Seating upholstery features a single stitch, thick white thread around the edges. The white, wide stitch along with crisp corners are part of its distinctive personality. In order to achieve crisp edges and to minimize "pillow" effect caused by taut fabric, the upholstery material has been applied deliberately loose, which may over time, produce puckering of the upholstery surface material. This can be easily corrected by stretching the fabric by hand or during vacuuming.

In order to efficiently utilize fabric yield, all 60" seats and backs feature a seam in the middle. The double stitch seam is sewn with a thin thread, closely matching the upholstery material in color.

Some complicated fabric patterns prevent pattern matching and will be upholstered without the seam at the discretion of the factory.

Should you require no middle seam by cutting into the roll, please specify "NO SEAM" at time of your order.

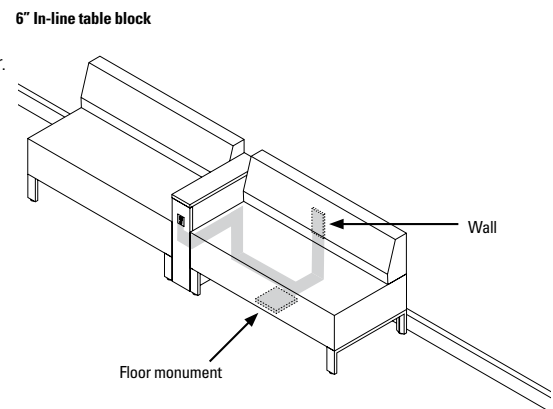
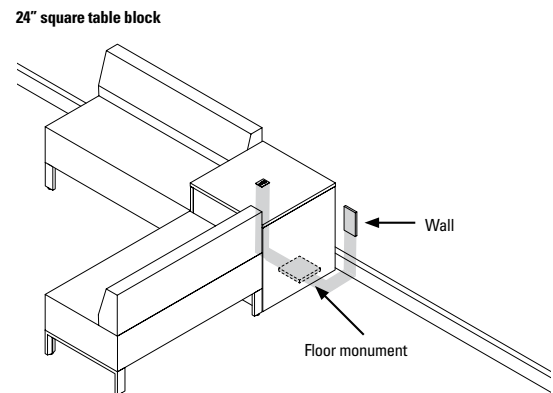
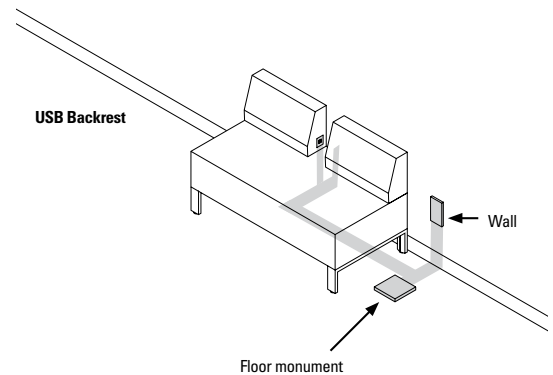

COLLABORATIVE SEATING

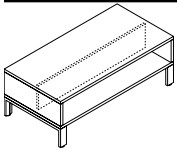

Low Table

MODEL#	DIMENSIONS D x W x H	FREIGHT CLASS	WT./LBS.	CUBIC FT.	LIST PRICE	HP ADD
BRTST2460F	24 x 60 x 17	150	83.60	14.17	\$699	\$257
BRTST2448F	24 x 48 x 17	125	69	11.33	\$625	\$185
BRTST2424F	24 x 24 x 17	125	40.70	5.67	\$441	\$75

Freestanding 17”h table. Central partition divides space under top surface into two 11” deep compartments. All LP chassis w/ HP or LP top (3mm edging). Bridges storage aluminum leg.

- Anodized Aluminum Leg - Add **\$52.** list upcharge
- To convert to mobile - Add an **M** at the end of the product code. Add **\$35.** list upcharge.

COLLABORATIVE SEATING

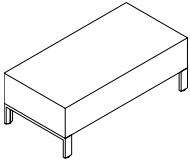

Lounge Seat

					GRADE	LIST	GRADE	LIST
BRTSE60NB	24 x 60 x 17	250	47	14.17	1	\$1319	7	\$1768
					2	\$1384	8	\$1924
					3	\$1435	9	\$2045
					4	\$1511	10	\$2179
					5	\$1619	11	\$2454
					6	\$1670	12	\$2748
BRTSE48NB	24 x 48 x 17	250	36.90	11.33	1	\$1140	7	\$1500
					2	\$1192	8	\$1625
					3	\$1233	9	\$1721
					4	\$1294	10	\$1828
					5	\$1380	11	\$2049
					6	\$1421	12	\$2284
BRTSE24NB	24 x 24 x 17	150	22.70	5.57	1	\$625	7	\$850
					2	\$658	8	\$928
					3	\$684	9	\$989
					4	\$722	10	\$1056
					5	\$776	11	\$1193
					6	\$801	12	\$1340

Fully upholstered armless lounge seat with metal base. Seats can be freestanding or linked with optional interlocking bracket kit.

- Anodized Aluminum Leg - Add **\$52.** list upcharge

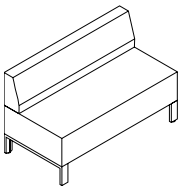

Lounge Seat, Full Backrest

BRTSE6060B	24 x 60 x 29	250	70	24.17	1	\$2109	7	\$2917
					2	\$2225	8	\$3198
					3	\$2317	9	\$3414
					4	\$2454	10	\$3655
					5	\$2648	11	\$4152
					6	\$2740	12	\$4681
BRTSE4848B	24 x 48 x 29	250	55.50	19.33	1	\$1819	7	\$2447
					2	\$1909	8	\$2666
					3	\$1981	9	\$2835
					4	\$2087	10	\$3022
					5	\$2239	11	\$3408
					6	\$2310	12	\$3819
BRTSE2424B	24 x 24 x 29	250	33	9.57	1	\$985	7	\$1389
					2	\$1044	8	\$1530
					3	\$1089	9	\$1638
					4	\$1158	10	\$1759
					5	\$1255	11	\$2007
					6	\$1301	12	\$2272

Fully upholstered armless lounge seat with full backrest and metal base. Backrests are permanently secured to the seats and cannot be reconfigured on site. Seats can be freestanding or linked with optional interlocking bracket kit.

- Anodized Aluminum Leg - Add **\$52.** list upcharge

Required Specifications

Fabric
Metal Finish (legs)

Optional Specifications

Anodized Aluminum Leg
High Pressure Laminate (low table)

COLLABORATIVE SEATING

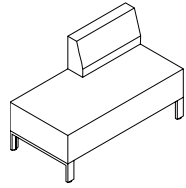

Lounge Seat, 24" Offset Backrest

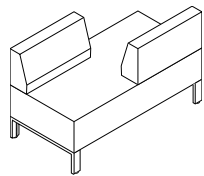

Lounge Seat, Two 24" Offset Backrests

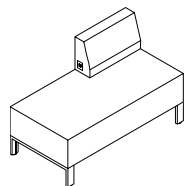

Lounge Seat, 21" USB Backrest

MODEL#	DIMENSIONS	FREIGHT CLASS	WT/LBS.	CUBIC FT.	GRADE	LIST	GRADE	LIST
D x W x H								
BRTSE2448BL	24 x 48 x 29	250	46.10	19.33	1	\$1500	7	\$2039
					2	\$1578	8	\$2226
					3	\$1639	9	\$2371
					4	\$1730	10	\$2531
					5	\$1860	11	\$2862
					6	\$1921	12	\$3215
BRTSE2448BR (shown)	24 x 48 x 29	250	46.10	19.33	1	\$1500	7	\$2039
					2	\$1578	8	\$2226
					3	\$1639	9	\$2371
					4	\$1730	10	\$2531
					5	\$1860	11	\$2862
					6	\$1921	12	\$3215
BRTSE2448BODL (shown)	24 x 48 x 29	250	46.10	19.33	1	\$1860	7	\$2578
					2	\$1963	8	\$2828
					3	\$2044	9	\$3020
					4	\$2166	10	\$3235
					5	\$2339	11	\$3676
					6	\$2421	12	\$4146
BRTSE2448BODR	24 x 48 x 29	250	46.10	19.33	1	\$1860	7	\$2578
					2	\$1963	8	\$2828
					3	\$2044	9	\$3020
					4	\$2166	10	\$3235
					5	\$2339	11	\$3676
					6	\$2421	12	\$4146
BRTSE2148EBL	24 x 48 x 29	250	33	9.67	1	\$1738	7	\$2277
					2	\$1816	8	\$2464
					3	\$1877	9	\$2609
					4	\$1968	10	\$2769
					5	\$2098	11	\$3100
					6	\$2159	12	\$3453
BRTSE2148EBR (shown)	24 x 48 x 29	250	46.10	19.33	1	\$1738	7	\$2277
					2	\$1816	8	\$2464
					3	\$1877	9	\$2609
					4	\$1968	10	\$2769
					5	\$2098	11	\$3100
					6	\$2159	12	\$3453

Fully upholstered armless lounge seat with one backrest and metal base. Specify backrest as either left or right side. Backrests are permanently secured to the bench and cannot be reconfigured on site. Seats can be freestanding or linked with optional interlocking bracket kit.

- Anodized Aluminum Leg - Add \$52. list upcharge

Fully upholstered armless lounge seat with two offset backrests and metal base. Specify either left or right backrest configuration. Backrests are permanently secured to the bench and cannot be reconfigured on site. Seats can be freestanding or linked with optional interlocking bracket kit.

- Anodized Aluminum Leg - Add \$52. list upcharge

Fully upholstered armless lounge seat with one backrest and metal base. 21" w backrest comes with embedded dual USB port in its side. Note: The side mounted power/USB outlets always point to the center of the seat. Each USB outlet offers 2 amps. AC/DC transformer plugs into the wall or floor monument (approx. 4' long cable available from the bottom of the seat). Transformer power consumption: 0.68 amps. Specify either left or right backrest configuration. Backrests are permanently secured to the bench and cannot be reconfigured on site. Seats can be freestanding or linked with optional interlocking bracket kit. White USB outlets.

- Anodized Aluminum Leg - Add \$52. list upcharge

Required Specifications

Fabric
Metal Finish (legs)

Optional Specifications

Anodized Aluminum Leg

COLLABORATIVE SEATING

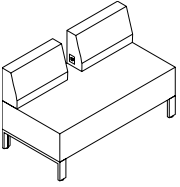

Lounge Seat, Two 21" USB Backrests

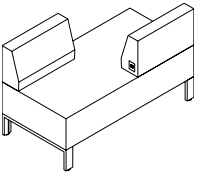

Lounge Seat, Two Offset USB Backrests

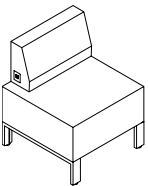

Lounge Seat, 21" USB Backrest

MODEL#	DIMENSIONS D x W x H	FREIGHT CLASS	WT/LBS.	CUBIC FT.	GRADE	LIST	GRADE	LIST
BRTSE2148E2B	24 x 48 x 29	250	57	19.33	1	\$2336	7	\$3054
					2	\$2439	8	\$3304
					3	\$2520	9	\$3496
					4	\$2642	10	\$3710
					5	\$2815	11	\$4151
					6	\$2897	12	\$4622

Fully upholstered armless lounge seat with two backrests and metal base. Both 21" w backrests come with embedded dual USB port in its side. Note: The side mounted power/USB outlets always point to the center of the seat. Each USB outlet offers 2 amps. AC/DC transformer plugs into the wall or floor monument (approx. 52" long cable available from the bottom of the seat). Transformer power consumption: 0.68 amps. Backrests are permanently secured to the bench and cannot be reconfigured on site. Seats can be freestanding or linked with optional interlocking bracket kit. White USB outlets.

- Anodized Aluminum Leg - Add \$52. list upcharge

BRTSE2148EBODL (shown)	24 x 48 x 29	250	57	19.33	1	\$2336	7	\$3054
					2	\$2439	8	\$3304
					3	\$2520	9	\$3496
					4	\$2642	10	\$3710
					5	\$2815	11	\$4151
					6	\$2897	12	\$4622

BRTSE2148EBODR	24 x 48 x 29	250	57	19.33	1	\$2336	7	\$3054
					2	\$2439	8	\$3304
					3	\$2520	9	\$3496
					4	\$2642	10	\$3710
					5	\$2815	11	\$4151
					6	\$2897	12	\$4622

Fully upholstered armless lounge seat with two offset backrests and metal base. Both 21" w backrests come with embedded dual USB port in its side. Note: The side mounted power/USB outlets always point to the center of the seat. Each USB outlet offers 2 amps. AC/DC transformer plugs into the wall or floor monument (approx. 52" long cable available from the bottom of the seat). Transformer power consumption: 0.68 amps. Specify either left or right backrest configuration. Backrests are permanently secured to the bench and cannot be reconfigured on site. Seats can be freestanding or linked with optional interlocking bracket kit. White USB outlets.

- Anodized Aluminum Leg - Add \$52. list upcharge

BRTSE2124EBL	24 x 24 x 29	250	46.10	19.33	1	\$1223	7	\$1628
					2	\$1282	8	\$1768
					3	\$1328	9	\$1876
					4	\$1396	10	\$1997
					5	\$1493	11	\$2245
					6	\$1539	12	\$2510

BRTSE2124EBR (shown)	24 x 24 x 29	250	46.10	19.33	1	\$1223	7	\$1628
					2	\$1282	8	\$1768
					3	\$1328	9	\$1876
					4	\$1396	10	\$1997
					5	\$1493	11	\$2245
					6	\$1539	12	\$2510

Fully upholstered armless lounge seat with one backrest and metal base. 21" w backrest comes with embedded dual USB port in its side. Note: Each USB outlet offers 2 amps. AC/DC transformer plugs into the wall or floor monument (approx. 52" long cable available from the bottom of the seat). Transformer power consumption: 0.68 amps. Specify either left or right. Backrests are permanently secured to the bench and cannot be reconfigured on site. Seats can be freestanding or linked with optional interlocking bracket kit. White USB outlets.

- Anodized Aluminum Leg - Add \$52. list upcharge

Required Specifications

Fabric
Metal Finish (legs)

Optional Specifications

Anodized Aluminum Leg

COLLABORATIVE SEATING

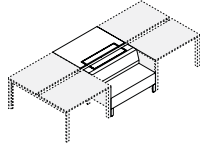

Integrated Lounge Seat, Single-Sided

MODEL#	DIMENSIONS	FREIGHT CLASS	WT/LBS.	CUBIC FT.	GRADE	LIST	GRADE	LIST		
BRTSINT60S	24 x 60 x 29	125	155	24.17						
					D x W x H					
					1	\$3349	7	\$4140		
					2	\$3449	8	\$4422		
					3	\$3540	9	\$4638		
					4	\$3678	10	\$4879		
5	\$3872	11	\$5375							
6	\$3964	12	\$5905							
BRTSINT48S	24 x 48 x 29	100	182	19.33	1	\$3170	7	\$3798		
					2	\$3261	8	\$4017		
					3	\$3332	9	\$4186		
					4	\$3439	10	\$4373		
					5	\$3590	11	\$4759		
					6	\$3661	12	\$5171		

Fully upholstered armless lounge seat with full width backrest and metal legs integrated into Bridges 62.5" d back-to-back linear table assembly. The single-sided kit consists of 24" x 48" or 24" x 60" seat, full width back, three-sided below worksurface enclosure, 6" d worksurface module with access door, 30" x 48" or 30" x 60" w worksurface with access door and supporting hardware. The seat module accommodates continuation of power and data distribution services below worksurfaces (specify Below Worksurface Power Trough and power components separately). The 6" d worksurface module with access door provides access to Below Worksurface Power Trough. Backrests are permanently secured to the bench and cannot be reconfigured on site. Tables not included.

• **Only compatible with back-to-back 30" d worksurfaces (62.5" total depth) supported by Bridges rectangular legs.** Not compatible with round legs, 24" d worksurfaces; not compatible with single line table assemblies 24" and 30" d. The kit cannot be used at the end of a table run, nor can it be used as a standalone, freestanding configuration. It must always be supported by back-to-back table assemblies on either side

- Anodized Aluminum Leg - Add **\$52** list upcharge
- High pressure laminate - Add **\$210** list upcharge

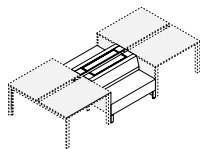

Integrated Lounge Seat, Double-Sided

BRTSINT60D	24 x 60 x 29	125	155	24.17	1	\$5477	7	\$6285
					2	\$5593	8	\$6566
					3	\$5685	9	\$6782
					4	\$5822	10	\$7023
					5	\$6016	11	\$7520
					6	\$6108	12	\$8049
BRTSINT48D	24 x 48 x 29	100	182	19.33	1	\$4898	7	\$5526
					2	\$4988	8	\$5745
					3	\$5060	9	\$5914
					4	\$5166	10	\$6101
					5	\$5318	11	\$6487
					6	\$5389	12	\$6898

Fully upholstered armless lounge bench with full backrests and metal legs integrated into Bridges 62.5" d back-to-back linear table assembly. The double-sided kit consists of two 24" x 48" or 24" x 60" seats, full width backs, three-sided below worksurface enclosures, 6" d worksurface modules with access doors and supporting hardware. The seat module accommodates continuation of power and data distribution services below worksurfaces (specify Below Worksurface Power Trough and power components separately). The 6" d worksurface module with access door provides access to Below Worksurface Power Trough. Backrests are permanently secured to the bench and cannot be reconfigured on site. Tables not included.

• **Only compatible with back-to-back 30" d worksurfaces (62.5" total depth) supported by Bridges rectangular legs.** Not compatible with round legs, 24" d worksurfaces; not compatible with single line table assemblies 24" and 30" d. The kit cannot be used at the end of a table run, nor can it be used as a standalone, freestanding configuration. It must always be supported by back-to-back table assemblies on either side.

- Anodized Aluminum Leg - Add **\$52** list upcharge
- High pressure laminate - Add **\$210** list upcharge

Required Specifications

Fabric
Laminate Finish (enclosure)
Metal Finish (legs)

Optional Specifications

Anodized Aluminum Leg
High Pressure Laminate (enclosure)

SEATING PARTITIONS

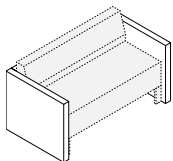

Seat Partitions

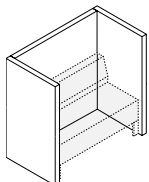

Seat Privacy Partitions

MODEL#	DIMENSIONS D x W x H	FREIGHT CLASS	WT/LBS.	CUBIC FT.	LIST PRICE
BRTPP2448L1	28.7 x 53 x 25	300	41	22.01	\$1545
BRTPP2424L1	28.7 x 29 x 25	250	32	12.04	\$1155

Fully upholstered 2.5" thick, 3-part, low level partition kit wraps around 24" or 48" bridges seat. The seat front is recessed by 2.5". The kit is secured to seats on-site (brackets connecting seat legs to the inner side of the partition are included). Upholstered kits consist of 2" hollow core boards, 1/4" foam, fabric, levelers and connecting hardware. Note: Seats and backrests are not included.

BRTPP2448L2	28.7 x 53 x 50	400	41	44.01	\$2240
BRTPP2424L2	28.7 x 29 x 50	300	32	24.08	\$1750

Fully upholstered 2.5" thick, 3-part, two tier partition kit wraps around 24" or 48" bridges seat. The 50"h assembly provides seated visual privacy. 2.5" thick upholstered partitions improve acoustic privacy for focused time away from the team or for a quiet phone call. Recessed seat extends the partition at the front by 2.5" for enhanced sense of privacy. The kit is secured to seats on-site (brackets connecting seat legs to the inner side of the partition are included). Upholstered kits consist of 2" hollow core boards, 1/4" foam, fabric, levelers and connecting hardware. Note: Seats and backrests are not included.

SEATING PARTITIONS

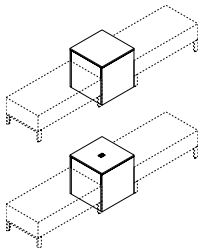

Square Table Block

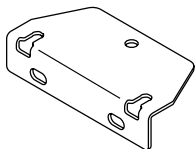

Square Table Block Ganging Bracket Kit

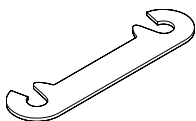

Ganging Bracket Kit

BRTS2424B	24 x 24 x 25	250	32	12.04	\$490	\$70
BRTS2424BP	24 x 24 x 25	125	59.30	8.33	\$980	\$70

Freestanding 24" square table block serves as a visual anchor whenever a bridges seat needs to turn a corner or split into 2, 3 or 4 directions. BRTS2424BP can be positioned directly over a floor monument, which will supply power to the top-mounted power module. This option includes 24"x 24" block chassis and flush-mounted Duo power module (two outlets and two 2.1 amp USB ports, white face plate, outlets and bezel, 72" long three prong black cord). The square table block can function as a self-supporting, freestanding unit or it can be secured permanently to adjacent bridges seats with optional interconnecting brackets listed below. 2 Square Table Ganging Bracket Kits included.

BRTSTBG	2.4 x 5 x 1.1	70	.05	.01	\$35	n/a
---------	---------------	----	-----	-----	-------------	-----

Two square table block ganging brackets connect seat legs permanently to the side of the 24" square table block on site. The kit employs machine screws connecting legs to seats, and ships with wood screws which provide permanent connection to the square table block. Includes 2 brackets and screws. Black powdercoat finish.

BRTSTSB	1.3 x 6 x .1	70	.03	.01	\$14	n/a
---------	--------------	----	-----	-----	-------------	-----

Two ganging brackets connect seat temporarily to adjacent in-line seat or 24"d bridges storage. Black powdercoat finish.

Required Specifications

Fabric

COLLABORATIVE SEATING

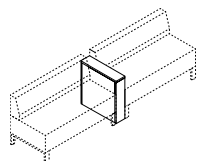
**Inline 6" Block**

BRTS2406B

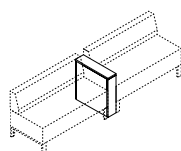

Inline table - no power module or swivel arm

MODEL#	DIMENSIONS	FREIGHT CLASS	WT/LBS.	CUBIC FT.	LIST PRICE	HP ADD
	D x W x H					
BRTS2406B	24 x 6 x 25	92.5	21	2.08	\$420	\$35
BRTS2406BP	24 x 6 x 25	92.5	23.30	2.08	\$910	\$35
BRTS2406B2P	24 x 6 x 25	92.5	24.30	2.08	\$1400	\$35
BRTS2406BT	24 x 6 x 25	85	25.60	2.08	\$805	\$35
BRTS2406BPT	24 x 6 x 25	92.5	24.30	2.08	\$1295	\$35

Multifunctional inline 6" table block divides seating areas, serves as a utility surface, can support tablet arms, lamps, and double as a power delivery center. It is permanently secured between two bridge seats and cannot be placed at the end of a run. Two Square Table Block Ganging Brackets (BRTSTBG) connect seat legs permanently to the side of the in-line table block on site. The included kit employs machine screws connecting legs to seats and ships with wood screws, which provide permanent connection to the in-line 6" block. Black powdercoat finish. The chassis is available without power module, with one power module or with two vertically embedded power modules. Vertical panel flush-mounted Duo module provides two outlets and two 2.1 amp USB ports; 72" cord exits through the bottom and plugs into a floor monument under seats, white face plate and bezel. 2 Square Table Ganging Bracket Kits included.

- BRTS2406BT and BRTS2406BPT include 9.5" x 14.5" swivel tablet. If top is specified in high pressure laminate, tablet will also be manufactured in high pressure laminate.

BRTS2406BP

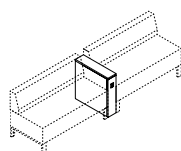

Inline table w/front power module

BRTS2406B2P

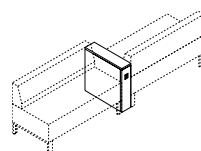

Inline table w/front and rear power module

BRTS2406BT

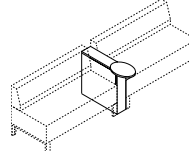

Inline table w/swivel tablet arm

BRTS2406BPT

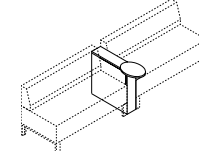

Inline table w/front power module and swivel tablet arm

Required Specifications

Finish (top)
Chassis/Accent Finish

Optional Specifications

High Pressure Laminate (top only)



Sidebar is well suited to the modern workplace. The wide range of options within the series allow for the product to be specified as a collaborative work environment in an open floor plan, or in private and semi-private settings all while keeping a similar, leg based aesthetic. Fun, unique and functional storage items provide personal touches to the workspace all while maintaining a practical appeal.

Varying levels of benching, dividers and storage heights create unique visual planes within the workspace, providing a break from the monotonous “cube farms” of the past. Multiple leg and foot styles are available and convey transitional or contemporary overtones, allowing the product to fit well within a variety of environments.



Features and Benefits

- All worksurfaces are 1” thick, constructed of 45 lb. density particle board covered on both sides with high performance thermally fused laminate.
- Worksurfaces available in four detail options.
- Tapered legs feature adjustable glides and can be painted in Black (BK) or Silver (SI).
- Tiered storage enhances the visuals of any office setting

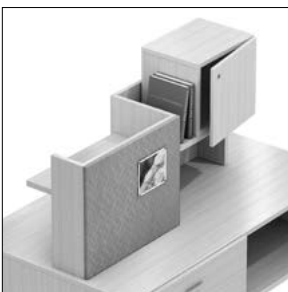

Shared storage



Wire pass-through



Low credenza storage with cushion

GENERAL INFORMATION

- SideBar features benching and desking components for use in open office, semi-private and private office settings.
- Melding the popular aesthetic of multiple series into a new series, SideBar is a great complement to Bungee & Bungee SL training tables as well as Zira Desking.
- Starter and add-on benching components are easy to specify and allow the end user a significant long term savings when reconfiguring products in the field.
- High pressure tops are available on all SideBar laminates at an extended lead time – please refer to model # for availability and pricing.
- Global laminate and seating products are in compliance with stringent emission guidelines set out by UL/Greenguard Environmental Institute under the standards for low emitting products and materials. www.greenguard.org
- **Level 3 Certified**

CONSTRUCTION

- Tops are 1” thick, available in a variety of edge details
- All finishes feature edging in matching color (i.e. wood grain surfaces feature edging with matching printed wood grain
- High pressure tops are available in all SideBar laminate finishes at an extended lead time. Please see model # for availability and pricing

DIVIDERS, FILLERS AND MODESTY PANELS

- 11/16” panels are finished with a matching edge
- Items feature pilot holes for attachment of hardware

STORAGE

- Tops of all storage units are 1” thick, available in a variety of edge details.
- Drawer and open cavity heights are built on a common module of 13.5”. In open cavities, this height accommodates standard size binders.
- All lateral files feature a foolproof interlock device.
- 75 lb. box – 150 lb. file drawer weight capacity with full height sides. Pencil try included in box drawer.
- All storage is standard with handles unless otherwise noted.
- All drawers are locking unless otherwise noted.
- All shelves are 3-position fixed/height adjustable

CONSTRUCTION

- Constructed of 45 lb. density particleboard covered on both sides with high performance thermally fused laminate
- Levelling glides are standard on all floor units
- Premium full extension progressive ball bearing slides on file drawers and box drawers
- All drawer fronts are edge banded on all four sides

LEGS AND FEET

- Leg assemblies feature two tapered legs welded to a steel cross beam. Levelers are standard; casters not available.
- Levelers adjust up to 1”.
- Storage unit feet will coordinate with handle finish (brass handles will default to Black [BK] feet).
- If no handle selection is available, legs and feet are available in Silver (SI) or Black (BK)

LOCKS

- Locks are standard on all storage modules unless otherwise noted. Lock finish will coordinate with handle finish (brass handles will default to Black [BK] locks).

SHIPPING

- Most items are shipped assembled, 1 per carton, unless otherwise noted. Items are easy to assemble

1. SPECIFY MODEL NUMBER

2. SPECIFY FINISH

Top/Base/Door, Drawer and Cabinet Finishes:

ACJ	Absolute Acajou	ASN	Asian Night
AWC	Avant Cherry	AWH	Avant Honey
BLK	Black	BRC	Brushed Cobalt
CSJ	Constellation Java	DES	Dark Espresso
HGT	Hayden Grey	QTM	Quartered Mahogany
SKC	Shaker Cherry	SOG	Storm Grey
TFW	Tiger Fruitwood	TMA	Tiger Mahogany
TMP	Tiger Maple	TWL	Tiger Walnut
WHT	White	WHC	White Chocolate*
WGY	Willow Grey	WCR	Winter Cherry

**textured*

Edge:

AB	Split color edge with Black Trim
AS	Split color edge with Silver Trim
A3	Standard edge
AR	Bicut edge

Legs:

Benching and Transition Desk Legs are available in Silver (SI) or Black (BK)

Feet:

Storage Feet are available in Silver (SI) or Black (BK)

3. SPECIFY OPTIONS

EDGE OPTIONS



A3 - square corner, standard edge



AR - square corner, bicut edge



AS - square corner, Silver



AB - square corner, Black

HANDLES

- Handles are standard on most drawers/storage modules. All other drawers, including mobile and hanging pedestals, can be ordered with a choice of nine handle options to be **factory installed**. Each handle is identified by the letters "HU", "HV", "HW", "HX", "HS", "HZ", "HO", "HQ", and "HR". To specify a handle, please specify the code after the model number. To order a handle as an option, please specify the code when ordering. List Price is **\$35**.



HS Flared Silver



HV Square Edge Silver



HO Crescent Black



HW Flared Brass



HU Square Edge Black



HZ Dimpled Nickel



HX Flared Black



HQ Bar Silver



HR Bar Black

GROMMETS

- Optional Grommets available in standard worksurface locations (left, center or right) on benching units, transitional work tables and pedestal returns. Order as: **AG1, AG2 or AG3 - Add \$65**
- Grommet hole dimensions are 3 1/4" wide x 1 7/8" deep.
- Grommets may be placed at non-standard locations. Order as: **AGS - Add \$65**. A drawing must be supplied with vertical and horizontal dimensions to the center of the cut-out (as in drawing above). Please refer to CUSTOM GROMMET LOCATION FORM in the back reference section.

Grommet hole dimensions

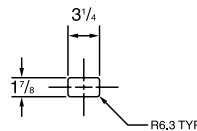

Grommet

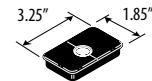

POWER BLOCK

- A Power block is a rectangular worksurface power/data module with one electrical duplex receptacle and two data (RJ45) receptacles. 9' black cord included. Power block dimensions are 3 1/2" deep x 6 1/2" wide x 2 3/4" high.
- Power block cutout dimensions are 2 3/4" deep x 6" wide.
- A Power block Cutout (model **PMSPDM**) are available in standard worksurface locations on benching units, transitional work tables and pedestal returns. Order as **E1, E2 or E3. Add \$65**.
- To purchase a Power block, you must specify both the Power block cut-out location and the Power block model #. Order Power block separately as **PMSPDM, ADD \$238**.

Power block:

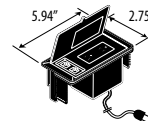

VILLA POWER BLOCK (CORDED VERSION ONLY)

- A Villa Power block (corded) is available in four options (see page 461 for Villa Corded details). Villa Power block (corded) dimensions vary by model. Villa cutout dimensions are 3" deep x 5 1/4" wide.
- Villa Power block Cutouts are available in standard worksurface locations on benching units, transitional work tables and pedestal returns. Order as: **V1, V2 or V3 - Add \$65 for each cutout**.
- To purchase a Villa Power block, you must specify both the Villa Power block cut-out location and the Villa Power block model #
- Order Villa Power block and Villa Grommet Cover separately, see page 461 for pricing and details.

Villa Power block:

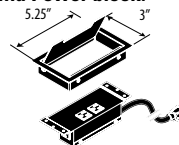

BENCHING UNITS

MODEL# DIMENSIONS FREIGHT CLASS WT/LBS. CUBIC FT. LIST PRICE HP ADD

D x W x H

S4248CER	48 x 42 x 29.6	92.5	98	8.47	\$880	\$325
S4848CER	48 x 48 x 29.6	92.5	109	9.22	\$945	\$371
S6048CER	48 x 60 x 29.6	85	131	10.48	\$1042	\$463
S7248CER	48 x 72 x 29.6	85	153	11.71	\$1158	\$556
S8448CER	48 x 84 x 29.6	85	175	12.96	\$1260	\$649

S4260CER	60 x 42 x 29.6	85	125	9.22	\$940	\$417
S4860CER	60 x 48 x 29.6	85	136	9.97	\$991	\$463
S6060CER	60 x 60 x 29.6	85	158	10.96	\$1125	\$579
S7260CER	60 x 72 x 29.6	150	180	37.43	\$1255	\$695
S8460CER	60 x 84 x 29.6	85	202	13.47	\$1366	\$811

Back-to-back end of run benching unit consists of two tops with a center cutaway for wire pass thru and one SideBar leg assembly on one side. Support bars extend 3.25" below worksurface (one for each surface) and are shipped together in a separate carton. Leg assembly is shipped in a separate carton. **Not freestanding.**

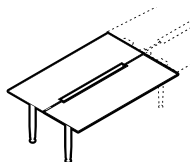

End of Run - 1 Leg

S4248BE	48 x 42 x 4.25	70	81	5	\$607	\$325
S4848BE	48 x 48 x 4.25	70	97	5.76	\$667	\$371
S6048BE	48 x 60 x 4.25	70	114	7	\$783	\$371
S7248BE	48 x 72 x 4.25	70	141	8.26	\$885	\$371
S8448BE	48 x 84 x 4.25	70	158	9.50	\$987	\$649

S4260BE	60 x 42 x 4.25	70	112	5	\$663	\$417
S4860BE	60 x 48 x 4.25	70	123	5.76	\$713	\$463
S6060BE	60 x 60 x 4.25	70	145	7	\$852	\$579
S7260BE	60 x 72 x 4.25	70	167	8.26	\$977	\$695
S8460BE	60 x 84 x 4.25	70	189	9.50	\$1088	\$811

Back-to-back middle benching unit consists of two tops with a center cutaway for wire pass thru. Support bars extend 3.25" below worksurface (one for each surface) and are shipped together in a separate carton. **Not freestanding.**

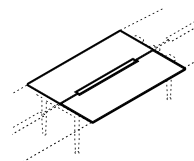

Middle - No Leg

S4248CS	48 x 42 x 29.6	85	114	8.47	\$1125	\$325
S4848CS	48 x 48 x 29.6	85	125	9.22	\$1186	\$371
S6048CS	48 x 60 x 29.6	85	147	10.48	\$1288	\$463
S7248CS	48 x 72 x 29.6	85	169	11.71	\$1403	\$556
S8448CS	48 x 84 x 29.6	85	191	12.96	\$1500	\$649

S4260CS	60 x 42 x 29.6	70	142	9.22	\$1181	\$417
S4860CS	60 x 48 x 29.6	70	153	9.97	\$1237	\$463
S6060CS	60 x 60 x 29.6	70	175	10.96	\$1371	\$579
S7260CS	60 x 72 x 29.6	70	197	12.46	\$1500	\$695
S8460CS	60 x 84 x 29.6	70	219	13.47	\$1607	\$811

Back-to-back standalone benching units consist of two tops with a center cutaway for wire pass thru and two SideBar leg assemblies for freestanding applications. Support bars extend 3.25" below worksurface (one for each surface) and are shipped together in a separate carton. Leg assemblies are shipped in a separate carton. Freestanding.

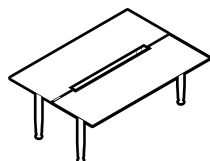

Standalone - 2 Legs

Required Specifications

Top finish
Top/edge detail
Base finish

Optional Specifications

HP laminate
Additional grommet
Power/data management troughs

Accessories

Power block

S SIDEBAR

STANDALONE STATIONS

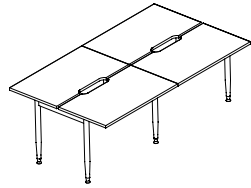

4 Pack

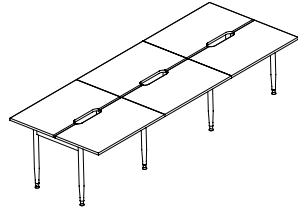

6 Pack

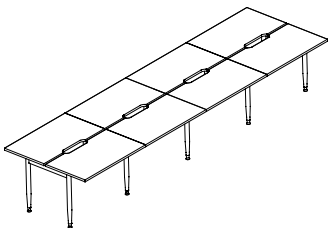

8 Pack

MODEL#	DIMENSIONS D x W x H	FREIGHT CLASS	WT./LBS.	CUBIC FT.	LIST PRICE	HP ADD
S4248CS4	48 x 84 x 29.6	250	198	90.30	\$2005	\$649
S4848CS4	48 x 96 x 29.6	150	454	96.41	\$2135	\$741
S6048CS4	48 x 120 x 29.6	150	542	108.6	\$2329	\$926
S7248CS4	48 x 144 x 29.6	150	630	120.9	\$2565	\$1112
S8448CS4	48 x 168 x 29.6	150	718	133.2	\$2769	\$1297
S4260CS4	60 x 84 x 29.6	150	520	98.98	\$2139	\$811
S4860CS4	60 x 96 x 29.6	150	564	105.0	\$2246	\$926
S6060CS4	60 x 120 x 29.6	150	652	117.3	\$2519	\$1158
S7260CS4	60 x 144 x 29.6	150	740	129.6	\$2769	\$1389
S8460CS4	60 x 168 x 29.6	150	828	141.9	\$2996	\$1621

Back-to-back standalone benching units consist of four tops with a center cutaway for wire pass thru and three SideBar leg assemblies for freestanding applications. Support bars extend 3.25" below worksurfaces (one for each surface) and are shipped together in a separate carton. Freestanding.

S4248CS6	48 x 126 x 29.6	300	303	160.7	\$2857	\$649
S4848CS6	48 x 144 x 29.6	300	336	173.6	\$3051	\$741
S6048CS6	48 x 180 x 29.6	250	402	199.4	\$3362	\$926
S7248CS6	48 x 216 x 29.6	250	468	225.2	\$3695	\$1112
S8448CS6	48 x 252 x 29.6	250	534	251.1	\$4005	\$1297
S4260CS6	60 x 126 x 29.6	250	385	172.8	\$3065	\$811
S4860CS6	60 x 144 x 29.6	250	418	185.8	\$3223	\$926
S6060CS6	60 x 180 x 29.6	250	484	211.6	\$3630	\$1158
S7260CS6	60 x 216 x 29.6	250	550	237.4	\$4010	\$1389
S8460CS6	60 x 252 x 29.6	250	616	263.2	\$4343	\$1621

Back-to-back standalone benching units consist of six tops with a center cutaway for wire pass thru and four SideBar leg assemblies for freestanding applications. Support bars extend 3.25" below worksurfaces (one for each surface) and are shipped together in a separate carton. Freestanding.

S4248CS8	48 x 168 x 29.6	300	410	307.8	\$3713	\$1297
S4848CS8	48 x 192 x 29.6	300	454	332.4	\$3968	\$1482
S6048CS8	48 x 240 x 29.6	300	542	379.1	\$4394	\$1852
S7248CS8	48 x 288 x 29.6	300	630	428.5	\$4825	\$2223
S8448CS8	48 x 336 x 29.6	300	718	475.2	\$5237	\$2593
S4260CS8	60 x 168 x 29.6	300	520	335.1	\$3987	\$1621
S4860CS8	60 x 192 x 29.6	300	564	357.1	\$4200	\$1852
S6060CS8	60 x 240 x 29.6	300	652	403.8	\$4741	\$2315
S7260CS8	60 x 288 x 29.6	300	740	453.3	\$5246	\$2778
S8460CS8	60 x 336 x 29.6	300	828	500	\$5695	\$3241

Back-to-back standalone benching units consist of eight tops with a center cutaway for wire pass thru and five SideBar leg assemblies for freestanding applications. Support bars extend 3.25" below worksurfaces (one for each surface) and are shipped together in a separate carton. Freestanding.

Required Specifications

Top finish
Top/edge detail
Base finish

Optional Specifications

HP laminate
Additional grommet
Power/data management troughs

Accessories

Power block

SINGLE SIDED STATIONS

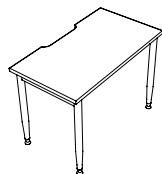

Single Sided Station

MODEL#	DIMENSIONS	FREIGHT CLASS	WT/LBS.	CUBIC FT.	LIST PRICE	HP ADD
D x W x H						
S4224SS1	24 x 42 x 29	250	53	22.16	\$903	\$163
S4824SS1	24 x 48 x 29	250	61	23.65	\$940	\$186
S6024SS1	24 x 60 x 29	250	71	26.95	\$1010	\$232
S7224SS1	24 x 72 x 29	250	82	29.94	\$1075	\$278
S8424SS1	24 x 84 x 29	250	92	32.93	\$1144	\$325
S4230SS1	30 x 42 x 29	250	67	22.46	\$954	\$204
S4830SS1	30 x 48 x 29	250	75	24.25	\$991	\$232
S6030SS1	30 x 60 x 29	250	86	27.69	\$1079	\$292
S7230SS1	30 x 72 x 29	250	99	30.69	\$1153	\$348
S8430SS1	30 x 84 x 29	250	110	33.68	\$1232	\$408

Single sided standalone benching units consist of one top with a center cutaway for wire pass thru and two SideBar leg assemblies for freestanding applications. A support bar extends 3.25" below worksurface and is shipped together in a separate carton. Freestanding.

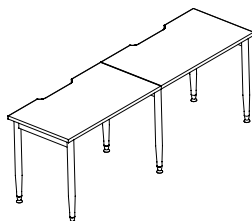

2 Single Sided Stations

S4224SS2	24 x 84 x 29	250	92	43.60	\$1551	\$325
S4824SS2	24 x 96 x 29	250	105	45.60	\$1630	\$371
S6024SS2	24 x 120 x 29	250	125	50	\$1764	\$463
S7224SS2	24 x 144 x 29	250	146	54	\$1899	\$556
S8424SS2	24 x 168 x 29	250	166	58	\$2033	\$649
S4230SS2	30 x 84 x 29	250	115	44	\$1649	\$408
S4830SS2	30 x 96 x 29	250	130	46.40	\$1723	\$463
S6030SS2	30 x 120 x 29	250	152	51	\$1899	\$579
S7230SS2	30 x 144 x 29	70	1075	55	\$2047	\$695
S8430SS2	30 x 168 x 29	250	198	59	\$2200	\$811

Single sided standalone benching units consist of two tops with a center cutaway for wire pass thru and three SideBar leg assemblies for freestanding applications. Support bars extend 3.25" below worksurfaces (one for each surface) and are shipped together in a separate carton. Freestanding.

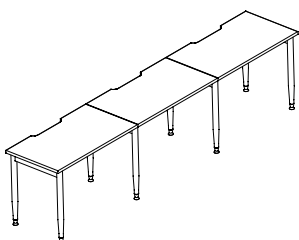

3 Single Sided Stations

S4224SS3	24 x 126 x 29	300	134	70	\$2200	\$487
S4824SS3	24 x 144 x 29	250	154	73.75	\$2320	\$556
S6024SS3	24 x 180 x 29	250	185	83.75	\$2524	\$695
S7224SS3	24 x 216 x 29	250	217	92.50	\$2723	\$834
S8424SS3	24 x 252 x 29	250	247	101.2	\$2926	\$973
S4230SS3	30 x 126 x 29	250	167	71.25	\$2343	\$612
S4830SS3	30 x 144 x 29	250	192	75	\$2454	\$695
S6030SS3	30 x 180 x 29	250	226	85	\$2718	\$871
S7230SS3	30 x 216 x 29	250	261	93.75	\$2940	\$1042
S8430SS3	30 x 252 x 29	250	295	102.5	\$3167	\$1218

Single sided standalone benching units consist of three tops with a center cutaway for wire pass thru and four SideBar leg assemblies for freestanding applications. Support bars extend 3.25" below worksurfaces (one for each surface) and are shipped together in a separate carton. Freestanding.

Required Specifications

Top finish
Top/edge detail
Base finish

Optional Specifications

HP laminate
Additional grommet
Power/data management troughs

Accessories

Power block

S SIDEBAR

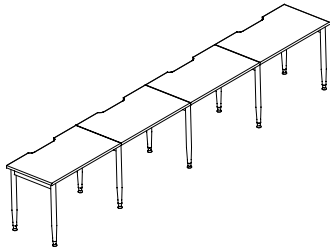

4 Single Sided Stations

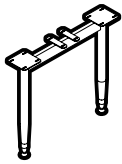

Legs

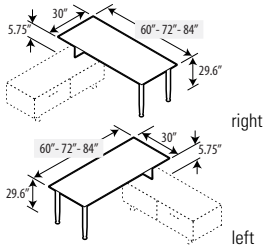

Transitional Work Tables

MODEL#	DIMENSIONS D x W x H	FREIGHT CLASS	WT/LBS.	CUBIC FT.	LIST PRICE	HP ADD
S4224SS4	24 x 168 x 29	300	172	109.2	\$2848	\$649
S4824SS4	24 x 192 x 29	300	198	116.7	\$3005	\$741
S6024SS4	24 x 240 x 29	300	239	128.7	\$3278	\$926
S7224SS4	24 x 288 x 29	300	281	140.7	\$3547	\$1112
S8424SS4	24 x 336 x 29	250	321	152.6	\$3815	\$1297
S4230SS4	30 x 168 x 29	300	217	110.7	\$3033	\$811
S4830SS4	30 x 192 x 29	250	247	118.2	\$3186	\$926
S6030SS4	30 x 240 x 29	250	292	130.2	\$3538	\$1158
S7230SS4	30 x 288 x 29	250	338	142.2	\$3829	\$1389
S8430SS4	30 x 336 x 29	250	383	155.6	\$4139	\$1621

Single sided standalone benching units consist of four tops with a center cutaway for wire pass thru and five SideBar leg assemblies for freestanding applications. Support bars extend 3.25" below worksurfaces (one for each surface) and are shipped together in a separate carton. Freestanding.

SXLEG48	6 x 26 x 28.6	150	18	3.60	\$246	n/a
SXLEG60	6 x 32 x 28.6	250	20	9	\$264	n/a

Leg assemblies for the structure of SideBar back-to-back tables. Used with SxxxxCER and SxxxxBE units to form extended runs of SideBar tables. Specify Black (BK) or Silver (SI). Tops sold separately.

- (1) SXLEG48 can be shared by four adjoining 24" d worksurfaces.
- (1) SXLEG60 can be shared by four adjoining 30" d worksurfaces.

S6030CLR	30 x 60 x 29.6	100	64	8	\$672	\$301
S7230CLR	30 x 72 x 29.6	100	74	9	\$737	\$348
S8430CLR	30 x 84 x 29.6	100	84	10	\$783	\$417
S6030CLL	30 x 60 x 29.6	100	64	8	\$672	\$301
S7230CLL	30 x 72 x 29.6	100	74	9	\$737	\$348
S8430CLL	30 x 84 x 29.6	100	84	10	\$783	\$417

Transitional table includes worksurface, SideBar leg assembly and laminate support base for use on **low credenzas**. Ships in two cartons.

Required Specifications

Top finish
Top/edge detail
Base finish

Optional Specifications

HP laminate
Additional grommet
Power/data management troughs

Accessories

Power block

TABLE DIVIDERS - LAMINATE

MODEL# DIMENSIONS FREIGHT CLASS WT/LBS. CUBIC FT. LIST PRICE HP ADD

D x W x H

S42FUL9	.69 x 42 x 6.75	70	16	.80	\$209	n/a
S48FUL9	.69 x 48 x 6.75	70	18	.90	\$227	n/a
S60FUL9	.69 x 60 x 6.75	70	21	1.10	\$250	n/a
S72FUL9	.69 x 72 x 6.75	70	23	1.20	\$269	n/a
S84FUL9	.69 x 84 x 6.75	70	26	1.40	\$292	n/a
S42FUL16	.69 x 42 x 13.5	70	19	1	\$250	n/a
S48FUL16	.69 x 48 x 13.5	70	22	1.20	\$269	n/a
S60FUL16	.69 x 60 x 13.5	70	27	1.40	\$288	n/a
S72FUL16	.69 x 72 x 13.5	70	32	1.60	\$311	n/a
S84FUL16	.69 x 84 x 13.5	70	37	1.80	\$329	n/a

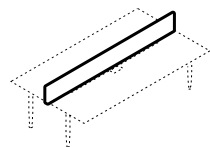

Full Width

Full width table dividers secure between **two back-to-back tables**, dividing space and providing varying levels of privacy. Specify the model # that corresponds to the overall surface width.

- SxxFUL9 dividers reach a finished height of 36.35", matching "Tier 2" units.
- SxxFUL16 dividers reach a finished height of 43.10", matching "Tier 2.5" units.

S42PAR9	.69 x 22 x 6.75	70	11	.50	\$176	n/a
S48PAR9	.69 x 28 x 6.75	70	12	.60	\$186	n/a
S60PAR9	.69 x 40 x 6.75	70	14	.80	\$204	n/a
S72PAR9	.69 x 52 x 6.75	100	16	2	\$227	n/a
S84PAR9	.69 x 64 x 6.75	70	19	1.10	\$246	n/a
S42PAR16	.69 x 22 x 13.5	70	14	.70	\$213	n/a
S48PAR16	.69 x 28 x 13.5	70	17	.80	\$227	n/a
S60PAR16	.69 x 40 x 13.5	70	22	1	\$246	n/a
S72PAR16	.69 x 52 x 13.5	70	26	1.20	\$264	n/a
S84PAR16	.69 x 64 x 13.5	70	14	.70	\$288	n/a

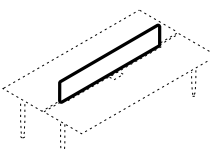

Partial Width

Partial width table dividers secure between **two back-to-back tables**, dividing space and providing varying levels of privacy. Partial width dividers are nominal and provide 10" of space on either side of the panel. Specify the model # that corresponds to the overall surface width.

- SxxPAR9 dividers reach a finished height of 36.35", matching "Tier 2" units.
- SxxPAR16 dividers reach a finished height of 43.10", matching "Tier 2.5" units.
- Gaps in between two adjacent panels can be filled with Separator Fillers and Shared Divider Storage Fillers. See page xx for details.

SS42FUL9	.69 x 42 x 25.75	85	29	2	\$329	n/a
SS48FUL9	.69 x 48 x 25.75	85	32	2.20	\$348	n/a
SS60FUL9	.69 x 60 x 25.75	85	36	2.80	\$389	n/a
SS72FUL9	.69 x 72 x 25.75	85	46	3.20	\$436	n/a
SS84FUL9	.69 x 84 x 25.75	85	53	3.80	\$473	n/a
SS42FUL16	.69 x 42 x 32.5	85	34	2.40	\$343	n/a
SS48FUL16	.69 x 48 x 32.5	85	38	2.60	\$380	n/a
SS60FUL16	.69 x 60 x 32.5	85	47	3.20	\$426	n/a
SS72FUL16	.69 x 72 x 32.5	85	55	3.80	\$477	n/a
SS84FUL16	.69 x 84 x 32.5	85	64	4.40	\$524	n/a

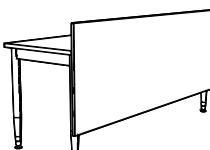

Full Width, for Single Sided Tables

Full width table dividers secure in front of **single sided tables**, dividing space and providing varying levels of privacy. Specify the model # that corresponds to the overall surface width.

- SSxxFUL9 dividers reach a finished height of 36.35", matching "Tier 2" units.
- SSxxFUL16 dividers reach a finished height of 43.10", matching "Tier 2.5" units.

Required Specifications

- Top finish
- Top/edge detail
- Base finish

Optional Specifications

- HP laminate
- Additional grommet
- Power/data management troughs

Accessories

- Power block

FILLERS

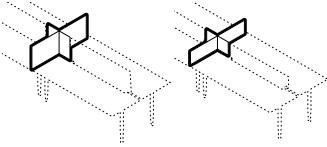

Middle Separating Filler

MODEL#	DIMENSIONS D x W x H	FREIGHT CLASS	WT./LBS.	CUBIC FT.	LIST PRICE	HP ADD
S2046S9	46 x 20 x 6.75	100	19	2.21	\$200	n/a
S2058S9	58 x 20 x 6.75	125	20	2.64	\$218	n/a
S2046S16	46 x 20 x 13.5	92.5	28	2.78	\$292	n/a
S2058S16	58 x 20 x 13.5	100	29	3.33	\$311	n/a

Middle separating fillers provide privacy and divide space between two users.

- To be used in conjunction with PARTIAL WIDTH table dividers
- SxxxxS9 dividers reach a finished height of 36.35", matching "Tier 2" units.
- SxxxxS16 dividers reach a finished height of 43.10", matching "Tier 2.5" units.

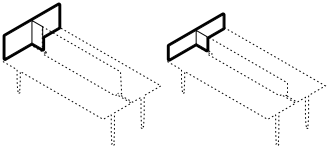

End Separating Filler

S1046E9	46 x 10 x 6.75	100	15	1.56	\$167	n/a
S1058E9	58 x 10 x 6.75	100	17	1.86	\$186	n/a
S1046E16	46 x 10 x 13.5	92.5	25	2.37	\$250	n/a
S1058E16	58 x 10 x 13.5	100	27	2.84	\$274	n/a

End separating fillers provide privacy at the end of a run of benching tables.

- To be used in conjunction with PARTIAL WIDTH table dividers
- SxxxxE9 dividers reach a finished height of 36.35", matching "Tier 2" units.
- SxxxxE16 dividers reach a finished height of 43.10", matching "Tier 2.5" units.

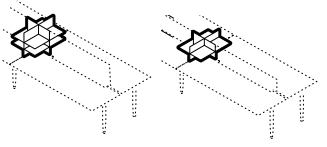

Middle Collator Filler

S2024C9	24 x 20 x 6.75	70	21	1.12	\$218	n/a
S2024C16	24 x 20 x 13.5	65	33	1.44	\$320	n/a

Middle collator fillers feature open storage between two users.

- To be used in conjunction with PARTIAL WIDTH table dividers
- SxxxxC9 dividers reach a finished height of 36.35", matching "Tier 2" units.
- SxxxxC16 dividers reach a finished height of 43.10", matching "Tier 2.5" units.

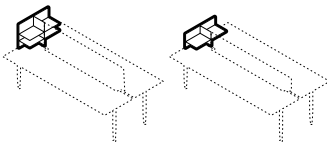

End Collator Filler

S1024EC9	24 x 10 x 6.75	70	14	.81	\$172	n/a
S1024EC16	24 x 10 x 13.5	70	22	1.30	\$241	n/a

End collator fillers feature open storage between two users.

- To be used in conjunction with PARTIAL WIDTH table dividers
- SxxxxEC9 dividers reach a finished height of 36.35", matching "Tier 2" units.
- SxxxxEC16 dividers reach a finished height of 43.10", matching "Tier 2.5" units.

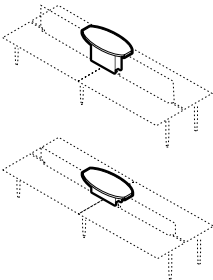

Transaction Top Filler

S3612T9	12 x 36 x 7.75	85	31	2.50	\$301	n/a
S3612T16	12 x 36 x 14.5	70	42	2	\$343	n/a

Transaction top filler feature an elevated worksurface between two users. Ships in two cartons.

- To be used in conjunction with PARTIAL WIDTH table dividers
- Product does not match any tier.
- S3612T9 dividers reach a finished height of 37.35".
- S3612T16 dividers reach a finished height of 44.10".

Required Specifications

Top finish
Top/edge detail (Transaction Shelf only)
Base finish

Optional Specifications

HP laminate (Transaction Top only)

FILLERS

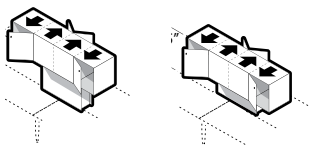

Shared Divider Storage Filler - Closed

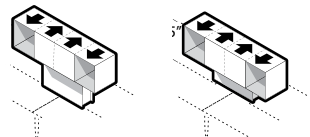

Shared Divider Storage Filler - Open

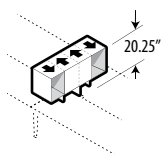

Shared Side Storage Filler - Open

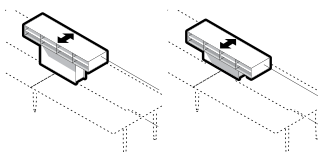

Shared Pigeon Hole Storage Filler

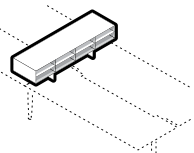

Shared Side Pigeon Hole Storage Filler

MODEL#	DIMENSIONS	FREIGHT CLASS	WT/LBS.	CUBIC FT.	LIST PRICE	HP ADD
D x W x H						
S4813PCL	13.4 x 48 x 20.25	85	110	8.98	\$1176	n/a
S4813PCH	13.4 x 48 x 27	85	120	9.46	\$1260	n/a
<p>Closed double sided storage units for users on opposite sides of back-to-back bench. Locking hinged doors. Openings will comfortably fit binders.</p> <ul style="list-style-type: none"> • To be used in conjunction with PARTIAL WIDTH table dividers • S4813PCL storage fillers reach a finished height of 49.85", matches Tier 3 when placed on benching units. • S4813PCH storage fillers reach a finished height of 56.6", matches Tier 3.5 when placed on benching units. 						
S4813POL	13.4 x 48 x 20.25	92.5	96	8.98	\$917	n/a
S4813POH	13.4 x 48 x 27	92.5	107	9.46	\$1005	n/a
<p>Open double sided storage units for users on opposite sides of back-to-back bench. Ships in three cartons. Openings will comfortably fit binders.</p> <ul style="list-style-type: none"> • To be used in conjunction with PARTIAL WIDTH table dividers • S4813POL storage fillers reach a finished height of 49.85", matches Tier 3 when placed on benching units. • S4813POH storage fillers reach a finished height of 56.6", matches Tier 3.5 when placed on benching units. 						
S3613SSO	13.4 x 36 x 20.25	92.5	67	5.75	\$612	n/a
S4813SSO	13.4 x 48 x 20.25	100	77	7.75	\$686	n/a
<p>Double sided storage units for users on both sides of a back-to-back bench. Openings will comfortably fit binders.</p> <ul style="list-style-type: none"> • To be used in conjunction with PARTIAL WIDTH table dividers • Sxx13SSO side storage fillers reach a finished height of 49.85", matches Tier 3 when placed on benching units. 						
S4212GL	12 x 42 x 11.65	85	37	2.70	\$760	n/a
S4212GH	12 x 42 x 18.35	70	66	4.40	\$843	n/a
<p>Pass thru pigeon hole storage for users on opposite sides of a back-to-back bench. Ships in three cartons.</p> <ul style="list-style-type: none"> • To be used in conjunction with PARTIAL WIDTH table dividers • Product does not match any tier. • S4212GL pigeon hole fillers reach a finished height of 41.25". • S4212GH pigeon hole fillers reach a finished height of 47.95". 						
S4212SG	12 x 42 x 6.75	85	37	2.70	\$510	n/a
<p>Pass thru pigeon hole storage for users on one side of a back-to-back bench.</p> <ul style="list-style-type: none"> • To be used in conjunction with PARTIAL WIDTH table dividers • S4212SG reaches a finished height of 36.35", matches Tier 2 when placed on benching units. 						

Required Specifications

Top finish
 Top/edge detail
 Base finish

Door Fronts (Shared Divider Storage only)
 Collator Finish (Pigeon Hole Storage only)
 Lock Finish (Shared Divider w/Doors only)

RETURNS

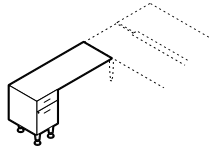

Pedestal Return - Left

MODEL#	DIMENSIONS D x W x H	FREIGHT CLASS	WT/LBS.	CUBIC FT.	LIST PRICE	HP ADD
S3620CZL	20 x 36 x 29.6	100	99	10.10	\$889	\$116
S4220CZL	20 x 42 x 29.6	100	103	10.50	\$908	\$139
S4820CZL	20 x 48 x 29.6	100	106	10.76	\$926	\$163
S5420CZL	20 x 54 x 29.6	100	110	11.10	\$940	\$186
S3624CZL	24 x 36 x 29.6	100	112	12	\$945	\$139
S4224CZL	24 x 42 x 29.6	100	116	12.26	\$968	\$163
S4824CZL	24 x 48 x 29.6	100	120	12.76	\$987	\$186
S5424CZL	24 x 54 x 29.6	100	124	13	\$1005	\$209

Flush return with 16" w box/file pedestal on **LEFT** with handles. Lock secures both drawers. Ships in two cartons.

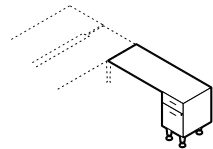

Pedestal Return - Right

S3620CZR	20 x 36 x 29.6	100	99	10.10	\$889	\$116
S4220CZR	20 x 42 x 29.6	100	103	10.50	\$908	\$139
S4820CZR	20 x 48 x 29.6	100	106	10.76	\$926	\$163
S5420CZR	20 x 54 x 29.6	100	110	11.10	\$940	\$186
S3624CZR	24 x 36 x 29.6	100	112	12	\$945	\$139
S4224CZR	24 x 42 x 29.6	100	116	12.26	\$968	\$163
S4824CZR	24 x 48 x 29.6	100	120	12.76	\$987	\$186
S5424CZR	24 x 54 x 29.6	100	124	13	\$1005	\$209

Flush return with 16" w box/file pedestal on **RIGHT** with handles. Lock secures both drawers. Ships in two cartons.

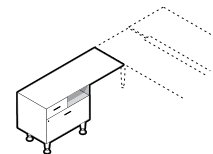

Mixed Storage Return - Left

S4220CPL	20 x 42 x 29.6	100	140	16.40	\$1167	n/a
S4820CPL	20 x 48 x 29.6	100	144	16.76	\$1186	n/a
S5420CPL	20 x 54 x 29.6	100	148	17	\$1204	n/a
S6020CPL	20 x 60 x 29.6	100	151	17.30	\$1218	n/a
S4224CPL	24 x 42 x 29.6	100	158	19.26	\$1237	n/a
S4824CPL	24 x 48 x 29.6	100	162	19.60	\$1260	n/a
S5424CPL	24 x 54 x 29.6	100	166	20	\$1278	n/a
S6024CPL	24 x 60 x 29.6	100	170	20.40	\$1297	n/a

Flush return with 30" w mixed storage pedestal on **LEFT** with handles. Box drawer upper left, open shelf upper right and lateral file on bottom. Lock secures both drawers. Ships in two cartons.

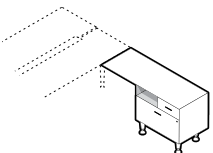

Mixed Storage Return - Right

S4220CPR	20 x 42 x 29.6	100	140	16.40	\$1167	n/a
S4820CPR	20 x 48 x 29.6	100	144	16.76	\$1186	n/a
S5420CPR	20 x 54 x 29.6	100	148	17	\$1204	n/a
S6020CPR	20 x 60 x 29.6	100	151	17.30	\$1218	n/a
S4224CPR	24 x 42 x 29.6	100	158	19.26	\$1237	n/a
S4824CPR	24 x 48 x 29.6	100	162	19.60	\$1260	n/a
S5424CPR	24 x 54 x 29.6	100	166	20	\$1278	n/a
S6024CPR	24 x 60 x 29.6	100	170	20.40	\$1297	n/a

Flush return with 30" w mixed storage pedestal on **RIGHT** with handles. Box drawer upper right, open shelf upper left and lateral file on bottom. Lock secures both drawers. Ships in two cartons.

Required Specifications

Top finish
Top/edge detail
Base finish
Handles, Drawer Fronts

Optional Specifications

HP laminate
Power block cut out grommet

Accessories

Power block

MODESTIES AND DIVIDERS

MODEL# DIMENSIONS FREIGHT CLASS WT/LBS. CUBIC FT. LIST PRICE HP ADD

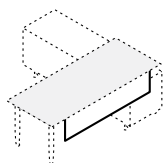

Modesty for Transitional Work Table

	D x W x H					
S60MPTC	.69 x 44 x 14	60	32	.80	\$167	n/a
S72MPTC	.69 x 56 x 14	60	38	1	\$190	n/a
S84MPTC	.69 x 68 x 14	60	45	1.10	\$204	n/a

Modesty attaches to Transitional Work Table. Modesty is inset .6875" (11/16") from the front edge and 8.25" from each side. Modesty clearance is 14.5" above finished floor. Specify the model # that corresponds to the overall surface width. Ships in two cartons.

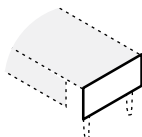

Flush End of Run Modesty Panel for Transitional Tables

S30SMP1	.69 x 30 x 21.25	70	13	.60	\$204	n/a
---------	------------------	----	----	-----	--------------	-----

Flush end of run modesty matches the height of the worksurface. End cap clearance is 8.25" above finished floor. Ships in two cartons.

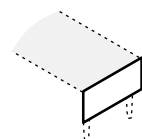

Flush End of Run Modesty Panel for Single Sided Benching Units

SS24SMP1	.69 x 24 x 21.25	70	21	1	\$149	n/a
SS30SMP1	.69 x 30 x 21.25	65	28	1.20	\$181	n/a

Flush end of run modesty matches the height of the worksurface. End cap clearance is 8.25" above finished floor. Ships in two cartons.

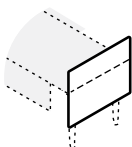

Partial Height End of Run Divider for Transitional Tables

S30SMP3	.69 x 30 x 25.75	70	19	.90	\$204	n/a
---------	------------------	----	----	-----	--------------	-----

Partial height end of run divider runs above and below the worksurface. Top of the panel is 6.75" above the worksurface. Clearance is 8.25" above finished floor. Ships in two cartons.

- S30SMP3 work table dividers reach a finished height of 36.35", matches Tier 2 when placed on work tables.

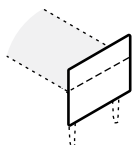

Partial Height End of Run Divider for Single Sided Benching Units

SS24SMP3	.69 x 24 x 25.75	70	25	1.20	\$186	n/a
SS30SMP3	.69 x 30 x 25.75	65	32	1.40	\$204	n/a

Partial height end of run divider runs above and below the worksurface. Top of the panel is 6.75" above the worksurface. Clearance is 8.25" above finished floor. Ships in two cartons.

- SS30SMP3 work table dividers reach a finished height of 36.35", matches Tier 2 when placed on work tables.

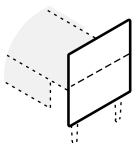

Full Height End of Run Divider for Transitional Tables

S30SMP2	.69 x 30 x 34.75	70	23	1.08	\$227	n/a
---------	------------------	----	----	------	--------------	-----

Full height end of run divider runs above and below the worksurface. Top of the panel is 13.5" above the worksurface. End cap clearance is 8.25" above finished floor. Ships in two cartons.

- S30SMP2 end of run dividers reach a finished height of 43.10", matches Tier 2.5 when placed on work tables.

Required Specifications

Modesty Panel / Divider Finish

MODESTIES AND DIVIDERS

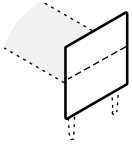

Full Height End of Run Divider for Single Sided Benching Units

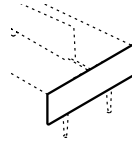

Flush End of Run Modesty

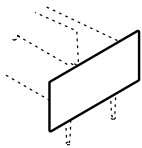

Partial Height End of Run Divider

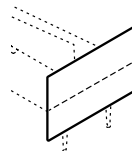

Full Height End of Run Divider

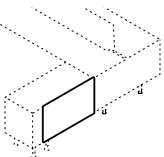

Flush Modesty for Returns

MODEL#	DIMENSIONS	FREIGHT CLASS	WT/LBS.	CUBIC FT.	LIST PRICE	HP ADD
--------	------------	---------------	---------	-----------	------------	--------

D x W x H

SS24SMP2	.69 x 24 x 32.5	70	28	1.40	\$172	n/a
SS30SMP2	.69 x 30 x 32.5	70	36	1.70	\$223	n/a

Full height end of run divider runs above and below the worksurface. Top of the panel is 13.5" above the worksurface. End cap clearance is 8.25" above finished floor. Ships in two cartons.

- SS30SMP2 end of run dividers reach a finished height of 43.10", matches Tier 2.5 when placed on work tables.

S48MPB1	.69 x 48 x 21.25	60	32	.90	\$190	n/a
S60MPB1	.69 x 60 x 21.25	60	42	1.10	\$195	n/a

Flush end of run modesty matches the height of the worksurface. End cap clearance is 8.25" above finished floor. Ships in two cartons.

- S48MPB1 to be used with 24"d back-to-back benching units.
- S60MPB1 to be used with 30"d back-to-back benching units.

S48MPB2	.69 x 48 x 25.75	60	37	1.16	\$232	n/a
S60MPB2	.69 x 60 x 25.75	60	47	1.40	\$237	n/a

Partial height end of run divider runs above and below the worksurface. Top of the panel is 6.75" above the worksurface. Clearance is 8.25" above finished floor. Ships in two cartons.

- S48MPB2 to be used with 24"d back-to-back benching units.
- S60MPB2 to be used with 30"d back-to-back benching units.
- SxxMPB2 end of run dividers reach a finished height of 36.35", matches Tier 2 when placed on benching units.

S48MPB5	.69 x 48 x 32.5	70	33	1.56	\$223	n/a
S60MPB5	.69 x 60 x 32.5	65	43	1.90	\$250	n/a

Full height end of run divider runs above and below the worksurface. Top of the panel is 13.5" above the worksurface. Clearance is 8.25" above finished floor. Ships in two cartons.

- S48MPB5 to be used with 24"d back-to-back benching units.
- S60MPB5 to be used with 30"d back-to-back benching units.
- SxxMPB5 end of run dividers reach a finished height of 43.10", matches Tier 2.5 when placed on benching units.

S36MPR1	.69 x 28.5 x 21.25	60	20	.60	\$176	n/a
S42MPR1	.69 x 34.5 x 21.25	60	21	.70	\$190	n/a
S48MPR1	.69 x 40.5 x 21.25	65	23	.80	\$204	n/a
S54MPR1	.69 x 46.5 x 21.25	65	24	.90	\$218	n/a
S60MPR1	.69 x 52.5 x 21.25	65	25	.90	\$232	n/a

Flush modesty panel for use on returns. Top of the modesty panel matches the height of the worksurface. Modesty panel is inset 7.5" from the pedestal end of the return. Modesty panel clearance is 8.5" above finished floor. Specify the model # that corresponds to the overall return width. Ships in two cartons.

Required Specifications

Modesty panel / divider finish

MODESTIES AND DIVIDERS

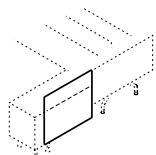

Partial Height Divider for Returns

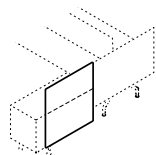

Full Height Divider for Returns

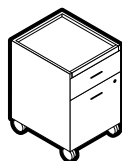

Mobile Pedestal

MODEL#	DIMENSIONS D x W x H	FREIGHT CLASS	WT/LBS.	CUBIC FT.	LIST PRICE	HP ADD
S36MPR5	.69 x 28.5 x 25.75	65	18	.76	\$167	n/a
S42MPR5	.69 x 34.5 x 25.75	65	21	.86	\$176	n/a
S48MPR5	.69 x 40.5 x 25.75	65	24	1.06	\$190	n/a
S54MPR5	.69 x 46.5 x 25.75	70	27	1.26	\$204	n/a
S60MPR5	.69 x 52.5 x 25.75	65	30	1.26	\$218	n/a

Partial height divider for use on returns. Modesty panel is inset 7.5" from the pedestal end of the return. Modesty panel clearance is 8.25" above finished floor. Specify the model # that corresponds to the overall return width. Ships in two cartons.

- SxxMPR5 pedestal return dividers reach a finished height of 36.35", matches Tier 2 when placed on returns.

S36MPR4	.69 x 28.5 x 32.5	70	22	1	\$190	n/a
S42MPR4	.69 x 34.5 x 32.5	70	25	1.16	\$204	n/a
S48MPR4	.69 x 40.5 x 32.5	70	28	1.32	\$218	n/a
S54MPR4	.69 x 46.5 x 32.5	70	31	1.48	\$232	n/a
S60MPR4	.69 x 52.5 x 32.5	70	34	1.66	\$246	n/a

Full height divider for use on returns. Modesty panel is inset 7.5" from the pedestal end of the return. Modesty panel clearance is 8.25" above finished floor. Specify the model # that corresponds to the overall return width. Ships in two cartons.

- SxxMPR4 end of run dividers reach a finished height of 43.10", matches Tier 2.5 when placed on returns.

S1619MP	19 x 16 x 25	85	76	6	\$700	n/a
S1623MP	23 x 16 x 25	92.5	82	7	\$727	n/a

Box/File drawers on fully progressive ball bearing slides, accommodate letter and legal size hanging files. Pedestal top is inset within side panels. Includes counterweight to prevent tipping. Drawers are locking. Handles are standard. Only front casters are locking.

- File drawer construction is for accommodating hanging files and NOT for stacking material on the drawer bottom.

Required Specifications

- Top finish / modesty + divider finish
- Drawer front finish (Mobile Pedestal only)
- Base finish (Mobile Pedestal only)
- Handles (Mobile Pedestal only)

STORAGE

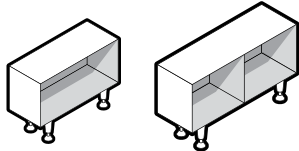

30" w

36" w

Low Bookcase

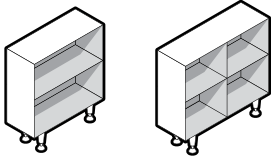

30" w

36" w

2 High Bookcase

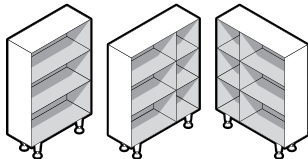

30" w

36" w - left

36" w - right

3 High Bookcase

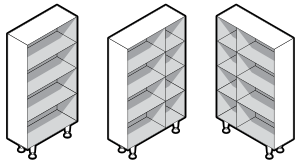

30" w

36" w - left

36" w - right

4 High Bookcase

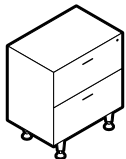

2 High Lateral File

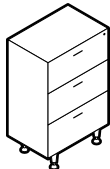

3 High Lateral File

MODEL#	DIMENSIONS	FREIGHT CLASS	WT/LBS.	CUBIC FT.	LIST PRICE	HP ADD
--------	------------	---------------	---------	-----------	------------	--------

D x W x H

S3012A0	12 x 30 x 22.85	125	49	7	\$436	n/a
S3612A0	12 x 36 x 22.85	125	61	8.25	\$505	n/a

Open bookcases accommodate binders in every cavity. One fixed shelf. 36" w units feature a fixed vertical divider.

S3012D0	12 x 30 x 36.35	125	77	10.50	\$602	n/a
S3612D0	12 x 36 x 36.35	125	94	12.50	\$700	n/a

Open bookcases accommodate binders in every cavity. One 3-position fixed/height adjustable shelf and one fixed shelf. 36" w units feature a fixed vertical divider. Matches Tier 2.

S3012F0	12 x 30 x 49.85	125	102	14	\$727	n/a
S3612FOL	12 x 36 x 49.85	125	127	16.50	\$862	n/a
S3612FOR	12 x 36 x 49.85	125	127	16.50	\$862	n/a

Open bookcases accommodate binders in every cavity. Two 3-position fixed/height adjustable shelves and one fixed shelf. 36" w units feature a fixed vertical divider. Matches Tier 3.

S3012H0	12 x 30 x 63.35	125	129	17.50	\$862	n/a
S3612HOL	12 x 36 x 63.35	125	161	20.75	\$1038	n/a
S3612HOR	12 x 36 x 63.35	125	161	20.75	\$1038	n/a

Open bookcases accommodate binders in every cavity. Three 3-position fixed/height adjustable shelves and one fixed shelf. 36" w units feature a fixed vertical divider. Matches Tier 4.

S3020DZ	20 x 30 x 36.35	100	142	16.50	\$1181	n/a
S3024DZ	24 x 30 x 36.35	125	149	19.50	\$1246	n/a
S3620DZ	20 x 36 x 36.35	125	153	19.50	\$1278	n/a
S3624DZ	24 x 36 x 36.35	125	168	23.35	\$1348	n/a

Two file drawers. Handles are standard. Lock secures all drawers. Front-to-back and side-to-side letter/legal filing capability. Matches Tier 2.

- Lateral file drawer construction is for accommodating hanging files and NOT for stacking material on the drawer bottom.

S3020FZ	20 x 30 x 49.85	100	191	22	\$1454	n/a
S3024FZ	24 x 30 x 49.85	125	198	26	\$1528	n/a
S3620FZ	20 x 36 x 49.85	125	203	26	\$1575	n/a
S3624FZ	24 x 36 x 49.85	125	221	31	\$1658	n/a

Three file drawers. Handles are standard. Lock secures all drawers. Front-to-back and side-to-side letter/legal filing capability. Matches Tier 3.

- Lateral file drawer construction is for accommodating hanging files and NOT for stacking material on the drawer bottom.

Required Specifications

Top finish
Top/edge detail
Base finish
Drawer Front Finish (Units w/doors)

Handles
Leg Finish (Bookcases only)
Shelf Finish (Open Units)

STORAGE

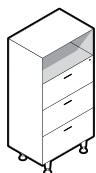

3 High Lateral File - Open

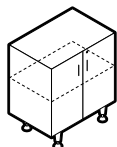

2 High Storage Cabinet

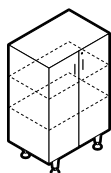

3 High Storage Cabinet

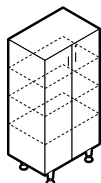

4 High Storage Cabinet

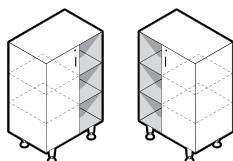

left right

3 High Mixed Storage Cabinet

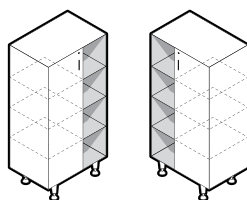

left right

4 High Mixed Storage Cabinet

MODEL#	DIMENSIONS D x W x H	FREIGHT CLASS	WT/LBS.	CUBIC FT.	LIST PRICE	HP ADD
S3020HZ	20 x 30 x 63.35	100	239	27.50	\$1788	n/a
S3024HZ	24 x 30 x 63.35	125	246	32.50	\$1875	n/a
S3620HZ	20 x 36 x 63.35	125	253	32.75	\$1936	n/a
S3624HZ	24 x 36 x 63.35	125	275	38.75	\$2033	n/a

Three file drawers. Handles are standard. Lock secures all drawers. Front-to-back and side-to-side letter/legal filing capability. Matches Tier 4.

- Lateral file drawer construction is for accommodating hanging files and NOT for stacking material on the drawer bottom.

S3020DX	20 x 30 x 36.35	125	122	16.50	\$917	n/a
S3024DX	24 x 30 x 36.35	125	139	19.50	\$987	n/a
S3620DX	20 x 36 x 36.35	125	151	19.50	\$1075	n/a
S3624DX	24 x 36 x 36.35	125	173	23	\$1172	n/a

Laminate doors are standard. Handles are standard. One 3-position fixed/height adjustable shelf and one fixed shelf. Standard with lock. Matches Tier 2.

S3020FX	20 x 30 x 49.85	125	167	22	\$1135	n/a
S3024FX	24 x 30 x 49.85	125	190	26	\$1227	n/a
S3620FX	20 x 36 x 49.85	100	209	23.75	\$1348	n/a
S3624FX	24 x 36 x 49.85	125	238	30.75	\$1473	n/a

Laminate doors are standard. Handles are standard. Includes two 3-position fixed/height adjustable shelves and one fixed shelf. Standard with lock. Matches Tier 3.

S3020HX	20 x 30 x 63.35	125	212	27.50	\$1362	n/a
S3024HX	24 x 30 x 63.35	125	241	32.50	\$1477	n/a
S3620HX	20 x 36 x 63.35	100	266	32.50	\$1658	n/a
S3624HX	24 x 36 x 63.35	125	303	38.50	\$1806	n/a

Laminate doors are standard. Handles are standard. Includes three 3-position fixed/height adjustable shelves and one fixed shelf. Standard with lock. Matches Tier 4.

S3020FXL	20 x 30 x 49.85	100	178	22	\$1144	n/a
S3024FXL	24 x 30 x 49.85	125	205	26	\$1255	n/a
S3020FXR	20 x 30 x 49.85	100	178	22	\$1144	n/a
S3024FXR	24 x 30 x 49.85	125	205	26	\$1255	n/a

Laminate door is standard. Handles are standard. Includes two 3-position fixed/height adjustable shelves and one fixed shelf. Specify left or right. Standard with lock. Matches Tier 3.

S3020HXL	20 x 30 x 63.35	100	226	27.50	\$1380	n/a
S3024HXL	24 x 30 x 63.35	100	261	32.50	\$1510	n/a
S3020HXR	20 x 30 x 63.35	100	226	27.50	\$1380	n/a
S3024HXR	24 x 30 x 63.35	100	261	32.50	\$1510	n/a

Laminate door is standard. Handles are standard. Includes three 3-position fixed/height adjustable shelves and one fixed shelf. Specify left or right. Standard with lock. Matches Tier 3.

Required Specifications

Top finish	Handles
Top/edge detail	
Base finish	
Door / Drawer Front Finish	

STORAGE

MODEL# DIMENSIONS FREIGHT CLASS WT/LBS. CUBIC FT. LIST PRICE HP ADD

D x W x H

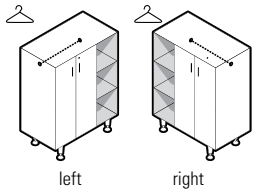

Wardrobe - Laminate Doors

S3620FWL	20 x 36 x 49.85	125	178	26	\$1200	n/a
S3624FWL	24 x 36 x 49.85	125	203	30.75	\$1297	n/a
S3620FWR	20 x 36 x 49.85	125	178	26	\$1200	n/a
S3624FWR	24 x 36 x 49.85	125	203	30.75	\$1297	n/a

Laminate doors are standard. Handles are standard. Full length hanging rod included. Includes two 3-position fixed/height adjustable shelves and one fixed shelf. Specify left or right. Standard with lock. Matches Tier 3.

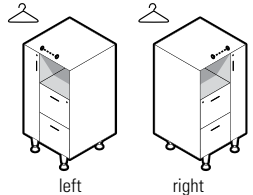

Wardrobe Tower - File/File

S2424FWL	24 x 24 x 49.85	100	189	21	\$1468	n/a
S2430FWL	30 x 24 x 49.85	100	221	26	\$1519	n/a
S2424FWR	24 x 24 x 49.85	100	189	21	\$1468	n/a
S2430FWR	30 x 24 x 49.85	100	221	26	\$1519	n/a

File/file drawers, open compartment, wardrobe cabinet with hanging rod, left or right handed. Handles are standard. Lock secures all drawers. Front-to-back and side-to-side letter/legal filing capability. Matches Tier 3.

- File drawer construction is for accommodating hanging files and NOT for stacking material on the drawer bottom.

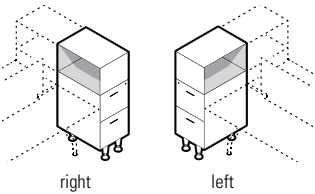

Side Towers - File/File

S1624FZL	24 x 16 x 49.85	100	121	14.75	\$1084	n/a
S1630FZL	30 x 16 x 49.85	125	137	18	\$1163	n/a
S1624FZR	24 x 16 x 49.85	100	121	14.75	\$1084	n/a
S1630FZR	30 x 16 x 49.85	125	137	18	\$1163	n/a

File/file drawers, side facing open compartment, left or right handed. Handles are standard. Lock secures all drawers. Front-to-back and side-to-side letter/legal filing capability. Matches Tier 3.

- File drawer construction is for accommodating hanging files and NOT for stacking material on the drawer bottom.

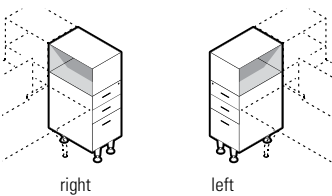

Side Towers - Box/Box/File

S1624FYL	24 x 16 x 49.85	100	124	14.75	\$1223	n/a
S1630FYL	30 x 16 x 49.85	125	140	18	\$1306	n/a
S1624FYR	24 x 16 x 49.85	100	124	14.75	\$1223	n/a
S1630FYR	30 x 16 x 49.85	125	140	18	\$1306	n/a

Box/box/file drawers, side facing open compartment, left or right handed. Handles are standard. Lock secures all drawers. Front-to-back and side-to-side letter/legal filing capability. Matches Tier 3.

- File drawer construction is for accommodating hanging files and NOT for stacking material on the drawer bottom.

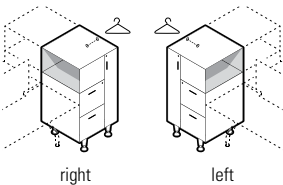

Wardrobe Side Tower - File/File

S2424FZL	24 x 24 x 49.85	100	171	21.25	\$1399	n/a
S2430FZL	30 x 24 x 49.85	125	195	25.75	\$1510	n/a
S2424FZR	24 x 24 x 49.85	100	171	21.25	\$1399	n/a
S2430FZR	30 x 24 x 49.85	125	195	25.75	\$1510	n/a

File/file drawers, side facing open compartment, wardrobe cabinet with hanging rod, left or right handed. Handles are standard. Lock secures all drawers. Front-to-back and side-to-side letter/legal filing capability. Matches Tier 3.

- File drawer construction is for accommodating hanging files and NOT for stacking material on the drawer bottom.

Required Specifications

- Top finish
- Top/edge detail
- Base finish
- Door / Drawer Front Finish
- Handles

STORAGE

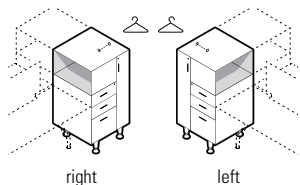

Wardrobe Side Tower - Box/Box/File

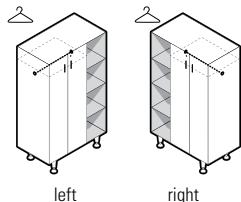

Wardrobe - Laminate Doors

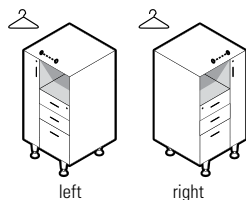

Wardrobe Tower - Box/Box/File

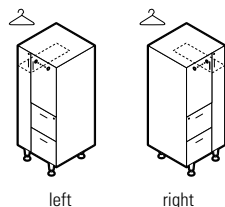

Wardrobe Tower - File/File

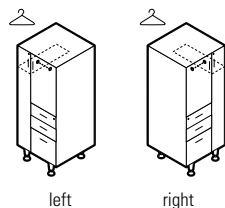

Wardrobe Tower - Box/Box/File

MODEL#	DIMENSIONS	FREIGHT CLASS	WT./LBS.	CUBIC FT.	LIST PRICE	HP ADD
--------	------------	---------------	----------	-----------	------------	--------

D x W x H

S2424FYL	24 x 24 x 49.85	100	174	21.30	\$1542	n/a
S2430FYL	30 x 24 x 49.85	125	198	25.75	\$1653	n/a
S2424FYR	24 x 24 x 49.85	100	174	21.30	\$1542	n/a
S2430FYR	30 x 24 x 49.85	125	198	25.75	\$1653	n/a

Box/box/file drawers, side facing open compartment, wardrobe cabinet with hanging rod, left or right handed. Handles are standard. Lock secures all drawers. Front-to-back and side-to-side letter/legal filing capability. Matches Tier 3.

- File drawer construction is for accommodating hanging files and NOT for stacking material on the drawer bottom.

S3620HWL	20 x 36 x 63.35	125	222	32.50	\$1431	n/a
S3624HWL	24 x 36 x 63.35	125	251	38.50	\$1547	n/a
S3620HWR	20 x 36 x 63.35	125	222	32.50	\$1431	n/a
S3624HWR	24 x 36 x 63.35	125	251	38.50	\$1547	n/a

Laminate doors are standard. Handles are standard. Full length hanging rod and hat shelf included. Includes three 3-position fixed/height adjustable shelves and one fixed shelf. Specify left or right. Standard with lock. Matches Tier 4.

S2424FVL	24 x 24 x 49.85	100	189	21	\$1588	n/a
S2430FVL	30 x 24 x 49.85	100	221	26	\$1635	n/a
S2424FVR	24 x 24 x 49.85	100	189	21	\$1588	n/a
S2430FVR	30 x 24 x 49.85	100	221	26	\$1635	n/a

Box/box/file drawers, open compartment, wardrobe cabinet with hanging rod, left or right handed. Handles are standard. Lock secures all drawers. Front-to-back and side-to-side letter/legal filing capability. Matches Tier 3.

- File drawer construction is for accommodating hanging files and NOT for stacking material on the drawer bottom.

S2424HWL	24 x 24 x 63.35	100	241	26.50	\$1774	n/a
S2430HWL	30 x 24 x 63.35	100	271	32.50	\$1820	n/a
S2424HWR	24 x 24 x 63.35	100	241	26.50	\$1820	n/a
S2430HWR	30 x 24 x 63.35	100	271	32.50	\$1820	n/a

File/file drawers, storage compartment with hinged doors, wardrobe cabinet with hanging rod and hat shelf, left or right handed. Handles are standard. Lock secures all drawers. Front-to-back and side-to-side letter/legal filing capability. Matches Tier 4.

- File drawer construction is for accommodating hanging files and NOT for stacking material on the drawer bottom.

S2424HVL	24 x 24 x 63.35	100	241	26.50	\$1894	n/a
S2430HVL	30 x 24 x 63.35	100	271	32.50	\$1936	n/a
S2424HVR	24 x 24 x 63.35	100	241	26.50	\$1894	n/a
S2430HVR	30 x 24 x 63.35	100	271	32.50	\$1936	n/a

Box/box/file drawers, storage compartment with hinged doors, wardrobe cabinet with hanging rod and hat shelf, left or right handed. Handles are standard. Lock secures all drawers. Front-to-back and side-to-side letter/legal filing capability. Matches Tier 4.

- File drawer construction is for accommodating hanging files and NOT for stacking material on the drawer bottom.

Required Specifications

Top finish	Handles
Top/edge detail	
Base finish	
Door / Drawer Front Finish	

S SIDEBAR

STORAGE

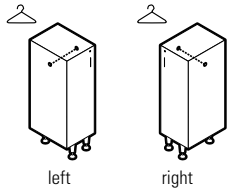

Wardrobe - Laminate Door

MODEL#	DIMENSIONS D x W x H	FREIGHT CLASS	WT/LBS.	CUBIC FT.	LIST PRICE	HP ADD
S1524FWL	24 x 15 x 49.85	125	108	13.75	\$825	n/a
S1530FWL	30 x 15 x 49.85	125	129	17	\$922	n/a
S1524FWR	24 x 15 x 49.85	125	108	13.75	\$825	n/a
S1530FWR	30 x 15 x 49.85	125	129	17	\$922	n/a

Laminate door is standard. Handles are standard. Full length hanging rod included. Specify left or right. Standard with lock. Matches Tier 3.

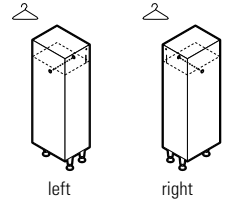

Wardrobe - Laminate Door

S1524HWL	24 x 15 x 63.35	125	135	17.25	\$950	n/a
S1530HWL	30 x 15 x 63.35	125	159	21.25	\$1051	n/a
S1524HWR	24 x 15 x 63.35	125	135	17.25	\$950	n/a
S1530HWR	30 x 15 x 63.35	125	159	21.25	\$1051	n/a

Laminate door is standard. Handles are standard. Full length hanging rod and hat shelf included. Specify left or right. Standard with lock. Matches Tier 4.

LOW CREDENZAS

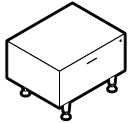

Low Credenza - Lateral Drawer

S3020AZ	20 x 30 x 22.85	100	91	11	\$755	\$116
S3024AZ	24 x 30 x 22.85	125	101	12.75	\$806	\$116
S3620AZ	20 x 36 x 22.85	125	103	13	\$820	\$116
S3624AZ	24 x 36 x 22.85	125	116	15.25	\$875	\$139

One file drawer. Handles are standard. Lock secures all drawers. Front-to-back and side-to-side letter/legal filing capability.
 • Lateral file drawer construction is for accommodating hanging files and NOT for stacking material on the drawer bottom.

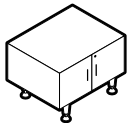

Low Credenza - Storage Cabinet

S3020AT	20 x 30 x 22.85	125	77	11	\$672	\$116
S3024AT	24 x 30 x 22.85	125	87	12.75	\$723	\$116
S3620AT	20 x 36 x 22.85	125	94	13	\$760	\$116
S3624AT	24 x 36 x 22.85	100	128	15.25	\$926	\$139

Laminate doors are standard. Handles are standard. Standard with lock.

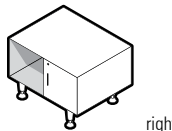
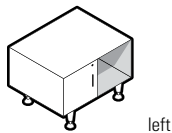

Low Credenza - Storage Compartment

S3020ATL	20 x 30 x 22.85	150	65	11	\$644	\$116
S3024ATL	24 x 30 x 22.85	125	91	12.75	\$700	\$116
S3620ATL	20 x 36 x 22.85	125	89	13	\$695	\$116
S3624ATL	24 x 36 x 22.85	100	123	15.25	\$862	\$139

S3020ATR	20 x 30 x 22.85	150	65	11	\$644	\$116
S3024ATR	24 x 30 x 22.85	125	91	12.75	\$700	\$116
S3620ATR	20 x 36 x 22.85	125	89	13	\$695	\$116
S3624ATR	24 x 36 x 22.85	100	123	15.25	\$862	\$139

Laminate door is standard on one side, open cavity on the other. Specify left or right handed. Standard with lock.

Required Specifications

Top finish
 Top/edge detail
 Base finish
 Door / Drawer Front Finish

Handles

Optional Specifications

HP Laminate (Low Credenzas only)

LOW CREDENZAS

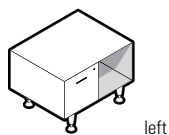

left

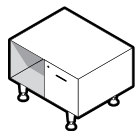

right

Low Credenza - File Drawer Storage

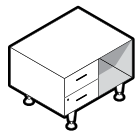

left

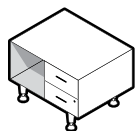

right

Low Credenza - Box/Box Storage

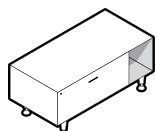

left

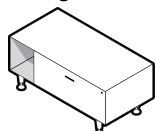

right

Low Credenza - Lateral Drawer

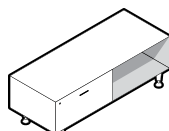

left

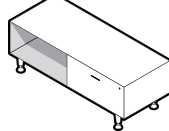

right

Low Credenza - Lateral Drawer

MODEL#	DIMENSIONS	FREIGHT CLASS	WT./LBS.	CUBIC FT.	LIST PRICE	HP ADD
--------	------------	---------------	----------	-----------	------------	--------

D x W x H

S3020ASL	20 x 30 x 22.85	125	84	11	\$704	\$116
S3024ASL	24 x 30 x 22.85	125	95	12.75	\$760	\$116
S3620ASL	20 x 36 x 22.85	125	93	13	\$750	\$116
S3624ASL	24 x 36 x 22.85	125	106	15.25	\$811	\$139

S3020ASR	20 x 30 x 22.85	125	84	11	\$704	\$116
S3024ASR	24 x 30 x 22.85	125	95	12.75	\$760	\$116
S3620ASR	20 x 36 x 22.85	125	93	13	\$750	\$116
S3624ASR	24 x 36 x 22.85	125	106	15.25	\$811	\$139

File drawer is standard on one side, open cavity on the other. Handles are standard. Specify left or right handed. Standard with lock. Front-to-back and side-to-side letter/legal filing capability.

- File drawer construction is for accommodating hanging files and NOT for stacking material on the drawer bottom.

S3020ARL	20 x 30 x 22.85	125	86	11	\$755	\$116
S3024ARL	24 x 30 x 22.85	125	98	12.75	\$811	\$116
S3620ARL	20 x 36 x 22.85	125	95	13	\$801	\$116
S3624ARL	24 x 36 x 22.85	125	108	15.25	\$862	\$139

S3020ARR	20 x 30 x 22.85	125	86	11	\$755	\$116
S3024ARR	24 x 30 x 22.85	125	98	12.75	\$811	\$116
S3620ARR	20 x 36 x 22.85	125	95	13	\$801	\$116
S3624ARR	24 x 36 x 22.85	125	108	15.25	\$862	\$139

Box/box drawer is standard on one side, open cavity on the other. Handles are standard. Specify left or right handed. Standard with lock. Front-to-back and side-to-side letter/legal filing capability.

S4220ASL	20 x 42 x 22.85	125	110	15	\$880	\$139
S4224ASL	24 x 42 x 22.85	125	123	17.50	\$945	\$163
S4820ASL	20 x 48 x 22.85	125	121	17	\$954	\$163
S4824ASL	24 x 48 x 22.85	125	136	20	\$1019	\$186

S4220ASR	20 x 42 x 22.85	125	110	15	\$880	\$139
S4224ASR	24 x 42 x 22.85	125	123	17.50	\$945	\$163
S4820ASR	20 x 48 x 22.85	125	121	17	\$954	\$163
S4824ASR	24 x 48 x 22.85	125	136	20	\$1019	\$186

Lateral file drawer is standard on one side, open cavity on the other. Handles are standard. Specify left or right handed. Standard with lock. Front-to-back and side-to-side letter/legal filing capability.

- 42" w cabinet has a 30" w lateral drawer.
- 48" w cabinet has a 36" w lateral drawer.
- Lateral file drawer construction is for accommodating hanging files and NOT for stacking material on the drawer bottom.

S6020ASL	20 x 60 x 22.85	125	138	21	\$1051	\$209
S6024ASL	24 x 60 x 22.85	125	156	24.75	\$1125	\$232
S7220ASL	20 x 72 x 22.85	125	159	20.75	\$1172	\$232
S7224ASL	24 x 72 x 22.85	125	179	25	\$1250	\$278

S6020ASR	20 x 60 x 22.85	125	138	21	\$1051	\$209
S6024ASR	24 x 60 x 22.85	125	156	24.75	\$1125	\$232
S7220ASR	20 x 72 x 22.85	125	159	20.75	\$1172	\$232
S7224ASR	24 x 72 x 22.85	125	179	25	\$1250	\$278

Lateral file drawer is standard on one side, open cavity on the other. Specify left or right handed. Standard with lock. Front-to-back and side-to-side letter/legal filing capability.

- 60" w cabinet has a 30" w lateral drawer.
- 72" w cabinet has a 36" w lateral drawer.
- Lateral file drawer construction is for accommodating hanging files and NOT for stacking material on the drawer bottom.

Required Specifications

Top finish
Top/edge detail
Base finish
Door / Drawer Front Finish

Handles

Optional Specifications

HP laminate

LOW CREDENZAS

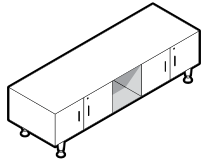

Low Credenza - Storage Cabinets

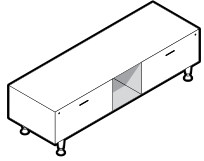

Low Credenza - Lateral Files

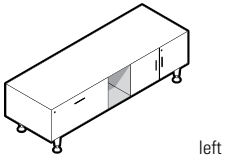

left

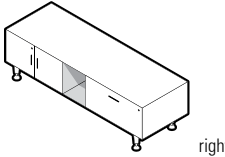

right

Low Credenza - Mixed Storage

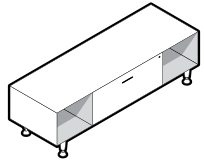

Low Credenza - Center Lateral File

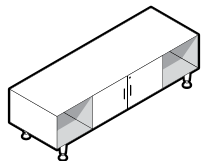

Low Credenza - Center Storage Cabinet

MODEL#	DIMENSIONS	FREIGHT CLASS	WT/LBS.	CUBIC FT.	LIST PRICE	HP ADD
--------	------------	---------------	---------	-----------	------------	--------

D x W x H

S7220AN	20 x 72 x 22.85	125	163	20.75	\$1264	\$232
S7224AN	24 x 72 x 22.85	125	189	25	\$1348	\$278
S8420AN	20 x 84 x 22.85	125	184	29	\$1297	\$278
S8424AN	24 x 84 x 22.85	125	211	34.50	\$1380	\$325

Laminate doors are standard on left and right, open cavity in the center. Handles are standard. Standard with locks.

- 72" w cabinet has two 30" w storage cabinets.
- 84" w cabinet has two 36" w storage cabinets.

S7220AP	20 x 72 x 22.85	100	183	20.75	\$1413	\$232
S7224AP	24 x 72 x 22.85	100	205	25	\$1496	\$278
S8420AP	20 x 84 x 22.85	125	205	29	\$1547	\$278
S8424AP	24 x 84 x 22.85	125	230	34.50	\$1653	\$325

Lateral files are standard on left and right, open cavity in the center. Handles are standard. Standard with locks.

- 72" w cabinet has two 30" w lateral drawers.
- 84" w cabinet has two 36" w lateral drawers.
- Lateral file drawer construction is for accommodating hanging files and NOT for stacking material on the drawer bottom.

S7220AML	20 x 72 x 22.85	100	170	20.75	\$1315	\$232
S7224AML	24 x 72 x 22.85	125	191	25	\$1399	\$278
S8420AML	20 x 84 x 22.85	125	191	29	\$1436	\$278
S8424AML	24 x 84 x 22.85	125	216	34.50	\$1538	\$325

S7220AMR	20 x 72 x 22.85	100	170	20.75	\$1315	\$232
S7224AMR	24 x 72 x 22.85	125	191	25	\$1399	\$278
S8420AMR	20 x 84 x 22.85	125	191	29	\$1436	\$278
S8424AMR	24 x 84 x 22.85	125	216	34.50	\$1538	\$325

Lateral file is standard on one side, laminate doors are standard on on side, open cavity in the center. Handles are standard. Specify left or right handed. Standard with locks.

- 72" w cabinet has one 30" w lateral drawer and one 30" w storage cabinet.
- 84" w cabinet has one 36" w lateral drawer and one 36" w storage cabinet.
- Lateral file drawer construction is for accommodating hanging files and NOT for stacking material on the drawer bottom.

S7220AS	20 x 72 x 22.85	125	162	20.75	\$1176	\$232
S7224AS	24 x 72 x 22.85	125	184	25	\$1264	\$278

Open cavities are standard on left and right, lateral file is standard in the center. Handles are standard. Standard with locks.

- 36" w lateral file
- Lateral file drawer construction is for accommodating hanging files and NOT for stacking material on the drawer bottom.

S7220AT	20 x 72 x 22.85	125	155	20.75	\$1088	\$232
S7224AT	24 x 72 x 22.85	125	180	24.50	\$1167	\$278

Open cavities are standard on left and right, laminate doors are standard in the center. Handles are standard. Standard with locks.

- 36" w storage cabinet

Required Specifications

Top finish
Top/edge detail
Base finish
Door / Drawer Front Finish

Handles

Optional Specifications

HP laminate

LOW CREDENZAS

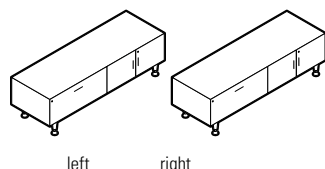

left right
Low Credenza - Mixed Storage

MODEL#	DIMENSIONS D x W x H	FREIGHT CLASS	WT/LBS.	CUBIC FT.	LIST PRICE	HP ADD
S7220AKL	20 x 72 x 22.85	100	170	20.75	\$1348	\$232
S7224AKL	24 x 72 x 22.85	125	191	25	\$1431	\$278
S7220AKR	20 x 72 x 22.85	100	170	20.75	\$1348	\$232
S7224AKR	24 x 72 x 22.85	125	191	25	\$1431	\$278

Lateral file is standard on one side, laminate doors are standard on the other side. Handles are standard. Specify left or right handed. Standard with locks.

- 36" w storage cabinet
- 36" w lateral file
- Lateral file drawer construction is for accommodating hanging files and NOT for stacking material on the drawer bottom.

MEDIUM CREDENZAS

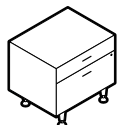

Medium Credenza - Box/File

S3020BZ	20 x 30 x 29.6	100	113	13.75	\$936	\$116
S3024BZ	24 x 30 x 29.6	125	126	16.25	\$996	\$116
S3620BZ	20 x 36 x 29.6	125	128	16.25	\$1024	\$116
S3624BZ	24 x 36 x 29.6	100	142	16.75	\$1084	\$139

Wide box and lateral file. Handles are standard. Lock secures both drawers.

- Lateral file drawer construction is for accommodating hanging files and NOT for stacking material on the drawer bottom.

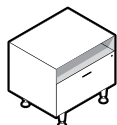

Medium Credenza w/Lateral File

S3020BY	20 x 30 x 29.6	100	116	13.75	\$889	\$116
S3024BY	24 x 30 x 29.6	100	131	16.25	\$959	\$116
S3620BY	20 x 36 x 29.6	100	132	16.25	\$977	\$116
S3624BY	24 x 36 x 29.6	100	149	16.75	\$1051	\$139

Open cavity and lateral file. Handles are standard. Standard with lock.

- Lateral file drawer construction is for accommodating hanging files and NOT for stacking material on the drawer bottom.

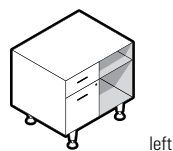

left

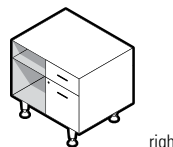

right

Medium Credenza - Box/File

S3020BRL	20 x 30 x 29.6	100	129	13.75	\$889	\$116
S3024BRL	24 x 30 x 29.6	100	134	16.25	\$968	\$116
S3620BRL	20 x 36 x 29.6	100	131	16.25	\$954	\$116
S3624BRL	24 x 36 x 29.6	100	149	16.75	\$1033	\$139

S3020BRR	20 x 30 x 29.6	100	129	13.75	\$889	\$116
S3024BRR	24 x 30 x 29.6	100	134	16.25	\$968	\$116
S3620BRR	20 x 36 x 29.6	100	131	16.25	\$954	\$116
S3624BRR	24 x 36 x 29.6	100	149	16.75	\$1033	\$139

Box/file is standard on one side, open cavity with one 3-position fixed/adjustable shelf on the other. Handles are standard. Specify left or right handed. Standard with lock. Front-to-back and side-to-side letter/legal filing capability.

- File drawer construction is for accommodating hanging files and NOT for stacking material on the drawer bottom.

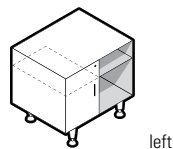

left

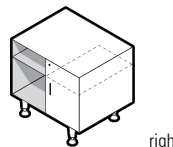

right

Medium Credenza - Storage Compartment

S3020BNL	20 x 30 x 29.6	100	113	13.75	\$788	\$116
S3024BNL	24 x 30 x 29.6	125	129	16.25	\$866	\$116
S3620BNL	20 x 36 x 29.6	125	116	16.25	\$852	\$116
S3624BNL	24 x 36 x 29.6	125	133	16.75	\$940	\$139

S3020BNR	20 x 30 x 29.6	100	113	13.75	\$788	\$116
S3024BNR	24 x 30 x 29.6	125	129	16.25	\$866	\$116
S3620BNR	20 x 36 x 29.6	125	116	16.25	\$852	\$116
S3624BNR	24 x 36 x 29.6	125	133	16.75	\$940	\$139

Laminate door is standard on one side, open cavity with one 3-position fixed/adjustable shelf on the other. Handles are standard Specify left or right handed. Standard with lock.

Required Specifications

Top finish
Top/edge detail
Base finish
Door / Drawer Front Finish

Handles

Optional Specifications

HP laminate

MEDIUM CRENZAS

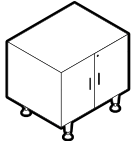

Medium Credenza - Storage Cabinet

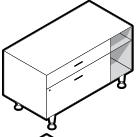

left

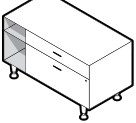

right

Medium Credenza - Box/Lateral File



left

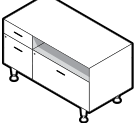

right

Medium Credenza - Mixed Drawers

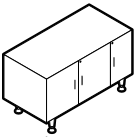

left

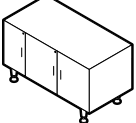

right

Medium Credenza - 3 Doors

MODEL#	DIMENSIONS D x W x H	FREIGHT CLASS	WT./LBS.	CUBIC FT.	LIST PRICE	HP ADD
S3020BT	20 x 30 x 29.6	125	106	13.50	\$709	\$116
S3024BT	24 x 30 x 29.6	125	122	16	\$880	\$116
S3620BT	20 x 36 x 29.6	100	131	16.25	\$945	\$116
S3624BT	24 x 36 x 29.6	100	150	16.25	\$1028	\$139

Laminate doors are standard. Includes one fixed shelf. Handles are standard. Standard with lock.

S4220BSL	20 x 42 x 29.6	125	142	18.75	\$1107	\$139
S4224BSL	24 x 42 x 29.6	125	160	22	\$1181	\$163
S4820BSL	20 x 48 x 29.6	125	155	21.25	\$1200	\$163
S4824BSL	24 x 48 x 29.6	125	173	25	\$1278	\$186

S4220BSR	20 x 42 x 29.6	125	142	18.75	\$1107	\$139
S4224BSR	24 x 42 x 29.6	125	160	22	\$1181	\$163
S4820BSR	20 x 48 x 29.6	125	155	21.25	\$1200	\$163
S4824BSR	24 x 48 x 29.6	125	173	25	\$1278	\$186

Wide box and lateral file is standard on one side, open cavity with fixed shelf one 3-position fixed/adjustable shelf on the other. Handles are standard. Specify left or right handed. Standard with lock. Front-to-back and side-to-side letter/legal filing capability.

- 42" w credenza has a 30" w box/lateral file
- 48" w credenza has a 36" w box/lateral file
- Lateral file drawer construction is for accommodating hanging files and NOT for stacking material on the drawer bottom.

S4220BQL	20 x 42 x 29.6	100	165	18.75	\$1408	\$139
S4224BQL	24 x 42 x 29.6	100	184	22	\$1496	\$163
S4820BQL	20 x 48 x 29.6	100	179	21.25	\$1500	\$163
S4824BQL	24 x 48 x 29.6	100	184	22	\$1496	\$186

S4220BQR	20 x 42 x 29.6	100	165	18.75	\$1408	\$139
S4224BQR	24 x 42 x 29.6	100	184	22	\$1496	\$163
S4820BQR	20 x 48 x 29.6	100	179	21.25	\$1500	\$163
S4824BQR	24 x 48 x 29.6	100	184	22	\$1496	\$186

Box/file is standard on one side, open cavity and lateral file on the other side. Specify left or right handed. Handles are standard. Standard with locks. Front-to-back and side-to-side letter/legal filing capability.

- 42" w credenza has a 30" w lateral drawer
- 48" w credenza has a 36" w lateral drawer
- Lateral file drawer construction is for accommodating hanging files and NOT for stacking material on the drawer bottom.

S4220BTL	20 x 42 x 29.6	125	140	18.75	\$1075	\$139
S4224BTL	24 x 42 x 29.6	125	161	22.25	\$1167	\$163
S4820BTL	20 x 48 x 29.6	125	154	22.25	\$1158	\$163
S4824BTL	24 x 48 x 29.6	125	176	25.25	\$1260	\$186

S4220BTR	20 x 42 x 29.6	125	140	18.75	\$1075	\$139
S4224BTR	24 x 42 x 29.6	125	161	22.25	\$1167	\$163
S4820BTR	20 x 48 x 29.6	125	154	22.25	\$1158	\$163
S4824BTR	24 x 48 x 29.6	125	176	25.25	\$1260	\$186

Laminate doors are standard. Includes one fixed shelf. Specify left or right handed. Handles are standard. Standard with locks.

- 42" w credenza has a 30" w storage cabinet
- 48" w credenza has a 36" w storage cabinet

Required Specifications

Top finish
Top/edge detail
Base finish
Door / Drawer Front Finish

Handles

Optional Specifications

HP laminate

MEDIUM CREDENZAS

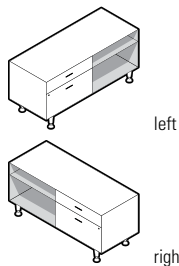

Medium Credenza - Box/Lateral

MODEL#	DIMENSIONS D x W x H	FREIGHT CLASS	WT/LBS.	CUBIC FT.	LIST PRICE	HP ADD
S6020BRL	20 x 60 x 29.6	125	182	26.50	\$1329	\$209
S6024BRL	24 x 60 x 29.6	125	205	31	\$1417	\$232
S7220BRL	20 x 72 x 29.6	125	208	31.50	\$1482	\$232
S7224BRL	24 x 72 x 29.6	125	234	37	\$1579	\$278
S6020BRR	20 x 60 x 29.6	125	182	26.50	\$1329	\$209
S6024BRR	24 x 60 x 29.6	125	205	31	\$1417	\$232
S7220BRR	20 x 72 x 29.6	125	208	31.50	\$1482	\$232
S7224BRR	24 x 72 x 29.6	125	234	37	\$1579	\$278

Wide box and lateral file is standard on one side, open cavity with 3-position fixed/adjustable shelf on the other. Handles are standard. Specify left or right handed. Standard with lock. Front-to-back and side-to-side letter/legal filing capability.

- 60" w cabinet has a 30" w box/file drawer.
- 72" w cabinet has a 36" w box/file drawer.
- Lateral file drawer construction is for accomodating hanging files and NOT for stacking material on the drawer bottom.

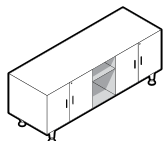

Medium Credenza - Storage Cabinets

S7220BN	20 x 72 x 29.6	125	230	31.50	\$1551	\$232
S7224BN	24 x 72 x 29.6	125	265	37.50	\$1690	\$278
S8420BN	20 x 84 x 29.6	125	262	38.75	\$1709	\$278
S8424BN	24 x 84 x 29.6	100	300	37.50	\$1862	\$325

Laminate doors are standard on left and right, open cavity with 3-position fixed/adjustable shelf in the center. Handles are standard. Standard with locks.

- 72" w cabinet has two 30" w storage cabinets.
- 84" w cabinet has two 36" w storage cabinets.

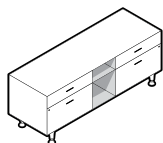

Medium Credenza - Box/Lateral Files

S7220BS	20 x 72 x 29.6	125	235	31.50	\$1792	\$232
S7224BS	24 x 72 x 29.6	125	260	37	\$1889	\$278
S8420BS	20 x 84 x 29.6	125	261	36.50	\$1968	\$278
S8424BS	24 x 84 x 29.6	125	290	37.25	\$2061	\$325

Wide box and lateral files are standard on left and right, open cavity with 3-position fixed/adjustable shelf in the center. Handles are standard. Standard with locks.

- 72" w cabinet has two 30" w box/lateral file drawers.
- 84" w cabinet has two 36" w box/lateral file drawers.

BACK-TO-BACK CREDENZAS

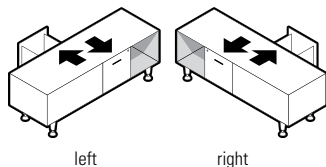

Back-to-Back Low Credenza - File Drawer

S6020ANL	20 x 60 x 22.85	100	172	21.25	\$1237	\$209
S7220ANL	20 x 72 x 22.85	125	190	25.25	\$1297	\$232
S6020ANR	20 x 60 x 22.85	100	172	21.25	\$1237	\$209
S7220ANR	20 x 72 x 22.85	125	190	25.25	\$1297	\$232

File drawers and open cavities are standard on either side of the credenza. For use between two adjacent workstations. Handles are standard. Standard with locks.

- 60" w cabinet has a 14" w open cavity.
- 72" w cabinet has a 20" w open cavity.
- File drawer construction is for accomodating hanging files and NOT for stacking material on the drawer bottom.

Required Specifications

Top finish
Top/edge detail
Base finish
Door / Drawer Front Finish

Handles

Optional Specifications

HP laminate

BACK-TO-BACK CREDENZAS

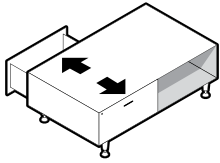

Back-to-Back Low, Deep Credenza - Lateral File

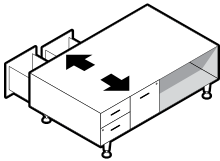

Back-to-Back Low, Deep Credenza - Mixed Drawers

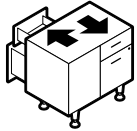

Back-to-Back Medium Credenza - Box/File

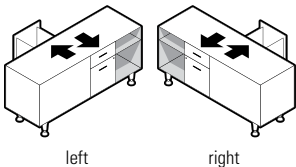

Back-to-Back Medium Credenza - Box/File

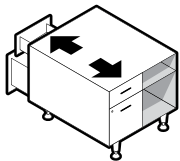

Back-to-Back Medium, Deep Credenza - Box/File

MODEL#	DIMENSIONS D x W x H	FREIGHT CLASS	WT/LBS.	CUBIC FT.	LIST PRICE	HP ADD
S6037AS	37.4 x 60 x 22.85	125	247	37.75	\$1584	\$371
S7237AS	37.4 x 72 x 22.85	125	285	44.75	\$1769	\$440

Lateral file drawers and open cavities are standard on either side of the credenza. For use between two adjacent workstations. Handles are standard. Standard with locks.

- 60" w credenza has a 30" w lateral drawer.
- 72" w credenza has a 36" w lateral drawer.
- Lateral file drawer construction is for accomodating hanging files and NOT for stacking material on the drawer bottom.

S6037AQ	37.4 x 60 x 22.85	125	281	37.75	\$1913	\$371
S7237AQ	37.4 x 72 x 22.85	125	314	44.75	\$2042	\$440

Box/File, file drawers and open cavities are standard on either side of the credenza. For use between two adjacent workstations. Handles are standard. Standard with locks.

- 60" w credenza has a 28" w open cavity.
- 72" w credenza has a 40" w open cavity.
- File drawer construction is for accomodating hanging files and NOT for stacking material on the drawer bottom.

S3320BU	20 x 33.25 x 29.6	92.5	148	14.75	\$1241	\$116
---------	-------------------	------	-----	-------	---------------	--------------

Box/file drawers standard on either side of the credenza. For use between two adjacent workstations. Handles are standard. Standard with locks.

- File drawer construction is for accomodating hanging files and NOT for stacking material on the drawer bottom.

S6020BPL	20 x 60 x 29.6	100	228	26.50	\$1649	\$209
S7220BPL	20 x 72 x 29.6	100	254	31.50	\$1737	\$232

S6020BPR	20 x 60 x 29.6	100	228	26.50	\$1649	\$209
S7220BPR	20 x 72 x 29.6	100	254	31.50	\$1737	\$232

Box/file drawers and open cavities with one 3-position fixed/adjustable shelf are standard on either side of the credenza. For use between two adjacent workstations. Handles are standard. Standard with locks.

- File drawer construction is for accomodating hanging files and NOT for stacking material on the drawer bottom.

S3037BR	37.4 x 30 x 29.6	100	205	24.50	\$1459	\$186
---------	------------------	-----	-----	-------	---------------	--------------

Box/File drawers and open cavities with one 3-position fixed/adjustable shelf are standard on either side of the credenza. For use between two adjacent workstations. Handles are standard. Standard with locks.

- File drawer construction is for accomodating hanging files and NOT for stacking material on the drawer bottom.

Required Specifications

Top finish
Top/edge detail
Base finish
Door / Drawer Front Finish

Handles

Optional Specifications

HP laminate

BACK-TO-BACK CRENZAS

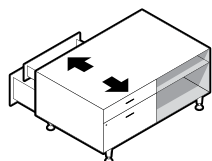

Back-to-Back Medium, Deep Credenza - Box/Lateral File

MODEL#	DIMENSIONS D x W x H	FREIGHT CLASS	WT./LBS.	CUBIC FT.	LIST PRICE	HP ADD
S6037BR	37.4 x 60 x 29.6	125	311	47	\$2051	\$371
S7237BR	37.4 x 72 x 29.6	125	358	56.25	\$2297	\$440

Wide box and lateral file drawers and open cavities with one 3-position fixed/adjustable shelf are standard on either side of the credenza. For use between two adjacent workstations. Handles are standard. Standard with locks.

- 60" w credenza has 30" w box/file drawers.
- 72" w credenza has 36" w box/file drawers.
- File drawer construction is for accomodating hanging files and NOT for stacking material on the drawer bottom.

STACK-ON STORAGE

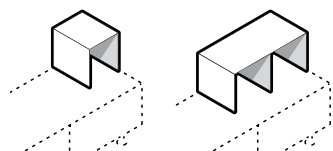

Stack-On Bookcases

S1214AO	14.3 x 12 x 13.5	92.5	23	2.20	\$172	n/a
S2414AO	14.3 x 24 x 13.5	100	37	4	\$264	n/a
S3014AO	14.3 x 30 x 13.5	100	41	5	\$292	n/a
S3614AO	14.3 x 36 x 13.5	125	46	5.90	\$320	n/a

Designed to be placed on top of credenzas. Open cavity. Unit rests directly on credenza top.

- Sxx14AO Stack-On bookcases add 1 tier when placed on any storage unit.

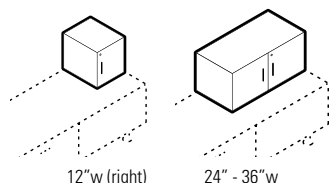

Stack-On Storage Cabinet

S1215ATL	15 x 12 x 13.5	92.5	26	2.30	\$241	n/a
S1215ATR	15 x 12 x 13.5	92.5	26	2.30	\$241	n/a
S2415AT	15 x 24 x 13.5	92.5	43	4.20	\$399	n/a
S3015AT	15 x 30 x 13.5	100	49	5.20	\$436	n/a
S3615AT	15 x 36 x 13.5	100	55	6.20	\$477	n/a

Designed to be placed on top of credenzas. Laminate doors are standard on one side, open cavity on the other side. Specify left or right handed. Handles are standard. Standard with locks. Unit rests directly on credenza top.

- Sxx15AT/ATL/ATR Stack-On storage cabinets add 1 tier when placed on any storage unit.

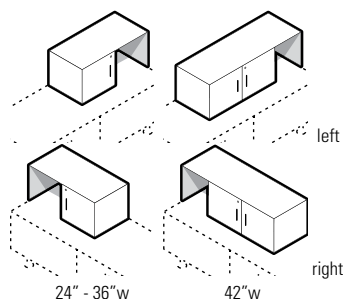

Stack-On Mixed Storage Cabinet

S2415ANL	15 x 24 x 13.5	100	40	4.20	\$334	n/a
S3015ANL	15 x 30 x 13.5	100	45	5.20	\$362	n/a
S3615ANL	15 x 36 x 13.5	100	51	6.20	\$399	n/a
S4215ANL	15 x 42 x 13.5	100	63	7.25	\$528	n/a
S2415ANR	15 x 24 x 13.5	100	40	4.20	\$334	n/a
S3015ANR	15 x 30 x 13.5	100	45	5.20	\$362	n/a
S3615ANR	15 x 36 x 13.5	100	51	6.20	\$399	n/a
S4215ANR	15 x 42 x 13.5	100	63	7.25	\$528	n/a

Designed to be placed on top of credenzas. Laminate doors are standard on one side, open cavity on the other side. Specify left or right handed. Handles are standard. Standard with locks. Unit rests directly on credenza top.

- Sxx15ANL/ANR Stack-On mixed storage cabinets add 1 tier when placed on any storage unit.

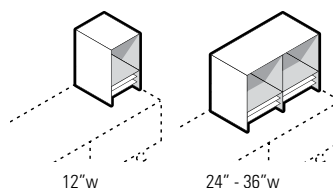

Stack-On Bookcase w/Collators

S1214B0	14.3 x 12 x 20.25	92.5	35	3.10	\$250	n/a
S2414B0	14.3 x 24 x 20.25	92.5	59	5.75	\$413	n/a
S3014B0	14.3 x 30 x 20.25	100	68	7	\$463	n/a
S3614B0	14.3 x 36 x 20.25	100	77	8.50	\$533	n/a

Designed to be placed on top credenzas. Open cavity with collator below. Unit rests directly on credenza top.

- Sxx14B0 Stack-On bookcases add 1.5 tiers when placed on any storage unit.

Required Specifications

Top finish
Top/edge detail
Base finish
Door/Drawer Front Finish (Storage Cabinets only)

Handles (Storage Cabinets only)
Collator Finish (Bookcase with Collator only)

Optional Specifications

HP laminate

STACK-ON STORAGE

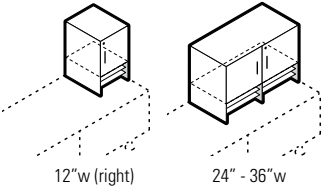

Stack-On Closed Storage Cabinet w/Collators

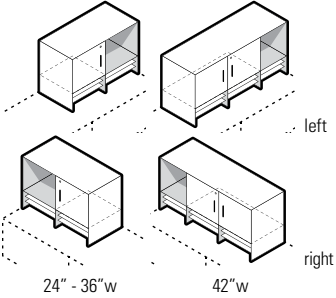

Stack-On Mixed Storage Cabinet w/Collators

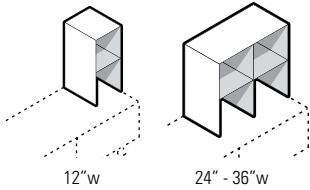

Stack-On Bookcases

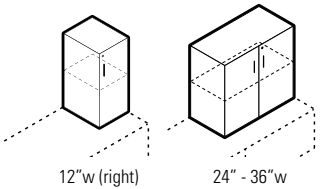

Stack-On Storage Cabinet

MODEL#	DIMENSIONS D x W x H	FREIGHT CLASS	WT/LBS.	CUBIC FT.	LIST PRICE	HP ADD
S1215BTL	15 x 12 x 20.25	92.5	38	3.30	\$315	n/a
S1215BTR	15 x 12 x 20.25	92.5	38	3.30	\$315	n/a
S2415BT	15 x 24 x 20.25	92.5	66	6	\$547	n/a
S3015BT	15 x 30 x 20.25	92.5	75	7.50	\$607	n/a
S3615BT	15 x 36 x 20.25	100	86	9	\$690	n/a

Designed to be placed on top of credenzas. Laminate doors are standard with collator below. For 12" w units specify left or right handed. Handles are standard. Standard with locks. Unit rests directly on credenza top.

- Sxx15BTL/BTR Stack-On storage cabinets add 1.5 tiers when placed on any storage unit.

S2415BNL	15 x 24 x 20.25	92.5	63	6	\$482	n/a
S3015BNL	15 x 30 x 20.25	100	72	7.50	\$533	n/a
S3615BNL	15 x 36 x 20.25	100	81	9	\$612	n/a
S4215BNL	15 x 42 x 20.25	100	100	10.25	\$764	n/a
S2415BNR	15 x 24 x 20.25	92.5	63	6	\$482	n/a
S3015BNR	15 x 30 x 20.25	100	72	7.50	\$533	n/a
S3615BNR	15 x 36 x 20.25	100	81	9	\$612	n/a
S4215BNR	15 x 42 x 20.25	100	100	10.25	\$764	n/a

Designed to be placed on top of credenzas. Laminate doors are standard one one side, open cavity on the other side with collator below. Specify left or right handed. Handles are standard. Standard with locks. Unit rests directly on credenza top.

- Sxx15BNL/BNR Stack-On mixed storage cabinets add 1.5 tiers when placed on any storage unit.

S1214DO	14.3 x 12 x 27	92.5	41	4	\$283	n/a
S2414DO	14.3 x 24 x 27	100	68	7.50	\$445	n/a
S3014DO	14.3 x 30 x 27	100	76	9.25	\$487	n/a
S3614DO	14.3 x 36 x 27	125	85	11	\$542	n/a

Designed to be placed on top of credenzas. Open cavities with 3-position fixed/adjustable shelf. Unit rests directly on credenza top.

- Sxx14DO Stack-On bookcases add 2 tiers when placed on any storage unit.

S1215DTL	15 x 12 x 27	92.5	47	4.20	\$371	n/a
S1215DTR	15 x 12 x 27	92.5	47	4.20	\$371	n/a
S2415DT	15 x 24 x 27	92.5	79	7.75	\$621	n/a
S3015DT	15 x 30 x 27	100	91	9.50	\$681	n/a
S3615DT	15 x 36 x 27	100	103	11.25	\$760	n/a

Designed to be placed on top of credenzas. Laminate doors are standard. Includes 3-position fixed/adjustable shelf. For 12" w units specify left or right handed. Handles are standard. Standard with locks. Unit rests directly on credenza top.

- Sxx15DT/DTL/DTR Stack-On storage cabinets add 2 tiers when placed on any storage unit.

Required Specifications

Top finish
Top/edge detail
Base finish
Door/Drawer Front Finish (Storage Cabinets only)

Handles (Storage Cabinets only)
Collator Finish (Units with Collator only)

STACK-ON STORAGE

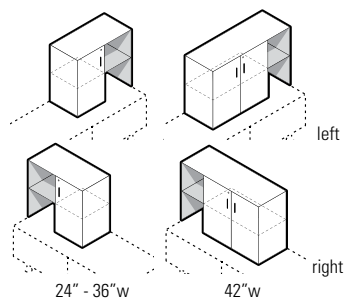

Stack-On Mixed Storage Cabinet

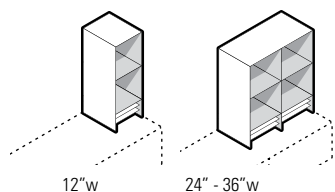

Stack-On Bookcase w/Collators

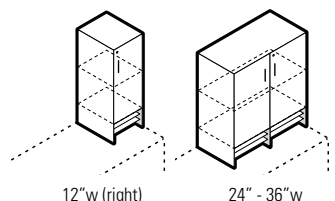

Stack-On Closed Storage Cabinet w/Collators

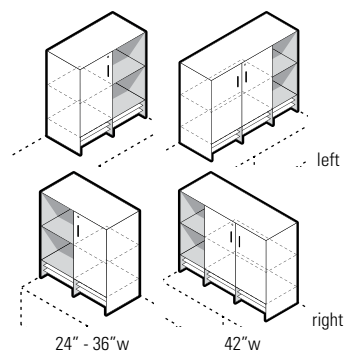

Stack-On Mixed Storage Cabinet w/Collators

MODEL#	DIMENSIONS	FREIGHT CLASS	WT/LBS.	CUBIC FT.	LIST PRICE	HP ADD
D x W x H						
S2415DNL	15 x 24 x 27	100	73	7.75	\$533	n/a
S3015DNL	15 x 30 x 27	100	83	9.50	\$584	n/a
S3615DNL	15 x 36 x 27	100	94	11.25	\$653	n/a
S4215DNL	15 x 42 x 27	100	117	13	\$838	n/a
S2415DNR	15 x 24 x 27	100	73	7.75	\$533	n/a
S3015DNR	15 x 30 x 27	100	83	9.50	\$584	n/a
S3615DNR	15 x 36 x 27	100	94	11.25	\$653	n/a
S4215DNR	15 x 42 x 27	100	117	13	\$838	n/a

Designed to be placed on top of credenzas. Laminate doors are standard on one side with one 3-position fixed/adjustable shelf. Open cavity with one 3-position fixed/adjustable shelf on the other side. Specify left or right handed. Handles are standard. Standard with locks. Unit rests directly on credenza top.

- Sxx15DNL/DNR Stack-On mixed storage cabinets add 2 tiers when placed on any storage unit.

S1214EO	14.3 x 12 x 33.75	92.5	53	5	\$366	n/a
S2414EO	14.3 x 24 x 33.75	100	90	9.25	\$607	n/a
S3014EO	14.3 x 30 x 33.75	100	102	11.25	\$672	n/a
S3614EO	14.3 x 36 x 33.75	100	115	13.25	\$764	n/a

Designed to be placed on top of credenzas. Open cavities with one 3-position fixed/adjustable shelf and collator below. Unit rests directly on credenza top.

- Sxx14EO Stack-On bookcases add 2.5 tiers when placed on any storage unit.

S1215ETL	15 x 12 x 33.75	92.5	59	5.25	\$454	n/a
S1215ETR	15 x 12 x 33.75	92.5	59	5.25	\$454	n/a
S2415ET	15 x 24 x 33.75	92.5	102	9.50	\$778	n/a
S3015ET	15 x 30 x 33.75	100	117	11.75	\$862	n/a
S3615ET	15 x 36 x 33.75	100	133	14	\$977	n/a

Designed to be placed on top of credenzas. Laminate doors are standard with one 3-position fixed/adjustable shelf and collator below. For 12\"w units specify left or right handed. Handles are standard. Standard with locks. Unit rests directly on credenza top.

- Sxx15ET/ETL/ETR Stack-On storage cabinets add 2.5 tiers when placed on any storage unit.

S2415ENL	15 x 24 x 33.75	92.5	96	9.50	\$690	n/a
S3015ENL	15 x 30 x 33.75	100	110	11.75	\$769	n/a
S3615ENL	15 x 36 x 33.75	100	124	14	\$871	n/a
S4215ENL	15 x 42 x 33.75	100	154	16	\$1088	n/a
S2415ENR	15 x 24 x 33.75	92.5	96	9.50	\$690	n/a
S3015ENR	15 x 30 x 33.75	100	110	11.75	\$769	n/a
S3615ENR	15 x 36 x 33.75	100	124	14	\$871	n/a
S4215ENR	15 x 42 x 33.75	100	154	16	\$1088	n/a

Designed to be placed on top of credenzas. Laminate doors are standard on one side with one 3-position fixed/adjustable shelf. Open cavities on the other side, with one 3-position fixed/adjustable shelf and collator below. Specify left or right handed. Handles are standard. Standard with locks. Unit rests directly on credenza top.

- Sxx15ENL/ENR Stack-On mixed storage cabinets add 2.5 tiers when placed on any storage unit.

Required Specifications

Top finish
 Top/edge detail
 Base finish
 Door/Drawer Front Finish (Storage Cabinets only)

Handles (Storage Cabinets only)
 Collator Finish (Units with Collator only)

STACK-ON STORAGE

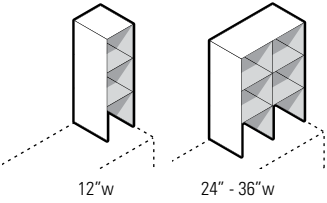

Stack-On Bookcases

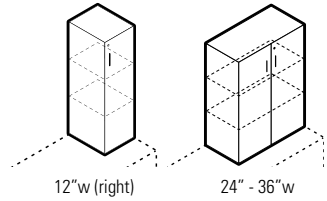

Stack-On Storage Cabinet

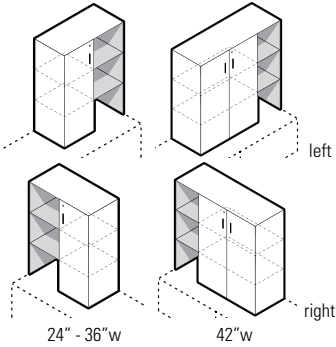

Stack-On Mixed Storage Cabinet

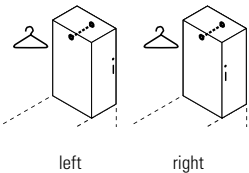

Stack-On Wardrobe Cabinet

MODEL#	DIMENSIONS D x W x H	FREIGHT CLASS	WT/LBS.	CUBIC FT.	LIST PRICE	HP ADD
S1214FO	14.3 x 12 x 40.5	100	59	6	\$394	n/a
S2414FO	14.3 x 24 x 40.5	100	98	10.75	\$616	n/a
S3014FO	14.3 x 30 x 40.5	100	110	13.25	\$676	n/a
S3614FO	14.3 x 36 x 40.5	125	123	15.75	\$750	n/a

Designed to be placed on top of credenzas. Open cavities with two 3-position fixed/adjustable shelves. Unit rests directly on credenza top.

- Sxx14FO Stack-On bookcases add 3 tiers when placed on any storage unit.

S1215FTL	15 x 12 x 40.5	92.5	68	6.25	\$505	n/a
S1215FTR	15 x 12 x 40.5	92.5	68	6.25	\$505	n/a
S2415FT	15 x 24 x 40.5	92.5	116	11.25	\$843	n/a
S3015FT	15 x 30 x 40.5	100	132	14	\$926	n/a
S3615FT	15 x 36 x 40.5	100	150	16.50	\$1033	n/a

Designed to be placed on top of credenzas. Laminate doors are standard, with two 3-position fixed/adjustable shelves. Handles are standard. Standard with locks. Unit rests directly on credenza top.

- Sxx15FT/FTL/FTR Stack-On storage cabinets add 3 tiers when placed on any storage unit.

S2415FNL	15 x 24 x 40.5	100	107	11.25	\$732	n/a
S3015FNL	15 x 30 x 40.5	100	121	14	\$801	n/a
S3615FNL	15 x 36 x 40.5	100	137	16.50	\$894	n/a
S4215FNL	15 x 42 x 40.5	100	171	19	\$1144	n/a

S2415FNR	15 x 24 x 40.5	100	107	11.25	\$732	n/a
S3015FNR	15 x 30 x 40.5	100	121	14	\$801	n/a
S3615FNR	15 x 36 x 40.5	100	137	16.50	\$894	n/a
S4215FNR	15 x 42 x 40.5	100	171	19	\$1144	n/a

Designed to be placed on top of credenzas. Laminate doors are standard on one side, with two 3-position fixed/adjustable shelves. Open cavities on the other side, with two 3-position fixed/adjustable shelves. Specify left or right handed. Handles are standard. Standard with locks. Unit rests directly on credenza top.

- Sxx15FNL/FNR Stack-On mixed storage cabinets add 3 tiers when placed on any storage unit.

S1224FTL	24 x 12 x 40.5	100	83	9.50	\$598	n/a
S1224FTR	24 x 12 x 40.5	100	83	9.50	\$598	n/a

Designed to be placed on top of credenzas. Laminate doors are standard. Includes hanging rod. Specify left or right handed. Handles are standard. Standard with locks. Unit rests directly on credenza top.

- S1224FTL/FTR Stack-On wardrobe cabinets add 3 tiers when placed on any storage unit.

Required Specifications

Top finish
Top/edge detail
Base finish
Door/Drawer Front Finish (Storage Cabinets only)

Handles (Storage Cabinets only)

STACK-ON STORAGE

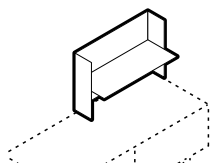

Stack-On Open Shelf - Single Sided

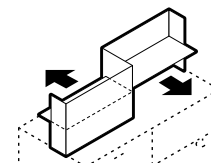

Stack-On Open Shelf - Back to Back

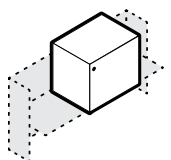

16.4-22.4" w (left)

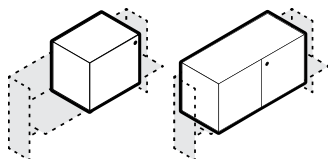

16.4-22.4" w (right)

27.9" - 33.9" w

Stack-On Closed Shelf Add-On Storage

MODEL#	DIMENSIONS D x W x H	FREIGHT CLASS	WT/LBS.	CUBIC FT.	LIST PRICE	HP ADD
S3013BH	13.2 x 30 x 20.25	85	33	2.75	\$301	n/a
S3613BH	13.2 x 36 x 20.25	92.5	38	3.25	\$329	n/a
S4213BH	13.2 x 42 x 20.25	85	43	3.50	\$357	n/a
S4813BH	13.2 x 48 x 20.25	85	48	4	\$385	n/a

Credenza mounted open shelf. Unit rests directly on credenza top.

- Accepts **OPEN SHELF ADD-ON STORAGE**
- Sxx13BH Stack-On open shelves add 1.5 tiers when placed on any storage unit.

S3614BH2	14 x 36 x 20.25	150	45	8	\$352	n/a
S4214BH2	14 x 42 x 20.25	150	51	9	\$380	n/a
S4814BH2	14 x 48 x 20.25	150	56	10.50	\$399	n/a
S6014BH2	14 x 60 x 20.25	150	65	12.75	\$450	n/a
S7214BH2	14 x 72 x 20.25	150	75	15.25	\$505	n/a

Credenza mounted open shelf. For use with back-to-back shared credenzas. Unit rests directly on credenza top.

- Accepts **OPEN SHELF ADD-ON STORAGE**
- Sxx14BH2 Stack-On open shelves add 1.5 tiers when placed on any storage unit.

S1613AHL	13.2 x 16.4 x 14.76	100	26	2.90	\$255	n/a
S1913AHL	13.2 x 19.4 x 14.76	100	29	3.40	\$264	n/a
S2213AHL	13.2 x 22.4 x 14.76	125	32	4.10	\$288	n/a

S1613AHR	13.2 x 16.4 x 14.76	100	26	2.90	\$255	n/a
S1913AHR	13.2 x 19.4 x 14.76	100	29	3.40	\$264	n/a
S2213AHR	13.2 x 22.4 x 14.76	125	32	4.10	\$288	n/a

S2813AH	13.2 x 27.9 x 14.76	100	41	4.70	\$399	n/a
S3413AH	13.2 x 33.9 x 14.76	100	46	5.70	\$436	n/a

Add-on storage must be affixed to open shelf credenza hutches. For 16", 19" and 22" w units, specify left or right handed.

Unit is NOT freestanding.

- Sxx13AH/AHL/AHR add-on storage adds 1 tier when placed on stack-on open shelves.

HUTCHES

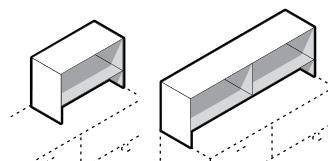

30" - 48" w

60" - 84" w

Low Hutch, Open

S3014BHO	14.3 x 30 x 20.25	125	55	7.25	\$334	n/a
S3614BHO	14.3 x 36 x 20.25	125	62	8.50	\$389	n/a
S4214BHO	14.3 x 42 x 20.25	125	69	10	\$426	n/a
S4814BHO	14.3 x 48 x 20.25	125	76	11.50	\$463	n/a
S6014BHO	14.3 x 60 x 20.25	125	95	14	\$570	n/a
S7214BHO	14.3 x 72 x 20.25	125	110	16.75	\$649	n/a
S8414BHO	14.3 x 84 x 20.25	125	124	19.50	\$723	n/a

Credenza mounted open hutch. Unit rests directly on credenza top.

- Sxx14BHO low hutches add 1.5 tiers when placed on any storage unit.

Required Specifications

Top finish
 Top/edge detail
 Base finish
 Door / Drawer Front Finish

Lock Finish (Add-On Storage only)

HUTCHES

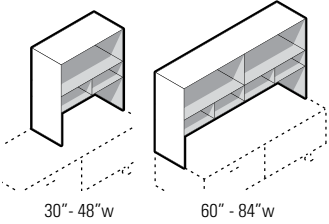

High Hutch, Open w/Pigeon Hole

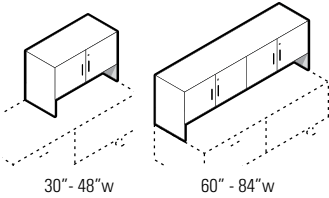

Low Hutch, Closed

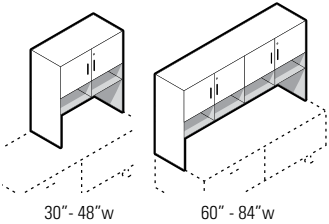

High Hutch, Closed w/Pigeon Hole

MODEL#	DIMENSIONS D x W x H	FREIGHT CLASS	WT/LBS.	CUBIC FT.	LIST PRICE	HP ADD
S3014EHO	14.3 x 30 x 33.75	125	85	11.50	\$547	n/a
S3614EHO	14.3 x 36 x 33.75	125	96	13.75	\$602	n/a
S4214EHO	14.3 x 42 x 33.75	125	107	16	\$658	n/a
S4814EHO	14.3 x 48 x 33.75	125	118	18	\$713	n/a
S6014EHO	14.3 x 60 x 33.75	125	148	22.25	\$908	n/a
S7214EHO	14.3 x 72 x 33.75	125	170	26.50	\$1019	n/a
S8414EHO	14.3 x 84 x 33.75	125	192	31	\$1130	n/a

Credenza mounted open hutch with pigeon hole storage. Unit rests directly on credenza top.

- Sxx14EHO high hutches add 2.5 tiers when placed on any storage unit.

S3015BHT	15 x 30 x 20.25	100	63	7.25	\$436	n/a
S3615BHT	15 x 36 x 20.25	100	71	8.50	\$500	n/a
S4215BHT	15 x 42 x 20.25	100	81	10	\$556	n/a
S4815BHT	15 x 48 x 20.25	125	89	11.50	\$593	n/a
S6015BHT	15 x 60 x 20.25	100	112	14	\$774	n/a
S7215BHT	15 x 72 x 20.25	125	130	16.75	\$875	n/a
S8415BHT	15 x 84 x 20.25	125	130	16.75	\$973	n/a

Credenza mounted closed hutch. Handles are standard. Standard with locks. Unit rests directly on credenza top.

- Sxx15BHT low hutches add 1.5 tiers when placed on any storage unit.

S3015EHT	15 x 30 x 33.75	100	93	11.50	\$644	n/a
S3615EHT	15 x 36 x 33.75	125	105	13.75	\$713	n/a
S4215EHT	15 x 42 x 33.75	125	118	16	\$788	n/a
S4815EHT	15 x 48 x 33.75	125	131	18	\$843	n/a
S6015EHT	15 x 60 x 33.75	125	165	22.25	\$1107	n/a
S7215EHT	15 x 72 x 33.75	125	190	26.50	\$1246	n/a
S8415EHT	15 x 84 x 33.75	125	215	31	\$1385	n/a

Credenza mounted closed hutch with pigeon hole storage. Handles are standard. Standard with locks. Unit rests directly on credenza top.

- Sxx15EHT high hutches add 2.5 tiers when placed on any storage unit.

Required Specifications

Top finish
 Top/edge detail
 Base finish
 Door / Drawer Front Finish

Handles

CUSHIONS

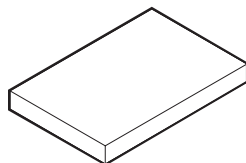

Cushion for Mobile Pedestals

MODEL#	DIMENSIONS	FREIGHT CLASS	WT/LBS.	CUBIC FT.	GRADE	LIST	GRADE	LIST
D x W x H								
CU1517	17 x 15 x 2.5	125	6	.90	1	\$95	7	\$275
					2	\$121	8	\$337
					3	\$141	9	\$385
					4	\$172	10	\$439
					5	\$215	11	\$549
					6	\$235	12	\$667
CU1520	20 x 15 x 2.5	70	1	1	1	\$102	7	\$282
					2	\$128	8	\$344
					3	\$148	9	\$392
					4	\$179	10	\$446
					5	\$222	11	\$556
					6	\$242	12	\$674
Cushion attaches with Velcro strips.								
• CU1517 for use on S1619MP. CU1520 for use on S1623MP.								
CU3020	20 x 30 x 2.5	150	6	1.30	1	\$153	7	\$333
					2	\$179	8	\$395
					3	\$199	9	\$443
					4	\$230	10	\$497
					5	\$273	11	\$607
					6	\$293	12	\$725
CU3620	20 x 36 x 2.5	150	7	1.60	1	\$172	7	\$352
					2	\$198	8	\$414
					3	\$218	9	\$462
					4	\$249	10	\$516
					5	\$292	11	\$626
					6	\$312	12	\$744
CU4220	20 x 42 x 2.5	70	1	1	1	\$195	7	\$375
					2	\$221	8	\$437
					3	\$241	9	\$485
					4	\$272	10	\$539
					5	\$315	11	\$649
					6	\$335	12	\$767
CU4820	20 x 48 x 2.5	70	1	1	1	\$213	7	\$527
					2	\$258	8	\$636
					3	\$294	9	\$721
					4	\$347	10	\$814
					5	\$423	11	\$1007
					6	\$458	12	\$1213
CU6020	20 x 60 x 2.5	70	1	1	1	\$297	7	\$611
					2	\$342	8	\$720
					3	\$378	9	\$805
					4	\$431	10	\$898
					5	\$507	11	\$1091
					6	\$542	12	\$1297
CU7220	20 x 72 x 2.5	70	1	1	1	\$351	7	\$665
					2	\$396	8	\$774
					3	\$432	9	\$859
					4	\$485	10	\$952
					5	\$561	11	\$1145
					6	\$596	12	\$1351

Required Specifications

Fabric

CUSHIONS

MODEL#	DIMENSIONS	FREIGHT CLASS	WT/LBS.	CUBIC FT.	GRADE	LIST	GRADE	LIST
	D x W x H							
CU8420	20 x 84 x 2.5	70	1	1	1	\$380	7	\$694
					2	\$425	8	\$803
					3	\$461	9	\$887
					4	\$514	10	\$981
					5	\$590	11	\$1174
					6	\$625	12	\$1380
CU3024	24 x 30 x 2.5	70	1	1	1	\$169	7	\$393
					2	\$201	8	\$471
					3	\$227	9	\$532
					4	\$265	10	\$599
					5	\$319	11	\$736
					6	\$344	12	\$883
CU3624	24 x 36 x 2.5	70	1	1	1	\$197	7	\$421
					2	\$229	8	\$499
					3	\$255	9	\$560
					4	\$293	10	\$627
					5	\$347	11	\$764
					6	\$372	12	\$911
CU4224	24 x 42 x 2.5	70	1	1	1	\$216	7	\$440
					2	\$248	8	\$518
					3	\$274	9	\$579
					4	\$312	10	\$646
					5	\$366	11	\$783
					6	\$391	12	\$930
CU4824	24 x 48 x 2.5	70	1	1	1	\$233	7	\$592
					2	\$284	8	\$717
					3	\$325	9	\$813
					4	\$386	10	\$920
					5	\$472	11	\$1141
					6	\$513	12	\$1376
CU6024	24 x 60 x 2.5	70	1	1	1	\$351	7	\$710
					2	\$402	8	\$835
					3	\$443	9	\$931
					4	\$504	10	\$1038
					5	\$591	11	\$1259
					6	\$631	12	\$1494
CU7224	24 x 72 x 2.5	70	1	1	1	\$382	7	\$741
					2	\$433	8	\$866
					3	\$474	9	\$962
					4	\$535	10	\$1069
					5	\$622	11	\$1290
					6	\$662	12	\$1525
CU8424	24 x 84 x 2.5	70	1	1	1	\$401	7	\$760
					2	\$452	8	\$885
					3	\$493	9	\$981
					4	\$554	10	\$1088
					5	\$640	11	\$1309
					6	\$681	12	\$1544

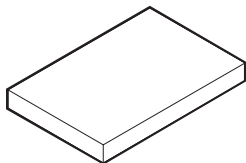

Cushion for Low Storage Cabinets

Cushion attaches with Velcro strips. For use on cabinets of coordinating size..

Required Specifications
Fabric

CUSHIONS

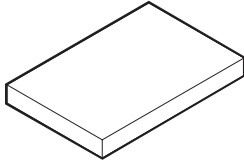

Cushion for Low Storage Cabinets

MODEL#	DIMENSIONS	FREIGHT CLASS	WT./LBS.	CUBIC FT.	GRADE	LIST	GRADE	LIST
D x W x H								
CU3037	30 x 37 x 2.5	70	1	1	1	\$242	7	\$511
					2	\$281	8	\$605
					3	\$311	9	\$677
					4	\$357	10	\$757
					5	\$422	11	\$923
					6	\$452	12	\$1099
CU3637	36 x 37 x 2.5	70	1	1	1	\$306	7	\$575
					2	\$345	8	\$669
					3	\$375	9	\$741
					4	\$421	10	\$821
					5	\$486	11	\$987
					6	\$516	12	\$1163

Cushion attaches with Velcro strips. For use on back-to-back low, deep credenzas.

Required Specifications

Fabric

TACKBOARDS

MODEL# DIMENSIONS FREIGHT CLASS WT/LBS. CUBIC FT. FABRIC GRD. LIST PRICE

D x W x H

TACKBOARD Notes: Tackboards can be upholstered in all of the following fabrics:

Grade 1: Agate II, Drama, Jenny, Pebbles, Quilt, Sprinkle, Station, Urban

Grade 2: Couture, Crescent, Cumulus, Imprint, Lola, Match, Oxygen, Quantum, Renewal, Replay, Silhouette

Grade 3: Brinx, Mariposa

Grade 4: Accent

Grade 5: Meander, Tracery, Universe

TACKBOARDS FOR DIVIDERS - SxxFUL9

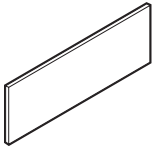

Tackboard for Dividers

STB4206	.62 x 42 x 6.5	150	2.28	.43	1	\$284
					2	\$305
					3	\$344
					4	\$374
					5	\$420

For use with **S42FUL9** divider. Covers entire side of divider. Velcro included for attachment.

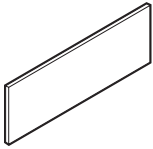

Tackboard for Dividers

STB4806	.62 x 48 x 6.5	150	2.60	.49	1	\$305
					2	\$326
					3	\$365
					4	\$395
					5	\$441

For use with **S48FUL9** divider. Covers entire side of divider. Velcro included for attachment.

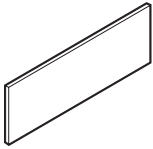

Tackboard for Dividers

STB6006	.62 x 60 x 6.5	150	3.25	.61	1	\$380
					2	\$408
					3	\$459
					4	\$500
					5	\$561

For use with **S60FUL9** divider. Covers entire side of divider. Velcro included for attachment.

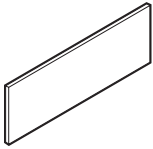

Tackboard for Dividers

STB7206	.62 x 72 x 6.5	150	3.90	.73	1	\$440
					2	\$472
					3	\$529
					4	\$575
					5	\$643

For use with **S72FUL9** divider. Covers entire side of divider. Velcro included for attachment.

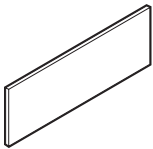

Tackboard for Dividers

STB8406	.62 x 84 x 6.5	150	4.55	.85	1	\$518
					2	\$553
					3	\$617
					4	\$668
					5	\$744

For use with **S84FUL9** divider. Covers entire side of divider. Velcro included for attachment.

Required Specifications

Fabric

TACKBOARDS FOR DIVIDERS - SxxFUL16

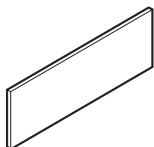

Tackboard for Dividers

MODEL#	DIMENSIONS D x W x H	FREIGHT CLASS	WT/LBS.	CUBIC FT.	FABRIC GRD.	LIST PRICE
STB4213	.62 x 42 x 13.25	150	4.64	.78	1	\$312
					2	\$333
					3	\$372
					4	\$402
					5	\$448

For use with **S42FUL16** divider. Covers entire side of divider. Velcro included for attachment.

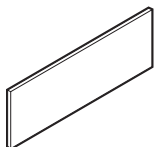

Tackboard for Dividers

STB4813	.62 x 48 x 13.25	125	5.30	.88	1	\$334
					2	\$355
					3	\$394
					4	\$424
					5	\$470

For use with **S48FUL16** divider. Covers entire side of divider. Velcro included for attachment.

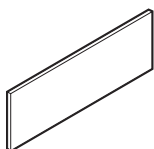

Tackboard for Dividers

STB6013	.62 x 60 x 13.25	125	6.63	1.09	1	\$418
					2	\$446
					3	\$497
					4	\$538
					5	\$599

For use with **S60FUL16** divider. Covers entire side of divider. Velcro included for attachment.

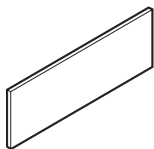

Tackboard for Dividers

STB7213	.62 x 72 x 13.25	125	7.95	1.31	1	\$482
					2	\$514
					3	\$571
					4	\$617
					5	\$685

For use with **S72FUL16** divider. Covers entire side of divider. Velcro included for attachment.

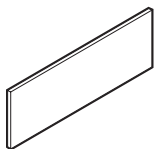

Tackboard for Dividers

STB8413	.62 x 84 x 13.25	125	9.28	1.52	1	\$564
					2	\$599
					3	\$663
					4	\$714
					5	\$790

For use with **S84FUL16** divider. Covers entire side of divider. Velcro included for attachment.

TACKBOARDS FOR DIVIDERS - SxxPAR9

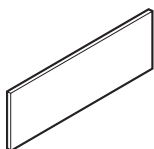

Tackboard for Dividers

STB2206	.62 x 22 x 6.5	70	1.19	.24	1	\$192
					2	\$206
					3	\$232
					4	\$252
					5	\$283

For use with **S42PAR9** divider. Covers entire side of divider. Velcro included for attachment.

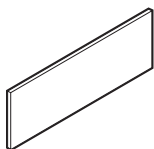

Tackboard for Dividers

STB2806	.62 x 28 x 6.5	70	1.52	.30	1	\$212
					2	\$226
					3	\$252
					4	\$272
					5	\$303

For use with **S48PAR9** divider. Covers entire side of divider. Velcro included for attachment.

Required Specifications

Fabric

S SIDEBAR

TACKBOARDS FOR DIVIDERS - SxxPAR9

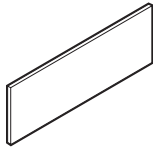

Tackboard for Dividers

MODEL#	DIMENSIONS D x W x H	FREIGHT CLASS	WT/LBS.	CUBIC FT.	FABRIC GRD.	LIST PRICE
STB4006	.62 x 40 x 6.5	150	2.17	.41	1	\$254
					2	\$275
					3	\$314
					4	\$344
					5	\$390

For use with **S60PAR9** divider. Covers entire side of divider. Velcro included for attachment.

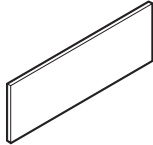

Tackboard for Dividers

STB5206	.62 x 52 x 6.5	150	2.82	.53	1	\$329
					2	\$354
					3	\$398
					4	\$434
					5	\$487

For use with **S72PAR9** divider. Covers entire side of divider. Velcro included for attachment.

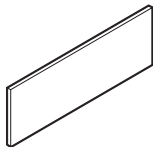

Tackboard for Dividers

STB6406	.62 x 64 x 6.5	150	3.47	.65	1	\$394
					2	\$422
					3	\$473
					4	\$514
					5	\$575

For use with **S84PAR9** divider. Covers entire side of divider. Velcro included for attachment.

TACKBOARDS FOR DIVIDERS - SxxPAR16

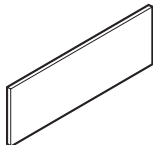

Tackboard for Dividers

STB2213	.62 x 22 x 13.25	150	2.43	.41	1	\$208
					2	\$219
					3	\$238
					4	\$253
					5	\$276

For use with **S42PAR16** divider. Covers entire side of divider. Velcro included for attachment.

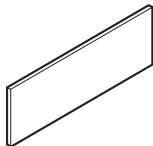

Tackboard for Dividers

STB2813	.62 x 28 x 13.25	150	3.09	.53	1	\$231
					2	\$245
					3	\$271
					4	\$291
					5	\$322

For use with **S48PAR16** divider. Covers entire side of divider. Velcro included for attachment.

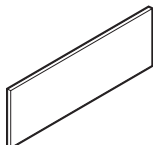

Tackboard for Dividers

STB4013	.62 x 40 x 13.25	150	4.42	.74	1	\$276
					2	\$297
					3	\$336
					4	\$366
					5	\$412

For use with **S60PAR16** divider. Covers entire side of divider. Velcro included for attachment.

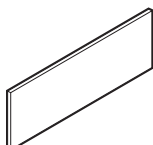

Tackboard for Dividers

STB5213	.62 x 52 x 13.25	125	5.74	.95	1	\$360
					2	\$385
					3	\$429
					4	\$465
					5	\$518

For use with **S72PAR16** divider. Covers entire side of divider. Velcro included for attachment.

Required Specifications

Fabric

TACKBOARDS FOR DIVIDERS - SxxPAR16

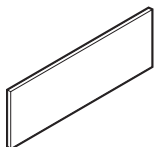

Tackboard for Dividers

MODEL#	DIMENSIONS D x W x H	FREIGHT CLASS	WT/LBS.	CUBIC FT.	FABRIC GRD.	LIST PRICE
STB6413	.62 x 64 x 13.25	125	7.07	1.16	1	\$433
					2	\$461
					3	\$512
					4	\$553
					5	\$614

For use with **S84PAR16** divider. Covers entire side of divider. Velcro included for attachment.

PARTIAL TACKBOARDS FOR DIVIDERS - SxxFUL9

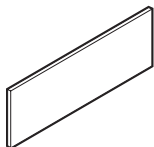

Tackboard for Dividers

STB2106	.62 x 21 x 6.5	70	1.14	.23	1	\$188
					2	\$199
					3	\$218
					4	\$233
					5	\$256

For use with **S42FUL9** divider. Covers **half** of divider. Velcro included for attachment.

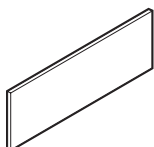

Tackboard for Dividers

STB2406	.62 x 24 x 6.5	70	1.30	.26	1	\$198
					2	\$212
					3	\$238
					4	\$258
					5	\$289

For use with **S48FUL9** divider. Covers **half** of divider. Velcro included for attachment.

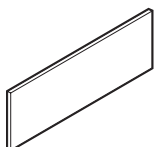

Tackboard for Dividers

STB3006	.62 x 30 x 6.5	70	1.63	.31	1	\$219
					2	\$233
					3	\$259
					4	\$279
					5	\$310

For use with **S60FUL9** divider. Covers **half** of divider. Velcro included for attachment.

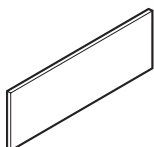

Tackboard for Dividers

STB3606	.62 x 36 x 6.5	70	1.95	.37	1	\$240
					2	\$258
					3	\$290
					4	\$315
					5	\$353

For use with **S72FUL9** divider. Covers **half** of divider. Velcro included for attachment.

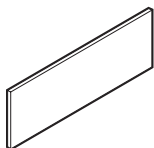

Tackboard for Dividers

STB4206	.62 x 42 x 6.5	150	2.28	.43	1	\$284
					2	\$305
					3	\$344
					4	\$374
					5	\$420

For use with **S84FUL9** divider. Covers **half** of divider. Velcro included for attachment.

Required Specifications

Fabric

S SIDEBAR

PARTIAL TACKBOARDS FOR DIVIDERS - SxxFUL16

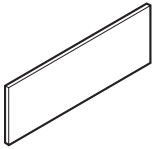

Tackboard for Dividers

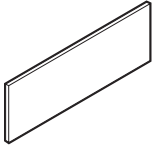

Tackboard for Dividers

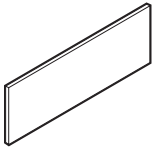

Tackboard for Dividers

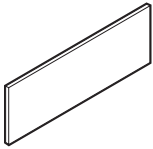

Tackboard for Dividers

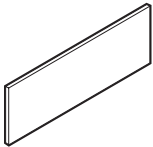

Tackboard for Dividers

MODEL#	DIMENSIONS	FREIGHT CLASS	WT/LBS.	CUBIC FT.	FABRIC GRD.	LIST PRICE
--------	------------	---------------	---------	-----------	-------------	------------

	D x W x H					
STB2113	.62 x 21 x 13.25	150	2.32	.41	1	\$204
					2	\$215
					3	\$234
					4	\$249
					5	\$272

For use with **S42FUL16** divider. Covers **half** of divider. Velcro included for attachment.

STB2413	.62 x 24 x 13.25	250	2.65	.78	1	\$216
					2	\$230
					3	\$256
					4	\$276
					5	\$307

For use with **S48FUL16** divider. Covers **half** of divider. Velcro included for attachment.

STB3013	.62 x 30 x 13.25	150	3.31	.56	1	\$238
					2	\$252
					3	\$278
					4	\$298
					5	\$329

For use with **S60FUL16** divider. Covers **half** of divider. Velcro included for attachment.

STB3613	.62 x 36 x 13.25	150	3.98	.67	1	\$261
					2	\$279
					3	\$311
					4	\$336
					5	\$374

For use with **S72FUL16** divider. Covers **half** of divider. Velcro included for attachment.

STB4213	.62 x 42 x 13.25	150	4.64	.78	1	\$312
					2	\$333
					3	\$372
					4	\$402
					5	\$448

For use with **S84FUL16** divider. Covers **half** of divider. Velcro included for attachment.

PARTIAL TACKBOARDS FOR DIVIDERS - SxxPAR9

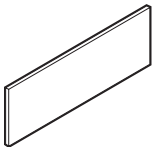

Tackboard for Dividers

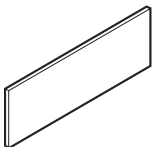

Tackboard for Dividers

STB1106	.62 x 11 x 6.5	70	.60	.13	1	\$153
					2	\$160
					3	\$173
					4	\$183
					5	\$199

For use with **S42PAR9** divider. Covers **half** of divider. Velcro included for attachment.

STB1406	.62 x 14 x 6.5	70	.76	.16	1	\$164
					2	\$175
					3	\$194
					4	\$209
					5	\$232

For use with **S48PAR9** divider. Covers **half** of divider. Velcro included for attachment.

Required Specifications

Fabric

PARTIAL TACKBOARDS FOR DIVIDERS - SxxPAR9

MODEL# DIMENSIONS FREIGHT CLASS WT/LBS. CUBIC FT. FABRIC GRD. LIST PRICE

D x W x H

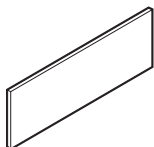

Tackboard for Dividers

STB2006	.62 x 20 x 6.5	70	1.08	.22	1	\$185
					2	\$196
					3	\$215
					4	\$230
					5	\$253

For use with **S60PAR9** divider. Covers **half** of divider. Velcro included for attachment.

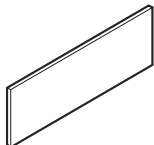

Tackboard for Dividers

STB2606	.62 x 26 x 6.5	70	1.41	.28	1	\$205
					2	\$219
					3	\$245
					4	\$265
					5	\$296

For use with **S72PAR9** divider. Covers **half** of divider. Velcro included for attachment.

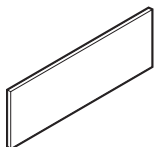

Tackboard for Dividers

STB3206	.62 x 32 x 6.5	70	1.73	.33	1	\$226
					2	\$244
					3	\$276
					4	\$301
					5	\$339

For use with **S84PAR9** divider. Covers **half** of divider. Velcro included for attachment.

PARTIAL TACKBOARDS FOR DIVIDERS - SxxPAR16

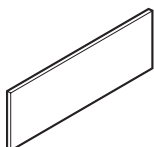

Tackboard for Dividers

STB1113	.62 x 11 x 13.25	70	1.21	.23	1	\$166
					2	\$173
					3	\$186
					4	\$196
					5	\$212

For use with **S42PAR16** divider. Covers **half** of divider. Velcro included for attachment.

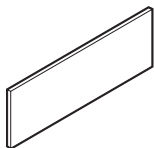

Tackboard for Dividers

STB1413	.62 x 14 x 13.25	70	1.55	.28	1	\$178
					2	\$189
					3	\$208
					4	\$223
					5	\$246

For use with **S48PAR16** divider. Covers **half** of divider. Velcro included for attachment.

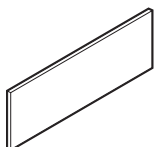

Tackboard for Dividers

STB2013	.62 x 20 x 13.25	150	2.21	.39	1	\$200
					2	\$211
					3	\$230
					4	\$245
					5	\$268

For use with **S60PAR16** divider. Covers **half** of divider. Velcro included for attachment.

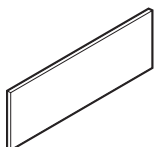

Tackboard for Dividers

STB2613	.62 x 26 x 13.25	150	2.87	.49	1	\$223
					2	\$237
					3	\$263
					4	\$283
					5	\$314

For use with **S72PAR16** divider. Covers **half** of divider. Velcro included for attachment.

Required Specifications

Fabric

S SIDEBAR

PARTIAL TACKBOARDS FOR DIVIDERS - SxxPAR16

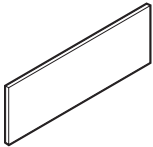

Tackboard for Dividers

MODEL#	DIMENSIONS D x W x H	FREIGHT CLASS	WT./LBS.	CUBIC FT.	FABRIC GRD.	LIST PRICE
STB3213	.62 x 32 x 13.25	150	3.53	.60	1	\$246
					2	\$264
					3	\$296
					4	\$321
					5	\$359

For use with **S84PAR16** divider. Covers **half** of divider. Velcro included for attachment.

TACKBOARDS FOR TRANSACTION TOP FILLERS

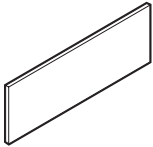

Tackboard for Transaction Top Filler

STB2306	.62 x 22.25 x 6.5	70	1.21	.24	1	\$192
					2	\$206
					3	\$232
					4	\$252
					5	\$283

For use with **S3612T9** transaction top filler. Covers entire area below transaction top. Velcro included for attachment.

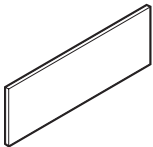

Tackboard for Transaction Top Filler

STB2313	.62 x 23 x 13.25	150	2.54	.44	1	\$212
					2	\$226
					3	\$252
					4	\$272
					5	\$303

For use with **S3612T16** transaction top filler. Covers entire area below transaction top. Velcro included for attachment.

TACKBOARDS FOR SHARED DIVIDER STORAGE FILLERS

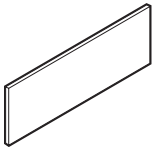

Tackboard for Shared Storage Filler

STB2306	.62 x 22.25 x 6.5	70	1.21	.24	1	\$192
					2	\$206
					3	\$232
					4	\$252
					5	\$283

Velcro included for attachment.

- Use with **S4813PCL/S4813POL** shared divider storage filler. Covers entire area below storage.
- Use with **S4813PCH/S4813POH** shared divider storage filler. Covers entire area below storage.
- Use with **S4212GL** shared pigeon hole storage filler. Covers entire area below pigeon hole storage.

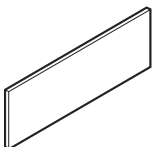

Tackboard for Shared Storage Filler

STB2313	.62 x 23 x 13.25	150	2.54	.44	1	\$212
					2	\$226
					3	\$252
					4	\$272
					5	\$303

Velcro included for attachment.

- Use with **S4813PCL/S4813POL** shared divider storage filler. Covers entire area on the back of the storage upper.
- Use with **S4813PCH/S4813POH** shared divider storage filler. Covers entire area on the back of the storage upper.
- Use with **S4212GH** shared pigeon hole storage filler. Covers entire area below pigeon hole storage.

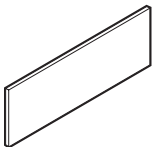

Tackboard for Shared Divider Storage Filler

STB1113	.62 x 11 x 13.25	70	1.21	.23	1	\$166
					2	\$173
					3	\$186
					4	\$186
					5	\$196

For use with **S4813PCL/S4813POL** shared divider storage filler. Covers small area on the back of the storage upper. Velcro included for attachment.

Also for use with **S4813PCH/S4813POH** shared divider storage filler. Covers small area on the back of the storage upper

Required Specifications

Fabric

TACKBOARDS FOR STACK-ON OPEN SHELVES

MODEL# DIMENSIONS FREIGHT CLASS WT/LBS. CUBIC FT. FABRIC GRD. LIST PRICE

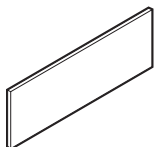

Tackboard for Stack-On Open Shelf

D x W x H						
STB3020	.62 x 30 x 20	125	5	.81	1	\$257
					2	\$271
					3	\$297
					4	\$317
					5	\$348

For use with **S3013BH** stack-on open shelf. Covers entire back panel. Velcro included for attachment.

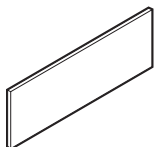

Tackboard for Stack-On Open Shelf

STB3620	.62 x 36 x 20	125	6	.97	1	\$282
					2	\$300
					3	\$332
					4	\$357
					5	\$395

For use with **S3613BH** stack-on open shelf. Covers entire back panel. Velcro included for attachment.

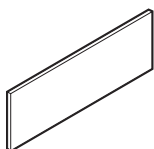

Tackboard for Stack-On Open Shelf

STB4220	.62 x 42 x 20	125	7	1.12	1	\$321
					2	\$342
					3	\$381
					4	\$411
					5	\$457

For use with **S4213BH** stack-on open shelf. Covers entire back panel. Velcro included for attachment.

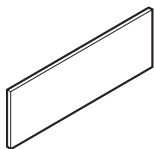

Tackboard for Stack-On Open Shelf

STB4820	.62 x 48 x 20	125	8	1.27	1	\$364
					2	\$385
					3	\$424
					4	\$454
					5	\$500

For use with **S4813BH** stack-on open shelf. Covers entire back panel. Velcro included for attachment.

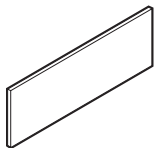

Tackboard for Stack-On Open Shelf

STB1820	.62 x 18 x 20	150	3	.51	1	\$208
					2	\$219
					3	\$238
					4	\$253
					5	\$276

For use with **S3614BH2** stack-on open shelf. Covers entire back panel. Velcro included for attachment.

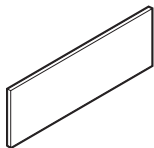

Tackboard for Stack-On Open Shelf

STB2120	.62 x 21 x 20	150	3.50	.59	1	\$220
					2	\$231
					3	\$250
					4	\$265
					5	\$288

For use with **S4214BH2** stack-on open shelf. Covers entire back panel. Velcro included for attachment.

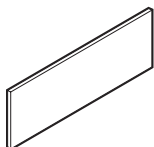

Tackboard for Stack-On Open Shelf

STB2420	.62 x 24 x 20	125	4	.66	1	\$233
					2	\$247
					3	\$273
					4	\$293
					5	\$324

For use with **S4814BH2** stack-on open shelf. Covers entire back panel. Velcro included for attachment.

Required Specifications

Fabric

S SIDEBAR

TACKBOARDS FOR STACK-ON OPEN SHELVES

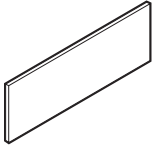

Tackboard for Stack-On Open Shelf

MODEL#	DIMENSIONS D x W x H	FREIGHT CLASS	WT./LBS.	CUBIC FT.	FABRIC GRD.	LIST PRICE
STB3020	.62 x 30 x 20	125	5	.81	1	\$257
					2	\$271
					3	\$297
					4	\$317
					5	\$348

For use with **S6014BH2** stack-on open shelf. Covers entire back panel. Velcro included for attachment.

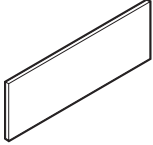

Tackboard for Stack-On Open Shelf

STB3620	.62 x 36 x 20	125	6	.97	1	\$282
					2	\$300
					3	\$332
					4	\$357
					5	\$395

For use with **S7214BH2** stack-on open shelf. Covers entire back panel. Velcro included for attachment.

TACKBOARDS FOR HUTCHES

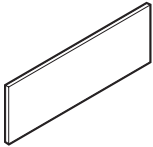

Tackboard for Hutches

STB2812	.62 x 28 x 12	150	2.80	.49	1	\$227
					2	\$241
					3	\$267
					4	\$287
					5	\$318

For use on **S3014EHO/S3015EHT** hutches. Velcro included for attachment.

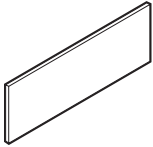

Tackboard for Hutches

STB3412	.62 x 34 x 12	150	3.40	.58	1	\$250
					2	\$268
					3	\$300
					4	\$325
					5	\$363

For use on **S3614EHO/S3615EHT** hutches. Velcro included for attachment.

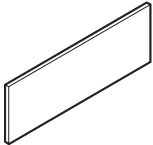

Tackboard for Hutches

STB4012	.62 x 40 x 12	150	4	.68	1	\$272
					2	\$293
					3	\$332
					4	\$362
					5	\$408

For use on **S4214EHO/S4215EHT** hutches. Velcro included for attachment.

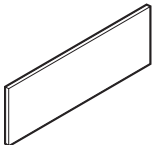

Tackboard for Hutches

STB4612	.62 x 46 x 12	150	4.60	.78	1	\$321
					2	\$342
					3	\$381
					4	\$411
					5	\$457

For use on **S4814EHO/S4815EHT** hutches. Velcro included for attachment.

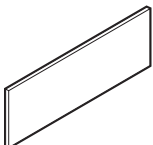

Tackboard for Hutches

STB5812	.62 x 58 x 12	150	5.80	.97	1	\$385
					2	\$413
					3	\$464
					4	\$505
					5	\$566

For use on **S6014EHO/S6015EHT** hutches. Velcro included for attachment.

Required Specifications

Fabric

TACKBOARDS FOR HUTCHES

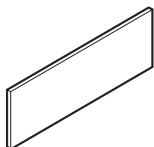

Tackboard for Hutches

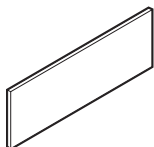

Tackboard for Hutches

MODEL# DIMENSIONS FREIGHT CLASS WT/LBS. CUBIC FT. FABRIC GRD. LIST PRICE

MODEL#	DIMENSIONS	FREIGHT CLASS	WT/LBS.	CUBIC FT.	FABRIC GRD.	LIST PRICE
STB7012	.62 x 70 x 12	150	7	1.17		
					D x W x H	
					1	\$448
					2	\$480
					3	\$537
4	\$583					
5	\$651					

For use on **S7214EHO/S7215EHT** hutches. Velcro included for attachment.

STB8212	.62 x 82 x 12	125	8.20	1.36		
					1	\$548
					2	\$583
					3	\$647
					4	\$698
5	\$774					

For use on **S8414EHO/S8415EHT** hutches. Velcro included for attachment.

Required Specifications

Fabric

POWER DELIVERY / CABLE MANAGEMENT

D x W x H

At the basic level, table and floor based office equipment is serviced by a wall or floor power supply. As the operation grows, there might be a need to organize excessive cable clutter.

(1) **Cable Snake JBPS** installed in proximity of floor monument to manage vertical cable clutter.

Table clamped, single circuit (2) **Desk Top Power Data Modules** deliver services to desk height, while tapping into wall or floor power supply. Excessive cables can be managed with (3) **Wire Management Clamps JBWM2**.

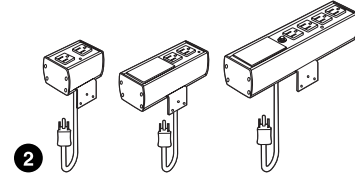

(4) **Below Worksurface Power/Data Troughs** can be installed between back-to-back tables for extended below desk height power/data distribution.

- 8 wire, 4-circuit system. (2 + 2 circuit configuration)

To specify electrical, utilize the following steps:

- For each back-to-back worksurface, specify (1) **SEDBKIT**
 - SEDBKIT is centered below the wire pass thru on the surface
 - Unlike other wiring systems, Sidebar's electrical can have individual simplex outlets on different circuits
- Specify a total of (4) simplex outlets per user - up to four different circuits can be specified for a single user
- Jumpers (SExxFFJ) will bring power from one SEDBKIT to another - subtract 6" from the worksurface length to calculate the necessary length jumper
- Currently, Sidebar can only accommodate basefeeds from a floor or wall
- Basefeeds (SEBFxx) are available in multiple lengths and can be positioned at the end of a run or the middle of a run
- Global recommends the use of a vertical cable manager (such as the JBPS or PCSN01) to manage the basefeed and data cable from floor or wall to the underside of a worksurface

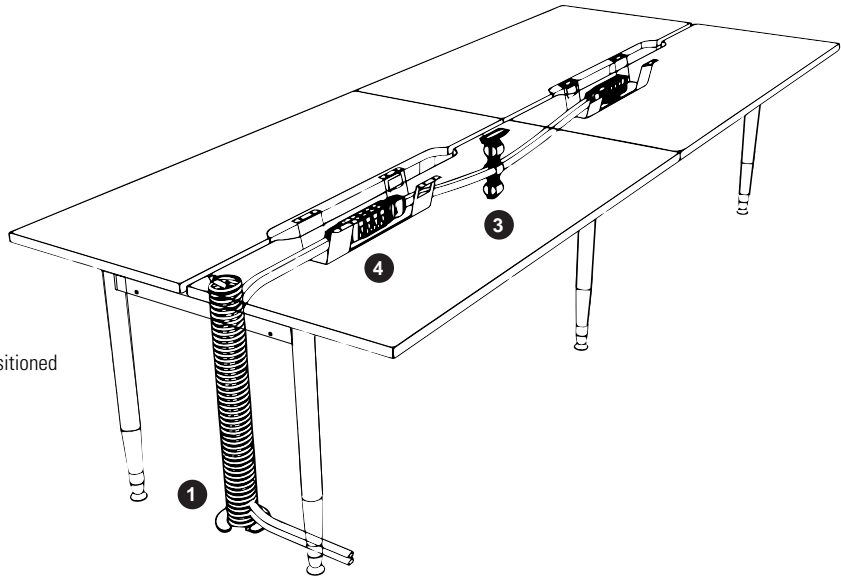

4-2-2 Wiring Schematic

8-Wire Shared Neutral

"2 + 2" - 2 Utility Circuits, 2 Dedicated

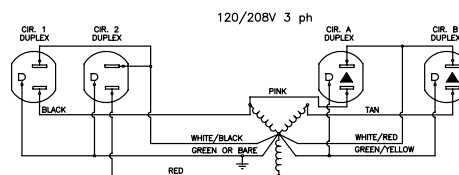
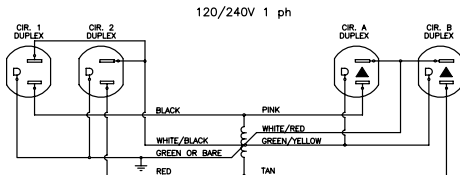

8 Wires

4 lines (12 ga.)
2 Neutrals (10 ga.)
2 Grounds (12 ga.)

4 Circuits

2 Utility circuits
2 Dedicated Circuits

Receptacles

Duplex - Up to 12 duplex receptacles per circuit
(Up to 48 per infeed)

Specifications

System rated for connection to a grounded 120/240 V single phase, 20A, 60Hz or 120/208 V, 3 phase, 20A, 60Hz branch circuit for U.S. and 15A if product is marked with a C-UL Mark. Outlets rated 15A max.

POWER DELIVERY / CABLE MANAGEMENT

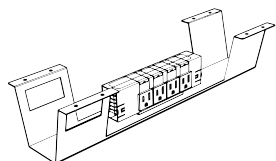

Below Worksurface Double Power/Data Trough

MODEL# DIMENSIONS FREIGHT CLASS WT/LBS. CUBIC FT. LIST PRICE

	D x W x H				
SEDBKIT	8 x 24 x 8	250	3	.80	\$255

Formed steel trough with double sided Power block is secured below worksurface, centered. Four simplex outlets can be specified on each side (sold separately). One trough size can be used on all worksurface sizes. Specify jumpers between tables separately. Base feed entry can be made at either end of trough. Each trough has one opening at 1.37" x 2.68" (one per side) for data/communication terminal plates. Specify Silver (SI) or Black (BK) finish.

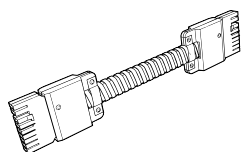

Jumper Cable

SE36FFJ	3 x 36 x 3	70	1.37	.50	\$104
SE39FFJ	3 x 39 x 3	70	1.52	.50	\$108
SE42FFJ	3 x 42 x 3	70	1.60	.50	\$111
SE45FFJ	3 x 45 x 3	70	1.75	.50	\$115
SE48FFJ	3 x 48 x 3	70	1.82	.50	\$118
SE51FFJ	3 x 51 x 3	70	1.98	.50	\$122
SE54FFJ	3 x 54 x 3	150	2.05	.50	\$125
SE57FFJ	3 x 57 x 3	150	2.20	.50	\$128
SE60FFJ	3 x 60 x 3	150	2.28	.50	\$132
SE63FFJ	3 x 63 x 3	150	2.43	.50	\$135
SE66FFJ	3 x 66 x 3	150	2.51	.50	\$139
SE69FFJ	3 x 69 x 3	150	2.66	.50	\$142
SE72FFJ	3 x 72 x 3	150	2.74	.50	\$146
SE75FFJ	3 x 75 x 3	150	2.89	.50	\$149
SE78FFJ	3 x 78 x 3	150	2.96	.50	\$153

Flexible metal conduit is used to distribute electrical power from one trough to another. To calculate the length needed between power troughs, take the measurement of the center of one trough to another and subtract 6".

Example: Two 72" workstations would necessitate a 66" jumper.

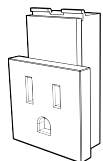

Simplex Receptacle

SE8R1	1 x 1.5 x 2	70	.04	.01	\$13
SE8R2	1 x 1.5 x 2	70	.04	.01	\$13
SE8RA	1 x 1.5 x 2	70	.04	.01	\$13
SE8RB	1 x 1.5 x 2	70	.04	.01	\$13

Snaps into Power block. Up to 13 duplex receptacles per circuit. Black finish for Circuits 1 and 2. Orange finish for Circuits A and B.

- SE8R1 - Circuit #1 (utility circuit)
- SE8R2 - Circuit #2 (utility circuit)
- SE8RA - Circuit A (dedicated circuit)
- SE8RB - Circuit B (dedicated circuit)

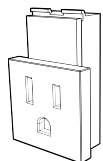

Controlled Circuit Simplex Receptacle

SE8R1CA	1 x 1.5 x 2	70	.04	.01	\$18
SE8R2CA	1 x 1.5 x 2	70	.04	.01	\$18
SE8RACA	1 x 1.5 x 2	70	.04	.01	\$18
SE8RBCA	1 x 1.5 x 2	70	.04	.01	\$18

Snaps into Power block. Up to 13 duplex receptacles per circuit. Black finish for Circuits 1 and 2. Orange finish for Circuits A and B. Meets California Title 24, Federal and LEED Certification.

- SE8R1CA - Circuit #1 (utility circuit)
- SE8R2CA - Circuit #2 (utility circuit)
- SE8RACA - Circuit A (dedicated circuit)
- SE8RBCA - Circuit B (dedicated circuit)

Required Specifications

Finish (SEDBKIT)

S SIDEBAR

POWER DELIVERY / CABLE MANAGEMENT

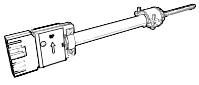

Base Feed

MODEL#	DIMENSIONS D x W x H	FREIGHT CLASS	WT./LBS.	CUBIC FT.	LIST PRICE
SEBF72	5 x 72 x 5	250	2.74	.80	\$135
SEBF120	5 x 120 x 5	150	4.56	.80	\$190
SEBF144	5 x 144 x 5	125	5.47	.80	\$218

Provides single power entry from floor or wall located building power supply. Connects to Power block. Must be hard wired to the building power supply by a licensed electrician.

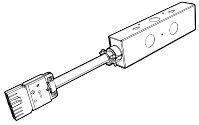

Base Feed - New York Electrical

SEBFNYC	5 x 120 x 5	125	5	.80	\$242
---------	-------------	-----	---	-----	--------------

Provides single power entry from floor or wall located building power supply. Connects to Power block. Must be hard wired to the building power supply by a licensed electrician.

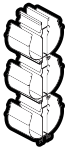

Wire Management Clamp

JBWM2	2.5 x 6 x 1.75	70	1	.01	\$117
-------	----------------	----	---	-----	--------------

Wire management track with double wire clamp - triple height. Can be affixed to the underside of worksurface using double-sided tape (supplied) or retrofit into power/data management trough modules. Black finish only.

- Recommended for use at 90° corners.
- Retrofitting requires disassembly of power/data management trough modules.

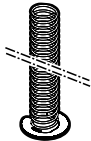

Power Snake

JBPS	4 x 4 x 34	100	2	.25	\$71
------	------------	-----	---	-----	-------------

Attaches to the underside of worksurface with supplied wood screws. Used to organize and channel wires from the power/data management trough down to the floor infeed. Black finish only.



Cable Snake

PCSN01	-- x -- x --	92.5	2.10	.20	\$96
--------	--------------	------	------	-----	-------------

Flexible cable management. Provides access to power/data from floor to underside of worksurface where it attaches. Two pathways within Cable Snake. Length under desk is 31.25". Silver (**SIL**) plastic only.

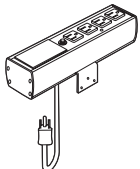

4 Outlet, 1 Telecom Blank Plate

PGDPS41	2.5 x 10.25 x 2.22	70	1.50	.02	\$183
---------	--------------------	----	------	-----	--------------

4 power receptacles and 1 telecom blank plate. Available for mounting behind pull-out shelf or open space credenza. Tungsten (TUN) finish. 12 foot black cord.

POWER DELIVERY / CABLE MANAGEMENT

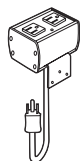

2 Outlet Power block

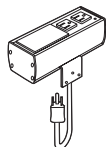

2 Outlet, 1 Telecom Blank Plate

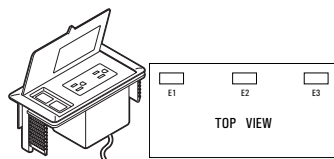

Power/Data Block

MODEL#	DIMENSIONS	FREIGHT CLASS	WT./LBS.	CUBIC FT.	LIST PRICE
--------	------------	---------------	----------	-----------	------------

D x W x H

PGDPS20	2.5 x 3.58 x 2.22	70	1	.01	\$131
---------	-------------------	----	---	-----	--------------

2 power receptacles. Available for side mounted installation. Tungsten (TUN) finish. 12 foot black cord.

PGDPS21	2.5 x 6.75 x 2.22	70	1.25	.01	\$169
---------	-------------------	----	------	-----	--------------

2 power receptacles and 1 telecom blank plate. Available for side mounted installation. Tungsten (TUN) finish. 12 foot black cord.

PMSPDM	3.5 x 6.5 x 2.75	70	2	.10	\$238
--------	------------------	----	---	-----	--------------

Worksurface power and data module. Two power receptacles and two data receptacles. Specify position and add **\$65.00** for cutout in worksurface. See diagram E1/E2/E3 for specification location. Black (**BLK**) only.

S SIDEBAR

VILLA I SERIES CORDED UNITS

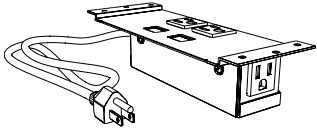

Data Knockouts, No Data Ports

MODEL#	DIMENSIONS D x W x H	FREIGHT CLASS	WT./LBS.	CUBIC FT.	LIST PRICE
VIL-C-DKO-_-108	10 x 11 x 7	100	4	.45	\$186
VIL-C-DKO-_-72	10 x 11 x 7	100	4	.45	\$186

Villa I with 3-prong plug. Includes **two power receptacles** and two knockouts for data. A third convenience receptacle is provided below the worksurface. **V1, V2 or V3 cutout(s) must be specified on training table** (see product notes section for more details and cutout upcharge). **Grommet cover is required and sold separate** (see next page). UL/CUL listed.

- Replace _ with **B** for **Black**
- Replace _ with **S** for **Silver Pearl**

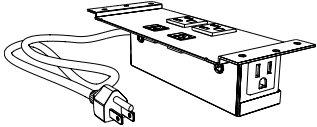

Data Knockouts, Data Ports Included

VIL-C-D-_-108	10 x 11 x 7	100	4	.45	\$301
VIL-C-D-_-72	10 x 11 x 7	100	4	.45	\$301

Villa I with 3-prong plug. Includes **two power receptacles** and **two RJ45 Cat 6** data. A third convenience receptacle is provided below the worksurface. **V1, V2 or V3 cutout(s) must be specified on training table** (see product notes section for more details and cutout upcharge). **Grommet cover is required and sold separate** (see next page). UL/CUL listed.

- Replace _ with **B** for **Black**
- Replace _ with **S** for **Silver Pearl**

VILLA GROMMET COVERS

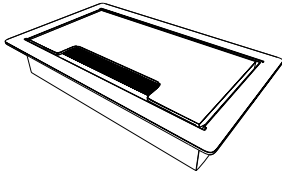

Villa Grommet Cover

VIL-GROM-F-_-	5 x 7 x 4	70	1	.08	\$93
---------------	-----------	----	---	-----	-------------

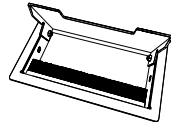

Powder coated flush metal grommet to be used with Villa I **corded** series Power blocks. Cutouts in tables must be specified separately. **V1, V2 or V3 cutout(s) must be specified on training table** (see product notes section for more details and cutout upcharge). **Grommet cover remains open while in use.**

- **Cannot be used with PMSPDM.**
- Replace _ with **B** for **Black**
- Replace _ with **S** for **Silver Pearl**

Required Specifications





Finish
Power Infeed
Cutout location

TOP TELECOM PLATES	MODEL	CONFIGURATION	LIST PRICE
	A-__-A-B	Telecom plate with RJ11 Cat 3 Phone and RJ45 Cat 6 Data	\$80
	A-__-B-B	(2) RJ45 Cat 6 Connectors	\$105
	A-__-B-B-B	(3) RJ45 Cat 6 Connectors	\$154
	A-__-B-B-B-B	(4) RJ45 Cat 6 Connectors	\$204
	A-__-B-C51-L	RJ45 Cat 6 Data, Mini-Stereo Inline and 15 pin HD VGA Female/Female with 72" patch cord attached.	\$182
	A-__-B-B-C51	(2) RJ45 Cat 6 Data and (1) 15 pin HD VGA Female/Female with 72" patch cord attached.	\$190
	A-__-A-B-102	RJ11 Cat 3 phone, RJ45 Cat 6 Data and USB with 72" patch cord attached.	\$182
	A-__-B	RJ45 Cat 6 Data	\$55
	A-__-C51-L	Mini Stereo Inline and 15 pin HD VGA Female/Female with 72" patch cord attached.	\$142
	A-__-CRDMINDER	Cordminder Plate - 2 5/8" holes and 1 7/8" holes	\$31
	A-__-C45-C51-L	HDMI Female/Female with 36" patch cord attached. Mini Stereo Inline and 15 Pin HD VGA Female/Female with 72" patch cord attached.	\$249

Required Specifications

- Finish
- Power Infeed
- Cutout location

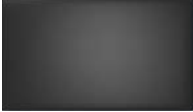
S SIDEBAR

TOP TELECOM PLATES	MODEL	CONFIGURATION	LIST PRICE
	A-__-C45	HDMI Female/Female with 36" patch cord attached.	\$122
	A-__-A-B-B	(1) RJ11 Cat 3 Phone and (2) RJ45 Cat 6 data.	\$133
	A-__	Blank telecom plate	\$6
	A-__-102	USB with 72" patch cord attached.	\$55
	A-__-C51	15 pin HD VGA Female/Female with 72" patch cord attached.	\$91

- Replace _ with **BL** for **Black**
- Replace _ with **GR** for **Grey**

Required Specifications

Finish
 Power Infeed
 Cutout location

panels and components



Divide

502-514



e0+

468-501



GPS II

515-522



eO+® is an innovative modular panel and desking system that works for you in a variety of ways. Create workstations, conference rooms and teaming areas with components that are easy to mix, match and reconfigure.

Panels can be freestanding or used with coordinating desking and storage components to provide varying degrees of privacy. Styles include full privacy, partial whiteboard, partially glazed and fully glazed.

Worksurfaces provide ergonomic access to computers and provide generous space for a multitude of daily tasks. Off desk accessories can be quickly and easily repositioned along the optional panel mounted rail. Electrical components are necessary for everyday use and include electrical and data receptacles that can be worksurface mounted.

eO+® is easy to use and move; its lightweight components fit together with convenience and ease. The eO+® system of office furniture adapts as fast as your needs change.



Features and Benefits

- Partially and Fully Glazed Panels are available in “Clear”, “Smoked” and “Frosted” options
- Partial Whiteboard Panels are available on one or two sides
- Primary worksurfaces are 18”, 24” or 30” deep, the optimum reach of an individual
- 3mm matching edge on all worksurfaces
- Worksurface scoops keep wires neat and out of the way
- Adapt Power/Data Module provides worksurface access to two electrical outlets and two plugs with adaptors.
- eO+’s pedestals can be worksurface-supporting or freestanding. Box drawers have one pencil tray and one plate divider. All drawers have steel ball-bearing suspensions and lock.
- Overhead Storage and Personal Towers add additional storage possibilities.
- Panel frames, legs and pedestals are available in Black and Tungsten 2.
- Accessories can attach to worksurfaces or panels using an accessory rail. Available in Black and Frosted on most models.



Partially glazed panels provide privacy and additional light



Electrical and data receptacles can be worksurface mounted

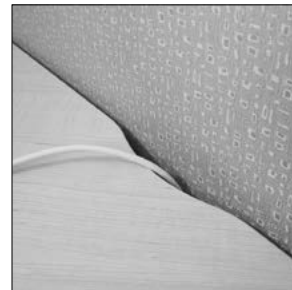

Worksurface scoops provide wire management

GENERAL INFORMATION

- Innovative Modular Panel and Desking system.
- Versatile design with economic and ergonomic advantages.
- Perfect for workstation, conference room and teaming areas.
- Simple, modular, mix-and-match components that are easy to specify and assemble.
- Worksurfaces are supported by steel pedestals, worksurface/panel supporting hardware and end panels.
- eO+'s load bearing panel frames accepts worksurfaces at 29"H in height. Off-Desk Accessory Bars are at 36" - 40"H and Open Shelves at 50"H. The top of the overhead storage cabinet can only be used on the 66"H Panel when the top of it is even with the top of the 66"H Panel.
- Islands and Spanner Islands are supported with square or tapered steel legs in conjunction with the above.
- Panels offer different degrees of privacy in a variety of styles.
- The entire eO+ panel is recyclable at the end of its life.
- All brackets and metal storage components consist of up to 30% recycled steel that can again be recycled.
- Durable epoxy powder coating used on all metal components contains no harmful VOC's or lead.
- Global laminate and seating products are in compliance with stringent emission guidelines set out by the Greenguard Environmental Institute under the standards for low emitting products and materials. www.greenguard.org
- **Level 2 Certified**

PRIVACY PANEL CONSTRUCTION

- Tackable substrate honeycomb core covered in fabric
- Panels are constructed of lightweight aluminum with a self levelling feature to maintain even height of all panels and permit fast installation and reconfiguration
- Honeycomb panel cores are made from 30% recycled card stock
- Slotted verticals provide load bearing capabilities
- Each panel comes with 2 ½" glides allowing for 2" height adjustment and two full length capture strips
- Patented "knuckle-loc" design ensures solid panel-to-panel connection
- Universal corner post (two-way, three-way, four way)

PANEL FABRICS

- Available in the following panel fabrics:
 - **Grade 2** Lola
 - **Grade 3** Brinx and Mariposa
 - **Grade 4** Accent
 - Momentum **Grade 5** Meander, Tracery and Universe
- **The same fabric MUST BE used on both sides of the panel.**

PANEL FRAMES

- eO+ extruded aluminum panel frames are made from remelt billets (recycled aluminum) whenever possible and can be recycled almost endlessly
- eO+'s load bearing frames accept worksurfaces at 29"H in height. Off-Desk Accessory Bars are at 36" - 40"H and Open Shelves at 50"H. The top of the overhead storage cabinet can only be used on the 66"H Panel when the top of it is even with the top of the 66"H Panel

IMPORTANT: When specifying and installing eO+ workstations with Overhead Storage Units (shelves and overheads) and/or worksurfaces, the following rules must be followed. Failure to adhere to these rules may compromise the integrity of the installation and void the warranty.

RULE #1

Panels supporting Overhead Storage Units and/or Worksurfaces must be vertically stabilized. These panels must have worksurfaces attached to the panels using any combination of the following:

- A** - Mid-Support Gables (EMSG2xxP)
- B** - End Gables (EFG2xxP)
- C** - Worksurface Supporting Pedestals with Pedestal Connecting Brackets (GWPSxxxP/EPTPBK).
- D** - Wing Panels that are the same width as the depth of the worksurface and incorporate a set of Corner Brackets (EEWSB)

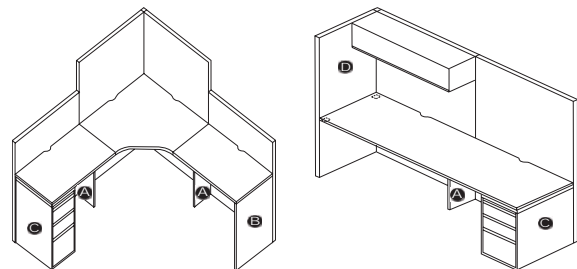

RULE #2

Panels supporting overhead storage units must have panels of equal height on either side.

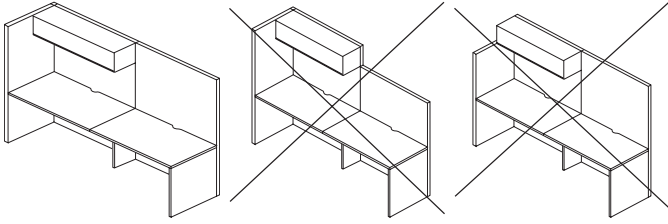

RULE #3

The width of an overhead storage unit must correspond with the width of the supporting panel.

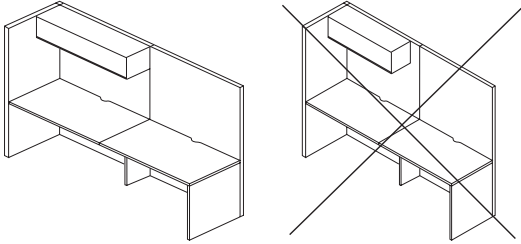

RULE #4

Whenever possible “balance” the layout by using the same size and type of overhead storage unit on both sides of the same panel. This type of layout will ensure straight panel runs.

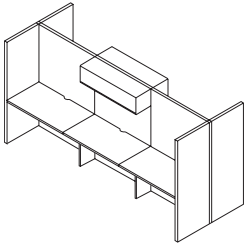

RULE #5

48” and 60” wide overhead storage units require corner posts and wing panels on both sides of the supporting panel.

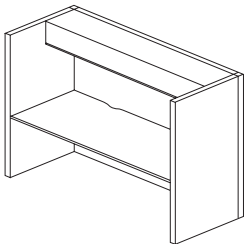

RULE #6

A run of panels without worksurfaces should be no longer than 9'-0” and must be supported with (A) Wing panels at both ends, (B) A Wing Panel at one end and a Self-Supporting Foot (EESF-1) at the other end or (C) A Wing Panel at one end and a Floor Mount (EEFM) at the other end - Not Shown.

Note: Floor Mounts MUST BE bolted to the floor.

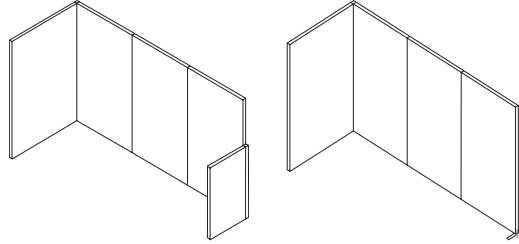

PANEL FINISHES

- Lightweight, aluminum box frame finished with **Black (BLK)** and **Tungsten 2 (TU2)** durable epoxy powder coating.

GLAZED PANELS

- Allows additional light into a workstation while creating a more open office space
- Partially Glazed Panels start at 31” from the floor. Partially Glazed Panels may also start at 42” from the floor as a No Charge option by adding “**PG42**” after the model # (ex: EPPG2466-PG42)
- Fully and Partially Glazed Panels are available in the following finishes:
 - Specify “**CPG**” for Clear Plexiglass Panels
 - Specify “**SPG**” for Smoked Plexiglass Panels
 - Specify “**FPG**” for Frosted Plexiglass Panels

PARTIAL WHITEBOARD PANELS

- Panels may be ordered with whiteboards in the upper portion of the panel on either one side or both sides
- TO ORDER PARTIAL WHITEBOARD PANEL ON ONE SIDE:
First specify the panel side which faces you “INNER SIDE” and then “OUTER SIDE” of the panel. Example: EPP3666

WB	F
F	F

EPP3666/WB/BX01/BX02

- TO ORDER PARTIAL WHITEBOARD PANEL ON TWO SIDES:
First specify the panel side which faces you “INNER SIDE” and then “OUTER SIDE” of the panel. Example: EPP3666

WB	WB
F	F

EPP3666/WB/BX01/WB/BX02

PANEL GROMMETS

- 3" diameter Panel Grommets allow wires and cables to pass through eO+ panels - **ADD \$79.**
- MUST SPECIFY POSITION:
 - GRMT1:** 34" above panel bottom and 4" in from the right panel edge (above worksurface)
 - GRMT2:** 26" above panel bottom and 4" in from the right panel edge (beneath worksurface)
 - GRMT3:** 8" above panel bottom and 4" in from the right panel edge
 - GRMT4:** 34" above panel bottom and 4" in from the left panel edge (above worksurface)
 - GRMT5:** 26" above panel bottom and 4" in from the left panel edge (beneath worksurface)
 - GRMT6:** 8" above panel bottom and 4" in from the left panel edge

Note:

- Panel Grommets NOT available on Fully Glazed Panels or in the GRMT1 and GRMT4 position on Partially Glazed Panels
- When ordering grommets in Partial Whiteboard Panels, orient the panel as shown above
- Panel Grommet finish - Black (**BLK**) or Tungsten 2 (**TU2**). will coordinate with panel finish

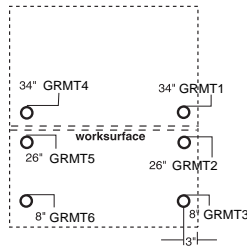
**SPECIAL SIZE PANELS**

- Custom heights and widths are available for all panels
- For custom size pricing use the **next size up plus 10%**
- Panel Heights CANNOT exceed 66"
- Panel Widths CANNOT exceed 60"

WALL ACCESS PANEL

- 18" opening in the base of the panel (from 2" above the floor to 20") to allow easy access to Electrical and Data Wall Outlets. Specify "**WAP**" after the panel model # (ex: EEP3666-WAP)

Note:

- This option can also be specified for improved air flow. **ADD \$130** to the fabric panel list price
- Wall Access Panels are NOT available on Fully Glazed Panels
- Wall Access Panels ARE available on Partially Glazed Panels and Partial Whiteboard Panels

TRANSACTION TOPS

- Tops are 1" thick, 45 pound density particleboard covered on both sides with thermally fused laminate.
- Sizes from 12" to 84" Widths
- Available in 12" Depth ONLY
- 3 mm plastic matching edge
- See page 357 for additional details

PANEL SHIPPING

- Shipped 1 per carton, unless otherwise noted
 - CUBIC FEET stated reflects TOTAL cubic footage
 - WEIGHT stated reflects the weight of ONE PANEL

LAMINATE FINISHES

Worksurfaces will have a matching 3mm plastic edge

ACJ*	Absolute Acajou
ASN*	Asian Night
AWC*	Avant Cherry
AWH*	Avant Honey
BLK	Black
BRC	Brushed Cobalt
CSJ	Constellation Java
DES*	Dark Espresso
GRY	Grey
HGT	Hayden Grey
QTM*	Quartered Mahogany
SKC*	Shaker Cherry
SOG	Storm Grey
TFW*	Tiger Fruitwood
TMA*	Tiger Mahogany
TMP*	Tiger Maple
TWL*	Tiger Walnut
WHT	White
WHC*	White Chocolate
WGY	Willow Grey
WCR*	Winter Cherry

Note:

***25% Upcharge** for WOODGRAIN FINISHES on the following Corner Worksurfaces due to diagonal grain:

- 90° Corner Worksurface
- Bi-Functional 90° Corner Worksurface
- 90° Corner Worksurface - Keyboard
- Bi-Functional 90° Corner Worksurface - Keyboard
- Corner Curved Worksurface with Keyboard Support
- "L" Transaction Tops

METAL COMPONENTS

- Panel Frame: Black BLK
Tungsten 2 TU2
- 90° Corner Posts: Black BLK
Tungsten 2 TU2
- Conduit Corner Post: Black BLK
Tungsten 2 TU2
- Panel to Wall Connectors: Black BLK
Tungsten 2 TU2
- Shelves: Black BLK
Tungsten 2 TU2
- Overhead Storage Units: Black BLK
Tungsten 2 TU2
- Pedestals: Black BLK
Tungsten 2 TU2
- Legs: Black BLK
Tungsten 2 TU2
- Transaction Top Connectors: Black BLK
Tungsten 2 TU2

HARDWARE & ACCESSORIES

- Wire Troughs: Black BLK
- Pencil Drawer: Black BLK
- Off-Desk Accessories: Black BLK
Frosted FR
- Power Bar: Black BLK
- Vertical Wire Manager: Black BLK
Tungsten 2 TU2
- "E" Series Pull Handles: Black BLK
- Panel Grommets: Black BLK
Grey GRY
- Flush Plates: Black BLK
- Kick Plate: Black BLK
Tungsten 2 TU2
- Casters: Black BLK
- Brackets and Connectors: Black BLK
Tungsten 2 TU2

PRIVACY PANELS

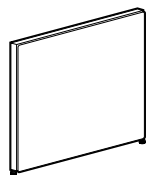

Privacy Panel

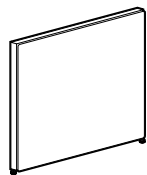

Privacy Panel

MODEL#	DIMENSIONS D x W x H	FREIGHT CLASS	WT./LBS.	CUBIC FT.	GR. 1	GR. 2	GR. 3	GR. 4
EEP1830	2 x 18 x 30	150	5	1	\$170	\$170	\$182	\$201
EEP1842	2 x 18 x 42	125	6.90	1	\$258	\$258	\$277	\$306
EEP1854	2 x 18 x 54	125	8.30	1.30	\$267	\$267	\$289	\$317
EEP1866	2 x 18 x 66	125	9.64	1.60	\$329	\$329	\$356	\$389
EEP2430	2 x 24 x 30	150	5.60	1	\$224	\$224	\$241	\$266
EEP2442	2 x 24 x 42	125	7.80	1.20	\$263	\$263	\$285	\$313
EEP2454	2 x 24 x 54	150	9.30	1.60	\$293	\$293	\$315	\$346
EEP2466	2 x 24 x 66	150	10.90	1.90	\$357	\$357	\$384	\$423
EEP3030	2 x 30 x 30	125	6.30	1	\$277	\$277	\$300	\$330
EEP3042	2 x 30 x 42	150	8.60	1.50	\$275	\$275	\$296	\$327
EEP3054	2 x 30 x 54	150	10.30	2.10	\$333	\$333	\$358	\$392
EEP3066	2 x 30 x 66	150	11.90	2.40	\$371	\$371	\$402	\$441
EEP3642	2 x 36 x 42	150	9.60	1.80	\$336	\$336	\$361	\$398
EEP3654	2 x 36 x 54	150	11.80	2.30	\$376	\$376	\$404	\$445
EEP3666	2 x 36 x 66	150	13.40	2.80	\$467	\$467	\$501	\$551
EEP4242	2 x 42 x 42	150	10.80	2.10	\$364	\$364	\$391	\$431
EEP4254	2 x 42 x 54	150	12.80	2.70	\$407	\$407	\$437	\$481
EEP4266	2 x 42 x 66	150	14.90	3.30	\$501	\$501	\$540	\$593
EEP4842	2 x 48 x 42	150	11.60	2.40	\$378	\$378	\$407	\$448
EEP4854	2 x 48 x 54	150	13.80	3.10	\$437	\$437	\$472	\$519
EEP4866	2 x 48 x 66	150	15.90	3.30	\$517	\$517	\$556	\$611
EEP5442	2 x 54 x 42	150	12.20	2.80	\$389	\$389	\$421	\$460
EEP5454	2 x 54 x 54	150	14.50	3.50	\$477	\$477	\$516	\$566
EEP5466	2 x 54 x 66	150	16.90	4.20	\$539	\$539	\$579	\$637
EEP6042	2 x 60 x 42	150	13.50	3	\$402	\$402	\$432	\$475
EEP6054	2 x 60 x 54	150	16.10	3.80	\$517	\$517	\$557	\$612
EEP6066	2 x 60 x 66	250	18.70	4.70	\$560	\$560	\$603	\$663

Lightweight aluminum box frame construction creates superior panel rigidity. Tackable substrate honeycomb core is covered with fabric. 2½" glide allows for 2" height adjustment. Panels are of actual size, eliminating creepage. Patented "knuckle-loc" design provides solid panel-to-panel connection. No connecting posts needed for straight runs. Self levelling feature maintains even height of all panels and permits fast installation and reconfiguration. Includes two "capture strip" screen connectors. Accepts suspended shelves and accessory bar.

- Must Specify Black (**BLK**) epoxy or Tungsten 2 (**TU2**) frame finish
- Custom sizes are available for eO+ Series Panels. Next size up **ADD 10%**.

Required Specifications

Frame Finish
Panel Fabric

PARTIAL WHITEBOARD PANELS

MODEL#	DIMENSIONS D x W x H	FREIGHT CLASS	WT/LBS.	CUBIC FT.	GR. 1	GR. 2	GR. 3	GR. 4
EPP1842	2 x 18 x 42	125	7.90	1	\$385	\$385	\$413	\$455
EPP1854	2 x 18 x 54	125	9.30	1.30	\$400	\$400	\$429	\$472
EPP1866	2 x 18 x 66	125	10.60	1.60	\$493	\$493	\$529	\$583
EPP2442	2 x 24 x 42	125	8.80	1.20	\$394	\$394	\$425	\$468
EPP2454	2 x 24 x 54	125	10.30	1.60	\$437	\$437	\$472	\$519
EPP2466	2 x 24 x 66	125	11.90	1.90	\$534	\$534	\$574	\$632
EPP3042	2 x 30 x 42	125	9.60	1.50	\$411	\$411	\$444	\$487
EPP3054	2 x 30 x 54	150	11.30	2.10	\$497	\$497	\$536	\$588
EPP3066	2 x 30 x 66	150	12.90	2.40	\$556	\$556	\$599	\$658
EPP3642	2 x 36 x 42	150	10.60	1.80	\$502	\$502	\$541	\$595
EPP3654	2 x 36 x 54	150	12.80	2.30	\$563	\$563	\$607	\$667
EPP3666	2 x 36 x 66	150	14.40	2.80	\$699	\$699	\$753	\$827
EPP4242	2 x 42 x 42	150	11.80	2.10	\$546	\$546	\$589	\$648
EPP4254	2 x 42 x 54	150	13.80	2.70	\$610	\$610	\$656	\$722
EPP4266	2 x 42 x 66	150	15.90	3.30	\$752	\$752	\$809	\$890
EPP4842	2 x 48 x 42	150	11.60	2.40	\$565	\$565	\$608	\$668
EPP4854	2 x 48 x 54	150	14.80	3.10	\$656	\$656	\$706	\$776
EPP4866	2 x 48 x 66	150	15.94	3.30	\$775	\$775	\$833	\$916
EPP5442	2 x 54 x 42	150	12.55	2.80	\$584	\$584	\$629	\$691
EPP5454	2 x 54 x 54	150	15.40	3.50	\$715	\$715	\$772	\$848
EPP5466	2 x 54 x 66	150	17.30	4.20	\$806	\$806	\$869	\$956
EPP6042	2 x 60 x 42	150	13.50	3	\$602	\$602	\$649	\$713
EPP6054	2 x 60 x 54	150	16.07	3.80	\$775	\$775	\$833	\$916
EPP6066	2 x 60 x 66	250	18.74	4.70	\$840	\$840	\$904	\$994

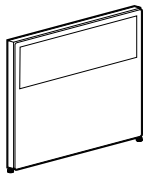

Partial Whiteboard Panel - One Side

Partial whiteboard panels available for **42", 54" and 66" h** eO+ Panels. Features a whiteboard 31" above the floor on ONE SIDE. Full fabric on the opposite side. Aluminum box frame construction with fabric covered tackable substrate. 2½" glide allows for 2" height adjustment. Includes two "capture strip" panel connectors.

• 54" and 66" high Panels Only:

- Optional partial whiteboard starting at 42" above the panel bottom is available at No Charge (both sides MUST BE the same height). Specify **(PG42)** to Panel Code (ex: EPP3666-PG42).
- Must Specify Black **(BLK)** epoxy or Tungsten 2 **(TU2)** frame finish
- Custom sizes are available for eO+ Series Panels. Next size up **ADD 10%**.

Required Specifications

Frame Finish
Panel Fabric

PARTIAL WHITEBOARD PANELS

MODEL#	DIMENSIONS	FREIGHT CLASS	WT/LBS.	CUBIC FT.	GR. 1	GR. 2	GR. 3	GR. 4
D x W x H								
EPPP1842	2 x 18 x 42	100	8.90	1	\$449	\$449	\$483	\$531
EPPP1854	2 x 18 x 54	125	10.30	1.30	\$466	\$466	\$500	\$549
EPPP1866	2 x 18 x 66	125	11.60	1.60	\$575	\$575	\$619	\$680
EPPP2442	2 x 24 x 42	100	9.80	1.20	\$459	\$459	\$495	\$544
EPPP2454	2 x 24 x 54	125	11.30	1.60	\$512	\$512	\$551	\$606
EPPP2466	2 x 24 x 66	125	12.90	1.90	\$622	\$622	\$669	\$736
EPPP3042	2 x 30 x 42	125	10.60	1.50	\$480	\$480	\$518	\$568
EPPP3054	2 x 30 x 54	150	12.30	2.10	\$580	\$580	\$625	\$687
EPPP3066	2 x 30 x 66	150	13.90	2.40	\$649	\$649	\$700	\$769
EPPP3642	2 x 36 x 42	125	11.60	1.80	\$586	\$586	\$630	\$692
EPPP3654	2 x 36 x 54	125	13.80	2.30	\$656	\$656	\$707	\$777
EPPP3666	2 x 36 x 66	150	15.40	2.80	\$816	\$816	\$878	\$965
EPPP4242	2 x 42 x 42	125	12.80	2.10	\$637	\$637	\$686	\$754
EPPP4254	2 x 42 x 54	150	14.80	2.70	\$711	\$711	\$766	\$843
EPPP4266	2 x 42 x 66	150	16.90	3.30	\$875	\$875	\$943	\$1037
EPPP4842	2 x 48 x 42	150	13.60	2.40	\$659	\$659	\$709	\$780
EPPP4854	2 x 48 x 54	150	15.80	3.10	\$765	\$765	\$823	\$905
EPPP4866	2 x 48 x 66	150	17.90	3.30	\$904	\$904	\$972	\$1068
EPPP5442	2 x 54 x 42	150	14.50	2.80	\$680	\$680	\$732	\$804
EPPP5454	2 x 54 x 54	150	17	3.50	\$834	\$834	\$898	\$988
EPPP5466	2 x 54 x 66	150	19.30	4.20	\$940	\$940	\$1012	\$1112
EPPP6042	2 x 60 x 42	150	15.50	3	\$702	\$702	\$756	\$832
EPPP6054	2 x 60 x 54	150	18.10	3.80	\$904	\$904	\$972	\$1068
EPPP6066	2 x 60 x 66	150	20.70	4.70	\$979	\$979	\$1052	\$1157

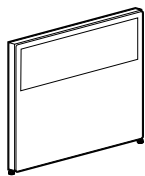

Partial Whiteboard Panel - Two Sides

Partial whiteboard panels available for **42", 54" and 66" h** eO+ Panels. Features a whiteboard 31" above the floor on BOTH SIDES. Aluminum box frame construction with fabric covered tackable substrate. 2½" glide allows for 2" height adjustment. Includes two "capture strip" panel connectors.

- **54" and 66" high Panels Only:**

Optional partial whiteboard starting at 42" above the panel bottom is available at No Charge (both sides MUST BE the same height). Specify **(PG42)** to Panel Code (ex: EPPP3666-PG42).

- Must Specify Black **(BLK)** epoxy or Tungsten 2 **(TU2)** frame finish
- Custom sizes are available for eO+ Series Panels. Next size up **ADD 10%**.

Required Specifications

Frame Finish
Panel Fabric

PARTIALLY GLAZED PANELS

MODEL#	DIMENSIONS	FREIGHT CLASS	WT/LBS.	CUBIC FT.	GR. 1	GR. 2	GR. 3	GR. 4
D x W x H								
EEPPG1842	2 x 18 x 42	125	7.90	1	\$381	\$381	\$409	\$450
EEPPG1854	2 x 18 x 54	125	9.30	1.30	\$473	\$473	\$510	\$561
EEPPG1866	2 x 18 x 66	125	10.60	1.60	\$559	\$559	\$600	\$661
EEPPG2442	2 x 24 x 42	125	8.80	1.20	\$381	\$381	\$409	\$450
EEPPG2454	2 x 24 x 54	125	10.30	1.60	\$473	\$473	\$510	\$561
EEPPG2466	2 x 24 x 66	125	11.90	1.90	\$559	\$559	\$600	\$661
EEPPG3042	2 x 30 x 42	125	9.60	1.50	\$450	\$450	\$483	\$531
EEPPG3054	2 x 30 x 54	150	11.30	2	\$551	\$551	\$593	\$654
EEPPG3066	2 x 30 x 66	150	12.90	2.40	\$636	\$636	\$686	\$754
EEPPG3642	2 x 36 x 42	150	10.60	1.80	\$497	\$497	\$537	\$589
EEPPG3654	2 x 36 x 54	150	12.80	2.30	\$606	\$606	\$653	\$717
EEPPG3666	2 x 36 x 66	150	14.40	2.80	\$712	\$712	\$766	\$843
EEPPG4242	2 x 42 x 42	150	11.80	2.10	\$542	\$542	\$584	\$641
EEPPG4254	2 x 42 x 54	150	13.80	2.70	\$662	\$662	\$711	\$782
EEPPG4266	2 x 42 x 66	150	15.90	3.30	\$781	\$781	\$841	\$925
EEPPG4842	2 x 48 x 42	150	11.60	2.40	\$584	\$584	\$627	\$690
EEPPG4854	2 x 48 x 54	150	14.80	3.10	\$715	\$715	\$771	\$847
EEPPG4866	2 x 48 x 66	150	15.94	3.80	\$848	\$848	\$914	\$1005
EEPPG5442	2 x 54 x 42	150	12.55	2.80	\$631	\$631	\$680	\$747
EEPPG5454	2 x 54 x 54	150	15.40	3.50	\$791	\$791	\$851	\$937
EEPPG5466	2 x 54 x 66	150	17.30	4.20	\$952	\$952	\$1026	\$1127
EEPPG6042	2 x 60 x 42	150	13.50	3	\$678	\$678	\$729	\$802
EEPPG6054	2 x 60 x 54	150	16.07	3	\$867	\$867	\$934	\$1027
EEPPG6066	2 x 60 x 66	125	18.74	3	\$1057	\$1057	\$1137	\$1251

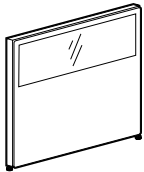

Partially Glazed Panel

Partially glazed panels available for **42", 54" and 66" h** eO+ Panels. Features a Clear, Smoked or Frosted Plexiglass window 31" above the floor. Aluminum box frame construction with fabric covered tackable substrate. 2½" glide allows for 2" height adjustment. Includes two "capture strip" panel connectors.

• 54" and 66" high Panels Only:

- Optional partial plexiglass window starting at 42" above the panel bottom is available at No Charge (both sides MUST BE the same height). Specify **(PG42)** to Panel Code (ex: EEPPG3666-PG42).
- Must Specify Black **(BLK)** epoxy or Tungsten 2 **(TU2)** frame finish
- Specify Clear **(CPG)**, Smoked **(SPG)** or Frosted **(FPG)** plexiglass
- Custom sizes are available for eO+ Series Panels. Next size up **ADD 10%**.

Required Specifications

- Frame Finish
- Panel Fabric
- Plexiglass style

FULLY GLAZED PANELS

MODEL#	DIMENSIONS	FREIGHT CLASS	WT/LBS.	CUBIC FT.	LIST PRICE
--------	------------	---------------	---------	-----------	------------

D x W x H

EEPPFG1842	2 x 20 x 42	92.5	10.80	1	\$388
EEPPFG1854	2 x 20 x 54	92.5	13.36	1.30	\$477
EEPPFG1866	2 x 20 x 66	100	15.30	1.60	\$566
EEPPFG2442	2 x 24 x 42	92.5	12.24	1.20	\$388
EEPPFG2454	2 x 24 x 54	100	15.06	1.60	\$477
EEPPFG2466	2 x 24 x 66	100	17.30	1.90	\$566
EEPPFG3042	2 x 30 x 42	100	13.59	1.50	\$458
EEPPFG3054	2 x 30 x 54	100	16.84	2	\$562
EEPPFG3066	2 x 30 x 66	100	19.94	2.40	\$665
EEPPFG3642	2 x 36 x 42	100	15.22	1.80	\$523
EEPPFG3654	2 x 36 x 54	100	19.38	2.30	\$641
EEPPFG3666	2 x 36 x 66	100	23.04	2.80	\$759
EEPPFG4242	2 x 42 x 42	100	17.16	2.10	\$588
EEPPFG4254	2 x 42 x 54	125	21.16	2.70	\$721
EEPPFG4266	2 x 42 x 66	125	26.14	3.30	\$851
EEPPFG4842	2 x 48 x 42	125	18.49	2.40	\$656
EEPPFG4854	2 x 48 x 54	125	23.50	3.10	\$803
EEPPFG4866	2 x 48 x 66	125	28.74	3.80	\$954
EEPPFG5442	2 x 54 x 42	125	20	2.80	\$721
EEPPFG6042	2 x 60 x 42	125	21.63	3	\$784

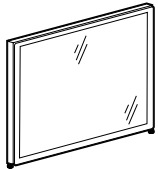

Fully Glazed Panel

Fully glazed panels available for **42", 54" and 66" h** eO+ Panels. Features a Clear, Smoked or Frosted Plexiglass window 31" above the floor. Aluminum box frame construction. 2½" glide allows for 2" height adjustment. Includes two "capture strip" panel connectors.

- Must Specify Black (**BLK**) epoxy or Tungsten 2 (**TU2**) frame finish
- Specify Clear (**CPG**), Smoked (**SPG**) or Frosted (**FPG**) plexiglass
- Custom sizes are available for eO+ Series Panels. Next size up **ADD 10%**.

PRIVACY PANEL CONNECTORS

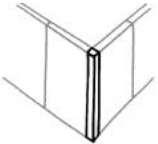

Corner Posts - 90°

EP42	2 x 2 x 42	65	4	.15	\$52
EP54	2 x 2 x 54	65	5	.17	\$65
EP66	2 x 2 x 66	60	6	.19	\$84

Enables 3-way and 4-way panel connections. Lightweight aluminum construction for superior panel connections. Self levelling feature maintains even height of panels and permits fast installation and reconfiguration. Includes two "capture strip" panel connectors.



Extended Panel Conduit/Corner Post

EP144	2 x 2 x 144	70	13.20	.75	\$223
-------	-------------	----	-------	-----	--------------

Enables 90° 3-way and 4-way connections. 144" height allows cabling to be carried from floor to ceiling. Lightweight aluminum. Includes two "capture strip" panel connectors.

Required Specifications

Frame Finish
Plexiglass style (Fully Glazed Panels)
Metal Finish - **BLK or TU2** (Connectors)

PRIVACY PANEL CONNECTORS



Corner Posts - 120°

MODEL#	DIMENSIONS D x W x H	FREIGHT CLASS	WT./LBS.	CUBIC FT.	LIST PRICE
ETP30	2 x 2 x 30	65	3	.13	\$59
ETP42	2 x 2 x 42	65	4	.15	\$71
ETP54	2 x 2 x 54	65	5	.17	\$85
ETP66	2 x 2 x 66	60	6	.19	\$104
ETP144	2 x 2 x 144	70	13.20	.75	\$242

Enables 3-way connection to **E120WS48 worksurface ONLY**. 144" height allows cabling to be carried from floor to ceiling. Lightweight aluminum construction for superior panel connection. Self levelling feature maintains even height of panel and permits fast installation and reconfiguration. Includes two "capture strip" panel connectors.



Capture Strips (One Pair) - 180°

EEPS30	0 x 0 x 30	70	.10	.50	\$13
EEPS42	0 x 0 x 42	70	.10	.50	\$13
EEPS54	0 x 0 x 54	70	.10	.50	\$13
EEPS66	0 x 0 x 66	70	.10	.50	\$13

Extruded plastic channel which connects two panels, in a straight line or a panel and a corner post. Runs the full height of the panel on both sides providing a strong connection. Two strips (one pair) are required per panel.

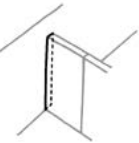

Panel to Wall Connector

EPWC30	.25 x 1 x 30	70	1	.01	\$25
EPWC42	.25 x 1 x 42	70	1	.01	\$31
EPWC54	.25 x 1 x 54	70	1.40	.01	\$37
EPWC66	.25 x 1 x 66	70	1.80	.01	\$44

Used to start a run of panels from a wall. Lightweight aluminum construction for superior panel connections. Patented "knuckle-loc" design provides rigid panel to wall connection. Includes two "capture strip" panel connectors.

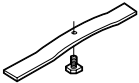

Self-Supporting Foot

EESF-1	1.5 x 19 x 1	70	2	.10	\$33
--------	--------------	----	---	-----	-------------

For e0+ panels.

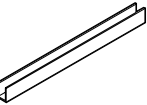

Plastic Kick Plate

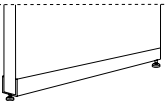

Floor Mount

EEOKP18	2 x 18 x 2.5	70	.40	.06	\$31
EEOKP24	2 x 24 x 2.5	70	.50	.07	\$35
EEOKP30	2 x 30 x 2.5	70	.60	.09	\$40
EEOKP36	2 x 36 x 2.5	70	.76	.10	\$44
EEOKP42	2 x 42 x 2.5	70	.89	.12	\$52
EEOKP48	2 x 48 x 2.5	70	1	.14	\$56
EEOKP54	2 x 60 x 2.5	70	1.15	.16	\$61
EEOKP60	2 x 60 x 2.5	70	1.26	.17	\$65

Attaches to the bottom of the fabric panels to protect from damage caused by vacuums, etc.

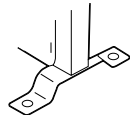

Carpet Gripper

EFM	1.5 x 3.75 x .5	70	.01	.01	\$16
-----	-----------------	----	-----	-----	-------------

For e0+ panels. **Chrome Finish only.**

EOCG	--	70	.01	.01	\$19
------	----	----	-----	-----	-------------

Fits on the adjustable glides of a Panel. Helps to stabilize the panel. Package of 10. **Available in Black (BLK) ONLY.**

Required Specifications
Metal Finish - **BLK or TU2**

WORKSURFACES	MODEL#	DIMENSIONS	FREIGHT CLASS	WT/LBS.	CUBIC FT.	LIST PRICE
--------------	--------	------------	---------------	---------	-----------	------------

D x W x H

WORKSURFACES

- Tops are 1" thick, made of 45 lb. density particle board (from 100% recycled wood chips), covered on both sides with high performance, thermally fused laminate.
- Preferred matching edge.
- Available in 18", 24" or 30" deep worksurfaces.
- All worksurfaces have threaded inserts for metal to metal connection of support hardware to panels.
- Power and communication cables are routed through cable scoops at the back of the worksurfaces.
- There is a 3/8" space between the worksurface and panel to allow wires to pass through.
- Straight and Transitional worksurfaces above 54" have two scoops. All other worksurfaces have one scoop, unless otherwise noted.
- All connection hardware must be ordered separately.
- Custom widths and depths are available for all worksurfaces. For custom size pricing use the **next size up plus 10%**.
 - More complex custom requests require a quotation. Please contact Customer Care.
 - Custom orders must indicate the Custom Quote Number and List Price. There can be no changes to the quote. Changes necessitate a new quote.

WORKSURFACE SUPPORTS

- Worksurfaces supported by supporting pedestals and supporting panel hardware.
- Supporting Pedestals are available in Black (**BLK**) or Tungsten 2 (**TU2**). Please Specify.

LEG CONSTRUCTION

- 2" Square or Tapered steel leg (2" diameter) with a custom designed leveler that adjusts up to 1½". Leveling is made easy by turning the outside of the leveler by hand. The heavy duty leveling bolt is hidden by the shroud of the leveler.
- Legs are available in Black (**BLK**) or Tungsten 2 (**TU2**). Please Specify.
- Levelers are available in Black (**BLK**) Only.

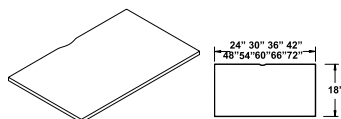
WORKSURFACES**Rectangular Worksurface - 18" deep**

EOR1824	18 x 24 x 1	60	10.12	.30	\$114
EOR1830	18 x 30 x 1	60	16.50	.54	\$114
EOR1836	18 x 36 x 1	60	19.50	.63	\$138
EOR1842	18 x 42 x 1	60	23.25	.73	\$154
EOR1848	18 x 48 x 1	60	26.25	.83	\$175
EOR1854	18 x 54 x 1	60	29.25	.93	\$197
EOR1860	18 x 60 x 1	60	33	1.02	\$223
EOR1866	18 x 66 x 1	60	36.75	1.12	\$240
EOR1872	18 x 72 x 1	60	39.75	1.21	\$288

18"D straight rectangular worksurface. Non-handed and can be interchanged on site. **Linking installations only.**

- *Worksurfaces 54" wide and larger have two scoops.*
- 66" and longer worksurfaces require a center support gable.

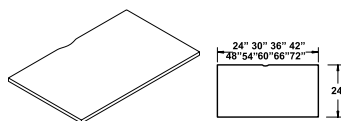
**Rectangular Worksurface - 24" deep**

EOR2424	24 x 24 x 1	60	18	.60	\$123
EOR2430	24 x 30 x 1	60	22	.72	\$130
EOR2436	24 x 36 x 1	60	26	.85	\$132
EOR2442	24 x 42 x 1	60	31	.98	\$190
EOR2448	24 x 48 x 1	60	35	1.11	\$227
EOR2454	24 x 54 x 1	60	39	1.23	\$263
EOR2460	24 x 60 x 1	60	44	1.36	\$298
EOR2466	24 x 66 x 1	60	49	1.49	\$311
EOR2472	24 x 72 x 1	60	53	1.62	\$322

24"D straight rectangular worksurface. Non-handed and can be interchanged on site. **Linking installations only.**

- *Worksurfaces 54" wide and larger have two scoops.*
- 66" and longer worksurfaces require a center support gable.

Required Specifications

Laminate Finish

WORKSURFACES

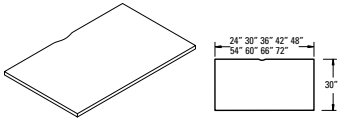

Rectangular Worksurface - 30" deep

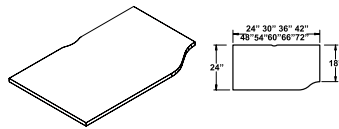

Transition Worksurface - 24" deep, LEFT

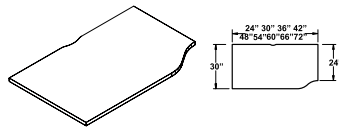

Transition Worksurface - 30" deep, LEFT

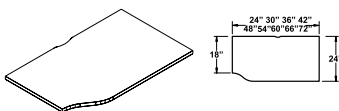

Transition Worksurface - 24" deep, RIGHT

MODEL#	DIMENSIONS D x W x H	FREIGHT CLASS	WT./LBS.	CUBIC FT.	LIST PRICE
EOR3024	30 x 24 x 1	65	22	.74	\$145
EOR3030	30 x 30 x 1	60	28	.90	\$154
EOR3036	30 x 36 x 1	60	33	1.06	\$181
EOR3042	30 x 42 x 1	60	38	1.22	\$248
EOR3048	30 x 48 x 1	60	44	1.38	\$263
EOR3054	30 x 54 x 1	60	49	1.54	\$286
EOR3060	30 x 60 x 1	60	55	1.69	\$311
EOR3066	30 x 66 x 1	60	60	1.85	\$320
EOR3072	30 x 72 x 1	60	66	2.01	\$340

30" D straight rectangular worksurface. Non-handed and can be interchanged on site. **Linking installations only.**

- Worksurfaces 54" wide and larger have two scoops.
- 66" and longer worksurfaces require a center support gable.

EOTL2424	24 x 24 x 1	65	15	.59	\$159
EOTL2430	24 x 30 x 1	65	19	.72	\$167
EOTL2436	24 x 36 x 1	65	23	.85	\$196
EOTL2442	24 x 42 x 1	65	27	.98	\$226
EOTL2448	24 x 48 x 1	65	31	1.11	\$269
EOTL2454	24 x 54 x 1	65	35	1.23	\$284
EOTL2460	24 x 60 x 1	65	39	1.36	\$319
EOTL2466	24 x 66 x 1	65	43	1.49	\$328
EOTL2472	24 x 72 x 1	65	47	1.62	\$352

Connects **right end** to a corner worksurface or a **18" D** worksurface. Left end allows the continuation of additional **24" D** worksurfaces. **Linking installations only.**

- Worksurfaces 54" wide and larger have two scoops.
- 66" and longer worksurfaces require a center support gable.

EOTL3024	30 x 24 x 1	65	19	.74	\$165
EOTL3030	30 x 30 x 1	65	24	.90	\$170
EOTL3036	30 x 36 x 1	65	29	1.06	\$197
EOTL3042	30 x 42 x 1	65	34	1.22	\$273
EOTL3048	30 x 48 x 1	65	39	1.38	\$286
EOTL3054	30 x 54 x 1	65	44	1.54	\$307
EOTL3060	30 x 60 x 1	65	49	1.69	\$351
EOTL3066	30 x 66 x 1	65	54	1.85	\$351
EOTL3072	30 x 72 x 1	65	59	2.01	\$374

Connects **right end** to a corner worksurface or a **24" D** worksurface. Left end allows the continuation of additional **30" D** worksurfaces. **Linking installations only.**

- Worksurfaces 54" wide and larger have two scoops.
- 66" and longer worksurfaces require a center support gable.

EOTR2424	24 x 24 x 1	65	15	.59	\$158
EOTR2430	24 x 30 x 1	65	19	.72	\$165
EOTR2436	24 x 36 x 1	65	23	.85	\$196
EOTR2442	24 x 42 x 1	65	27	.98	\$226
EOTR2448	24 x 48 x 1	65	31	1.11	\$269
EOTR2454	24 x 54 x 1	65	35	1.23	\$284
EOTR2460	24 x 60 x 1	65	39	1.36	\$319
EOTR2466	24 x 66 x 1	65	43	1.49	\$328
EOTR2472	24 x 72 x 1	65	47	1.62	\$352

Connects **left end** to a corner worksurface or a **18" D** worksurface. Right end allows the continuation of additional **24" D** worksurfaces. **Linking installations only.**

- Worksurfaces 54" wide and larger have two scoops.
- 66" and longer worksurfaces require a center support gable.

Required Specifications

Laminate Finish

WORKSURFACES

MODEL#

DIMENSIONS

FREIGHT CLASS

WT./LBS.

CUBIC FT.

LIST PRICE

D x W x H

EOTR3024	30 x 24 x 1	65	19	.74	\$165
EOTR3030	30 x 30 x 1	65	24	.90	\$169
EOTR3036	30 x 36 x 1	65	29	1.06	\$196
EOTR3042	30 x 42 x 1	65	34	1.22	\$273
EOTR3048	30 x 48 x 1	65	39	1.38	\$286
EOTR3054	30 x 54 x 1	65	44	1.54	\$308
EOTR3060	30 x 60 x 1	65	49	1.69	\$351
EOTR3066	30 x 66 x 1	65	54	1.85	\$351
EOTR3072	30 x 72 x 1	65	59	2.01	\$374

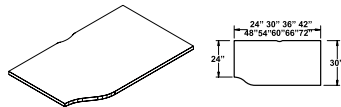

Transition Worksurface - 30" deep, RIGHT

Connects **left end** to a corner worksurface or a **24"D** worksurface. Right end allows the continuation of additional **30"D** worksurfaces. **Linking installations only.**

- *Worksurfaces 54" wide and larger have two scoops.*
- 66" and longer worksurfaces require a center support gable.

CORNER WORKSURFACES

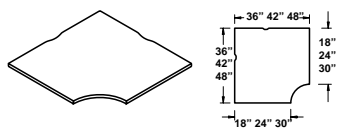

90° Corner Worksurface

EO90C3618	36 x 36 x 1	70	24	1.27	\$313
EO90C3624	36 x 36 x 1	70	30	1.47	\$330
EO90C4224	42 x 42 x 1	65	47	1.70	\$448
EO90C4230	42 x 42 x 1	65	53	1.98	\$482
EO90C4824	48 x 48 x 1	70	53	2.67	\$611
EO90C4830	48 x 48 x 1	70	55	2.67	\$611

Connects between two **18"D**, two **24"D** or two **30"D** worksurfaces. **Linking installations only.** Cannot accept keyboards.

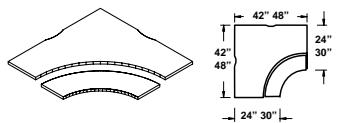

Corner Curved Worksurface with Keyboard Support

ESKC4224P	42 x 42 x 1	60	38	.95	\$1286
ESKC4230P	42 x 42 x 1	60	42	1.15	\$1435
ESKC4824P	48 x 48 x 1	60	48	1.55	\$1627
ESKC4830P	48 x 48 x 1	60	50	1.65	\$1627

Connects between two **24"D** or two **30"D** worksurfaces. Keyboard Support is 11" deep, adjusts 8" above and 6" below surface with a positive/negative tilt (+15° to -15°). Keyboard mechanism is included. Connects between two **18"D**, two **24"D** or two **30"D** worksurfaces. **Linking installations only.**

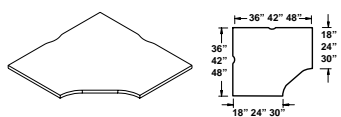

90° Corner Worksurface - Keyboard

EOCK3618	36 x 36 x 1	65	34	1.27	\$313
EOCK3624	36 x 36 x 1	65	45	1.69	\$410
EOCK4224	42 x 42 x 1	65	47	1.70	\$453
EOCK4230	42 x 42 x 1	65	50	2.12	\$562
EOCK4824	48 x 48 x 1	70	53	2.67	\$611
EOCK4830	48 x 48 x 1	70	55	2.67	\$563

Connects between two **18"D**, two **24"D** or two **30"D** worksurfaces. **Linking installations only.** Keyboard can be used when flush plates are used to join corner to other worksurfaces.

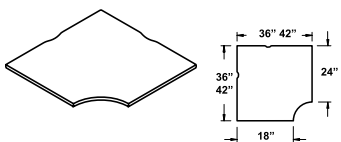

Bi-Functional 90° Corner Worksurface

EC3661824	36 x 36 x 1	70	30	1.47	\$330
EC4221824	42 x 42 x 1	65	53.89	2.04	\$448

Connects between one **18"D** on the **left**, and one **24"D** worksurface on the **right**. **Linking installations only.** Cannot accept keyboards.

Required Specifications

Laminate Finish

WORKSURFACES

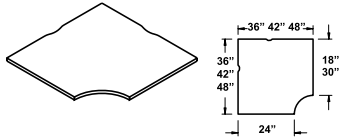

Bi-Functional 90° Corner Worksurface

MODEL#	DIMENSIONS	FREIGHT CLASS	WT/LBS.	CUBIC FT.	LIST PRICE
	D x W x H				
EC3662418	36 x 36 x 1	70	30	1.47	\$330
EC3662430	36 x 36 x 1	70	30	1.47	\$333
EC4222418	42 x 42 x 1	65	53.89	2.04	\$448
EC4222430	42 x 42 x 1	65	53.89	2.04	\$448
EC4842430	48 x 48 x 1	65	70.38	2.66	\$611

Connects between one **24\"D** worksurface on the **left** and either one **18\"D** or **30\"D** worksurface on the **right**. **Linking installations only**. Cannot accept keyboards.

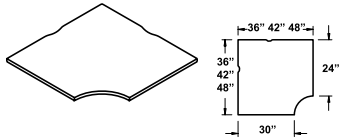

Bi-Functional 90° Corner Worksurface

EC3663024	36 x 36 x 1	70	30	1.47	\$333
EC4223024	42 x 42 x 1	65	70.38	2.66	\$448
EC4843024	48 x 48 x 1	65	70.38	2.66	\$611

Connects between one **30\"D** worksurface on the **left** and one **24\"D** worksurface on the **right**. **Linking installations only**. Cannot accept keyboards.

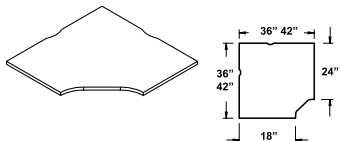

Bi-Functional 90° Corner Worksurface, Keyboard

EK3661824	36 x 36 x 1	70	30	1.47	\$333
EK4221824	42 x 42 x 1	65	53.89	2.04	\$448

Connects between one **18\"D** on the **left**, and one **24\"D** worksurface on the **right**. **Linking installations only**. **Keyboard can be used** when flush plates are used to join corner to other worksurfaces.

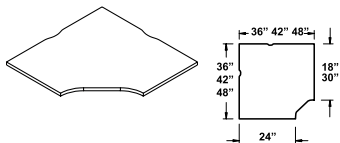

Bi-Functional 90° Corner Worksurface, Keyboard

EK3662418	36 x 36 x 1	65	39.59	1.47	\$333
EK4222418	42 x 42 x 1	65	53.89	2.04	\$448
EK4222430	42 x 42 x 1	65	53.89	2.04	\$448
EK4842430	48 x 48 x 1	65	53.89	2.04	\$611

Connects between one **24\"D** worksurface on the **left** and either one **18\"D** or **30\"D** worksurface on the **right**. **Linking installations only**. **Keyboard can be used** when flush plates are used to join corner to other worksurfaces.

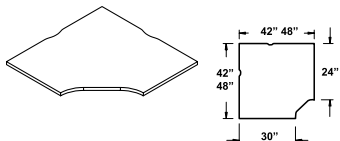

Bi-Functional 90° Corner Worksurface, Keyboard

EK4223024	42 x 42 x 1	65	53.89	2.04	\$448
EK4843024	48 x 48 x 1	65	53.89	2.04	\$611

Connects between one **30\"D** worksurface on the **left** and one **24\"D** worksurface on the **right**. **Linking installations only**. **Keyboard can be used** when flush plates are used to join corner to other worksurfaces.

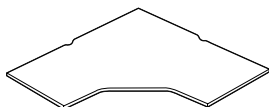

120° Worksurface

E120WS48	46 x 86 x 1	85	98	8	\$707
----------	-------------	----	----	---	--------------

Connects to two 48\" panels and one 120° post. Worksurface to be supported with end gables and/or supporting pedestals. **Linking installations only**.

Required Specifications

Laminate Finish

EXTENDED CORNER WORKSURFACES - LEFT

MODEL# DIMENSIONS FREIGHT CLASS WT/LBS. CUBIC FT. LIST PRICE

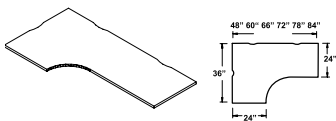

Extended Corner - 36" Deep, LEFT

	D x W x H				
ELL362448	36-24 x 48 x 1	60	43.92	1.25	\$424
ELL362460	36-24 x 60 x 1	60	52.99	1.50	\$522
ELL362466	36-24 x 66 x 1	60	57.18	1.62	\$583
ELL362472	36 x 72 x 1	60	61.58	1.75	\$663
ELL362478	36-24 x 78 x 1	60	65.98	1.87	\$708
ELL362484	36-24 x 84 x 1	60	70.38	2	\$738

Extended work surface on the **right**. Connects between two **24"D** worksurfaces. Three cable scoops. Linking installation only.

- Woodgrain laminate option NOT available on the diagonal.

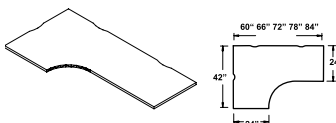

Extended Corner - 42" Deep, LEFT

ELL422460	42-24 x 60 x 1	60	55.18	1.50	\$614
ELL422466	42-24 x 66 x 1	60	61.58	1.75	\$676
ELL422472	42-24 x 72 x 1	60	65.98	1.87	\$708
ELL422478	42-24 x 78 x 1	60	70.38	2	\$801
ELL422484	42-24 x 84 x 1	60	74.38	2.12	\$863

Extended work surface on the **right**. Connects between two **24"D** worksurfaces. Three cable scoops. Linking installation only.

- Woodgrain laminate option NOT available on the diagonal.

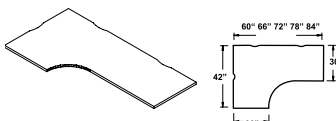

Extended Corner - 42" Deep, LEFT

ELL423060	42-24 x 60 x 1	60	63.78	1.82	\$614
ELL423066	42-24 x 66 x 1	60	69.28	1.96	\$676
ELL423072	42-24 x 72 x 1	60	74.78	2.12	\$738
ELL423078	42-24 x 78 x 1	60	80.28	2.28	\$830
ELL423084	42-24 x 84 x 1	60	85.78	2.43	\$863

Extended work surface on the **right**. Connects between two **30"D** worksurfaces. Three cable scoops. Linking installation only.

- Woodgrain laminate option NOT available on the diagonal.

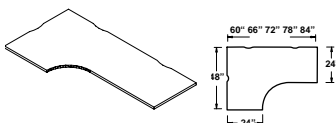

Extended Corner - 48" Deep, LEFT

ELL482460	48-24 x 60 x 1	60	65.18	1.90	\$676
ELL482466	48-24 x 66 x 1	65	96.78	3.66	\$676
ELL482472	48-24 x 72 x 1	60	76.18	1.95	\$801
ELL482478	48-24 x 78 x 1	60	74.78	1.20	\$863
ELL482484	48-24 x 84 x 1	70	78.18	4.66	\$890

Extended work surface on the **right**. Connects between two **24"D** worksurfaces. Three cable scoops. Linking installation only.

- Woodgrain laminate option NOT available on the diagonal.

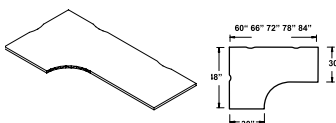

Extended Corner - 48" Deep, LEFT

ELL483060	48-24 x 60 x 1	60	68.18	1.93	\$707
ELL483066	48-24 x 66 x 1	60	73.68	2.09	\$761
ELL483072	48-24 x 72 x 1	60	79.18	2.25	\$832
ELL483078	48-24 x 78 x 1	60	84.68	2.40	\$925
ELL483084	48-24 x 84 x 1	60	90.18	2.56	\$985

Extended work surface on the **right**. Connects between two **30"D** worksurfaces. Three cable scoops. Linking installation only.

- Woodgrain laminate option NOT available on the diagonal.

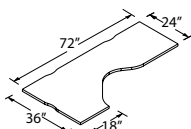

Extended Corner - LEFT, Keyboard

ELKL2472	36-24 x 72 x 1	65	73	2.70	\$627
----------	----------------	----	----	------	--------------

Extended work surface on the **right**. Connects between one **18"D** work surface on **left** and one **24"D** work surface on the **right**. Three cable scoops. Linking installation only.

- Woodgrain laminate option NOT available on the diagonal.

Required Specifications

Laminate Finish

EXTENDED CORNER WORKSURFACES - RIGHT

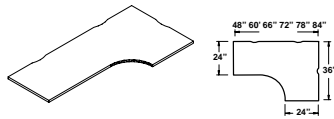

Extended Corner - 36" Deep, RIGHT

MODEL#	DIMENSIONS	FREIGHT CLASS	WT./LBS.	CUBIC FT.	LIST PRICE
	D x W x H				
ELR362448	24-36 x 48 x 1	60	43.92	1.25	\$424
ELR362460	24-36 x 60 x 1	60	52.99	1.50	\$522
ELR362466	24-36 x 66 x 1	60	57.18	1.62	\$583
ELR362472	24-36 x 72 x 1	60	61.58	1.75	\$663
ELR362478	24-36 x 78 x 1	60	65.98	1.87	\$708
ELR362484	24-36 x 84 x 1	60	70.38	2	\$738

Extended work surface on the **left**. Connects between two **24"D** work surfaces. Three cable scoops. Linking installation only.
 • Woodgrain laminate option **NOT** available on the diagonal.

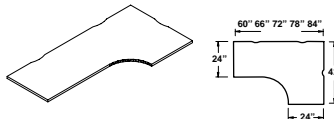

Extended Corner - 42" Deep, RIGHT

ELR422460	24-42 x 60 x 1	60	57.18	1.63	\$614
ELR422466	24-42 x 66 x 1	60	61.58	1.75	\$675
ELR422472	24-42 x 72 x 1	60	65.98	1.87	\$708
ELR422478	24-42 x 78 x 1	60	70.38	2	\$800
ELR422484	24-42 x 84 x 1	60	74.38	2.12	\$863

Extended work surface on the **left**. Connects between two **24"D** work surfaces. Three cable scoops. Linking installation only.
 • Woodgrain laminate option **NOT** available on the diagonal.

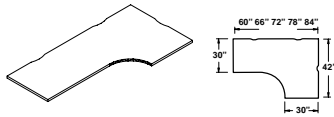

Extended Corner - 42" Deep, RIGHT

ELR423060	24-42 x 60 x 1	60	63.78	1.82	\$614
ELR423066	24-42 x 66 x 1	60	69.28	1.96	\$675
ELR423072	24-42 x 72 x 1	60	74.78	2.12	\$738
ELR423078	24-42 x 78 x 1	60	80.28	2.28	\$830
ELR423084	24-42 x 84 x 1	60	85.78	2.43	\$863

Extended work surface on the **left**. Connects between two **30"D** work surfaces. Three cable scoops. Linking installation only.
 • Woodgrain laminate option **NOT** available on the diagonal.

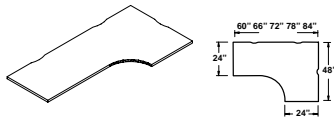

Extended Corner - 48" Deep, RIGHT

ELR482460	24-48 x 60 x 1	60	65.18	1.90	\$676
ELR482466	24-48 x 66 x 1	65	96.78	3.66	\$676
ELR482472	24-48 x 72 x 1	60	76.18	1.95	\$800
ELR482478	24-48 x 78 x 1	60	74.78	1.20	\$863
ELR482484	24-48 x 84 x 1	60	82.12	1.46	\$890

Extended work surface on the **left**. Connects between two **24"D** work surfaces. Three cable scoops. Linking installation only.
 • Woodgrain laminate option **NOT** available on the diagonal.

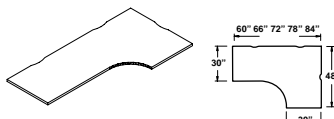

Extended Corner - 48" Deep, RIGHT

ELR483060	24-48 x 60 x 1	60	68.18	1.93	\$708
ELR483066	24-48 x 66 x 1	60	73.68	2.09	\$761
ELR483072	24-48 x 72 x 1	60	79.18	2.25	\$832
ELR483078	24-48 x 78 x 1	60	84.68	2.40	\$925
ELR483084	24-48 x 84 x 1	60	90.18	2.56	\$985

Extended work surface on the **left**. Connects between two **30"D** work surfaces. Three cable scoops. Linking installation only.
 • Woodgrain laminate option **NOT** available on the diagonal.

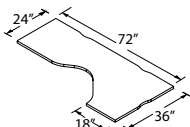

Extended Corner - RIGHT, Keyboard

ELKR2472	24-36 x 72 x 1	65	73	2.70	\$627
----------	----------------	----	----	------	--------------

Extended work surface on the **left**. Connects between one **18"D** work surface on **right** and one **24"D** work surface on the **left**. Three cable scoops. Linking installation only.
 • Woodgrain laminate option **NOT** available on the diagonal.

Required Specifications

Laminate Finish

QUARTER ROUND WORKSURFACES

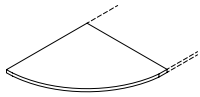

Quarter Round Panel Worksurface - LEFT

MODEL# DIMENSIONS FREIGHT CLASS WT/LBS. CUBIC FT. LIST PRICE

	D x W x H				
ELC1818L	18 x 18 x 1	65	7	.30	\$97
ELC2424L	24 x 24 x 1	65	17	.58	\$160
ELC3030L	30 x 30 x 1	65	25.50	.88	\$261

The worksurface edge running along the panel face is a slightly different length than that of the worksurface end, causing the surface to be handed. **The user edge** against the adjacent worksurface runs straight for 3" before starting to curve.

Linking installation only.

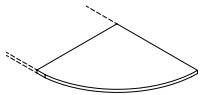

Quarter Round Panel Worksurface - RIGHT

ELC1818R	18 x 18 x 1	65	7	.30	\$97
ELC2424R	24 x 24 x 1	65	17	.58	\$160
ELC3030R	30 x 30 x 1	65	25.50	.88	\$261

The worksurface edge running along the panel face is a slightly different length than that of the worksurface end, causing the surface to be handed. **The user edge** against the adjacent worksurface runs straight for 3" before starting to curve.

Linking installation only.

HATCHET ISLANDS (ATTACHABLE)

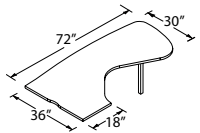

Hatchet Island with Post - LEFT

EMG3672LP	36 x 72 x 29	65	78.50	3.22	\$866
-----------	--------------	----	-------	------	--------------

Extended island worksurface on the **right**. Connects to **18"D** worksurfaces on the **left**. Cable scoop is in the center of the 36" wide edge. Includes 2" square monopost. Shipped RTA (ready to assemble). **Linking installation only.**

- Woodgrain laminate option **NOT** available on the diagonal.
- Post is shipped in separate carton. MUST Specify Black (**BLK**) or Tungsten 2 (**TU2**) finish.

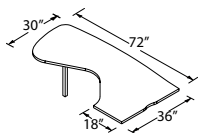

Hatchet Island with Post - RIGHT

EMG3672RP	36 x 72 x 29	65	78.50	3.22	\$866
-----------	--------------	----	-------	------	--------------

Extended island worksurface on the **left**. Connects to **18"D** worksurfaces on the **right**. Cable scoop is in the center of the 36" wide edge. Includes 2" square monopost. Shipped RTA (ready to assemble). **Linking installation only.**

- Woodgrain laminate option **NOT** available on the diagonal.
- Post is shipped in separate carton. MUST Specify Black (**BLK**) or Tungsten 2 (**TU2**) finish.

"D" ISLANDS (ATTACHABLE)

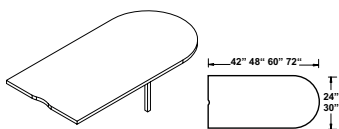

"D" Island with Post

ED2442IP	24 x 42 x 29	70	33.50	1.50	\$340
ED2448IP	24 x 48 x 29	65	37.50	1.63	\$351
ED2460IP	24 x 60 x 29	65	45.50	1.88	\$411
ED2472IP	24 x 72 x 29	65	58.29	2.52	\$445
ED3048IP	30 x 48 x 29	65	44.50	1.89	\$413
ED3060IP	30 x 60 x 29	65	54.50	2.21	\$444
ED3072IP	30 x 72 x 29	65	64.50	2.53	\$490

Attaches to edge of worksurfaces. Cable scoop is in the center of the end. Includes 2" square monopost. Shipped RTA (ready to assemble). **Linking installation only.**

- Post is shipped in separate carton. MUST Specify Black (**BLK**) or Tungsten 2 (**TU2**) finish.

Required Specifications

Laminate Finish
Post Finish (Islands)

"D" ISLANDS (ATTACHABLE)

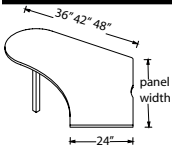

120° "D" Island with Post - LEFT

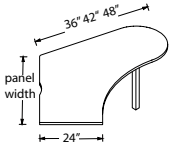

120° "D" Island with Post - RIGHT

MODEL#	DIMENSIONS D x W x H	FREIGHT CLASS	WT./LBS.	CUBIC FT.	LIST PRICE
ECWSDL36P	24 x 36 x 29	65	44.50	1.89	\$1038
ECWSDL42P	24 x 42 x 29	70	36.29	1.68	\$1102
ECWSDL48P	24 x 48 x 29	65	50.50	2.09	\$1216

Connects to both a **24"D** worksurface and a panel on the **right**. Cable scoop is in the center of the end. Includes 2" square monopost. Shipped RTA (ready to assemble). **Linking installation only.**

- Post is shipped in separate carton. MUST Specify Black (**BLK**) or Tungsten 2 (**TU2**) finish.

ECWSDR36P	24 x 36 x 29	65	44.50	1.89	\$1038
ECWSDR42P	24 x 42 x 29	70	36.29	1.68	\$1102
ECWSDR48P	24 x 48 x 29	65	50.50	2.09	\$1216

Connects to both a **24"D** worksurface and a panel on the **left**. Cable scoop is in the center of the end. Includes 2" square monopost. Shipped RTA (ready to assemble). **Linking installation only.**

- Post is shipped in separate carton. MUST Specify Black (**BLK**) or Tungsten 2 (**TU2**) finish.

"P" ISLANDS (ATTACHABLE)

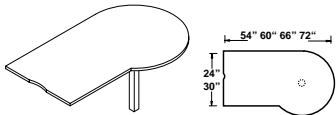

"P" Island with Post - LEFT

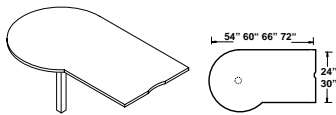

"P" Island with Post - RIGHT

EP24540LP	24 x 54 x 29	70	45.09	2.02	\$388
EP24600LP	24 x 60 x 29	65	62.51	2.60	\$415
EP24660LP	7.54 x 65.75 x 29	65	65.98	2.80	\$445
EP24720LP	24 x 72 x 29	65	71.48	3.02	\$561
EP30606LP	30 x 60 x 29	65	71.48	3.02	\$471
EP30666LP	30 x 66 x 29	65	78.08	3.27	\$631
EP30726LP	30 x 72 x 29	65	84.50	2.93	\$673

Attaches to edge of worksurfaces. Cable scoop is in the center of the end. Includes 2" square monopost. Shipped RTA (ready to assemble). **Linking installation only.**

- Post is shipped in separate carton. MUST Specify Black (**BLK**) or Tungsten 2 (**TU2**) finish.

EP24540RP	24 x 54 x 29	70	45.09	2.02	\$388
EP24600RP	24 x 60 x 29	65	62.51	2.60	\$415
EP24660RP	24 x 66 x 29	65	65.98	2.80	\$445
EP24720RP	24 x 72 x 29	65	71.48	3.02	\$561
EP30606RP	30 x 60 x 29	65	71.48	3.02	\$471
EP30666RP	30 x 66 x 29	65	78.08	3.27	\$631
EP30726RP	30 x 72 x 29	65	84.50	2.93	\$673

Attaches to edge of worksurfaces. Cable scoop is in the center of the end. Includes 2" square monopost. Shipped RTA (ready to assemble). **Linking installation only.**

- Post is shipped in separate carton. MUST Specify Black (**BLK**) or Tungsten 2 (**TU2**) finish.

WEDGE ISLANDS (ATTACHABLE)

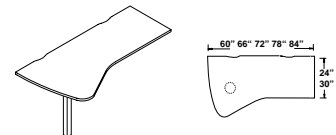

Wedge Island - LEFT

EWWS2460LP	24 x 60 x 29	65	57.49	2.33	\$489
EWWS2466LP	24 x 66 x 29	65	56.39	1.98	\$524
EWWS2472LP	24 x 72 x 29	65	66.29	2.67	\$562
EWWS2478LP	24 x 78 x 29	65	70.68	2.83	\$613
EWWS2484LP	24 x 84 x 29	65	75.08	3	\$649
EWWS3060LP	30 x 60 x 29	65	68.49	2.75	\$548
EWWS3066LP	30 x 66 x 29	65	73.98	2.96	\$595
EWWS3072LP	30 x 72 x 29	65	79.48	3.17	\$639
EWWS3078LP	30 x 78 x 29	65	84.98	3.37	\$685
EWWS3084LP	30 x 84 x 29	65	90.48	3.58	\$728

Attaches to edge of worksurfaces. Two cable scoops on the back side of the worksurface. Includes 2" square monopost. Conference end is 10" deeper than standard depth. Shipped RTA (ready to assemble). **Linking installation only.**

- Post is shipped in separate carton. MUST Specify Black (**BLK**) or Tungsten 2 (**TU2**) finish.

Required Specifications

- Laminate Finish
- Post Finish (Islands)

WEDGE ISLANDS (ATTACHABLE)

MODEL# DIMENSIONS FREIGHT CLASS WT./LBS. CUBIC FT. LIST PRICE

D x W x H

EWWS2460RP	24 x 60 x 29	65	57.49	2.33	\$489
EWWS2466RP	24 x 66 x 29	65	56.39	1.98	\$524
EWWS2472RP	24 x 72 x 29	65	66.29	2.67	\$562
EWWS2478RP	24 x 78 x 29	65	70.68	2.83	\$613
EWWS2484RP	24 x 84 x 29	65	75.08	3	\$649
EWWS3060RP	30 x 60 x 29	65	68.49	2.75	\$548
EWWS3066RP	30 x 66 x 29	65	73.98	2.96	\$595
EWWS3072RP	30 x 72 x 29	65	79.48	3.17	\$639
EWWS3078RP	30 x 78 x 29	65	84.98	3.37	\$685
EWWS3084RP	30 x 84 x 29	65	90.48	3.58	\$728

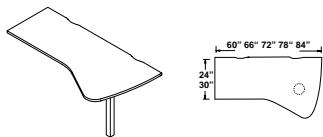

Wedge Island - RIGHT

Attaches to edge of worksurfaces. Two cable scoops on the back side of the worksurface. Includes 2" square monopost. Conference end is 10" deeper than standard depth. Shipped RTA (ready to assemble). **Linking installation only.**

- Post is shipped in separate carton. MUST Specify Black (BLK) or Tungsten 2 (TU2) finish.

RADIUS SPANNER ISLANDS

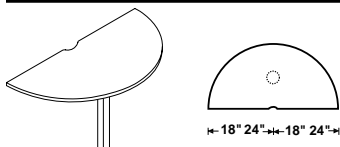

Radius Spanner Island - 18" and 24"D

EORW18P	19.5 x 39 x 29	60	24	.74	\$316
EORW24P	25.5 x 51 x 29	65	34	1.16	\$433

Used to connect two back-to-back units of the same depth with a panel. Cable scoop is on the straight edge. Includes 2" square monopost. Shipped RTA (ready to assemble). **Linking installation only.**

- Post is shipped in separate carton. MUST Specify Black (BLK) or Tungsten 2 (TU2) finish.

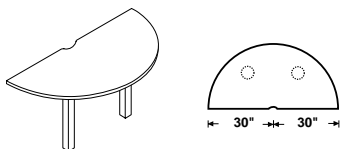

Radius Spanner Island - 30"D

EORW30P	31.5 x 63 x 29	65	51	1.76	\$612
---------	----------------	----	----	------	--------------

Used to connect two back-to-back units of the same depth with a panel. Cable scoop is on the straight edge. Includes two 2" square monoposts. Shipped RTA (ready to assemble). **Linking installation only.**

- Post is shipped in separate carton. MUST Specify Black (BLK) or Tungsten 2 (TU2) finish.

TRANSACTION TOPS - NOTES

- Tops are 1" thick, 45 lb. density particleboard covered on both sides with thermally fused laminate.
- Available in 12" depth only.
- For a Custom Width, ex: ETT1232, take the next larger size - ETT1236 plus 10%.
- Connecting hardware not included.
- "L" Transaction Top (ELCTT90) covers 12" of a panel.
- Preferred matching edge on all sides

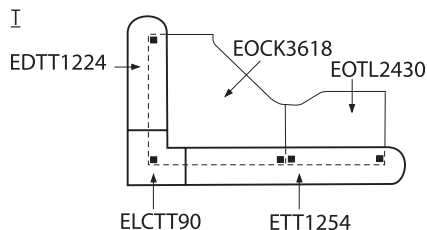

Two Way Connector Transaction Top (ELCTT90) - Use to link Transaction Tops together at 90°.

Required Specifications

- Laminate Finish
- Post Finish (Islands)

TRANSACTION TOPS

MODEL# DIMENSIONS FREIGHT CLASS WT/LBS. CUBIC FT. LIST PRICE

D x W x H

ETT1212	12 x 12 x 1	65	6	.22	\$62
ETT1218	12 x 18 x 1	65	8	.30	\$75
ETT1224	12 x 24 x 1	65	10	.38	\$86
ETT1230	12 x 30 x 1	65	13	.46	\$105
ETT1236	12 x 36 x 1	65	15	.54	\$120
ETT1242	12 x 42 x 1	65	18	.62	\$135
ETT1248	12 x 48 x 1	65	20	.70	\$147
ETT1254	12 x 54 x 1	65	23	.78	\$167
ETT1260	12 x 60 x 1	65	25	.86	\$190
ETT1266	12 x 66 x 1	65	28	.94	\$211
ETT1272	12 x 72 x 1	65	30	1.02	\$230
ETT1278	12 x 78 x 1	65	32	1.10	\$253
ETT1284	12 x 84 x 1	65	35	1.18	\$274

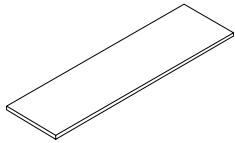

Straight Transaction Top

12" deep x 1" thick top. Attaches to the top of a 42" panel. Connecting hardware not included. For connecting hardware, see next page.

- All worksurface finishes will have a matching 3mm edge

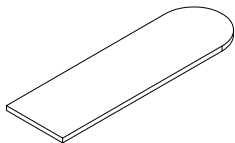

"D" Transaction Top

EDTT1230	12 x 36 x 1	65	18	.65	\$125
EDTT1236	12 x 42 x 1	65	20	.69	\$138
EDTT1242	12 x 48 x 1	60	23	.74	\$158
EDTT1248	12 x 54 x 1	60	26	.77	\$172
EDTT1254	12 x 60 x 1	60	28	.85	\$193
EDTT1260	12 x 66 x 1	60	31	.94	\$220
EDTT1266	12 x 72 x 1	60	36	1.10	\$244
EDTT1272	12 x 78 x 1	60	36	1.10	\$263

12" deep x 1" thick top. Attaches to the top of a 42" panel. Used at the end of a panel run where surface can overhang. Connecting hardware not included. For connecting hardware, see next page.

- All worksurface finishes will have a matching 3mm edge

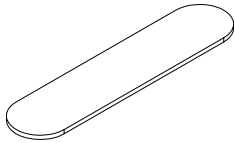

Double "D" Transaction Top

EDDTT1248	12 x 60 x 1	60	28	.85	\$180
EDDTT1254	12 x 66 x 1	60	30	.90	\$198
EDDTT1260	12 x 72 x 1	60	31	.94	\$229
EDDTT1272	12 x 84 x 1	60	36	1.10	\$276

12" deep x 1" thick top. Attaches to the top of a 42" panel. Top overhangs the panel by 6" on either end. Connecting hardware not included. For connecting hardware, see next page.

- All worksurface finishes will have a matching 3mm edge

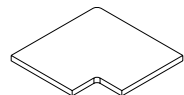

"L" Transaction Top

ELCTT90	19 x 19 x 1	70	12	.75	\$113
---------	-------------	----	----	-----	--------------

19" deep x 1" thick top. Attaches to the top of a 42" panel. Used where two panels meet at a 90° angle. Covers 12" of a panel. Connecting hardware not included. For connecting hardware, see next page.

- All worksurface finishes will have a matching 3mm edge

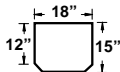
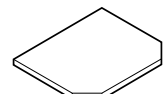

Three-Way Corner Transaction Top

EOTT3W	19 x 13 x 1	85	11.70	.90	\$220
--------	-------------	----	-------	-----	--------------

19" deep x 1" thick top. Attaches to the top of a 42" panel. To connect three way transaction tops; two at 180°, the other at 90°. Deduct 6" from the width of each adjoining transaction top. Connecting hardware not included. For connecting hardware, see next page.

- All worksurface finishes will have a matching 3mm edge

Required Specifications

Laminate Finish

TRANSACTION TOPS

MODEL# DIMENSIONS FREIGHT CLASS WT./LBS. CUBIC FT. LIST PRICE

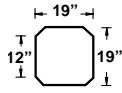
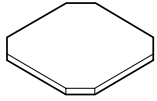

Four-Way Corner Transaction Top

MODEL#	D x W x H	FREIGHT CLASS	WT./LBS.	CUBIC FT.	LIST PRICE
EOTT4W	19 x 19 x 1	85	13.10	.90	\$220

19"D x 1" thick top. Attaches to the top of a 42" panel. To connect four transaction tops at 90°. Deduct 6" from the width of each adjoining transaction top. Connecting hardware not included. For connecting hardware, see below.

- All worksurface finishes will have a matching 3mm edge

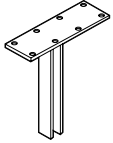

Transaction Top Connector - Corner Post

ETTCPOSTC	2.75 x 7.5 x 6	60	2	.01	\$33
-----------	----------------	----	---	-----	-------------

Fits into Corner Post. Plastic corner cap must be removed.

- Pricing shown is for one piece.
- MUST Specify Black (**BLK**) or Tungsten 2 (**TU2**) finish.

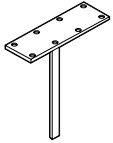

Transaction Top Connector - Panel

ETTPANELC	2.75 x 7.5 x 5.25	60	2	.01	\$33
-----------	-------------------	----	---	-----	-------------

Fits into Panel Frame. Plastic top cap must be removed.

- Pricing shown is for one piece.
- Adjacent panels must be the same height.
- MUST Specify Black (**BLK**) or Tungsten 2 (**TU2**) finish.

WORKSURFACE SUPPORT HARDWARE

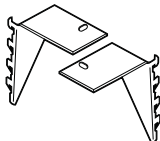
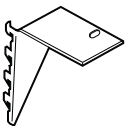

Worksurface Bracket

EEWSBL (Left)	.25 x 1 x 66	70	.10	.10	\$15
EEWSBR (Right)	.25 x 1 x 66	70	.10	.10	\$15
EEWSB (Set)	.25 x 1 x 66	70	.10	.10	\$30

Attaches worksurface to panel. *EEWSB (Set) includes one left and one right worksurface bracket.

- MUST Specify Black (**BLK**) or Tungsten 2 (**TU2**) finish.

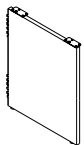

Full End Gable

EFEG18P	18 x 1 x 27.62	60	16.50	.54	\$180
EFEG24P	24 x 1 x 27.62	60	22	.72	\$195
EFEG30P	30 x 1 x 27.62	60	28	.90	\$283

Attaches a worksurface to Panel with two connecting brackets. Provides solid support of a worksurface. Includes EPTEGBK Bracket Kit.

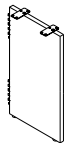

Mid-Supporting Gable

EMSG224P	10 x 1 x 27.62	70	9	.50	\$180
EMSG230P	16 x 1 x 27.62	65	12	.50	\$180

Provides support to a worksurface spanning two panels. Also used to support and link two adjoining worksurfaces. Includes EPTSGBK Bracket Kit.

Required Specifications

- Laminate Finish
- Metal Finish (Connectors)

WORKSURFACE SUPPORT HARDWARE

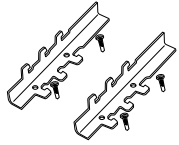

Pedestal Connecting Bracket Kit

MODEL#	DIMENSIONS D x W x H	FREIGHT CLASS	WT/LBS.	CUBIC FT.	LIST PRICE
EPTPBK	1 x 1 x 6	70	1	.01	\$19

Screws to the back of the Pedestal at the top and bottom. Brackets connect Pedestal to Panel.

- Pricing shown is for a pair of brackets. **One pair of brackets is required per pedestal.**
- MUST Specify Black (**BLK**) or Tungsten 2 (**TU2**) finish.

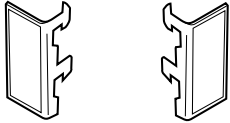

Panel to Desk Connector with Velcro

EEOPBL (Left)	.25 x 1 x 66	70	.10	.01	\$15
EEOPBR (Right)	.25 x 1 x 66	70	.10	.01	\$15

Attaches flush end gable of desk to end of panel. Fits into panel slot.

- Pricing shown is for one piece.
- MUST Specify Black (**BLK**) or Tungsten 2 (**TU2**) finish.

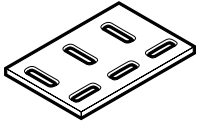

Flat Bracket

EFB	3.5 x 4.5	70	1	.20	\$16
-----	-----------	----	---	-----	-------------

Assures alignment on adjoining worksurfaces of the same height.

- Pricing shown is for one piece.
- Available in Black (**BLK**) only



Leg with Leveler - Square

ELS291	5.25 x 5.25 x 27	92.5	5.50	.52	\$100
ELS294	5.25 x 5.25 x 27	92.5	21.20	2.10	\$390

2" square leg with leveler that adjusts up to 1/2". Wood screws included. Ships UPS.

- **ELS291** ships 1 per carton. **ELS294** ships 4 per carton.
- MUST Specify Black (**BLK**) or Tungsten 2 (**TU2**) finish.

Required Specifications
Metal Finish

STORAGE NOTES**PEDESTALS**

D x W x H

- Worksurface Supporting Pedestals are 27.62" high and can directly support worksurfaces by screwing through the top of the pedestal and into the underside of the worksurface. A Pedestal Connecting Bracket secures the pedestal to a panel (not included).
- Freestanding Pedestals are 27.12"H and can slide under a panel attached worksurface.
- Cannot be converted to mobile pedestals in the field.
- Lock included.
- Steel construction for durability.
- G Series Pedestals have a looped full pull drawer front while E Series Pedestals incorporate Soft touch Hytre™ pull handles.
- One pencil tray and plate divider included in the top box drawer.
- Leveling glides provide 1" height adjustment.
- Mobile pedestal NOT for use to support worksurfaces.
- Available in Black (**BLK**) and Tungsten 2 (**TU2**). Please Specify.
- Worksurface tops are available for pedestals when they are freestanding.
- Box drawers have ¾ extension steel ball bearing suspension.
- File drawers have full steel ball bearing suspension.
- Side rails accommodate letter hanging folders.
- File bars included for legal size hanging file folders for 19", 23"/24" and 29"/30".

LOCKS

- Pedestals - All drawers are locking (standard position on the front, top right).
- Overheads with Retracting Doors - Can be ordered for field installation only (model **ESLOCK**). **ADD \$28**.
- All keying is random.
- All components within a workstation or a private office can be keyed alike or keyed differently at No Charge. Delivery times will vary.
- Quantity 1 - 150 Workstations - Standard Delivery Time.
- Quantity 151+ Workstations - Additional Lead Time (approx. 3 weeks).
- **Note:** When ordering 'specified' keying, tag each component of the workstation or office with a lock number between 400-550. Your shipping documentation and invoicing will confirm both the "specified" lock number and any other tagging instructions for each component.

PANEL ATTACHED STORAGE

- All panel attached storage is constructed of steel for durability.
- Overhead Storage Units are NOT standard with locks.
- Interior dimensions of the Overhead Storage Unit are 11 ¾"D and 12"H. The shelf is 12"D and has a back lip to protect the panel fabric.

PERSONAL STORAGE TOWERS

- Personal storage towers have looped full pull fronts to match the G Series pedestals.
- Locks are included.
- Leveling glides provide ½" height adjustment.

Note:

- Custom widths and depths are NOT available for Pedestals, Panel Attached Storage and Personal Towers.
- Matching 9100/9300P series lateral file and storage options. See the **Filing and Storage** section, beginning on page 614.

OPTIONS

- Desk Mounted Accessories include Keyboard Corner Plate and Pencil Drawer.
- Panel-Mounted Accessories include Coat Hook, Self-Supporting Foot and Accessory Rail.
- Accessory Rail supports additional storage and organizational accessories
- For keyboard trays, see **Productivity Solutions by Global**, beginning on page 490.

SHIPPING

- Shipped R.T.A. (Ready To Assemble).
- 1 per carton, unless otherwise noted.

ELECTRICAL COMPONENTS

- Desk mounted accessories include Adapt power/data module (model # **EUEDM**), mini-adapt power module (model # **EUTEM**) and mini-adapt data module (model # **EUTDM**).
- Panel mount power bar includes four receptacles, two data jack adapters, two cord management channels, sliding bracket and bezel tree.

G SERIES PEDESTALS

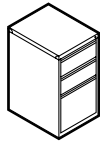

Box/Box/File Pedestal

MODEL#	DIMENSIONS D x W x H	FREIGHT CLASS	WT/LBS.	CUBIC FT.	LIST PRICE
GWPS19BBF	19 x 15 x 27.62	70	70	4.30	\$417
GWPS24BBF	24 x 15 x 27.62	85	84	5.80	\$423
GWPS30BBF	30 x 15 x 27.62	85	94	7.03	\$432

Two box and one file drawer pedestal. **Designed to support worksurfaces.** Looped full pull. Lock mounted on the right hand side. One pencil tray and one plate divider included. Levelling glides are standard.

- MUST Specify Black (BLK) or Tungsten 2 (TU2) finish.

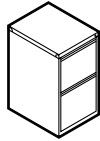

File/File Pedestal

GWPS19FF	19 x 15 x 27.62	70	70	4.30	\$417
GWPS24FF	24 x 15 x 27.62	85	84	5.80	\$423
GWPS30FF	30 x 15 x 27.62	85	94	7.03	\$432

Two file drawer pedestal. **Designed to support worksurfaces.** Looped full pull. Lock mounted on the right hand side. Levelling glides are standard.

- MUST Specify Black (BLK) or Tungsten 2 (TU2) finish.

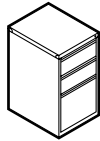

Box/Box/File Pedestal

GWP-19BBF	19 x 15 x 27.12	92.5	69	6	\$398
GWP-23BBF	23 x 15 x 27.12	92.5	75	7	\$411
GWP-29BBF	29 x 15 x 27.12	100	80	9	\$425

Two box and one file drawer pedestal. **Freestanding.** Looped full pull. Lock mounted on the right hand side. One pencil tray and one plate divider included. Levelling glides are standard.

- MUST Specify Black (BLK) or Tungsten 2 (TU2) finish.

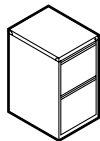

File/File Pedestal

GWP-19FF	19 x 15 x 27.12	92.5	69	6	\$398
GWP-23FF	23 x 15 x 27.12	92.5	75	7	\$411
GWP-29FF	29 x 15 x 27.12	100	80	9	\$425

Two file drawer pedestal. **Freestanding.** Looped full pull. Lock mounted on the right hand side. Levelling glides are standard.

- MUST Specify Black (BLK) or Tungsten 2 (TU2) finish.

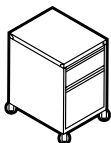

Box/File Pedestal - Mobile

GMP-19BF	19 x 15 x 22	70	76	5	\$411
GMP-23BF	23 x 15 x 22	85	80	6	\$425
GMP-29BF	29 x 15 x 22	85	86	7	\$438

One box and one file drawer pedestal. Looped full pull. Lock mounted on the right hand side. One pencil tray and one plate divider included. Includes casters already attached.

- MUST Specify Black (BLK) or Tungsten 2 (TU2) finish.

Required Specifications

Metal Finish

E SERIES PEDESTALS

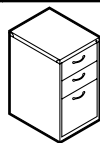

Box/Box/File Pedestal

MODEL#	DIMENSIONS	FREIGHT CLASS	WT/LBS.	CUBIC FT.	LIST PRICE
--------	------------	---------------	---------	-----------	------------

D x W x H

EWPS19BBF	19 x 15 x 27.62	92.5	69	5.90	\$411
EWPS24BBF	24 x 15 x 27.62	92.5	75	7	\$425
EWPS30BBF	30 x 15 x 27.62	85	94	7.25	\$438

Two box and one file drawer pedestal. **Designed to support workspaces.** Soft touch Hytrel pull handles in Black (BLK) only. Lock mounted on the right hand side. One pencil tray and one plate divider included. Levelling glides are standard.

- MUST Specify Black (**BLK**) or Tungsten 2 (**TU2**) finish.

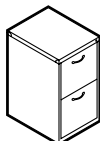

File/File Pedestal

EWPS19FF	19 x 15 x 27.62	92.5	69	5.90	\$411
EWPS24FF	24 x 15 x 27.62	92.5	75	7	\$425
EWPS30FF	30 x 15 x 27.62	85	94	7.25	\$438

Two file drawer pedestal. **Designed to support workspaces.** Soft touch Hytrel pull handles in Black (BLK) only. Lock mounted on the right hand side. Levelling glides are standard.

- MUST Specify Black (**BLK**) or Tungsten 2 (**TU2**) finish.

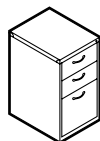

Box/Box/File Pedestal

EWPS19BBF	19 x 15 x 27.12	92.5	69	5.90	\$411
EWPS23BBF	23 x 15 x 27.12	92.5	75	7	\$425
EWPS29BBF	29 x 15 x 27.12	100	80	8.70	\$438

Two box and one file drawer pedestal. **Freestanding.** Soft touch Hytrel pull handles in Black (BLK) only. Lock mounted on the right hand side. One pencil tray and one plate divider included. Levelling glides are standard.

- MUST Specify Black (**BLK**) or Tungsten 2 (**TU2**) finish.

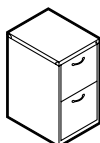

File/File Pedestal

EWPS19FF	19 x 15 x 27.12	92.5	69	5.90	\$411
EWPS23FF	23 x 15 x 27.12	92.5	75	7	\$425
EWPS29FF	29 x 15 x 27.12	100	80	8.70	\$438

Two file drawer pedestal. **Freestanding.** Soft touch Hytrel pull handles in Black (BLK) only. Lock mounted on the right hand side. Levelling glides are standard. Matches the height of two high lateral files.

- MUST Specify Black (**BLK**) or Tungsten 2 (**TU2**) finish.

PEDESTAL / FILE TOP SURFACES

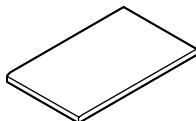

Pedestal Top Surface

EEP1915	19.62 x 15.25 x 1	70	13.40	.87	\$97
EEP2415	24 x 15.25 x 1	70	15.60	.87	\$97
EEP3015	30 x 15.25 x 1	65	24	1	\$159

e0+ laminate top surface for freestanding pedestal.

Required Specifications

Metal Finish
Laminate Finish (Pedestal Top Surface)

ECONOMY PERSONAL TOWERS



Personal Tower - 2 File Drawers

MODEL#	DIMENSIONS D x W x H	FREIGHT CLASS	WT./LBS.	CUBIC FT.	LIST PRICE
93PT-2FL	24 x 24 x 65.25	125	160	21.75	\$1500
93PT-2FR	24 x 24 x 65.25	125	160	21.75	\$1500

Ventilated wardrobe section, locker compartment and 2 file drawers. Looped full pull. 3 locks keyed alike. Locker compartment includes 2 shelves.

- MUST Specify Black (**BLK**) or Tungsten 2 (**TU2**) finish.
- Model 93PT-2FL has wardrobe section on the left and file drawers on the right.
- Model 93PT-2FR has wardrobe section on the right and file drawers on the left.

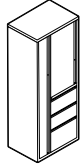

Personal Tower - 2 Box/1 File Drawers

93PT-2BFL	24 x 24 x 65.25	125	165	21.75	\$1500
93PT-2BFR	24 x 24 x 65.25	125	165	21.75	\$1500

Ventilated wardrobe section, locker compartment and 2 box and 1 file drawers. Looped full pull. 3 locks keyed alike. Locker compartment includes 2 shelves.

- MUST Specify Black (**BLK**) or Tungsten 2 (**TU2**) finish.
- Model 93PT-2BFL has wardrobe section on the left and file drawers on the right.
- Model 93PT-2BFR has wardrobe section on the right and file drawers on the left.

OVERHEAD STORAGE

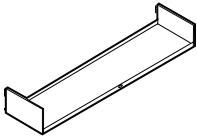

12" Deep Low Profile Shelf

ECOL1224	12 x 24 x 5	125	5.20	.83	\$87
ECOL1230	12 x 30 x 5	125	6.60	1.04	\$91
ECOL1236	12 x 36 x 5	125	7.90	1.25	\$96
ECOL1242	12 x 42 x 5	125	9.30	1.45	\$106
ECOL1248	12 x 48 x 5	125	10.60	1.66	\$121
ECOL1254	12 x 54 x 5	125	12.10	1.99	\$123
ECOL1260	12 x 60 x 5	125	13.20	2.08	\$134

Panel-mounted storage shelf with back lip that protects fabric. Includes all attachment hardware.

- MUST Specify Black (**BLK**) or Tungsten 2 (**TU2**) finish.

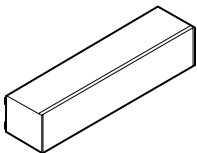

12" Deep Overhead with Receding Door

ECOF1224	12 x 24 x 14.5	60	27	.79	\$338
ECOF1230	12 x 30 x 14.5	60	31	.83	\$338
ECOF1236	12 x 36 x 14.5	60	36	.99	\$352
ECOF1242	12 x 42 x 14.5	60	41	1.16	\$381
ECOF1248	12 x 48 x 14.5	60	51	1.32	\$409
ECOF1254	12 x 54 x 14.5	60	53	1.66	\$431
ECOF1260	12 x 60 x 14.5	60	56	1.66	\$453

Door retracts up and over the cabinet. Inside dimensions - 12"h x 11 3/4"d. Lock not included. 60" unit is reinforced for proper weight distribution.

- MUST Specify Black (**BLK**) or Tungsten 2 (**TU2**) finish.

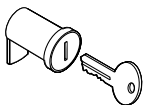

Locking Kit

ESLOCK	--	70	.01	.01	\$28
--------	----	----	-----	-----	-------------

For overhead flipper door storage cabinet. Includes two keys. Can only be field installed.

Required Specifications

Metal finish
Key #

DESK MOUNTED ACCESSORIES

MODEL#	DIMENSIONS	FREIGHT CLASS	WT/LBS.	CUBIC FT.	LIST PRICE
D x W x H					
PEEOCKS	18 x 18 x 1.12	70	6	.30	\$82

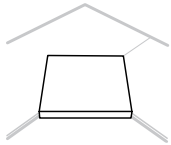
**Corner Keyboard Plate**

Connects two 1 1/8" worksurfaces that form a 90° corner into a 45° keyboard support corner surface.

- MUST Specify Black (**BLK**) or Tungsten 2 (**TU2**) finish.

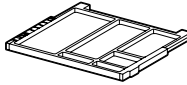
**Pencil Drawer**

PEEPD	15 x 22.5 x 1.5	250	2	.70	\$125
-------	-----------------	-----	---	-----	--------------

Provides storage for writing instruments and small items at the workspace. Attaches to the underside of the worksurface with included drawer slides.

- Black ABS plastic only

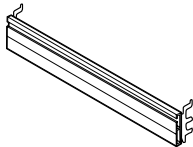
**Accessory Rail**

EARC24	.75 x 24 x 2	70	.98	.02	\$130
EARC30	.75 x 30 x 2	70	1.23	.03	\$137
EARC36	.75 x 36 x 2	70	1.43	.03	\$144
EARC42	.75 x 42 x 2	70	1.67	.04	\$153
EARC48	.75 x 48 x 2	70	1.91	.04	\$168
EARC54	.75 x 54 x 2	60	2	.05	\$184
EARC60	.75 x 60 x 2	60	2.39	.05	\$196

Extruded aluminum rail supports off-desk accessories. Attaches to panel edge using pre-installed brackets.

- MUST Specify Black (**BLK**) or Tungsten 2 (**TU2**) finish.

**Coat Hook**

EECTH	--	70	.01	.01	\$25
-------	----	----	-----	-----	-------------

Attaches to panel top.

- Pricing shown is for one piece.
- MUST Specify Black (**BLK**) or Tungsten 2 (**TU2**) finish.

ACCESSORY RAIL ORGANIZERS

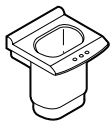
**Pencil Holder**

EEPH	3.75 x 4.25 x 4.5	70	.20	.58	\$16
------	-------------------	----	-----	-----	-------------

Mounts on the off-desk accessory rail. ABS plastic.

- MUST Specify Black (**BLK**) or Frosted (**FR**) finish.

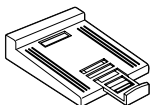
**Phone Support**

EEPS	10 x 8.5 x 2	70	.60	.12	\$40
------	--------------	----	-----	-----	-------------

Telephone tray. Mounts on the off-desk or panel accessory rail. ABS plastic.

- MUST Specify Black (**BLK**) or Frosted (**FR**) finish.

Required Specifications

Metal Finish

ACCESSORY RAIL ORGANIZERS

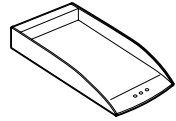

Paper Tray

MODEL#	DIMENSIONS D x W x H	FREIGHT CLASS	WT./LBS.	CUBIC FT.	LIST PRICE
EEPT	14 x 9.5 x 2	70	.90	.18	\$46

Mounts on the off-desk accessory rail. ABS plastic.
 • MUST Specify Black (**BLK**) or Frosted (**FR**) finish.

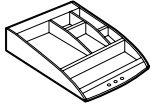

Organizer Tray

EEOT	10.25 x 9.5 x 2	70	.60	.13	\$41
------	-----------------	----	-----	-----	-------------

Mounts on the off-desk accessory rail. ABS plastic.
 • MUST Specify Black (**BLK**) or Frosted (**FR**) finish.

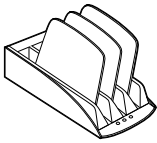

Slanted File Holder

EESFH	12.5 x 7.25 x 7	70	1.10	.15	\$60
-------	-----------------	----	------	-----	-------------

Mounts on the off-desk accessory rail. ABS plastic.
 • MUST Specify Black (**BLK**) or Frosted (**FR**) finish.

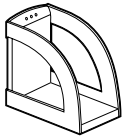

Binder Holder

EEBH	10.5 x 5 x 9	70	.50	.34	\$37
------	--------------	----	-----	-----	-------------

Mounts on the off-desk accessory rail. ABS plastic.
 • MUST Specify Black (**BLK**) or Frosted (**FR**) finish.

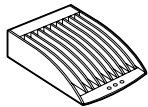

CD Holder

EECH	7.5 x 5.5 x 2	70	.50	.55	\$31
------	---------------	----	-----	-----	-------------

Mounts on the off-desk accessory rail. ABS plastic.
 • MUST Specify Black (**BLK**) or Frosted (**FR**) finish.

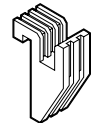

Accessory Clip

EEAH	--	70	.01	.10	\$4
------	----	----	-----	-----	------------

Attaches off-desk accessories to rail. Included with all accessory rail organizers. ABS plastic.
 • MUST Specify Black (**BLK**) or Frosted (**FR**) finish.

Required Specifications
 Finish

FREESTANDING COMPONENTS



Whiteboard Easel

MODEL#	DIMENSIONS	FREIGHT CLASS	WT./LBS.	CUBIC FT.	LIST PRICE
	D x W x H				
PEESL29	25 x 29 x 65.5	100	53	5.40	\$696
PEESL36	25 x 36 x 65.5	92.5	60	5.40	\$910

ELECTRICAL COMPONENTS

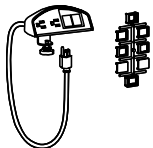

Adapt Power/Data Module

PEUEDM	4 x 6.5 x 2.5	92.5	2	.18	\$247
--------	---------------	------	---	-----	--------------

Includes two electrical outlets, spaces for two plugs with adaptors and a 6' power cord.

- Available in Black only.

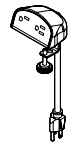

Mini-Adapt Power Module

PEUTEM	3 x 3.8 x 2	70	1	.18	\$159
--------	-------------	----	---	-----	--------------

Attaches to scoop, spaces for two plugs with adaptors and a 6' power cord. Data plugs not provided.

- Available in Black only.



Mini-Adapt Data Module

PEUTDM	3 x 3.75 x 2	92.5	2	.18	\$134
--------	--------------	------	---	-----	--------------

Includes two electrical outlets, spaces for two plugs with adaptors and a 6' power cord.

- Available in Black only.



Panel Mount Power Bar

EPMAWPB30	5.5 x 30 x 4	70	8	.50	\$458
EPMAWPB36	5.5 x 36 x 4	70	10	.50	\$471
EPMAWPB42	5.5 x 42 x 4	70	12	.70	\$475
EPMAWPB48	5.5 x 48 x 4	70	15	.70	\$481

Includes four receptacles, two data jack adapters, two cord management channels, sliding bracket and bezel tree. 6' cord.

- Available in Black only.

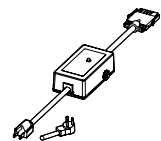

Power Cable

EIPEC	6.5 x 4.5 x 10.25	70	1	.18	\$376
-------	-------------------	----	---	-----	--------------





Interconnecting power entry cable, 15' long cord. Connects up to 8 monuments.

- Available in Black only.

Required Specifications

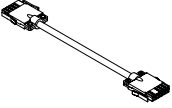
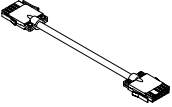
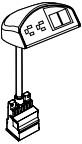
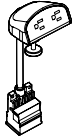
Finish - Whiteboard Easel

ELECTRICAL COMPONENTS

	MODEL#	DIMENSIONS D x W x H	FREIGHT CLASS	WT/LBS.	CUBIC FT.	LIST PRICE
	EITTTJC74	5 x 3 x 1	70	1	.10	\$137
Jumper Cable	Interconnecting table to table jumper cable, 74" long cord . • Available in Black only.					
	EITTTJC96	5 x 3 x 1	70	1.30	.10	\$151
Jumper Cable	Interconnecting table to table jumper cable, 96" long cord . • Available in Black only.					
	EIEDM	4 x 6.5 x 2.5	85	2.20	.18	\$267
Interconnecting Electrical/Data Monument	Attaches to scoop. Includes two electrical outlets and a space for two data plugs. • Available in Black only.					
	EIEM	3 x 3.8 x 2	70	1	.18	\$179
Interconnecting Electrical Monument	Attaches to scoop. Includes two electrical outlets. • Available in Black only.					
	ECCCCO	.5 x 20 x .5	70	1	.10	\$17
Cord Cover	For closed overhead to worksurface. • MUST Specify Black (BLK) or Tungsten 2 (TU2) finish.					
	ECCCOS	.5 x 16 x .5	70	1	.10	\$17
Cord Cover	For open shelving to worksurface. • MUST Specify Black (BLK) or Tungsten 2 (TU2) finish.					
	ECCWS	.5 x 24 x .5	70	1	.10	\$18
Cord Cover	For underside of worksurface to bottom panel . • MUST Specify Black (BLK) or Tungsten 2 (TU2) finish.					

Required Specifications
Finish

ELECTRICAL COMPONENTS

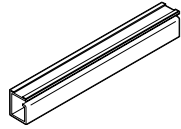
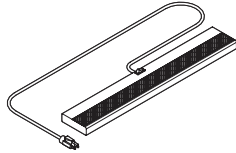
**Wire Manager****Task Light**

MODEL#	DIMENSIONS	FREIGHT CLASS	WT/LBS.	CUBIC FT.	LIST PRICE
--------	------------	---------------	---------	-----------	------------

D x W x H

PEWM1	2 x 12 x 2	70	.20	.10	\$27
PEWM1.5	2 x 18 x 2	70	.20	.10	\$37
PEWM2	2 x 24 x 2	70	.30	.10	\$50
PEWM2.5	2 x 30 x 2	70	.30	.10	\$60
PEWM3	2 x 36 x 2	70	.40	.10	\$73
PEWM3.5	2 x 42 x 2	70	.40	.10	\$83
PEWM4	2 x 48 x 2	70	.50	.10	\$96
PEWM4.5	2 x 54 x 2	70	.50	.10	\$106
PEWM5	2 x 60 x 2	70	.60	.10	\$119
PEWM5.5	2 x 66 x 2	70	.60	.10	\$142

Plastic tray flexes to receive and then hold electrical and data wires. Attaches with two strips of premium 3M two sided tape.

- Available in Black only.

PVET5L48	4.25 x 48 x 1.25	65	8	.28	\$175
PVET5L36	4.25 x 36 x 1.25	65	6	.21	\$158
PVET5L24	4.25 x 24 x 1.25	65	4	.15	\$146
PVET5L18	4.25 x 19.5 x 1.25	65	3	.12	\$140

T5 rapid start fluorescent lamp provides energy-efficient illumination. Slim low profile metal chassis. Electronic ballast. Prismatic acrylic lens included. Attaches to wood or metal units. 9' power cord. Specify 6" shorter than storage unit width.

- When hanging task lights on the underside of steel hutches, the **SHTSLB1** bracket set MUST BE USED.

Replacement bulbs for the task light are as follows:

24" - 14W T5 22" soft white

36" - 21W T5 34" soft white

48" - 28W T5 46" neutral



Divide is a modular desk-mounted panel system that can be retro installed on many Global Desks. The panels can be vertically stacked to provide varying degrees of privacy. The panels are available in laminate or fabric tackboards as well as glazed panels that allow light to pass through. Divide's off-desk accessories help to organize paperwork and free up the workspace. Divide is offered in many laminate and fabric color options to complement any office environment.



Features and Benefits

- Available as Fabric, Glazed or Laminate partitioning panels in an array of heights and widths
- Easy to specify: choose the desired panel height and width and its corresponding height divider post(s)
- A built-in accessory management rail (on fabric and glazed panels) is designed to accommodate off-desk accessories for workspace organization.
- Laminate panels offer an optional wire access cutout at the bottom of each panel (order as SCP2)
- Laminate Transaction Tops are offered in various shapes and sizes, and are standard as either 1" thick or 1½" thick to match
- All Adaptabilities, Correlation, Genoa, Halton and Zira laminate colors are offered as well as a wide variety of fabrics

GENERAL INFORMATION

- Divide is a desk-mounted panel system that can be field installed at any time on many Global desks
- Vertical stacking of varying heights provide semi-private to private work areas
- Panels are available in 12", 18", 24" and 36" heights and can be stacked to produce heights of 12", 18", 24", 30", 36" and 42" for a virtually limitless variety of configurations
- Progressive, desk-mounted partition system consisting of three major categories:
 - Divider Posts - to support the partitions
 - Partitioning Screens - a variety of widths and heights to create personalized privacy; offered in laminate, glaze or select fabrics
 - Transaction Tops - laminate tops ideal for creating reception stations
- Designed for use on the **Adaptabilities, Correlation, Genoa, Halton, and Zira** laminate desk series', and may be retrofitted onto non-Global square edged product if necessary.
- Global laminate and seating products are in compliance with stringent emission guidelines set out by the Greenguard Environmental Institute under the standards for low emitting products and materials. www.greenguard.org
- **Level 3 Certified**

DIVIDER POSTS

- Available in 6 standard heights:
 - 12" high - to create **semi-private** spaces and to support Transaction Tops
 - 18" high - to create **semi-private** spaces and to support Transaction Tops
 - 24" high - to create **semi-private** spaces
 - 30" high - to create **semi-private** spaces
 - 36" high - to create **private** spaces and to match the height of 36" high hutches and/or 65" high Adaptabilities, Genoa and Zira cabinets
 - 42" high - to create **private** spaces and to match the height of 42" high hutches and/or 72" high Correlation and Zira cabinets
- Posts are field installed. Each Divider Plate includes: 1 Post Mounting Plate, 1 Threaded Rod, 3 Cover Strips and 1 Top Cap plus Mounting Hardware (contains 8 screws, 1 washer, 1 locking nut). 2 Divider Posts are required per partitioning panel.
- Available in Black (**BK**) or Silver (**SI**) finish, please specify.

PARTITIONING SCREENS

- Available in 4 standard heights: 12", 18", 24" and 36" and can be used in combinations to create systems consisting of 12", 18", 24", 30", 36" and 42" heights.
- Available in 3 materials:
 - **Laminate** - available in all laminate colors used on Adaptabilities, Correlation, Genoa, Halton and Zira (see below). Standard black accent edging at top and bottom. Optional wire access scoop cut-out is offered, centered at the bottom of the panel - order as "**SCP2**" after model #.
 - **Glazed** - choice of **clear, ribbed or frosted** glazing. Top and bottom rail standard in Black (**BK**) or Silver (**SI**), please specify. Top rail is designed to accommodate off-desk accessories.
 - **Fabric** - available in all Grade 1, 2, 3 and 4 panel fabrics and select Grade 1, 2, 3 and 4 seating fabrics (see next page). Top and bottom rail standard in Black (**BK**) or Silver (**SI**), please specify. Top rail is designed to accommodate off-desk accessories.

TRANSACTION TOPS

- Tops are available in 1" or 1.5" thick thermally fused laminate
- Tops are sealed with Global's preferred edging in matching color
- Transaction Tops are available with optional edges at no upcharge. Please Specify:



A3 1" top, standard



AR 1" top, bicut edge



C3 1.5" top, standard



CR 1.5" top, bicut edge



CF 1.5" top, fluted edge

- All 1" thick transaction tops are available in all Adaptabilities, Correlation, Genoa, Halton and Zira laminate colors (see below). 1½" thick transaction tops are offered in Correlation and Zira laminate finishes only.
- Includes all necessary flat mounting plates and joining plates.
- Features pre-drilled locating holes to allow for quick alignment with the Divider Post.
- Available with a radius cut on one or both ends (each radius adds a 6" overhang).
- Woodgrain surfaces feature edging with matching printed woodgrain

LAMINATE AND EDGE FINISHES (laminate panels and transaction tops)

ACJ	Absolute Acajou	ASN	Asian Night
AWC	Avant Cherry	AWH	Avant Honey
BLK	Black	BRC	Brushed Cobalt
CSJ	Constellation Java	DES	Dark Espresso
GRY	Grey	HGT	Hayden Grey
QTM	Quartered Mahogany	SKC	Shaker Cherry
SOG	Storm Grey	TFW	Tiger Fruitwood
TMA	Tiger Mahogany	TMP	Tiger Maple
TWL	Tiger Walnut	WHT	White
WHC	White Chocolate*	WGY	Willow Grey
WCR	Winter Cherry		

*textured, HP non-textured, top only

FABRICS (fabric screens)

- Grade 1:** Agate II
- Grade 2:** Drama, Jenny, Lola, Pebbles, Quilt, Sprinkle, Station, Urban
- Grade 3:** Brinx, Crescent, Cumulus, Imprint, Mariposa, Match, Oxygen, Quantum, Renewal, Replay, Silhouette
- Grade 4:** Accent, Couture
- Momentum Grade 5:** Meander, Tracery and Universe (*extended lead time*)

D DIVIDE™ - NOTES

PLEASE NOTE:

- Divide screens cannot be centered between two back to back worksurfaces. Screens must be installed on one worksurface or the other. Divide cannot be used with Adaptabilities or Correlation reception units.

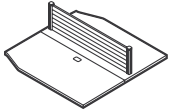

Correct Installation

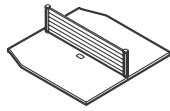

Incorrect Installation

HOW TO ORDER DIVIDE SCREENS

example: DTB 1236 GN31

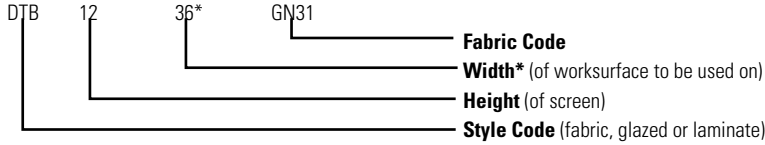

*NOTE: Number denotes width of worksurface to use - please see dimensions in price book for actual dimensions of the screen.

PARTS AND COMPONENTS

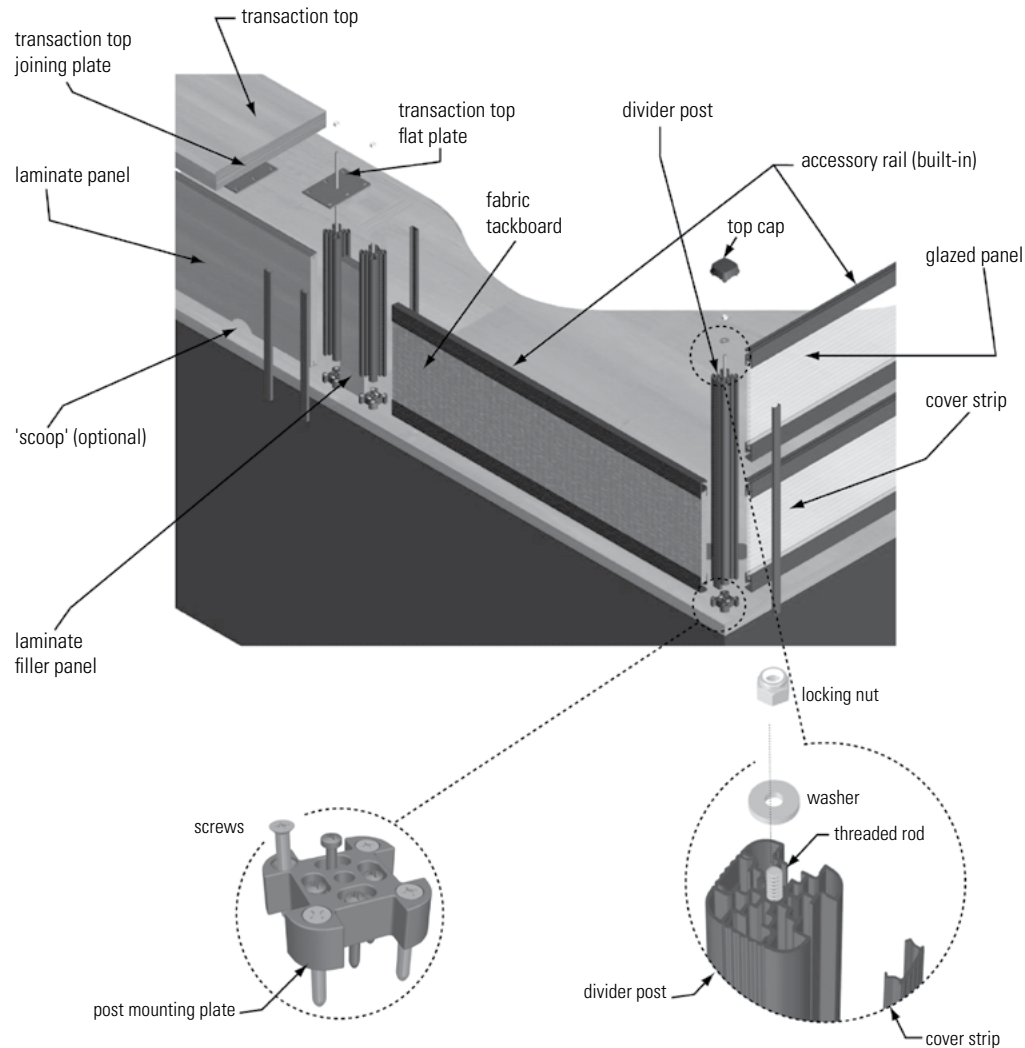

INSTALLATION IS AS SIMPLE AS 1...2...3

- 1) Attach the threaded **Post Mounting Plate** with enclosed screws to the top side of the worksurface.
- 2) **Divider Post** is bolted to the Mounting Plate.
- 3) **Top Cap** is attached to the top of the Divider Post.

12" High System

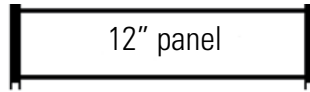

18" High System



24" High System

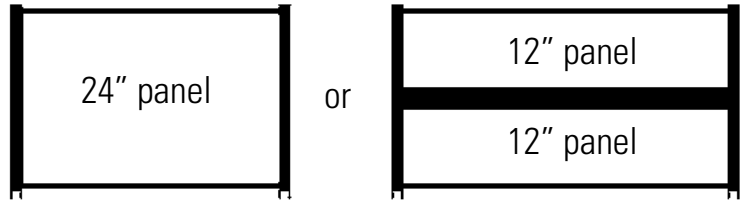

30" High System

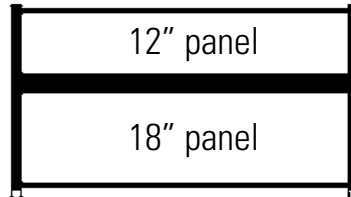

36" High System



42" High System

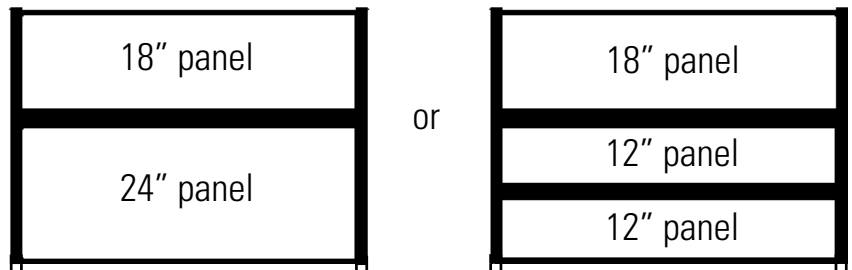

FABRIC PANELS

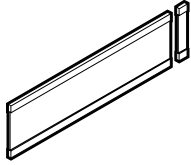

Fabric Panel - 12" High

MODEL#	DIMENSIONS D x W x H	FREIGHT CLASS	WT/LBS.	CUBIC FT.	GR. 1	GR. 2	GR. 3	GR. 4	GR. 5
DTB1220	.68 x 20 x 12	92.5	3	.30	\$189	\$210	\$228	\$256	\$293
DTB1224	.68 x 24 x 12	85	4	.30	\$198	\$219	\$236	\$262	\$300
DTB1229	.68 x 29 x 12	92.5	4	.40	\$209	\$233	\$248	\$276	\$312
DTB1230	.68 x 30 x 12	85	5	.40	\$209	\$233	\$248	\$276	\$312
DTB1236	.68 x 36 x 12	85	5	.40	\$233	\$255	\$271	\$298	\$334
DTB1242	.68 x 42 x 12	85	6	.50	\$271	\$293	\$309	\$335	\$373
DTB1248	.68 x 48 x 12	92.5	7	.60	\$294	\$314	\$332	\$357	\$395
DTB1260	.68 x 60 x 12	85	9	.70	\$314	\$336	\$353	\$380	\$417
DTB1266	.68 x 66 x 12	85	10	.80	\$333	\$354	\$372	\$398	\$435
DTB1272	.68 x 72 x 12	85	11	.80	\$354	\$376	\$393	\$419	\$456

Features built-in accessory rail. Includes matching filler panel. Ships 1 set per carton. **Specify DTB1229 for panels placed along the depth side of a 30" deep worksurface. Top and bottom rail are offered in Black (BK) or Silver (SI), please specify.**

- Model # depicts size of worksurface to be used on - see NOTES on pg. 476 for additional ordering information.
- When specifying a Grade 1, 2, 3, 4 or 5 seating fabric, please note fabric pattern will run horizontally
- Divider Post **MUST** be ordered separately. Two posts are required per panel.

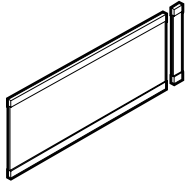

Fabric Panel - 18" High

DTB1820	.68 x 20 x 18	85	4	.30	\$209	\$233	\$248	\$276	\$312
DTB1824	.68 x 24 x 18	85	5	.40	\$221	\$241	\$259	\$284	\$322
DTB1829	.68 x 29 x 18	85	6	.50	\$233	\$255	\$271	\$298	\$334
DTB1830	.68 x 30 x 18	85	6	.50	\$233	\$255	\$271	\$298	\$334
DTB1836	.68 x 36 x 18	92.5	7	.60	\$271	\$293	\$309	\$335	\$373
DTB1842	.68 x 42 x 18	92.5	8	.70	\$296	\$317	\$333	\$359	\$396
DTB1848	.68 x 48 x 18	85	10	.80	\$314	\$336	\$353	\$380	\$417
DTB1860	.68 x 60 x 18	85	12	.90	\$333	\$354	\$372	\$398	\$435
DTB1866	.68 x 66 x 18	85	14	1	\$354	\$376	\$393	\$419	\$456
DTB1872	.68 x 72 x 18	85	14	1.10	\$396	\$418	\$435	\$462	\$499

Features built-in accessory rail. Includes matching filler panel. Ships 1 set per carton. **Specify DTB1829 for panels placed along the depth side of a 30" deep worksurface. Top and bottom rail are offered in Black (BK) or Silver (SI), please specify.**

- Model # depicts size of worksurface to be used on - see NOTES on pg. 476 for additional ordering information.
- When specifying a Grade 1, 2, 3, 4 or 5 seating fabric, please note fabric pattern will run horizontally
- Divider Post **MUST** be ordered separately. Two posts are required per panel.

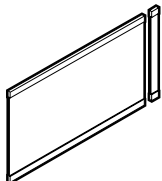

Fabric Panel - 24" High

DTB2420	.68 x 20 x 24	92.5	4	.40	\$233	\$255	\$271	\$298	\$334
DTB2424	.68 x 24 x 24	100	4	.50	\$233	\$255	\$271	\$298	\$334
DTB2429	.68 x 29 x 24	92.5	6	.60	\$271	\$293	\$309	\$335	\$373
DTB2430	.68 x 30 x 24	92.5	6	.60	\$271	\$293	\$309	\$335	\$373
DTB2436	.68 x 36 x 24	92.5	7	.70	\$294	\$314	\$332	\$357	\$395
DTB2442	.68 x 42 x 24	92.5	8	.80	\$314	\$336	\$353	\$380	\$417
DTB2448	.68 x 48 x 24	92.5	9	.90	\$333	\$354	\$372	\$398	\$435
DTB2460	.68 x 60 x 24	92.5	11	1.10	\$354	\$376	\$393	\$419	\$456
DTB2466	.68 x 66 x 24	92.5	12	1.20	\$396	\$418	\$435	\$462	\$499
DTB2472	.68 x 72 x 24	92.5	14	1.40	\$431	\$453	\$471	\$496	\$534

Features built-in accessory rail. Includes matching filler panel. Ships 1 set per carton. **Specify DTB2429 for panels placed along the depth side of a 30" deep worksurface. Top and bottom rail are offered in Black (BK) or Silver (SI), please specify.**

- Model # depicts size of worksurface to be used on - see NOTES on pg. 476 for additional ordering information.
- When specifying a Grade 1, 2, 3, 4 or 5 seating fabric, please note fabric pattern will run horizontally
- Divider Post **MUST** be ordered separately. Two posts are required per panel.

Required Specifications

- Fabric
- Rail Finish

FABRIC PANELS

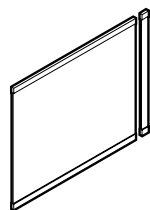

Fabric Panel - 36" High

MODEL#	DIMENSIONS	FREIGHT CLASS	WT/LBS.	CUBIC FT.	GR. 1	GR. 2	GR. 3	GR. 4	GR. 5
D x W x H									
DTB3620	.68 x 20 x 36	92.5	6	.60	\$271	\$293	\$309	\$335	\$373
DTB3624	.68 x 24 x 36	92.5	7	.70	\$280	\$302	\$319	\$345	\$382
DTB3629	.68 x 29 x 36	92.5	9	.90	\$294	\$314	\$332	\$357	\$395
DTB3630	.68 x 30 x 36	92.5	9	.90	\$294	\$314	\$332	\$357	\$395
DTB3636	.68 x 36 x 36	92.5	10	1	\$314	\$336	\$353	\$380	\$417
DTB3642	.68 x 42 x 36	92.5	12	1.20	\$333	\$354	\$372	\$398	\$435
DTB3648	.68 x 48 x 36	92.5	14	1.30	\$354	\$376	\$393	\$419	\$456
DTB3660	.68 x 60 x 36	92.5	17	1.60	\$396	\$418	\$435	\$462	\$499
DTB3666	.68 x 66 x 36	92.5	19	1.80	\$431	\$453	\$471	\$496	\$534
DTB3672	.68 x 72 x 36	92.5	21	1.90	\$466	\$488	\$503	\$530	\$567

Features built-in accessory rail. Includes matching filler panel. Ships 1 set per carton. **Specify DTB3629 for panels placed along the depth side of a 30" deep worksurface. Top and bottom rail are offered in Black (BK) or Silver (SI), please specify.**

- Model # depicts size of worksurface to be used on - see NOTES on pg. 476 for additional ordering information.
- When specifying a Grade 1, 2, 3, 4 or 5 seating fabric, please note fabric pattern will run horizontally
- Divider Post **MUST** be ordered separately. Two posts are required per panel.

GLAZED PANELS

LIST PRICE

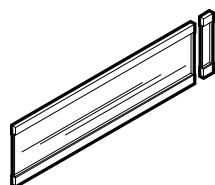

Glazed Panel - 12" High

DGP1220	.68 x 20 x 12	125	2	.30	\$187
DGP1224	.68 x 24 x 12	92.5	3	.30	\$198
DGP1229	.68 x 29 x 12	125	3	.40	\$235
DGP1230	.68 x 30 x 12	92.5	4	.40	\$235
DGP1236	.68 x 36 x 12	92.5	4	.40	\$273
DGP1242	.68 x 42 x 12	92.5	5	.50	\$311
DGP1248	.68 x 48 x 12	100	5	.60	\$367
DGP1260	.68 x 60 x 12	92.5	7	.70	\$431
DGP1266	.68 x 66 x 12	100	7	.80	\$472
DGP1272	.68 x 72 x 12	92.5	8	.80	\$511

Features built-in accessory rail. Includes matching filler panel. Ships 1 set per carton. **Specify DGP1229 for panels placed along the depth side of a 30" deep worksurface. Top and bottom rail are offered in Black (BK) or Silver (SI), please specify.**

- Model # depicts size of worksurface to be used on - see NOTES on pg. 476 for additional ordering information.
- Divider Post **MUST** be ordered separately. Two posts are required per panel.
- Glazing is available in Frosted (GF), Clear (GC) or Ribbed (RG).

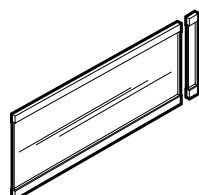

Glazed Panel - 18" High

DGP1820	.68 x 20 x 18	92.5	3	.30	\$207
DGP1824	.68 x 24 x 18	125	3	.40	\$225
DGP1829	.68 x 29 x 18	100	4	.50	\$263
DGP1830	.68 x 30 x 18	100	4	.50	\$263
DGP1836	.68 x 36 x 18	100	5	.60	\$304
DGP1842	.68 x 42 x 18	125	5	.70	\$339
DGP1848	.68 x 48 x 18	125	6	.80	\$408
DGP1860	.68 x 60 x 18	100	8	.90	\$487
DGP1866	.68 x 66 x 18	100	8	1	\$527
DGP1872	.68 x 72 x 18	100	9	1.10	\$570

Features built-in accessory rail. Includes matching filler panel. Ships 1 set per carton. **Specify DGP1829 for panels placed along the depth side of a 30" deep worksurface. Top and bottom rail are offered in Black (BK) or Silver (SI), please specify.**

- Model # depicts size of worksurface to be used on - see NOTES on pg. 476 for additional ordering information.
- Divider Post **MUST** be ordered separately. Two posts are required per panel.
- Glazing is available in Frosted (GF), Clear (GC) or Ribbed (RG).

Required Specifications

Fabric (Fabric Panels)
 Glaze (Glazed Panels)
 Rail Finish

GLAZED PANELS

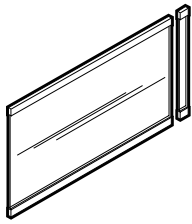

Glazed Panel - 24" High

MODEL#	DIMENSIONS D x W x H	FREIGHT CLASS	WT./LBS.	CUBIC FT.	LIST PRICE
DGP2420	.68 x 20 x 24	125	3	.40	\$225
DGP2424	.68 x 24 x 24	100	4	.50	\$252
DGP2429	.68 x 29 x 24	125	4	.60	\$302
DGP2430	.68 x 30 x 24	100	5	.60	\$302
DGP2436	.68 x 36 x 24	125	5	.70	\$349
DGP2442	.68 x 42 x 24	125	6	.80	\$396
DGP2448	.68 x 48 x 24	125	7	.90	\$466
DGP2460	.68 x 60 x 24	100	9	1.10	\$566
DGP2466	.68 x 66 x 24	100	10	1.20	\$617
DGP2472	.68 x 72 x 24	125	10	1.40	\$665

Features built-in accessory rail. Includes matching filler panel. Ships 1 set per carton. **Specify DGP2429 for panels placed along the depth side of a 30" deep worksurface. Top and bottom rail are offered in Black (BK) or Silver (SI), please specify.**

- Model # depicts size of worksurface to be used on - see NOTES on pg. 476 for additional ordering information.
- Divider Post **MUST** be ordered separately. Two posts are required per panel.
- Glazing is available in Frosted (GF), Clear (GC) or Ribbed (RG).

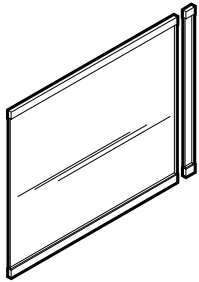

Glazed Panel - 36" High

DGP3620	.68 x 20 x 36	125	4	.60	\$273
DGP3624	.68 x 24 x 36	150	4	.70	\$302
DGP3629	.68 x 29 x 36	150	5	.90	\$361
DGP3630	.68 x 30 x 36	125	6	.90	\$361
DGP3636	.68 x 36 x 36	125	7	1	\$427
DGP3642	.68 x 42 x 36	125	8	1.20	\$487
DGP3648	.68 x 48 x 36	125	9	1.30	\$570
DGP3660	.68 x 60 x 36	125	11	1.60	\$688
DGP3666	.68 x 66 x 36	125	12	1.80	\$750
DGP3672	.68 x 72 x 36	125	13	1.90	\$810

Features built-in accessory rail. Includes matching filler panel. Ships 1 set per carton. **Specify DGP3629 for panels placed along the depth side of a 30" deep worksurface. Top and bottom rail are offered in Black (BK) or Silver (SI), please specify.**

- Model # depicts size of worksurface to be used on - see NOTES on pg. 476 for additional ordering information.
- Divider Post **MUST** be ordered separately. Two posts are required per panel.
- Glazing is available in Frosted (GF), Clear (GC) or Ribbed (RG).

LAMINATE PANELS

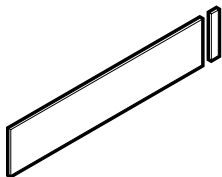

Laminate Panel - 12" High

DLP1220	.68 x 20 x 12	70	5	.30	\$61
DLP1224	.68 x 24 x 12	70	5	.30	\$70
DLP1229	.68 x 29 x 12	70	7	.40	\$91
DLP1230	.68 x 30 x 12	70	7	.40	\$91
DLP1236	.68 x 36 x 12	70	8	.40	\$100
DLP1242	.68 x 42 x 12	70	10	.50	\$114
DLP1248	.68 x 48 x 12	70	11	.60	\$129
DLP1260	.68 x 60 x 12	70	14	.70	\$138
DLP1266	.68 x 66 x 12	70	16	.80	\$153
DLP1272	.68 x 72 x 12	70	17	.80	\$172

Includes matching filler panel. Scoop option (SCP2) available, **ADD \$31.00**. Ships 1 set per carton. **Specify DLP1229 for panels placed along the depth side of a 30" deep worksurface.**

- Model # depicts size of worksurface to be used on - see NOTES on pg. 476 for additional ordering information.
- Divider Post **MUST** be ordered separately. Two posts are required per panel.

Required Specifications

- Glaze (Glazed Panels)
- Finish (Laminate Panels)
- Rail Finish (glazed panels)

LAMINATE PANELS

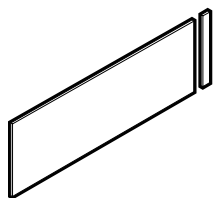

Laminate Panel - 18" High

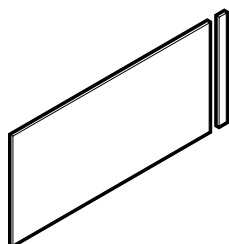

Laminate Panel - 24" High

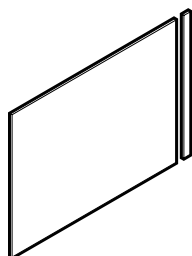

Laminate Panel - 36" High

MODEL#	DIMENSIONS	FREIGHT CLASS	WT/LBS.	CUBIC FT.	LIST PRICE
--------	------------	---------------	---------	-----------	------------

D x W x H					
DLP1820	.68 x 20 x 18	65	7	.30	\$72
DLP1824	.68 x 24 x 18	70	8	.40	\$83
DLP1829	.68 x 29 x 18	70	10	.50	\$98
DLP1830	.68 x 30 x 18	70	10	.50	\$98
DLP1836	.68 x 36 x 18	70	12	.60	\$112
DLP1842	.68 x 42 x 18	70	15	.70	\$129
DLP1848	.68 x 48 x 18	70	17	.80	\$149
DLP1860	.68 x 60 x 18	65	21	.90	\$162
DLP1866	.68 x 66 x 18	65	23	1	\$179
DLP1872	.68 x 72 x 18	65	25	1.10	\$198

Includes matching filler panel. Scoop option (SCP2) available, **ADD \$31.00**. Ships 1 set per carton. **Specify DLP1829 for panels placed along the depth side of a 30" deep worksurface.**

- Model # depicts size of worksurface to be used on - see NOTES on pg. 372 for additional ordering information.
- Divider Post **MUST** be ordered separately. Two posts are required per panel.

DLP2420	.68 x 20 x 24	65	9	.40	\$83
DLP2424	.68 x 24 x 24	70	11	.50	\$90
DLP2429	.68 x 29 x 24	70	13	.60	\$112
DLP2430	.68 x 30 x 24	70	13	.60	\$112
DLP2436	.68 x 36 x 24	65	16	.70	\$124
DLP2442	.68 x 42 x 24	65	19	.80	\$144
DLP2448	.68 x 48 x 24	65	22	.90	\$165
DLP2460	.68 x 60 x 24	65	28	1.10	\$187
DLP2466	.68 x 66 x 24	65	30	1.20	\$206
DLP2472	.68 x 72 x 24	65	33	1.40	\$227

Includes matching filler panel. Scoop option (SCP2) available, **ADD \$31.00**. Ships 1 set per carton. **Specify DLP2429 for panels placed along the depth side of a 30" deep worksurface.**

- Model # depicts size of worksurface to be used on - see NOTES on pg. 476 for additional ordering information.
- Divider Post **MUST** be ordered separately. Two posts are required per panel.

DLP3620	.68 x 20 x 36	70	13	.60	\$101
DLP3624	.68 x 24 x 36	65	16	.70	\$112
DLP3629	.68 x 29 x 36	70	20	.90	\$136
DLP3630	.68 x 30 x 36	70	20	.90	\$136
DLP3636	.68 x 36 x 36	65	24	1	\$160
DLP3642	.68 x 42 x 36	65	28	1.20	\$184
DLP3648	.68 x 48 x 36	65	33	1.30	\$206
DLP3660	.68 x 60 x 36	65	41	1.60	\$238
DLP3666	.68 x 66 x 36	65	45	1.80	\$263
DLP3672	.68 x 72 x 36	65	50	1.90	\$290

Includes matching filler panel. Scoop option (SCP2) available, **ADD \$31.00**. Ships 1 set per carton. **Specify DLP3629 for panels placed along the depth side of a 30" deep worksurface.**

- Model # depicts size of worksurface to be used on - see NOTES on pg. 476 for additional ordering information.
- Divider Post **MUST** be ordered separately. Two posts are required per panel.

Required Specifications

Finish

ACCESSORY RAIL ORGANIZERS



Pencil Holder

MODEL#	DIMENSIONS D x W x H	FREIGHT CLASS	WT/LBS.	CUBIC FT.	LIST PRICE
EEPH	3.75 x 4.25 x 4.5	70	.20	.58	\$16

Mounts on the off-desk accessory rail. ABS plastic.

- Cannot be used on Divide Laminate Panels
- MUST Specify Black (**BLK**) or Frosted (**FR**) finish.

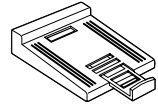

Phone Support

EEPS	10 x 8.5 x 2	70	.60	.12	\$40
------	--------------	----	-----	-----	-------------

Telephone tray. Mounts on the off-desk or panel accessory rail. ABS plastic.

- Cannot be used on Divide Laminate Panels
- MUST Specify Black (**BLK**) or Frosted (**FR**) finish.

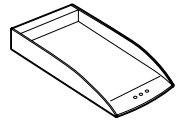

Paper Tray

EEPT	14 x 9.5 x 2	70	.90	.18	\$46
------	--------------	----	-----	-----	-------------

Mounts on the off-desk accessory rail. ABS plastic.

- Cannot be used on Divide Laminate Panels
- MUST Specify Black (**BLK**) or Frosted (**FR**) finish.

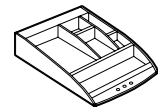

Organizer Tray

EEOT	10.25 x 9.5 x 2	70	.60	.13	\$41
------	-----------------	----	-----	-----	-------------

Mounts on the off-desk accessory rail. ABS plastic.

- Cannot be used on Divide Laminate Panels
- MUST Specify Black (**BLK**) or Frosted (**FR**) finish.

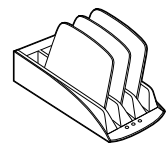

Slanted File Holder

EESFH	12.5 x 7.25 x 7	70	1.10	.15	\$60
-------	-----------------	----	------	-----	-------------

Mounts on the off-desk accessory rail. ABS plastic.

- Cannot be used on Divide Laminate Panels
- MUST Specify Black (**BLK**) or Frosted (**FR**) finish.

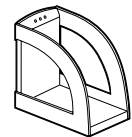

Binder Holder

EEBH	10.5 x 5 x 9	70	.50	.34	\$37
------	--------------	----	-----	-----	-------------

Mounts on the off-desk accessory rail. ABS plastic.

- Cannot be used on Divide Laminate Panels
- MUST Specify Black (**BLK**) or Frosted (**FR**) finish.

Required Specifications

Finish

ACCESSORY RAIL ORGANIZERS

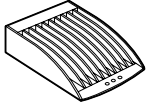

CD Holder

MODEL#	DIMENSIONS	FREIGHT CLASS	WT/LBS.	CUBIC FT.	LIST PRICE
D x W x H					
EECH	7.5 x 5.5 x 2	70	.50	.55	\$31

Mounts on the off-desk accessory rail. ABS plastic.

- Cannot be used on Divide Laminate Panels
- MUST Specify Black (**BLK**) or Frosted (**FR**) finish.

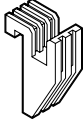

Accessory Clip

EEAH	--	70	.01	.10	\$4
------	----	----	-----	-----	------------

Attaches off-desk accessories to rail. Included with all accessory rail organizers. ABS plastic.

- Cannot be used on Divide Laminate Panels
- MUST Specify Black (**BLK**) or Frosted (**FR**) finish.

DIVIDER POSTS



Divider Post

DPOST12	1.68 x 1.68 x 12	70	2	.10	\$84
DPOST18	1.68 x 1.68 x 18	70	2	.10	\$114
DPOST24	1.68 x 1.68 x 24	60	3	.10	\$150
DPOST30	1.68 x 1.68 x 30	60	4	.10	\$207
DPOST36	1.68 x 1.68 x 36	70	4	.20	\$238
DPOST42	1.68 x 1.68 x 42	65	5	.20	\$266

For supporting panels. Includes one post mounting plate, one top cap, three cover strips, threaded rod and all mounting hardware. Installation templates are supplied with each project. Black (**BK**) or Silver (**SI**) - please specify.

- Requires 2 Divider Posts per panel
- Divider Post is mounted 1 1/16" from worksurface edge.



Post-to-Wall Filler Strip

DFS12	1.43 x .75 x 12	150	2	.50	\$45
DFS18	1.43 x .75 x 18	150	2	.50	\$45
DFS24	1.43 x .75 x 24	150	2	.50	\$45
DFS30	1.43 x .75 x 30	150	2	.50	\$48
DFS36	1.43 x .75 x 36	150	2	.50	\$48
DFS42	1.43 x .75 x 42	150	3	.60	\$48

Used to fill gap between Divider Post and an adjacent wall, wardrobe unit, or hutch. Ships 1 per carton. Black only.

Required Specifications

Finish

TRANSACTION TOPS

D x W x H

- To order a radius end on one side of a transaction top, add the suffix "D" to the model number (ex. DATT30D). Add a **15% upcharge**.
- To order a radius end on both sides of a transaction top, add the suffix "DD" to the model number (ex. DATT30DD). Add a **20% upcharge**.
- Each radius end adds a 6" overhang per side (see illustrations below).

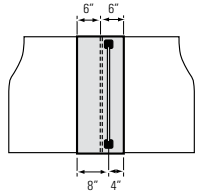

Transaction top is offset 6" from edge of worksurface in both directions.

Transaction top is offset 4" from the center of divider post towards the inside and 8" towards the outside.

Transaction Top Offset

- 4" from the center of the Divider Post to the inside of worksurface
- 8" from the center of the Divider Post to the outside of worksurface

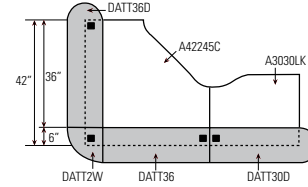

Two Way Connector Transaction Top (DATT2W/DCTT2W)

Use with a corner worksurface to link transaction tops together.

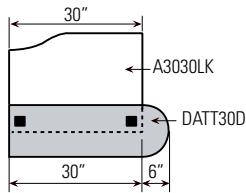

Radius End Transaction Top - one side

Add suffix "D" to model number for radius end on one side.

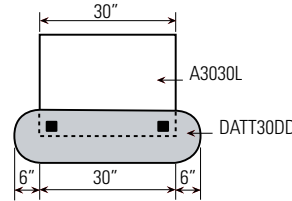

Radius End Transaction Top - two sides

Add suffix "DD" to model number for radius end on both sides.

STRAIGHT TRANSACTION TOPS



Straight Transaction Top - 1" thick

DATT14	12 x 14 x 1	65	7	.30	\$186
DATT18	12 x 18 x 1	70	8	.40	\$186
DATT20	12 x 20 x 1	70	9	.50	\$186
DATT23	12 x 23 x 1	70	10	.50	\$210
DATT24	12 x 24 x 1	70	10	.50	\$210
DATT29	12 x 29 x 1	70	12	.60	\$226
DATT30	12 x 30 x 1	70	12	.60	\$226
DATT36	12 x 36 x 1	70	14	.70	\$238
DATT42	12 x 42 x 1	70	16	.80	\$252
DATT48	12 x 48 x 1	70	18	.90	\$252
DATT54	12 x 54 x 1	70	21	1	\$285
DATT60	12 x 60 x 1	70	23	1.10	\$285
DATT66	12 x 66 x 1	70	25	1.20	\$318
DATT72	12 x 72 x 1	70	27	1.30	\$318

12" deep x 1" thick top. Includes all necessary Flat Plates, Joining Plates and screws. Thickness matches Adaptabilities, Genoa, Halton and Zira Series worksurfaces. Ships 1 set per carton.

- Add "D" to model number for radius end on one side, ADD **15% upcharge**.
- Add "DD" to model number for radius end on both sides, ADD **20% upcharge**.
- Each radius adds 6" overhang per side.

Required Specifications

Laminate Finish
Edge Detail

Optional Specifications

Radius End

PRIVACY PANELS

MODEL# DIMENSIONS FREIGHT CLASS WT/LBS. CUBIC FT. LIST PRICE

D x W x H

DCTT14	12 x 14 x 1.5	60	9	.30	\$258
DCTT18	12 x 18 x 1.5	65	11	.40	\$258
DCTT20	12 x 20 x 1.5	65	12	.50	\$258
DCTT23	12 x 23 x 1.5	65	14	.50	\$300
DCTT24	12 x 24 x 1.5	65	14	.50	\$300
DCTT29	12 x 29 x 1.5	65	17	.60	\$320
DCTT30	12 x 30 x 1.5	65	17	.60	\$320
DCTT36	12 x 36 x 1.5	65	20	.70	\$334
DCTT42	12 x 42 x 1.5	65	23	.80	\$334
DCTT48	12 x 48 x 1.5	65	26	.90	\$334
DCTT54	12 x 54 x 1.5	65	29	1	\$381
DCTT60	12 x 60 x 1.5	65	32	1.10	\$381
DCTT66	12 x 66 x 1.5	65	35	1.20	\$418
DCTT72	12 x 72 x 1.5	65	38	1.30	\$418



Straight Transaction Top - 1½" thick

12" deep x 1½" thick top. Includes all necessary Flat Plates, Joining Plates and screws. Thickness matches Correlation and Zira Series worksurfaces. Ships 1 set per carton.

- Add "D" to model number for radius end on one side, ADD **15% upcharge**.
- Add "DD" to model number for radius end on both sides, ADD **20% upcharge**.
- Each radius adds 6" overhang per side.

GALLERY CORNER TRANSACTION TOPS

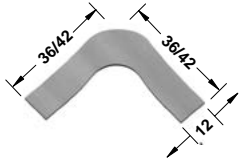

Gallery Corner Transaction Top - 1" thick

DA1GC36	36 x 36 x 1	125	32	5	\$569
DA1GC42	42 x 42 x 1	150	38	6.50	\$569

One piece corner top to be used on 36" and 42" 5-sided corners. Cut-out maximizes use of worksurface space allowing for computer screen. Includes all necessary Flat Plates, Joining Plates and screws. Thickness matches Adaptabilities, Genoa, Halton and Zira Series worksurfaces. Ships 1 set per carton.

- Woodgrain runs in one direction.

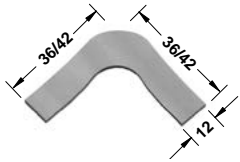

Gallery Corner Transaction Top - 1½" thick

DC1GC36	36 x 36 x 1.5	100	43	5	\$709
DC1GC42	42 x 42 x 1.5	125	50	6.50	\$709

One piece corner top to be used on 36" and 42" 5-sided corners. Cut-out maximizes use of worksurface space allowing for computer screen. Includes all necessary Flat Plates, Joining Plates and screws. Thickness matches Correlation and Zira Series worksurfaces. Ships 1 set per carton.

- Woodgrain runs in one direction.

2 PIECE GALLERY CORNER TRANSACTION TOPS



2 Piece Gallery Corner Transaction Top - 1" thick

DA2GC36	36 x 36 x 1	70	29	1.90	\$403
DA2GC42	42 x 42 x 1	70	33	1.90	\$403

Two piece corner top to be used on 36" and 42" 5-sided corners. Cut-out maximizes use of worksurface space allowing for computer screen. Includes all necessary Flat Plates, Joining Plates and screws. Thickness matches Adaptabilities, Genoa, Halton and Zira Series worksurfaces. Ships 1 set per carton.

- Woodgrain runs in two directions.

Required Specifications

Laminate Finish
Edge Detail

Optional Specifications

Radius End (DCTT models)

2 PIECE GALLERY CORNER TRANSACTION TOPS

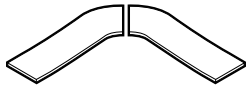

**2 Piece Gallery Corner
Transaction Top - 1½" thick**

MODEL#	DIMENSIONS D x W x H	FREIGHT CLASS	WT/LBS.	CUBIC FT.	LIST PRICE
DC2GC36	36 x 36 x 1.5	70	39	1.90	\$543
DC2GC42	42 x 42 x 1.5	65	45	1.90	\$543

Two piece corner top to be used on 36" and 42" 5-sided corners. Cut-out maximizes use of worksurface space allowing for computer screen. Includes all necessary Flat Plates, Joining Plates and screws. Thickness matches Correlation and Zira Series worksurfaces. Ships 1 set per carton.

- Woodgrain runs in two directions.

2-WAY CONNECTOR TRANSACTION TOPS



**2-Way Connector
Transaction Top - 1" thick**

DATT2W	12 x 12 x 1	70	6	.30	\$255
--------	-------------	----	---	-----	--------------

Used as a corner piece to link two transaction tops. Deduct 6" from each side adjoining the corner piece. Includes all necessary Flat Plates, Joining Plates and screws. Thickness matches Adaptabilities, Genoa, Halton and Zira Series worksurfaces. Ships 1 set per carton.

- Woodgrain runs diagonally.

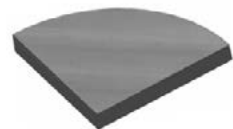

**2-Way Connector
Transaction Top - 1½" thick**

DCTT2W	12 x 12 x 1.5	65	7	.30	\$296
--------	---------------	----	---	-----	--------------

Used as a corner piece to link two transaction tops. Deduct 6" from each side adjoining the corner piece. Includes all necessary Flat Plates, Joining Plates and screws. Thickness matches Correlation and Zira Series worksurfaces. Ships 1 set per carton.

- Woodgrain runs diagonally.

4-WAY CONNECTOR TRANSACTION TOPS

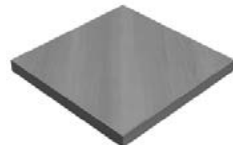

**4-Way Connector
Transaction Top - 1" thick**

DATT4W	12 x 12 x 1	65	8	.30	\$270
--------	-------------	----	---	-----	--------------

Used as a corner piece to link four transaction tops. Deduct 6" from each side adjoining the corner piece. Includes all necessary Flat Plates, Joining Plates and screws. Thickness matches Adaptabilities, Genoa, Halton and Zira Series worksurfaces. Ships 1 set per carton.

- Woodgrain runs diagonally.



**4-Way Connector
Transaction Top - 1½" thick**

DCTT4W	12 x 12 x 1.5	60	10	.30	\$348
--------	---------------	----	----	-----	--------------

Used as a corner piece to link four transaction tops. Deduct 6" from each side adjoining the corner piece. Includes all necessary Flat Plates, Joining Plates and screws. Thickness matches Correlation and Zira Series worksurfaces. Ships 1 set per carton.

- Woodgrain runs diagonally.

Required Specifications

Laminate Finish
Edge Detail

GENERAL INFORMATION

- GPS II is a MODULAR panel system that can be used with Adaptabilities, Correlation and Zira to address reception, privacy and/or storage needs.
- New painted frame finish matches metal seating finishes, available in four fabric grades.
- Global laminate and seating products are in compliance with stringent emission guidelines set out by the Greenguard Environmental Institute under the standards for low emitting products and materials. www.greenguard.org
- **Level 3 Certified**

CONSTRUCTION

- Stand alone panels are shipped with legs detached and neatly concealed inside frame for ease of cartoning and shipping. The legs simply slide into position on the job site for “no tools” installation.
- For fabric wrapped frames, specify “**FW**”, **ADD \$73** per panel. AGATE II panel fabric is not available for this option.
- Glazed panels are available in Clear (**GC**) and Smoked (**GS**) as standard. Frosted (**FZ**) glazing is available at a **10% upcharge**. Please specify at the time of order.
- Frame finishes are available in Black (**BK**), Business Grey (**BG**), Nevada (**NV**) or Chrome (**CH**). Please specify.
- Please Note: Free standing fabric panels (GPS1, GPS2, GPS3, GPS4, GPS5, GPS6, and GPS7) are available with a Chrome (CH) frame ONLY.
- 72” wide panels are upholstered horizontally due to the width of fabric rolls.
- All panels are built 3/8” wider than nominal width to allow for return panel installation. **All “special width” panels must be ordered 3/8” less than actual width required.**
- Panel ‘creepage’ will occur on long straight runs.
- It is recommended that panel runs do not exceed 8 feet in length without additional panel support and hardware.
- The bottom edge of the plexiglass window is 42” off the floor for partially glazed and 7” for fully glazed panels.
- NRC rating of 0.4.
- Straight panels have two adjustable levelling glides (finished in black), curved panels have three. Glides can be replaced with optional self-supporting feet.
- All panel connectors (finished in black) must be ordered separately.
- All panels are shipped one per carton.
- For **custom** sizes, take the next larger size **fabric** panel and **ADD 10%**.
- For **glazed** panels, take the next larger size panel and **ADD 15%**.

PANEL FABRICS

- C.O.M. fabric must be approved by Global. Fabrics must be 60” wide.
- It is recommended that panels NOT be upholstered with seating fabrics.
- Available in the following panel fabrics:
 - **Grade 1** Agate II
 - **Grade 2** Lola
 - **Grade 3** Brinx and Mariposa
 - **Grade 4** Accent
 - Momentum **Grade 5** Meander, Tracery and Universe (*extended lead time*)

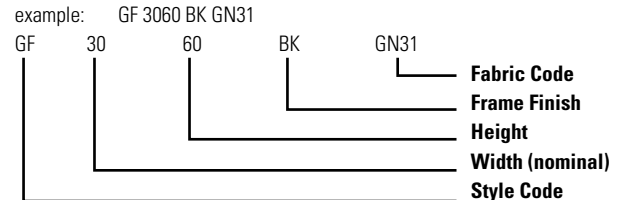
HOW TO ORDER PANELS

PLEASE NOTE: AOOOS overstorage units are designed to be used of the same width and size on both sides of the GPS II panel to ensure equal distribution of weight on the panel. Overstorage units can be used on one side of a panel on short runs, or on cubicles under the following conditions:

- use return panels to stabilize configuration
 - use floor mounts to anchor panel
 - use worksurface connectors to attach panel to worksurface
- See diagrams below for acceptable & unacceptable usage of overstorage units with GPS II panels.
 - GPS II panels are 1” thick and may show some movement after overstorage units are loaded.

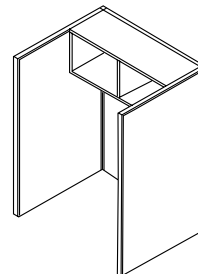

Acceptable Installation

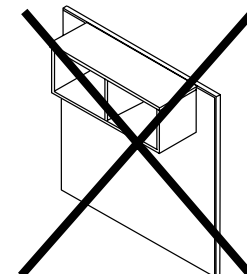

Incorrect Installation

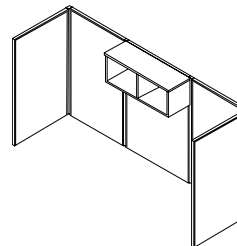

Acceptable Installation

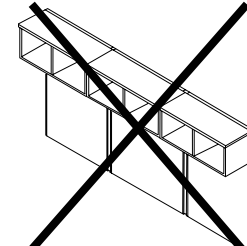

Incorrect Installation

FREESTANDING FABRIC PANELS

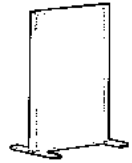

Fabric Panel with Feet - 72" High

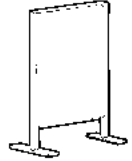

Fabric Panel with Feet - 72" High

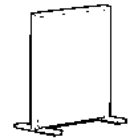

Fabric Panel with Feet - 60" High

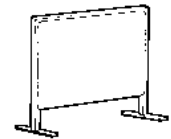

Fabric Panel with Feet - 60" High

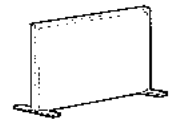

Fabric Panel with Feet - 48" High

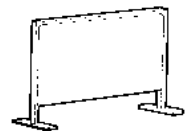

Fabric Panel with Feet - 60" High

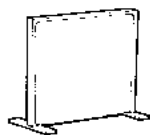

Fabric Panel with Feet - 60" High

MODEL#	DIMENSIONS D x W x H	FREIGHT CLASS	WT/LBS.	CUBIC FT.	GR.1	GR.2	GR.3	GR.4	GR.5	
GPS1	1.75 x 48.37 x 72	92.5	54	5	\$695	\$764	\$880	\$966	\$1062	
Screen to floor panel. Chrome frame and feet only. 2 per carton. <ul style="list-style-type: none"> • Chrome (CH) frame ONLY. • It is recommended that panels NOT be upholstered in seating fabrics. 										
GPS2	1.75 x 48.37 x 72	100	48	5	\$669	\$736	\$848	\$933	\$1026	
Screen is 12" off floor. Chrome frame and feet only. 2 per carton. <ul style="list-style-type: none"> • Chrome (CH) frame ONLY. • It is recommended that panels NOT be upholstered in seating fabrics. 										
GPS3	1.75 x 48.37 x 60	92.5	45	4	\$650	\$717	\$823	\$905	\$995	
Screen to floor panel. Chrome frame and feet only. 2 per carton. <ul style="list-style-type: none"> • Chrome (CH) frame ONLY. • It is recommended that panels NOT be upholstered in seating fabrics. 										
GPS4	1.75 x 60.37 x 60	100	48	5	\$669	\$736	\$848	\$933	\$1026	
Screen is 12" off floor. Chrome frame and feet only. 2 per carton. <ul style="list-style-type: none"> • Chrome (CH) frame ONLY. • It is recommended that panels NOT be upholstered in seating fabrics. 										
GPS5	1.75 x 60.37 x 48	92.5	45	4	\$650	\$717	\$823	\$905	\$995	
Screen to floor panel. Chrome frame and feet only. 2 per carton. <ul style="list-style-type: none"> • Chrome (CH) frame ONLY. • It is recommended that panels NOT be upholstered in seating fabrics. 										
GPS6	1.75 x 72.37 x 60	92.5	50	5	\$766	\$844	\$971	\$1068	\$1174	
Screen is 12" off floor. Chrome frame and feet only. 2 per carton. <ul style="list-style-type: none"> • Chrome (CH) frame ONLY. • It is recommended that panels NOT be upholstered in seating fabrics. 										
GPS7	1.75 x 60.37 x 60	100	46	5	\$730	\$803	\$920	\$1014	\$1115	
Screen to floor panel. Chrome frame and feet only. 2 per carton. <ul style="list-style-type: none"> • Chrome (CH) frame ONLY. • It is recommended that panels NOT be upholstered in seating fabrics. 										

Required Specifications
Fabric

FABRIC PANELS

MODEL# DIMENSIONS FREIGHT CLASS WT/LBS. CUBIC FT. GR. 1 GR. 2 GR. 3 GR. 4 GR. 5

D x W x H

GF2442	1.75 x 24.37 x 42	100	18	2	\$261	\$288	\$330	\$362	\$398
GF3042	1.75 x 30.37 x 42	92.5	21	2	\$269	\$296	\$339	\$371	\$408
GF3642	1.75 x 36.37 x 42	100	24	2.50	\$280	\$308	\$355	\$388	\$426
GF4242	1.75 x 42.37 x 42	125	27	4	\$281	\$311	\$356	\$389	\$427
GF4842	1.75 x 48.37 x 42	125	30	4	\$286	\$315	\$361	\$399	\$438
GF6042	1.75 x 60.37 x 42	100	35	4	\$318	\$352	\$404	\$444	\$488
GF6642	1.75 x 66.38 x 42	100	32	4	\$374	\$410	\$430	\$500	\$550
GF7242	1.75 x 72.37 x 42	100	40	5	\$374	\$411	\$472	\$518	\$569



Fabric Panel - 42" High

1" square tube steel frame. Tackable surface constructed of rigid honeycomb fiber core and covered with fabric. Includes 2 adjustable leveling glides.

- It is recommended that panels NOT be upholstered in seating fabrics.

GF2454	1.75 x 24.37 x 54	100	22	2.50	\$290	\$318	\$366	\$404	\$444
GF3054	1.75 x 30.37 x 54	92.5	25	2.50	\$299	\$330	\$379	\$415	\$456
GF3654	1.75 x 36.37 x 54	100	28	3	\$311	\$341	\$390	\$431	\$474
GF4254	1.75 x 42.37 x 54	125	31	4	\$339	\$374	\$429	\$471	\$518
GF4854	1.75 x 48.37 x 54	100	34	4	\$356	\$389	\$448	\$494	\$543
GF6054	1.75 x 60.37 x 54	92.5	41	4	\$376	\$412	\$473	\$521	\$573
GF6654	1.75 x 66.38 x 54	100	52	6	\$424	\$467	\$495	\$587	\$645
GF7254	1.75 x 72.37 x 54	100	47	5	\$424	\$467	\$537	\$589	\$647

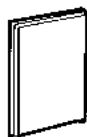

Fabric Panel - 54" High

1" square tube steel frame. Tackable surface constructed of rigid honeycomb fiber core and covered with fabric. Includes 2 adjustable leveling glides.

- It is recommended that panels NOT be upholstered in seating fabrics.

GF2460	1.75 x 24.37 x 60	100	24	2.50	\$296	\$323	\$374	\$447	\$491
GF3060	1.75 x 30.37 x 60	92.5	27	2.50	\$299	\$330	\$379	\$415	\$456
GF3660	1.75 x 36.37 x 60	92.5	30	3	\$317	\$350	\$403	\$443	\$487
GF4260	1.75 x 42.37 x 60	100	33	4	\$335	\$368	\$424	\$507	\$557
GF4860	1.75 x 48.37 x 60	100	36	4	\$336	\$369	\$425	\$510	\$561
GF6060	1.75 x 60.37 x 60	100	44	5	\$358	\$394	\$454	\$543	\$597
GF6660	1.75 x 66.38 x 60	125	42	5.70	\$424	\$467	\$495	\$587	\$645
GF7260	1.75 x 72.37 x 60	100	52	6	\$415	\$459	\$526	\$633	\$696



Fabric Panel - 60" High

1" square tube steel frame. Tackable surface constructed of rigid honeycomb fiber core and covered with fabric. Includes 2 adjustable leveling glides.

- It is recommended that panels NOT be upholstered in seating fabrics.

GF2466	1.75 x 24.37 x 66	125	26	3.50	\$318	\$352	\$404	\$444	\$488
GF3066	1.75 x 30.37 x 66	100	30	3.50	\$323	\$357	\$409	\$450	\$495
GF3666	1.75 x 36.37 x 66	100	34	3.50	\$355	\$388	\$447	\$493	\$542
GF4266	1.75 x 42.37 x 66	125	38	5	\$366	\$404	\$466	\$512	\$563
GF4866	1.75 x 48.37 x 66	100	42	5	\$376	\$412	\$473	\$521	\$573
GF6066	1.75 x 60.37 x 66	100	50	6	\$405	\$445	\$512	\$613	\$674

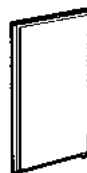

Fabric Panel - 66" High

1" square tube steel frame. Tackable surface constructed of rigid honeycomb fiber core and covered with fabric. Includes 2 adjustable leveling glides.

- It is recommended that panels NOT be upholstered in seating fabrics.

GF2472	1.75 x 24.37 x 72	100	28	3.50	\$321	\$356	\$408	\$447	\$491
GF3072	1.75 x 30.37 x 72	100	32	3.50	\$334	\$367	\$423	\$466	\$512
GF3672	1.75 x 36.37 x 72	92.5	36	3.50	\$359	\$396	\$454	\$498	\$547
GF4272	1.75 x 42.37 x 72	100	40	5	\$379	\$415	\$479	\$525	\$577
GF4872	1.75 x 48.37 x 72	100	44	5	\$382	\$420	\$482	\$529	\$581
GF6072	1.75 x 60.37 x 72	100	52	6	\$429	\$472	\$542	\$596	\$655



Fabric Panel - 72" High

1" square tube steel frame. Tackable surface constructed of rigid honeycomb fiber core and covered with fabric. Includes 2 adjustable leveling glides.

- It is recommended that panels NOT be upholstered in seating fabrics.

Required Specifications

Fabric

FULLY GLAZED PANELS



Fully Glazed Panel - 54" High

MODEL#	DIMENSIONS D x W x H	FREIGHT CLASS	WT/LBS.	CUBIC FT.	GR.1	GR.2	GR.3	GR.4	GR.5
GS2454	1.75 x 24 x 54	85	30	2.50	\$472	\$520	\$597	\$656	\$721
GS3054	1.75 x 30 x 54	85	34	2.50	\$605	\$665	\$763	\$841	\$925
GS3654	1.75 x 36 x 54	85	38	3	\$646	\$710	\$818	\$898	\$987
GS4254	1.75 x 42 x 54	92.5	42	4	\$736	\$810	\$933	\$1026	\$1128
GS4854	1.75 x 48 x 54	92.5	46	4	\$791	\$870	\$1001	\$1101	\$1211
GS6054	1.75 x 60 x 54	85	54	4	\$908	\$998	\$1148	\$1262	\$1388

1" square tube steel frame. Surface around plexiglass is constructed of rigid honeycomb fiber core and covered with fabric. Includes 2 adjustable leveling glides.

- Glazing is available in Clear (**GC**) and Smoked (**GS**) as standard. Frosted (**FZ**) is available at a **10% upcharge**.
- 2 per carton
- It is recommended that panels NOT be upholstered in seating fabrics.



Fully Glazed Panel - 60" High

GS2460	1.75 x 24.37 x 60	125	33	5	\$522	\$575	\$661	\$727	\$799
GS3060	1.75 x 30.37 x 60	125	37	5	\$661	\$727	\$836	\$918	\$1009
GS3660	1.75 x 36.37 x 60	125	41	6	\$709	\$780	\$897	\$986	\$1084
GS4260	1.75 x 42.37 x 60	150	45	8	\$807	\$890	\$1023	\$1125	\$1237
GS4860	1.75 x 48.37 x 60	125	49	8	\$868	\$956	\$1097	\$1206	\$1326
GS6060	1.75 x 60.37 x 60	150	57	10	\$998	\$1098	\$1263	\$1389	\$1527

1" square tube steel frame. Surface around plexiglass is constructed of rigid honeycomb fiber core and covered with fabric. Includes 2 adjustable leveling glides.

- Glazing is available in Clear (**GC**) and Smoked (**GS**) as standard. Frosted (**FZ**) is available at a **10% upcharge**.
- ** Frosted (**FZ**) glazing option is not available on **GS6060***
- 2 per carton
- It is recommended that panels NOT be upholstered in seating fabrics.



Fully Glazed Panel - 66" High

GS2466	1.75 x 24.37 x 66	150	36	7	\$567	\$623	\$718	\$788	\$866
GS3066	1.75 x 30.37 x 66	150	40	7	\$696	\$765	\$881	\$968	\$1064
GS3666	1.75 x 36.37 x 66	125	44	7	\$793	\$871	\$1002	\$1102	\$1212
GS4266	1.75 x 42.37 x 66	150	48	10	\$897	\$987	\$1135	\$1249	\$1373
GS4866	1.75 x 48.37 x 66	150	52	10	\$956	\$1051	\$1207	\$1329	\$1461
GS6066	1.75 x 60.37 x 66	150	60	12	\$1157	\$1275	\$1465	\$1611	\$1772

1" square tube steel frame. Surface around plexiglass is constructed of rigid honeycomb fiber core and covered with fabric. Includes 2 adjustable leveling glides.

- Glazing is available in Clear (**GC**) and Smoked (**GS**) as standard. Frosted (**FZ**) is available at a **10% upcharge**.
- ** Frosted (**FZ**) glazing option is not available on **GS6066***
- 2 per carton
- It is recommended that panels NOT be upholstered in seating fabrics.



Fully Glazed Panel - 72" High

GS2472	1.75 x 24.37 x 72	150	39	7	\$613	\$676	\$776	\$853	\$938
GS3072	1.75 x 30.37 x 72	125	43	7	\$747	\$822	\$943	\$1038	\$1141
GS3672	1.75 x 36.37 x 72	125	47	7	\$826	\$909	\$1044	\$1149	\$1263
GS4272	1.75 x 42.37 x 72	150	51	10	\$984	\$1082	\$1245	\$1368	\$1504
GS4872	1.75 x 48.37 x 72	150	55	10	\$1117	\$1228	\$1414	\$1553	\$1708
GS6072	1.75 x 60.37 x 72	150	63	12	\$1254	\$1379	\$1587	\$1745	\$1919

1" square tube steel frame. Surface around plexiglass is constructed of rigid honeycomb fiber core and covered with fabric. Includes 2 adjustable leveling glides.

- Glazing is available in Clear (**GC**) and Smoked (**GS**) as standard. Frosted (**FZ**) is available at a **10% upcharge**.
- ** Frosted (**FZ**) glazing option is not available on **GS6072***
- 2 per carton
- It is recommended that panels NOT be upholstered in seating fabrics.

Required Specifications

- Fabric
- Glazing

GPS II TRANSACTION TOP & OVERSTORAGE UNITS NOTES

D x W x H

- Hardware must be ordered separately.
- For half sizes, add ½" to model number.
- **ATT96** is the largest size available.
- For Radius cut on both ends, **Add DD** to model number (ex. TT96DD). **15% upcharge.**

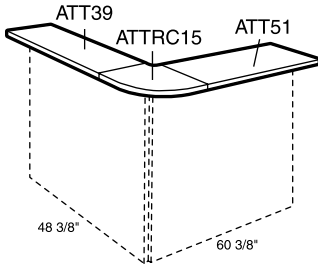

To calculate Transaction Top **CUBIC FOOTAGE**:
 Use the following formula:
 $(w \times d \times h) / 1728 = \text{Cu. Ft.}$
 ex. If transaction top required is 21" long,
 $(21 \times 12 \times 1) / 1728 = .1458$
 Round up to the nearest cube, in this case, 1 cubic foot.

To calculate Transaction Top **SHIPPING WEIGHT**:
 Use the following formula:
 $\text{width required} \times 12 \times 1 \times .025 = \text{Wt. (lbs)}$
 ex. If transaction top required is 20" long,
 $20 \times 12 \times 1 \times .025 = 7.5 \text{ lbs.}$

GPS II TRANSACTION TOP & OVERSTORAGE UNITS NOTES:

- Transaction tops are 1" thick, constructed of 45 lb. density particle board covered top and bottom with thermally fused high performance laminate. Edges are sealed with Global's preferred matching edge.
- Hardware must be ordered separately. Please refer to page xxx for further details.
- Transaction tops are available in the following finishes:

Top and Edge Finishes

ACJ	Absolute Acajou	SKC	Shaker Cherry
ASN	Asian Night	SOG	Storm Grey
AWC	Avant Cherry	TFW	Tiger Fruitwood
AWH	Avant Honey	TMA	Tiger Mahogany
BLK	Black	TMP	Tiger Maple
BRC	Brushed Cobalt	TWL	Tiger Walnut
CSJ	Constellation Java	WHT	White
DES	Dark Espresso	WHC	White Chocolate*
GRY	Grey	WGY	Willow Grey
HGT	Hayden Grey	WCR	Winter Cherry
QTM	Quartered Mahogany		

*textured

TRANSACTION TOPS	MODEL#	DIMENSIONS	FREIGHT CLASS	WT/LB.	CUBIC FT.	LIST PRICE
------------------	--------	------------	---------------	--------	-----------	------------



Straight Transaction Top

ATT14-ATT20	--	150	--	--	\$188
ATT21-ATT25	--	125	--	--	\$216
ATT26-ATT30	--	125	--	--	\$230
ATT31-ATT36	--	100	--	--	\$241
ATT37-ATT48	--	85	--	--	\$247
ATT49-ATT60	--	70	--	--	\$291
ATT61-ATT72	--	70	--	--	\$324
ATT73-ATT85	--	70	--	--	\$357
ATT86-ATT96	--	65	--	--	\$387

12" deep x 1" thick top available in any width. Pricing is based on range. If a change of direction (corner) is required, the cornerpiece must be accounted for. Deduct 8" from each side adjoining a corner piece.

Required Specifications

Finish

TRANSACTION TOPS



Transaction Top with Radius Cut

MODEL#	DIMENSIONS	FREIGHT CLASS	WT/LBS.	CUBIC FT.	LIST PRICE
	D x W x H				
ATT14D-ATT20D	--	150	--	--	\$207
ATT21D-ATT25D	--	125	--	--	\$236
ATT26D-ATT30D	--	125	--	--	\$251
ATT31D-ATT36D	--	100	--	--	\$265
ATT37D-ATT48D	--	85	--	--	\$270
ATT49D-ATT60D	--	70	--	--	\$320
ATT61D-ATT72D	--	70	--	--	\$356
ATT73D-ATT85D	--	65	--	--	\$356
ATT86D-ATT96D	--	65	--	--	\$425

12" deep x 1" thick top with radius cut on one end. Pricing is based on range. If a change of direction (corner) is required, the cornerpiece must be accounted for. Deduct 8" from each side adjoining a corner piece.

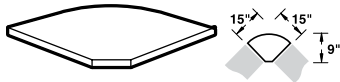

Radius Transaction Top

ATTRC15	15 x 15-72 x 1	85	6	.50	\$260
---------	----------------	----	---	-----	--------------

Corner piece used to change direction. Deduct 8" from the width of each adjoining transaction top. Connecting hardware NOT included.

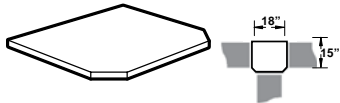

Three-Way Transaction Top

ATT3W	15 x 18-72 x 1	70	9	.60	\$265
-------	----------------	----	---	-----	--------------

Corner piece used to connect three transaction tops, two at 180°, the other at 90°. Deduct 8" from the width of each adjoining transaction top. Connecting hardware NOT included.

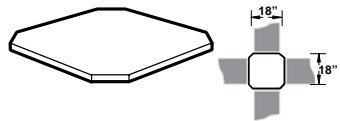

Four-Way Transaction Top

ATT4W	18 x 18-72 x 1	70	10	.50	\$275
-------	----------------	----	----	-----	--------------

Corner piece used to connect four transaction tops at 90°. Deduct 8" from the width of each adjoining transaction top. Connecting hardware NOT included.

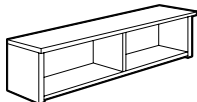

Wall/Panel Mount Overstorage Unit

A00S60	15 x 60 x 16	70	86	5.25	\$603
A00S48	15 x 48 x 16	70	70	4.30	\$493
A00S42	15 x 42 x 16	70	62	3.80	\$486
A00S36	15 x 36 x 16	70	56	3.30	\$429
A00S30	15 x 30 x 16	70	48	3	\$401

Standard with pre-mounted "J" bracket for wall mount applications. Can be hung on GPS II panels with optional **ABR1** hanging bracket. One fixed shelf, closed back. Uses standard Adaptabilities Hutch Doors. Shipped RTA (ready to assemble).

• **NOTE:** Care should be taken to mount the units. Units should be mounted to wall studs using correct fasteners. Failure to do so may result in collapse of the unit and subsequent personal injury. **Mounting hardware not included.** Mounting hardware used should be based on wall material. Consult an installation professional for proper wall mounting.

Required Specifications

Finish
Edge Detail

OVERSTORAGE UNITS

MODEL# DIMENSIONS FREIGHT CLASS WT/LBS. CUBIC FT. LIST PRICE

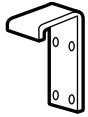

Hanging Bracket

	D x W x H				
ABR1	--	70	1	.01	\$70

Used to hang overstorage unit on GPS II Panels. Accommodates maximum 1 1/2" thick panels. Set includes two hanging brackets, spacing plates and screws

- Additional hardware and panels may be needed for stability. Floor mounts are required for panel installation.

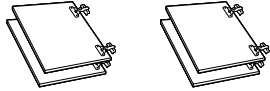

Four-Door Kit

AD00R60	.69 x 14.75 x 15	85	22	1.80	\$317
---------	------------------	----	----	------	--------------

For use on 72", 71", 66" and 60"W straight hutches. Hinges included. Locks available, ADD **\$95** each lock. Doors for units 60" wide or more require two locks.

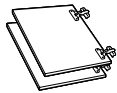

Two-Door Kit

AD00R48	.69 x 23.5 x 15	92.5	18	1.80	\$205
AD00R42	.69 x 20.5 x 15	100	17	1.80	\$205
AD00R36	.69 x 17.5 x 15	100	15	1.80	\$205
AD00R30	.69 x 14.5 x 15	125	13	1.80	\$205

For use on 48", 42" 36" and 30"W straight hutches. Hinges included. Locks available, ADD **\$95** each lock. Doors for units 48" wide or less require one lock.



Top Cap

Finishes top of square post.

PB1 \$13

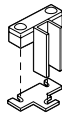

"T" Bracket Connector - 2-low / 1-high

Connects 3 panels where 2 are equal height, 1 is higher

PB5 \$29

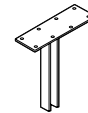

Reception / Transaction Top Bracket - Single

To be used at end of panel.

SB \$38



180° Connector

Connects two panels of equal height at 180°.

PB2 \$25

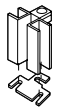

"T" Bracket Connector - 2-high / 1-low

Connects 3 panels where 2 are equal height, 1 is lower.

PB6 \$29

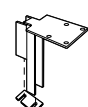

Reception / Transaction Top Bracket











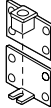
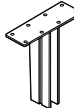

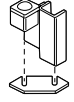

Connects two panels of variable height at 180°.

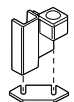
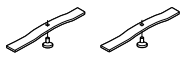
SB2 \$48

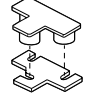
Required Specifications

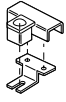
Finish
Edge Detail (A00S__ units only)

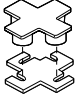
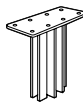
GPS II HARDWARE

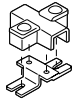
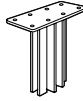
 <p>180° Connector Connects two panels of variable height at 180°.</p>	<p>PB2V \$25</p>	 <p>D x W x H</p> <p>Wall-Mounting Connector Connects panel to a wall.</p>	<p>PBW \$29</p>	 <p>Reception / Transaction Top Bracket - Double Connects two panels of equal height at 180°.</p>	<p>DB \$38</p>
 <p>90° Connector Connects two panels of equal height at 90°.</p>	<p>PB2L \$25</p>	 <p>Wall Channel Connector - 36" long Specify Black (BLK), Business Grey (BGR), Nevada (NEV).</p>	<p>PBWC \$48</p>	 <p>Reception / Transaction Top Bracket - Corner Connects two panels of equal height at 90°.</p>	<p>CB \$38</p>
 <p>90° Connector - Left Connects two panels of variable height at 90°.</p>	<p>PB2LV \$25</p>	 <p>Panel-to-Worksurface Bracket Connector Can be used as left or right.</p>	<p>PDT \$34</p>	 <p>Recept / Trans Top Wall-Mounting Connector Connects transaction tops to walls.</p>	<p>SBW \$48</p>
 <p>90° Connector - Right Connects two panels of variable height at 90°.</p>	<p>PB2RV \$25</p>	 <p>Self-Supporting Feet (1 pair) Specify Black (BK), Business Grey (BG), Nevada (NV), Chrome (CH). 1.5" x 19".</p>	<p>SF \$94</p>	 <p>Transaction Top Bracket - Variable Height (left) For 90° panel. Connects transaction top to left side of corner. Add 1" extra to top to cover bracket.</p>	<p>SB2LV \$50</p>
 <p>T Connector Connects three panels of equal height at 3-way intersection.</p>	<p>PB3 \$25</p>	 <p>Floor Mount Available in Chrome only.</p>	<p>FM \$38</p>	 <p>Transaction Top Bracket - Variable Height (right) For 90° panel. Connects transaction top to right side of corner. Add 1" extra to top to cover bracket.</p>	<p>SB2RV \$50</p>
 <p>T Connector - Mid-Panel Connects one panel to another at its midpoint.</p>	<p>PB3H \$25</p>	 <p>4-Way Transaction Top Mid-Panel Connector Connects top perpendicular to back panels.</p>	<p>SB4H \$91</p>	 <p>Coat Hanger Available in Chrome (CHM).</p>	<p>CH \$25</p>
 <p>4-Way Connector Connects four panels at a common intersection.</p>	<p>PB4 \$25</p>	 <p>3-Way Transaction Top Connector Connects three transaction tops, two at 180°, 1 at 90°.</p>	<p>3WB \$50</p>	 <p>3-Way Transaction Top Mid-Panel Connector Connects transaction top perpendicular to back panels.</p>	<p>SB3H \$55</p>
 <p>4-Way Connector - Mid-Panel Connects three panels, two at midpoint of the third.</p>	<p>PB4H \$29</p>	 <p>4-Way Transaction Top Connector Connects four transaction tops, each at 90°.</p>	<p>4WB \$52</p>		

NOTE: ALL HARDWARE IS FINISHED IN BLACK, EXCEPT WHERE NOTED.

productivity solutions



Productivity Solutions

496



Productivity Solutions™ by Global is a comprehensive series of ergonomically sound products, naturally connecting people with technology to enhance comfort and productivity. Designed to Fit you and your technology and fully integrate with Global Furniture Group products to create complete office solutions that meet the needs of today's diverse workplaces.

Designed with human capabilities and comfort in mind, Productivity Solutions by Global provide a good Fit for today's workers and meet or exceed ergonomics standards, guidelines and ANSI/BIFMA standards for performance, durability and safety.

FIT = Move + Match + Support



Features and Benefits

- Foli Height Adjustable Table with 18.4" height range
- Manual Height Adjustable Table has counterbalanced spring mechanism
- 4 keyboard support mechanisms
- 5 keyboard trays
- New monitor arm options
- Wire management and power/data options
- Meets ANSI-BIFMA, Greenguard Indoor Air Quality, Greenguard Gold Certified
- Height Adjustable Tables are BIFMA level 2 certified



Monitor Arms



Power/Data Module



Lift n Lock Keyboard Tray



Foli Electric Height Adjustable Table



Manual Height Adjustable Desk



Obusforme Keyboard Tray

MANUAL HEIGHT ADJUSTABLE TABLES

- Manually operated height adjustable tables with counterbalanced spring mechanism
 - Exceptional ergonomic alternative to traditional desking
 - Sit-Stand design promotes increased circulation, improving performance and comfort
 - Can be used alone or in conjunction with Global desks.
- Please note:** Global desks are 1" or 1.5" thick.
- Meets ANSI/BIFMA requirements

TOP FINISHES

ACJ Absolute Acajou	ASN Asian Night
AWC Avant Cherry	AWH Avant Honey
BLK Black	BRC Brushed Cobalt
CSJ Constellation Java	DES Dark Espresso
GRY Grey	HGT Hayden Grey
QTM Quartered Mahogany	SKC Shaker Cherry
SOG Storm Grey	TFW Tiger Fruitwood
TMA Tiger Mahogany	TMP Tiger Maple
TWL Tiger Walnut	WHT White
WHC White Chocolate*	WGY Willow Grey
WCR Winter Cherry	

* textured, HP non-textured, top only

CONSTRUCTION

- 1" thick tops constructed of 45 lb. density particle board with high performance thermally fused laminate

DIMENSIONS

- When designing workstations, leave 1" clearance on either side to prevent finger pinch

EDGE

- Preferred matching edge

BASE

- Heavy duty steel formed legs with radius detail are available in BLACK only
- Easy to reach tension control supports loads up to 100 lbs.
- Environmentally friendly, recyclable epoxy powder coating provides a very durable finish
- Black plastic leveling glides offer 1/2" adjustability

GROMMETS

- Grommets available in standard worksurface locations (left, center or right)
- Order as: **AG1, AG2 or AG3.....ADD \$65**

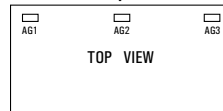

- Grommet hole dimensions are 3 1/4" wide x 1 7/8" deep

MECHANISM

- Counterbalanced height adjustable base supports weights up to 100 lbs.
- Height range from floor to underside of modesty shroud is 17" when surface height is 26"
- 7 year warranty

SHIPPING

- Shipped RTA (Ready to Assemble)
- Easy to assemble with Phillips or Robertson screwdriver

MODEL#	DIMENSIONS D x W x H	FREIGHT CLASS	WT./LBS.	CUBIC FT.	LIST PRICE
Rectangular Tops:					
HTM3058T	30 x 58 x 1	70	50	2.50	\$369
HTM3046T	30 x 46 x 1	70	40	2	\$308
HTM2458T	24 x 58 x 1	70	40	2	\$283
HTM2446T	24 x 46 x 1	70	32	1.50	\$262
Base:					
KEZLIFT	24 x 34.5 x 26-46	70	88	5.40	\$1994

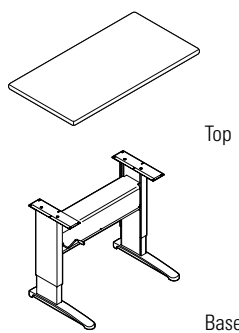

Rectangular Table

Paddle activated height adjustable base. Height adjustable from 26" to 46". Keyboard tray and mechanism not necessary

- **Specify base separately from top**

Required Specifications
Top Finish

FOLI ELECTRIC HEIGHT ADJUSTABLE TABLES

D x W x H

- Electric height adjustment allows for easy movement from sitting to standing and back throughout the day. Foli's work surface moves with you and your work without interruption.
- Foli offers a universal free-standing design and finish options to easily integrate with existing Global workstation configurations, becoming a natural part of your office space
- Whether in a private or general office, touch-down space, collaborative area or home office, Foli supports a more active and healthy work style
- Can be used alone or in conjunction with Global desks. Please note Global desks are 1" or 1.5" thick.

TOP FINISHES

ACJ	Absolute Acajou	ASN	Asian Night
AWC	Avant Cherry	AWH	Avant Honey
BLK	Black	BRC	Brushed Cobalt
CSJ	Constellation Java	DES	Dark Espresso
HGT	Hayden Grey	QTM	Quartered Mahogany
SKC	Shaker Cherry	SOG	Storm Grey
TFW	Tiger Fruitwood	TMA	Tiger Mahogany
TMP	Tiger Maple	TWL	Tiger Walnut
WHT	White	WHC	White Chocolate*
WGY	Willow Grey	WCR	Winter Cherry

* textured, HP non-textured, top only

EDGE

- Preferred matching edge

CONSTRUCTION

- 1" thick tops constructed of 45 lb. density particle board with high performance thermally fused laminate
- Steel constructed leg tubing, feet and cross bar
- Table frame designed with 3.15" x 2.35" rectangular outer leg with large tubing facing down
- "T" leg, flat foot design with adjustable glides
- Expandable cross bars for table widths of 48", 54", 60", 66" and 72"
- Available table depths of 24" and 30"

BASE

- Electric switch provides height adjustment from 27.8" to 46.2"
- Leveling glides offer 1" adjustability
- Simple up/down electronic finger control, operates at 1" per second
- Lifts 220 lbs.
- Single motor hex rod drive system
- Shadow power draw 0.5 watts
- Base available in a Silver powder coated finish, will never mar during adjustment

SHIPPING

- Shipped unassembled in 1 carton
- Easy to assemble.

GROMMETS

- Grommets available in standard table top locations (left, center or right). Order as: **AG1, AG2 or AG3 - Add \$65**
- Grommet hole dimensions are 3 1/4" wide x 1 7/8" deep.
- Grommets may be placed at non-standard locations. Order as: **AGS - Add \$65**. A drawing must be supplied with vertical and horizontal dimensions to the center of the cut-out (as in drawing below). Please refer to CUSTOM GROMMET LOCATION FORM in the back reference section.

Grommet hole dimensions:

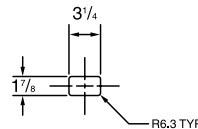

Grommet:

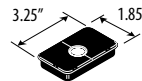

Grommet Locations:

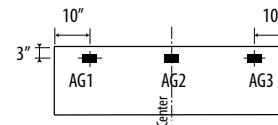

FOLI ELECTRIC HEIGHT ADJUSTABLE TABLES

MODEL# DIMENSIONS FREIGHT CLASS WT/LBS. CUBIC FT. LIST PRICE HP ADD

D x W x H

Rectangular Tops:

PHAT3072T	29 x 70 x 1	65	70	2.50	\$392	\$196
PHAT3066T	29 x 64 x 1	65	64	2.26	\$373	\$187
PHAT3060T	29 x 58 x 1	65	59	2.10	\$357	\$179
PHAT3054T	29 x 52 x 1	65	52	1.90	\$350	\$175
PHAT3048T	29 x 46 x 1	65	44	1.70	\$342	\$171
PHAT2472T	23 x 70 x 1	65	57	2	\$388	\$194
PHAT2466T	23 x 64 x 1	65	52	1.82	\$359	\$180
PHAT2460T	23 x 58 x 1	65	47	1.67	\$343	\$172
PHAT2454T	23 x 52 x 1	65	42	1.52	\$307	\$154
PHAT2448T	23 x 46 x 1	65	35	1.40	\$286	\$143

Base:

PHATES470	10 x -- x 26.8	60	65	1.40	\$1264	n/a
-----------	----------------	----	----	------	---------------	-----

All table frames are easy to assemble with few parts. Simple up/down hand switch. Lifts 220 lbs. Base manufactured so that leg paint will never mar during height adjustment. Leg assembly tubing, feet and upper structure assemblies constructed of steel. Table frame designed with 3.15" x 2.36" rectangular outer leg with the large tube facing down. Flat foot design with adjustable glides. I-profile crossbars that are expandable in fixed steps to create a variety of size table widths. Height range is 27.8" to 46.2" (18.4" adjustability). Single motor hex rod drive system. Operates at 1" per second. Shadow power draw is 0.5 watts. Maximum power draw is 1.5A. Base finish in Silver powder coat only.

- Specify base separately from top

P79100014	- x - x 1.5	60	2	0.4	\$56	N/A
-----------	-------------	----	---	-----	-------------	-----

Pack of four casters, two locking and two non-locking. Interchangeable on site with levelers on Foli electric height adjustable table PHATES470.



Top

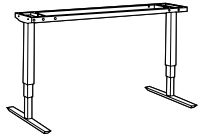

Base

Foli Rectangular Table

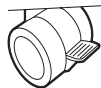

1.5" Dual Wheel Casters

Required Specifications

Top Finish

Optional Specifications

High Pressure Laminate
Grommet

MONITOR ARMS
MODEL#
DIMENSIONS
FREIGHT CLASS
WT./LBS.
CUBIC FT.
LIST PRICE
D x W x H

- Free up valuable space on surfaces
- Attach to any standard surface with flush edge by a desk clamp or through a grommet. Grommets above support panels cannot be used for mounting. Mounting hardware included.
- Clamps on worksurfaces 1/2" to 2 5/8" thick
- 9" vertical height adjustment on 12" post
- For use in grommets up to 3.5" wide
- Built-in cable management
- Quick connect option is standard with hole patterns to meet Video Electronics Standards Association (VESA) standards (75mm x 75mm or 100mm x 100mm)
- Monitor arm components are 100% recycled aluminum die cast material, providing stability and durability
- Available finishes: Silver (**SIL**) standard; Black (**BLK**) and White (**WTE**)

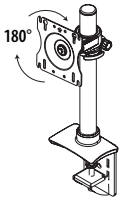
Single Screen Pole Position

MON1SPP	-- x -- x --	150	5.80	1.20	\$238
---------	--------------	-----	------	------	--------------

No extension arms. Minor assembly required. Supports 20 lb. load capacity. No maximum monitor width.

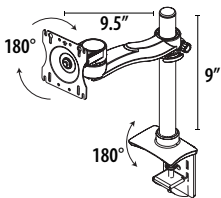
Single Screen Single Extension Arm

MON1SSE	-- x -- x --	150	6.20	1.20	\$321
---------	--------------	-----	------	------	--------------

9.5" horizontal reach from center of pole to front of monitor mounting plate. Displays are able to tilt 180°, swing 180° side-to-side and rotate from landscape to portrait. Minor assembly required. Supports 20 lb. load capacity. No maximum monitor width.

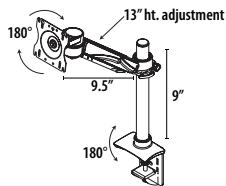
Single Screen Single Extension Arm with Height Adjustment

MON1SSEH	-- x -- x --	125	7.20	1.10	\$412
----------	--------------	-----	------	------	--------------

Counterbalanced arm provides an additional 13" of height adjustment. Easy to use Allen wrench allows user to adjust the counterbalance mechanism for easy movement of the monitor. 9.5" horizontal reach from center of pole to front of monitor mounting plate. Displays are able to tilt 180°, swing 180° side-to-side and rotate from landscape to portrait. Minor assembly required. Supports 20 lb. load capacity. No maximum monitor width.

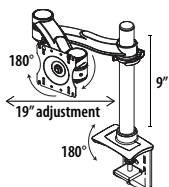
Single Screen Double Extension Arm

MON1SDE	-- x -- x --	125	7.50	1.20	\$402
---------	--------------	-----	------	------	--------------

Double extension allows 19" of horizontal back and forth movement. Arm folds back to post for more desk space. Displays are able to tilt 180°, swing 180° side-to-side and rotate from landscape to portrait. Minor assembly required. Supports 20 lb. load capacity. No maximum monitor width.

Required Specifications

Finish

MONITOR ARMS

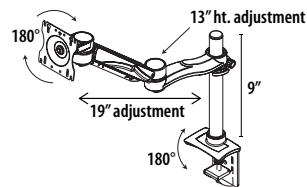

Single Screen Double Extension Arm with Height Adjustment

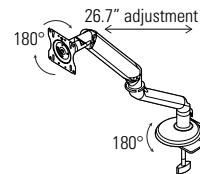

Single Screen Double Extension Arm - Light Duty

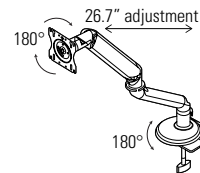

Single Screen Double Extension Arm - Medium Duty

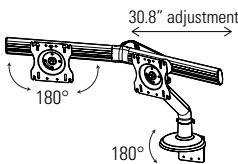

Dual Screen Double Extension Arm - Heavy Duty

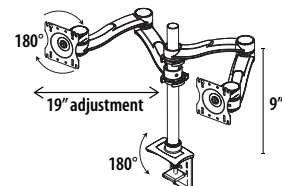

Dual Screen Double Extension Arm

MODEL# DIMENSIONS FREIGHT CLASS WT./LBS. CUBIC FT. LIST PRICE

	D x W x H				
MON1SDEH	-- x -- x --	125	8.20	1.10	\$484

Counterbalanced arm provides an additional 13" of height adjustment. Double extension allows 19" of horizontal back and forth movement. Easy to use Allen wrench allows user to adjust the counterbalance mechanism for easy movement of the monitor. Displays are able to tilt 180°, swing 180° side-to-side and rotate from landscape to portrait. Cable manager comes on extension arm and hides all cables. Minor assembly required. Supports 20 lb. load capacity. No maximum monitor width.

M7750LD	5.5 x -- x --	100	10.34	1.12	\$553
---------	---------------	-----	-------	------	--------------

For use with monitors weighing 5 to 20 lbs. Adjustable counterbalance provides free floating fingertip control. Maximum of 26.7" extension from rear of desk to back of monitor; folds to 4.5". Monitor can rotate 180° for portrait or landscape viewing with -90° to 45° tilt adjustment. Integral monitor weight adjustment gauge. Aluminum die cast construction. VESA plate edge clamp and grommet mount included. Silver finish. Some assembly required. Supports 20 lb. load capacity. No maximum monitor width.

• Also available in **Black finish** #M7750LDB or **White finish** #M7750LDW.

M7755MD	5.5 x -- x --	100	10.34	1.12	\$590
---------	---------------	-----	-------	------	--------------

For use with monitors weighing 10 to 30 lbs. Adjustable counterbalance provides free floating fingertip control. Maximum of 26.7" extension from rear of desk to back of monitor; folds to 4.5". Monitor can rotate 180° for portrait or landscape viewing with -90° to 45° tilt adjustment. Integral monitor weight adjustment gauge. Aluminum die cast construction. VESA plate edge clamp and grommet mount included. Silver finish. Some assembly required. Supports 20 lb. load capacity. No maximum monitor width. • Also available in **Black finish** #M7755MDB or **White finish** #M7755MDW.

M7760HD	26 x -- x --	92.5	14.75	1.3	\$766
---------	--------------	------	-------	-----	--------------

For use with monitors weighing 15 to 40 lbs. and maximum width of 24" diagonal. Adjustable counterbalance provides free floating fingertip control. Maximum of 30.8" extension from rear of desk to back of monitor; folds to 8.4". Monitor can rotate 180° for portrait or landscape viewing with -90° to 45° tilt adjustment. Integral monitor weight adjustment gauge. Aluminum die cast construction. VESA plate edge clamp and grommet mount included. Silver finish. Some assembly required. Supports 20 lb. load capacity. No maximum monitor width.

• Also available in **Black finish** #M7760HDB or **White finish** #M7760HDW.

MON2SDE	-- x -- x --	100	10.70	1.20	\$712
---------	--------------	-----	-------	------	--------------

For dual monitor applications. Double extension arms allow 19" of horizontal back and forth movement. Easy to use Allen wrench allows user to adjust the counterbalance mechanism for easy movement of the monitor. Displays are able to tilt 180°, swing 180° side-to-side and rotate from landscape to portrait. Minor assembly required. Supports 20 lb. load capacity. 32" maximum monitor width.

MONITOR ARMS

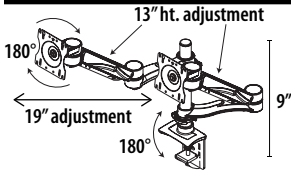

Dual Screen Double Extension Arm with Height Adjustment

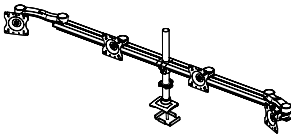

Parabolic Quad Screen Beam Mount

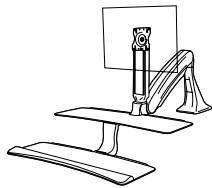

Single Screen Sit-Stand Workstation with Keyboard Tray and Shelf

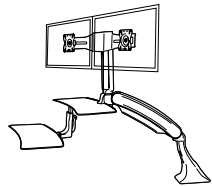

Dual Screen Sit-Stand Workstation with Keyboard Tray and Shelf

MODEL#	DIMENSIONS D x W x H	FREIGHT CLASS	WT./LBS.	CUBIC FT.	LIST PRICE
MON2SDEH	-- x -- x --	150	6	1.20	\$883

For dual monitor applications. Counterbalanced arms provide an additional 13" of height adjustment. Double extension arms allow 19" of horizontal back and forth movement. Easy to use Allen wrench allows user to adjust the counterbalance mechanism for easy movement of the monitor. Displays are able to tilt 180°, swing 180° side-to-side and rotate from landscape to portrait. Cable manager comes on extension arm and hides all cables. Minor assembly required. Supports 20 lb. load capacity. 35" maximum monitor width.

MONQSBM	-- x -- x --	65	18.30	.70	\$1155
---------	--------------	----	-------	-----	---------------

Supports four monitors. Two outside single extension arms tilt 180° and swing 180° side-to-side. All displays can be rotated from landscape to portrait. Beam is 63.9"w. Minor assembly required. Supports 20 lb. load capacity. 21" maximum monitor width. Bracket for grommet mount only included.

M6011WS	28 x -- x --	125	36	4.8	\$2350
---------	--------------	-----	----	-----	---------------

Desktop edge (rear, side or corner) or grommet mount on 24" or 30" deep worksurfaces. Transition between seated and standing positions, HFES compliant. Over 22" of gas assisted height adjustment plus independent height adjustable mechanism for the keyboard tray. Additional 9.5" of independent counterbalance height adjustment for the monitor. 45° of tilt and 90° of portrait to landscape rotation. Monitor weight limit from 5 to 25 lbs. Silver/Grey (SG) finish. Assembly required.

- Also available in **Black/Black (B/B) finish** #M6011WSBB or **White/Grey (WG) finish** #M6011WSWG.

M6021WS	28 x -- x --	100	42	4.8	\$2602
---------	--------------	-----	----	-----	---------------

Desktop edge (rear, side or corner) or grommet mount on 24" or 30" deep worksurfaces. Transition between seated and standing positions, HFES compliant. Over 22" of gas assisted height adjustment plus independent height adjustable mechanism for the keyboard tray. Additional 9.5" of independent counterbalance height adjustment for the monitor. 45° of tilt and 90° of portrait to landscape rotation. Accommodates most 24" monitors weighing up to 8 lbs. each and offers independent screen adjustments. Silver/Grey (SG) finish. Assembly required.

- Also available in **Black/Black (B/B) finish** #M6021WSBB or **White/Grey (WG) finish** #M6021WSWG.

Required Specifications
Finish (MONQSBM only)

KEYBOARD TRAYS



OBUSforme® Tray

MODEL# DIMENSIONS FREIGHT CLASS WT./LBS. CUBIC FT. LIST PRICE

MODEL#	D x W x H	FREIGHT CLASS	WT./LBS.	CUBIC FT.	LIST PRICE
POBUSTRAY	26.5 x 15.75 x 3	70	7.20	.43	\$214

Floating Mouse Tray slides over numeric keys and can be easily positioned to the left or right of keyboard. Height Adjustable Palm Rest can easily be positioned on left or right side of tray to accommodate mouse position, also can be removed by the user. Includes anti-slip strips. ABS construction. Compatible with all Global keyboard mechanisms.

- **Specify mechanism separately (see next page)**

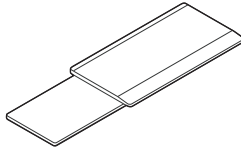

Tray with Sliding Mouse Support

KT01	10.5 x 21.3 x 2	70	7	.40	\$195
------	-----------------	----	---	-----	--------------

Mouse surface slides below support for left or right mouse positioning. Keyboard surface is 21" w x 11" d. Mouse surface extends 9" beyond the side of the tray. Compatible with all Global keyboard mechanisms.

- **Specify mechanism separately (see next page)**

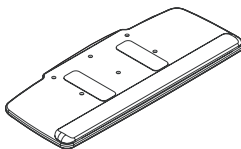

27" HDPE Tray

KT27M02	11.5 x 27.5 x 1	70	6	.40	\$251
---------	-----------------	----	---	-----	--------------

Allows mouse to be easily positioned at the same height as, and to the left or right of, the keyboard. Palm rest is easily removable. Includes Mouse Fence with Cable Manager to secure the mouse when the tray is tilted. Includes anti-slip strips. High Density Polyethylene (HDPE) construction. Compatible with all Global keyboard mechanisms.

- **Specify mechanism separately (see next page)**

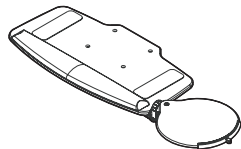

Tray with Height Adjustable Mouse Support - Black

KTMT03	11.5 x 23 x 2.8	100	5.80	.60	\$271
--------	-----------------	-----	------	-----	--------------

Low profile tray with highly adjustable Mouse Support that allows the user to position the mouse surface according to their needs and preferences. Mouse support features include: height adjustment, swivel and tilt. User can easily mount on left or right side of keyboard tray, easily swivel and adjust the height position to maintain neutral postures, and independently adjust the mouse surface tilt so mouse stays on the support when the keyboard tray is tilted. Compatible with all Global keyboard mechanisms. Palm rest is easily removable. Includes Mouse Fence with Cable Manager and anti-slip strips. Keyboard tray is 20.5" w x 11" d and mouse support is 11" in diameter.

- **Specify mechanism separately (see next page)**

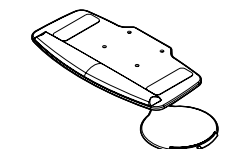

Tray with Swivel Mouse Support - Warm White

KTMT03-W	11.5 x 23 x 2.8	100	5.80	.60	\$367
----------	-----------------	-----	------	-----	--------------

Low profile tray with swivel mouse support. User can easily mount on left or right side of keyboard tray. Compatible with all Global keyboard mechanisms. Palm rest is easily removable. Includes mouse fence with cable manager and anti-slip strips. Keyboard tray is 23" W x 11.5" D and mouse support is 11" in diameter.

- **Specify mechanism separately (see next page)**

KEYBOARD TRAYS / MECHANISMS

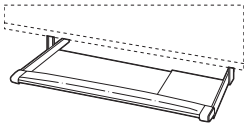

Retractable Keyboard

MODEL#	DIMENSIONS D x W x H	FREIGHT CLASS	WT/LBS.	CUBIC FT.	LIST PRICE
PKBT-27	17.5 x 27 x 4.5	65	10.50	.40	\$237
PKBT-27A	17.5 x 27 x 4.5	125	11	1.45	\$240

PKBT-27 - Retractable Keyboard. PKBT-27A - Retractable Keyboard - Assembled

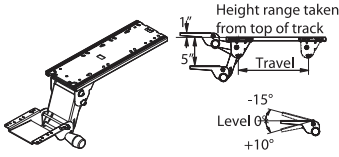

Soft Touch Keyboard Support Mechanism

KSM01-21	23.8 x 9 x 4.3	85	9.20	.70	\$193
KSM01-18	19.7 x 7.4 x 3.6	85	7.60	.60	\$193
KSM01-12	13 x 5 x 2.4	85	5.10	.40	\$193

Soft Touch Knob for simultaneous height and tilt adjustment. Spring-assist mechanism. Optional positive tilt lockout available. Add “-L” to end of model number. Compatible with all Global keyboard mechanisms. Good for single users who do not adjust their keyboard often.

- KSM01-21 requires 21.75” of depth clearance under the surface for installation.
- KSM01-18 requires 18” of depth clearance under the surface for installation.
- KSM01-12 requires 12” of depth clearance under the surface for installation.
- **Specify keyboard tray separately (see previous page)**

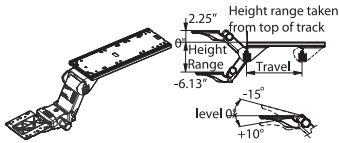

Lift-N-Lock Keyboard Support Mechanism

KSM02-21	23.8 x 9 x 9.7	85	9.70	.70	\$254
KSM02-18	19.7 x 7.4 x 8.2	85	8	.60	\$254
KSM02-12	13 x 5 x 5.4	85	5.40	.40	\$254

Knobless height adjustment and independent tilt adjustment. Locks automatically into position with release of tray. Positive tilt lockout available. Compatible with all Global keyboard mechanisms. Good for single users who frequently change positions and for multiple users.

- KSM02-21 requires 21.75” of depth clearance under the surface for installation.
- KSM02-18 requires 18” of depth clearance under the surface for installation.
- KSM02-12 requires 12” of depth clearance under the surface for installation.
- **Specify keyboard tray separately (see previous page)**

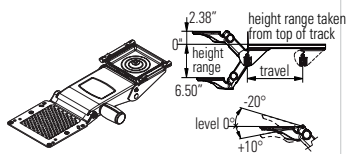

Slim Fit Keyboard Support Mechanism

Black:					
KSFK-21	17.5 x 7.5 x 4.75	70	9	.60	\$254
KSFK-18	17.5 x 7.5 x 4.75	70	8.30	.50	\$254
KSFK-12	17.5 x 7.5 x 4.75	85	7.30	.50	\$254

Warm White:					
KSFK-21-W	17.5 x 7.5 x 4.75	85	9	0.7	\$302

Super slim profile accommodates leg clearance requirements of more users. Knobless height adjustment and independent tilt adjustment. Positive tilt lockout available. Height and depth indicators together in dashboard. Compatible with all Global keyboard mechanisms. Good for single users who frequently change positions and for multiple users. Swivels 360°.

- KSFK-21 requires 21.75” of depth clearance under the surface for installation.
- KSFK-18 requires 18” of depth clearance under the surface for installation.
- KSFK-12 requires 12” of depth clearance under the surface for installation.
- **Specify keyboard tray separately (see previous page)**

KEYBOARD MECHANISMS

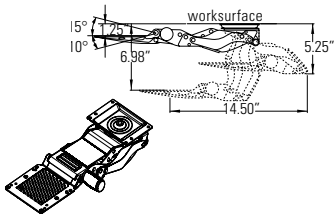

Trackless Keyboard Support Mechanism

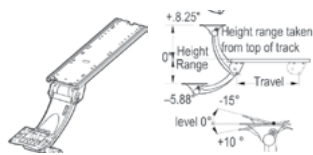

Lift-N-Lock Sit-Stand Mechanism

MODEL# DIMENSIONS FREIGHT CLASS WT./LBS. CUBIC FT. LIST PRICE

D x W x H

Black:					
KSTRKLS-B	14.5 x 7.5 x 5.25	70	6	0.3	\$357

Super slim profile trackless keyboard mechanism designed to fit worksurfaces such as height adjustable tables and benching systems, where space is limited and conventional track mounted keyboard mechanisms will not fit. Knobless height adjustment and independent tilt adjustment. Positive tilt lockout available by special order with extended lead time. Compatible with all Global keyboard trays.

- **Specify keyboard tray separately (see previous page)**

KSM03-21	23.8 x 9 x 9.7	85	11.80	.90	\$409
KSM03-18	19.7 x 7.4 x 8	85	9.70	.70	\$409
KSM03-12	13 x 5 x 5.3	85	6.50	.50	\$409

Ergonomic support for both seated and standing positions. Curved neck allows user closer access to the desk. Positive tilt lockout available. Compatible with all Global keyboard mechanisms. Recommended for single users who alternate between sitting and standing.

- KSM03-21 requires 21.75" of depth clearance under the surface for installation.
- KSM03-18 requires 18" of depth clearance under the surface for installation.
- KSM03-12 requires 12" of depth clearance under the surface for installation.
- **Specify keyboard tray separately (see previous page)**

CPU HOLDERS

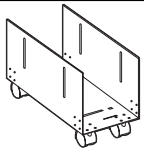

CPU Holder on Casters

PCPU-HC	15 x 5 x 10.37	70	8	.45	\$136
---------	----------------	----	---	-----	--------------

Adjusts 5" - 9" in width. Front locking casters. Assembly hardware included. Height without CPU is 10.4". Depth without CPU is 15". Black only.

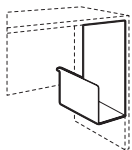

Power Park CPU Holder

PCPU-HO	15 x 5-11 x 18	92.5	11.50	1.06	\$119
---------	----------------	------	-------	------	--------------

Desk mounted CPU Holder. Adjusts 5" - 11" in width. Mounting hardware included. Height without CPU is 18". Depth without CPU is 15". Black only.



CPU Holder on Glide Track

PCPU-GT	-- x -- x --	100	12.60	1.40	\$291
---------	--------------	-----	-------	------	--------------

Accepts tower CPUs with widths from 3.5" to 9.3" and heights from 12.5" to 22.5". 17" glide track and 360° swivel for easy access to rear of CPU. Steel and engineered resin construction.

LAPTOP STANDS

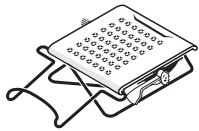

OBUSforme® Laptop Stand

MODEL#	DIMENSIONS D x W x H	FREIGHT CLASS	WT/LBS.	CUBIC FT.	LIST PRICE
POBSMONST	20.5 x 18 x 2.25-5.88	65	11.40	.44	\$258

Supports laptops or monitors. Height adjustable from 2.3" to 5.4". Platform is 14"w x 16.3"d. Removable inline document holder supports letter or legal size documents.



Laptop Stand

PLTS125	13 x 10 x 3.5	70	1.80	.10	\$135
---------	---------------	----	------	-----	--------------

5 angle adjustments. 4 Port USB hub. Plug-and-play installation. No drivers required. Easy to store and pack for travel. Fits into most computer bags. Two tone Black/Grey only.



Laptop Desk

PNT30	15.25 x 26 x 24-29	92.5	17	1.60	\$323
-------	--------------------	------	----	------	--------------

Height adjustable from 24" to 29". Surface is angle adjustable with a palm rest. Can be used for keyboards. Locking casters and leveling glides. Top is 24"w x 13.5"d. Top surface is available in Granite (GPT) only. Black frame only.

DOCUMENT HOLDERS

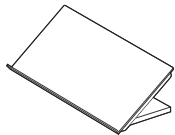

Desktop Document Holder

PDHC200	8 x 16 x 10	85	4.30	.30	\$175
---------	-------------	----	------	-----	--------------

Heavy duty steel document holder. Magnetic line guide. Angle adjustable. Black (BLK) only.



In Line Document Holder

PMAILDH	-- x -- x --	70	.20	.30	\$137
---------	--------------	----	-----	-----	--------------

Supports letter or legal size documents. Use with Monitor Arms. **Available in Black (BLK) or Silver (SIL).**

RESTS

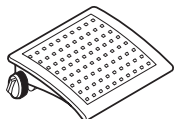

OBUSforme® Footrest

POBUSFOTR	14 x 18 x --	300	7	4.90	\$178
-----------	--------------	-----	---	------	--------------

3 adjustable positions, 5° to 15°. Sturdy support, non-skid surface. Two tone Black/Grey only.

Required Specifications

Finish (PMAILDH only)

LIGHTING

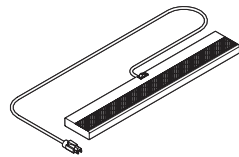

Task Light

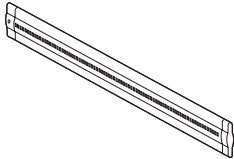

LED Task Light

MODEL# DIMENSIONS FREIGHT CLASS WT/LBS. CUBIC FT. LIST PRICE

D x W x H

PVET5L48	4.25 x 48 x 1.25	65	8	.28	\$175
PVET5L36	4.25 x 36 x 1.25	65	6	.21	\$158
PVET5L24	4.25 x 24 x 1.25	65	4	.15	\$146
PVET5L18	4.25 x 19.5 x 1.25	65	3	.12	\$140

T5 rapid start fluorescent lamp provides energy-efficient illumination. Slim low profile metal chassis. Electronic ballast. Prismatic acrylic lens included. Attaches to wood or metal units. Specify 6" shorter than storage unit width.

PLED30	1.5 x 15.5 x .5	150	2	.50	\$358
PLED50	1.5 x 23.5 x .5	150	2	.50	\$412
PLED100	1.5 x 43.5 x .5	125	3	.50	\$478

Energy efficient LED. Ultra slim design. Suitable for hanging under Hutch or Wallhung units. 6' power cord.

POWER / DATA



Cable Snake



Cable Snake Extension

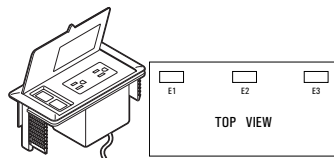

Power/Data Block



Mini Adapt Power Module

PCSN01	-- x -- x --	92.5	2.10	.20	\$96
--------	--------------	------	------	-----	-------------

Flexible cable management. Provides access to power/data from floor to underside of worksurface where it attaches. Two pathways within Cable Snake. Length under desk is 31.25". Silver (**SIL**) plastic only.

PCSN01E	- x - x -	92.5	2.1	0.2	\$76
---------	-----------	------	-----	-----	-------------

Extension kit to use with cable snake PCSN01. Additional 8 links extend cable snake up to 49" in length. Ideal for height adjustable tables. Silver plastic only.

PMSPDM	3.5 x 6.5 x 2.75	70	2	.10	\$238
--------	------------------	----	---	-----	--------------

Worksurface power and data module. Two power receptacles and two data receptacles. Specify position and add **\$65.00** for cutout in worksurface. See diagram E1/E2/E3 for specification location. Black (**BLK**) only.

PEUTEM	3 x 3.8 x 2	70	1	.18	\$159
--------	-------------	----	---	-----	--------------

Two power receptacles. Attaches to edge of table or desk through grommet hole. 6' black cord. Black (**BLK**) only.

POWER / DATA

MODEL#	DIMENSIONS D x W x H	FREIGHT CLASS	WT/LBS.	CUBIC FT.	LIST PRICE	HP ADD
PS305057	5.5 x 3.2 x 3	60	3.01	0.05	\$588	
PS305002	5.5 x 3.2 x 3	60	3.01	0.05	\$588	

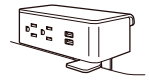

Edge Mounted 2 Power/USB

Edge mounted power module with two power outlets and two 2.1 amp USB ports. Edge clamp accommodates worksurfaces 0.5" to 1.5" thick; fastened with thumb screws.

PS305057 - White module with Silver bracket. PS305002 - Black module with Silver bracket



Under Mounted 2 Power/USB

PS305157	5.5 x 2.8 x 1.8	60	3.2	0.05	\$516	
PS305102	5.5 x 2.8 x 1.8	60	3.2	0.05	\$516	

Under mount power module with two power outlets and two 2.1 amp USB ports. Mountable under most worksurfaces. Installation template provided.

PS305157 - White module with Silver bracket. PS305102 - Black module with Silver bracket.

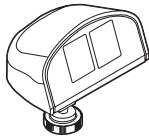

Power/Data Module

PEUTDM	3 x 3.75 x 2	92.5	2	.18	\$134	
--------	--------------	------	---	-----	--------------	--

Spaces for two Data Plugs with Common Adaptors. Attaches to edge of table or desk through grommet hole. 6' black cord. Black (**BLK**) only.

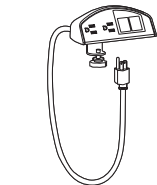

Power/Data Module

PEUEDM	4 x 6.5 x 2.5	92.5	2	.18	\$247	
--------	---------------	------	---	-----	--------------	--

Consisting of two electrical outlets, spaces for two data plugs with Adaptors, 6' power cord. Black (**BLK**) only.



Electrical/Communication Hub

PLECHUB	4.25 x 4.25 x 4.75	100	2	.25	\$579	
---------	--------------------	-----	---	-----	--------------	--

Circular component composed of two electrical outlets and two data outlets. Black (**BLK**) only.



Telecom Plate - 2 x 6

PTELO1	- x - x -	70	0.01	0.05	\$105	
--------	-----------	----	------	------	--------------	--

Includes 2 x RJ45 cat 6 data. Black telecom plate. To be hardwired by data contractor.

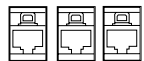

Telecom Plate - 3 x 6

PTELO2	- x - x -	70	0.01	0.05	\$133	
--------	-----------	----	------	------	--------------	--

Includes 2 x RJ45 cat 6 data and 1 RJ11 cat phone. Black telecom plate. To be hardwired by data contractor.

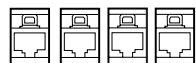

Telecom Plate - 4 x 6

PTELO3	- x - x -	70	0.01	0.05	\$204	
--------	-----------	----	------	------	--------------	--

Includes 4 x RJ45 cat 6 data. Black telecom plate. To be hardwired by data contractor.

POWER / DATA

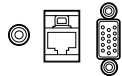

Telecom Plate - 3TSV

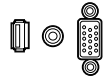

Telecom Plate - 3SVH

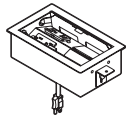

Power/USB Block

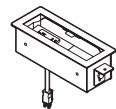

Power/USB Block

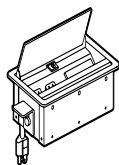

Power/Data Block

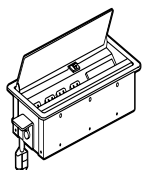

Power/Data Block

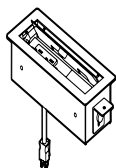

Voice/Data Block

MODEL#	DIMENSIONS	FREIGHT CLASS	WT/LBS.	CUBIC FT.	LIST PRICE	HP ADD
--------	------------	---------------	---------	-----------	------------	--------

D x W x H

PTEL04	- x - x -	70	0.01	0.05	\$182	
--------	-----------	----	------	------	--------------	--

Includes 1 x RJ45 cat 6 data, mini stereo and 15 pin HD VGA. Black telecom plate. To be hardwired by data contractor.

PTEL05	- x - x -	70	0.01	0.05	\$249	
--------	-----------	----	------	------	--------------	--

Includes mini stereo, 15 pin HD VGA and HDMI. Black telecom plate.

PM202USBB	11.02 x 6.77 x --	92.5	7	0.67	\$649	
PM202USBT	11.02 x 6.77 x --	92.5	7	0.67	\$649	

Conference table power module with recessed door. Includes one AC power simplex (one receptacle), one USB duplex (USB charging), one telecom knock out and one simplex on the bottom and 10' power cord. Box available in Black (B) or Tungsten (T) as indicated by last character of model number. Duplexes finish White only. Cut-out option K1, K2 or K3 to be specified when ordering boardroom table.

PM101USBB	11.02 x 4.33 x --	70	6	0.3	\$491	
PM101USBT	11.02 x 4.33 x --	70	6	0.3	\$491	

Conference table power module with recessed door. Includes one AC power simplex (one receptacle), one USB duplex (USB charging), one telecom knock out and one simplex on the bottom and 10' power cord. Box available in Black (B) or Tungsten (T) as indicated by last character of model number. Duplexes finish White only. Cut-out option K1, K2 or K3 to be specified when ordering boardroom table.

PLCTM101B	9 x 5.5 x -	70	6	0.3	\$209	
PLCTM101T	9 x 5.5 x -	70	6	0.33	\$209	

Power only included, specify telecom options separately, see above. Includes two simplex outlets on top and one on bottom. 10' cord. Includes one telecom knockout. Available in Black (B) and Tungsten (T) - indicated by last letter of model number. Surface access door.

PLCTM102B	12 x 5.5 x -	125	5	0.67	\$301	
PLCTM102T	12 x 5.5 x -	125	5	0.67	\$301	

Power only included, specify telecom options separately, see above. Includes four simplex outlets on top and one on bottom. 10' cord. Includes one telecom knockout. Available in Black (B) and Tungsten (T) - indicated by last letter of model number. Surface access door.

PLRTM101B	11 x 4.3 x --	125	4.65	0.67	\$399	
PLRTM101T	11 x 4.3 x --	125	4.65	0.67	\$399	

Power only included, specify telecom options separately. Includes two simplex outlets on top and one on bottom. 10' cord. Includes one telecom knockout. Available in Black (B) and Tungsten (T) - indicated by last letter of model number. Surface access door.

VOICE / DATA

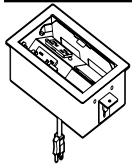

Voice/Data Block

MODEL#	DIMENSIONS	FREIGHT CLASS	WT/LBS.	CUBIC FT.	LIST PRICE
--------	------------	---------------	---------	-----------	------------

D x W x H

PLRTM202B	11 x 6.8 x --	92.5	7	0.67	\$463
PLRTM202T	11 x 6.8 x --	92.5	7	0.67	\$463

Power only included, specify telecom options separately. Includes four simplex outlets on top and one on bottom. 10' cord. Includes one telecom knockout. Available in Black (**B**) and Tungsten (**T**) - indicated by last letter of model number. Surface access door.

OFFICE ACCESSORIES

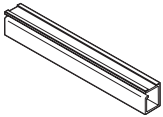

Wire Manager

PEWM5.5	2 x 66 x 2	70	.60	.10	\$142
PEWM5	2 x 60 x 2	70	.60	.10	\$119
PEWM4.5	2 x 54 x 2	70	.50	.10	\$106
PEWM4	2 x 48 x 2	70	.50	.10	\$96
PEWM3.5	2 x 42 x 2	70	.40	.10	\$83
PEWM3	2 x 36 x 2	70	.40	.10	\$73
PEWM2.5	2 x 30 x 2	70	.30	.10	\$60
PEWM2	2 x 24 x 2	70	.30	.10	\$50
PEWM1.5	2 x 18 x 2	70	.20	.10	\$37
PEWM1	2 x 12 x 2	70	.20	.10	\$27

Plastic tray flexes to receive and hold electrical and data wires. Quickly attaches with two strips of double-sided tape. Black (**BLK**) only.



Vertical Wire Manager

PEVWM	2 x 22 x 2	70	.30	.10	\$48
-------	------------	----	-----	-----	-------------

From underside of worksurface to bottom panel. Capable of holding electrical and data wires in a vertical position. Black (**BLK**) only. Attaches with two strips of double-sided tape.

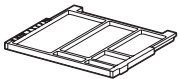

Pencil Drawer

PEEPD	18 x 22.5 x 1.5	250	2	.70	\$125
-------	-----------------	-----	---	-----	--------------

Provides storage for writing instruments and small items at the worksurface. Attaches to the underside of the worksurface with included drawer slides. Black ABS plastic.



Coat Tree

PCOS2	25 x 25 x 60	300	8	4.67	\$334
PCOS3	25 x 25 x 60	300	8	4.67	\$334

Square tube metal frame, complete with four Chrome double hooks. Adjustable glides. 60" high. Ships UPS.

- 3 per carton
- PCOS2 is finished in Black. PCOS3 is finished in Chrome.



Coat Tree

PCT	25 x 25 x 65	250	6	3	\$429
-----	--------------	-----	---	---	--------------

Square tube. Complete with four satin brass double hooks. 65" high. Available in the following finishes: Cherry (ACM), Honey (AHM), Maple (AVM), Black (BKM), English Oak (EOM), Mahogany (TMM), Fruitwood (TFM) and Walnut (TWM). Ships UPS.

- 1 per carton

Required Specifications

Finish (PCT only)

OFFICE ACCESSORIES



Whiteboard Easel

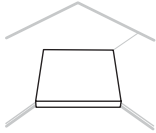

Corner Keyboard Plate

MODEL# DIMENSIONS FREIGHT CLASS WT/LBS. CUBIC FT. LIST PRICE

	D x W x H				
PEESL36	25 x 36 x 65.5	92.5	60	5.40	\$910
PEESL29	25 x 29 x 65.5	100	53	5.40	\$696

Double-sided whiteboard for use with any dry erase markers. Two Black (BLK) epoxy-coated 18 gauge steel A-Frame legs with locking casters. PVC tray holds markers and erasers. Also suitable for use as a presentation screen or privacy panel.

PEEOCKS	18 x 18 x 1.12	70	6	.30	\$82
---------	----------------	----	---	-----	-------------

Converts two 1" thick worksurfaces at 90° into a keyboard support corner. Finished in Black (BLK) and Tungsten 2 (TU2) epoxy coating.

DENVER BOOKCASES

BOOKCASE NOTES

- Available to either match or coordinate with most Global laminate desk series.

AWC	Avant Cherry	AWH	Avant Honey	BLK	Black	DES	Dark Espresso
GRY	Grey	QTM	Quartered Mahogany	TFW	Tiger Fruitwood	TMA	Tiger Mahogany
TMP	Tiger Maple	TWL	Tiger Walnut	WCR	Winter Cherry		

- Sturdy 36" wide construction.
- All units include fixed and adjustable shelves.
- Standard with Black finish back panel.

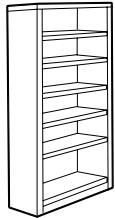

Denver Bookcase - 72" high

ZBC72	12 x 36 x 72	60	101	2.75	\$458
-------	--------------	----	-----	------	--------------

One fixed heavy duty shelf and four adjustable shelves. Shipped RTA (ready to assemble).

- All Denver Bookcases are standard with Black finish back panel.

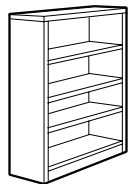

Denver Bookcase - 48" high

ZBC48	12 x 36 x 48	60	71	1.86	\$354
-------	--------------	----	----	------	--------------

Three adjustable shelves. Shipped RTA (ready to assemble).

- All Denver bookcases are standard with Black finish back panel.

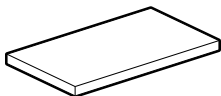

Bookcase Shelf

ZESH	12 x 34 x 1	60	10	.30	\$96
------	-------------	----	----	-----	-------------

Extra shelf for bookcases. 1" thick.

Required Specifications

Finish

BOARDROOM ACCESSORIES	MODEL#	DIMENSIONS D x W x H	FREIGHT CLASS	WT/LBS.	CUBIC FT.	LIST PRICE
-----------------------	--------	-------------------------	---------------	---------	-----------	------------

CONFERENCE CABINET NOTES

- Visual boards feature a self edge all around.
- Available finishes:

ACJ	Absolute Acajou	ASN	Asian Night	AWC	Avant Cherry	AWH	Avant Honey
BLK	Black	BRC	Brushed Cobalt	CSJ	Constellation Java	DES	Dark Espresso
HGT	Hayden Grey (Taupe)	QTM	Quartered Mahogany	SKC	Shaker Cherry	SOG	Storm Grey
TFW	Tiger Fruitwood	TMA	Tiger Mahogany	TMP	Tiger Maple	TWL	Tiger Walnut
WHT	White	WHC	White Chocolate	WGY	Willow Grey	WCR	Winter Cherry

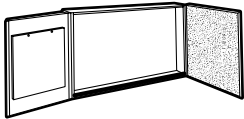

Visual Board

GVB4848	4 x 48 x 48	85	122	9.25	\$1200
AVB4848	4 x 48 x 48	70	135	9	\$1203

Includes white board and two side opening doors containing cork board on right door and 50-sheet paper writing pad on left door. Marker board can be used for projection. Set of 4 dry markers and eraser included.

- **NOTE:** Care should be taken to mount the units. Units should be mounted to wall studs using correct fasteners. Failure to do so may result in collapse of the unit and subsequent personal injury. **Mounting hardware not included.** Mounting hardware used should be based on wall material. Consult an installation professional for proper wall mounting.

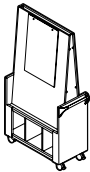

Visual Board

Z361872VB	36 x 18 x 72	250	187	38.50	\$2094
-----------	--------------	-----	-----	-------	---------------

Angled visual board with paper pad on one side and dry erase board on the opposite side. Unique push handles are standard. Locking casters included. Decorative aluminum trim is standard on the lip of each shelf. Height aligns with 36" buffets. Shipped RTA (ready to assemble).

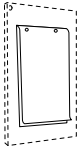

Flip Chart Pad

FC	30 x 20 x 30	92.5	20	2	\$277
----	--------------	------	----	---	--------------

Additional flip chart paper for double door visual boards. 50 sheets per book. Five pads per package. Price is per package.

PENCIL DRAWERS

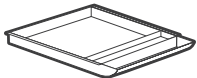

Pencil Drawer

W1624PDR	16 x 24 x 2.25	92.5	5	.50	\$256
W1518PDR	18 x 15 x 2.25	92.5	4	.40	\$192

Black ABS plastic. Provides space for writing instruments and small items at the workspace. Attaches to underside of any 24"D and 30"D worksurface with included roller slides. Shipped RTA (ready to assemble).

- May be used with all casegoods.

Required Specifications

Finish (Visual Board)

CENTER DRAWERS

MODEL#

DIMENSIONS

FREIGHT CLASS

WT/LBS.

CUBIC FT.

LIST PRICE

D x W x H

CENTER DRAWER NOTES

• Center drawers must be dealer or end user installed. Drawers do not fill entire center space opening. Approximate kneespace widths are:

30" x 60" DP	25½"	30" x 66" DP	31½"
30" x 72" DP	37½"	30" x 66"/20" x 40" L	22½"
30" x 66"/24" x 48" L	24½"	36" x 72"/24" x 48" L	30½"

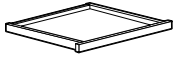

Center Drawer

CD20	18 x 20 x 3	100	8	1	\$150
------	-------------	-----	---	---	--------------

Laminate drawer front is attached to a 4-sided frame. Recommended for use on small L-shaped units, and on 30" x 60" and 30" x 66" desks. Specify finish from list available in each series.

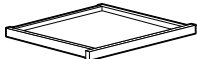

Center Drawer

CD28	18 x 28 x 23	150	5	1	\$197
------	--------------	-----	---	---	--------------

Laminate drawer front is attached to a 4-sided frame. Recommended for use on 36" x 72" desks. Specify finish from list available in each series.

KEYBOARD DRAWERS

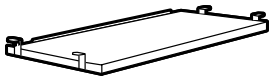

Keyboard Shelf

KS20	11 x 20 x 3.5	92.5	10	1	\$187
------	---------------	------	----	---	--------------

Pull-out laminate shelf. Specify finish from list available in each series.

• **Not available** on StreamLINE or Adaptabilities Series - see page 41 for comparable Adaptabilities option.

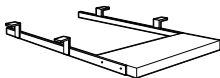

Keyboard Drawer

MPOKL	11 x 24 x 21	92.5	10	1	\$192
-------	--------------	------	----	---	--------------

Pull-out laminate drawer. Specify finish from list available in each series.

• **Not available** on StreamLINE or Adaptabilities Series - see page 41 for comparable Adaptabilities option.

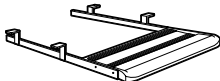

Softouch™ Keyboard Drawer with Palm Rest

MPOKST2	11 x 24 x 21	92.5	10	1	\$299
---------	--------------	------	----	---	--------------

Pull-out keyboard. Recessed tray with palm rest. Recessed keyboard area is 9" d x 21¼" w x 1¼" h. **Black only.**

• **Not available** on StreamLINE Series

ACCESSORIES



Wire Manager Grommet

AG1	1.875 d x 3.25 w	100	--	--	\$65
AG2					
AG3					

Rectangular **black** surface mount that can be factory installed in any worksurface. Indicate position - left (**AG1**), center (**AG2**) or right (**AG3**). **See individual Series Notes for further details.**

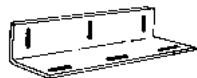

L Bracket

MLB90	--	70	1	.01	\$39
-------	----	----	---	-----	-------------

Used to attach worksurfaces to end panels.

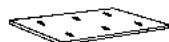

Flat Bracket

M393	--	70	1	.01	\$36
------	----	----	---	-----	-------------



Used as a mending plate to give additional worksurface support.

Required Specifications

Finish (Drawers)

D DESK ACCESSORIES

DRAWER HANDLES

	MODEL#	DIMENSIONS D x W x H	FREIGHT CLASS	WT/LBS.	CUBIC FT.	LIST PRICE
 <p>Silver Handle (HV)</p>	GEN225-SIL	--	70	1	.01	\$21
<p>Silver finish, square edge handle style. For use on pedestals and all lateral files.</p> <ul style="list-style-type: none"> This handle has a measurement of 96mm center to center. Drawer handles on this page are for purchase. Installation is done by the customer. To purchase as a factory installed option on Zira or Correlation desks, credenzas and returns, see series notes for option code and price. 						
 <p>Matte Black Handle (HU)</p>	GEN225-BLK	--	70	1	.01	\$21
<p>Black matte finish, square edge handle style. For use on pedestals and all lateral files.</p> <ul style="list-style-type: none"> This handle has a measurement of 96mm center to center. Drawer handles on this page are for purchase. Installation is done by the customer. To purchase as a factory installed option on Zira or Correlation desks, credenzas and returns, see series notes for option code and price. 						
 <p>Flared Brass Handle (HW)</p>	GEN217	--	70	1	.01	\$21
<p>Satin brass finish, flared handle style. For use on pedestals and all lateral files.</p> <ul style="list-style-type: none"> This handle has a measurement of 96mm center to center. Drawer handles on this page are for purchase. Installation is done by the customer. To purchase as a factory installed option on Zira or Correlation desks, credenzas and returns, see series notes for option code and price. 						
 <p>Flared Black Handle (HX)</p>	GEN165	--	70	1	.01	\$21
<p>Black matte finish, flared handle style. For use on pedestals and all lateral files.</p> <ul style="list-style-type: none"> This handle has a measurement of 96mm center to center. Drawer handles on this page are for purchase. Installation is done by the customer. To purchase as a factory installed option on Zira or Correlation desks, credenzas and returns, see series notes for option code and price. 						
 <p>Bow Handle (HS)</p>	GEN189-HS	--	70	1	.01	\$21
<p>Silver finish, bow handle style. For use on pedestals and all lateral files.</p> <ul style="list-style-type: none"> This handle has a measurement of 96mm center to center. Drawer handles on this page are for purchase. Installation is done by the customer. To purchase as a factory installed option on Zira or Correlation desks, credenzas and returns, see series notes for option code and price. 						
 <p>Dimpled Nickel Handle (HZ)</p>	GEN190	--	70	1	.01	\$21
<p>Nickel matte finish, dimpled handle style. For use on pedestals and all lateral files.</p> <ul style="list-style-type: none"> This handle has a measurement of 96mm center to center. Drawer handles on this page are for purchase. Installation is done by the customer. To purchase as a factory installed option on Zira or Correlation desks, credenzas and returns, see series notes for option code and price. 						
 <p>Crescent Black Handle (H0)</p>	GEN256	--	70	1	.01	\$21
<p>Black matte finish, crescent handle style. For use on pedestals and all lateral files.</p> <ul style="list-style-type: none"> This handle has a measurement of 96mm center to center. Drawer handles on this page are for purchase. Installation is done by the customer. To purchase as a factory installed option on Zira desks, credenzas and returns only, see series notes for option code and price. 						

DRAWER HANDLES

MODEL# DIMENSIONS FREIGHT CLASS WT/LBS. CUBIC FT. LIST PRICE

D x W x H



Bar Silver Handle (HQ)

CS0003-SIL	--	70	1	.01	\$21
------------	----	----	---	-----	-------------

Silver finish, bar handle style **For use on pedestals and all lateral files.**

- This handle has a measurement of 96mm center to center.
- Drawer handles on this page are for purchase. Installation is done by the customer. To purchase as a factory installed option on **Zira desks, credenzas and returns only**, see series notes for option code and price.



Bar Black Handle (HR)

CS0003-BLK	--	70	1	.01	\$21
------------	----	----	---	-----	-------------

Black finish, bar handle style **For use on pedestals and all lateral files.**

- This handle has a measurement of 96mm center to center.
- Drawer handles on this page are for purchase. Installation is done by the customer. To purchase as a factory installed option on **Zira desks, credenzas and returns only**, see series notes for option code and price.

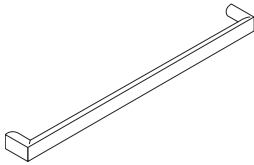

Bridges II Handle

BRH1	--	70	1	.01	\$21
------	----	----	---	-----	-------------

Silver Finish, square edged handle style. For use on all pedestals and storage cabinets with handles.

- This handle has a measurement of 128mm center to center.
- Drawer handles on this page are for purchase. Installation is done by the customer. To purchase as a factory installed option on **Bridges II pedestals and cabinets only**, see series notes for option code and price.

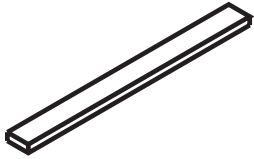

Princeton Handle

PNHAND	--	70	1	.01	\$21
--------	----	----	---	-----	-------------

Silver Finish, extended bar handle style. For use on all pedestals, lateral files and storage cabinets with handles.

- This handle has a measurement of 224mm center to center.
- Drawer handles on this page are for purchase. Installation is done by the customer. To purchase as a factory installed option on **Princeton pedestals, lateral files and storage cabinets only**, see series notes for option code and price.

T TABLE POWER + TECHNOLOGY SOLUTIONS™ - NOTES

- Global is pleased to offer a range of sophisticated electrical and technology options for training and conference tables.
- Worksurface cutouts for units must be specified separately, please see appropriate product note pages for details.
- Daisy chaining is generally defined as having multiple power units connect to one another from a single electrical infeed source.
- The daisy-chain units below utilize a 4-wire, 2 circuit system (when hardwired by a licensed electrician to a building power source) or can run a single circuit (when utilizing the 42AP1-72 plug and play infeed).
- The following maximums are to National Electric Code (NEC) – some local codes vary from NEC code – it is the customer's responsibility to follow all applicable local codes and guidelines.

Product	Max units per circuit
Villa I	8 units per circuit
Villa II	4 units per circuit
Oasis Mini A	3 units per circuit
Oasis Mini B	3 units per circuit

Electrical System

4-2 Wiring Schematic
 4-Wire Shared Neutral
 Complies with National Electric Code
 UL Listed
 All circuits rated for 20 AMP

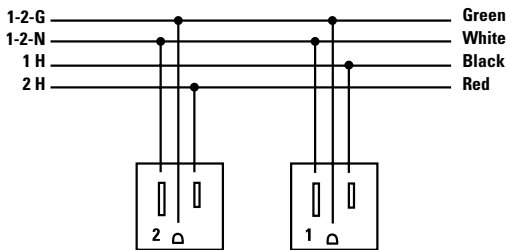

VILLA CUTOUTS

- Optional Villa cutout available in standard worksurface locations (left, center or right) **for Rectangular Tables**. Order as: **V1, V2 or V3.....Add \$65 for each cutout.**
- Villa cutouts may be placed at non-standard locations. Please contact customer service.
- **Villa is only available on Bungee, Junction and Connectables series**

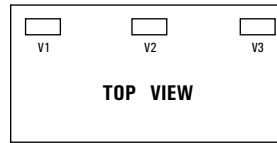

OASIS MINI CUTOUTS

- Optional Oasis Mini cutout available in standard worksurface locations (left, center or right) **for Rectangular Tables**. Order as: **M1, M2 or M3.....Add \$65 for each cutout.**
- Oasis Mini cutouts may be placed at non-standard locations. Please contact customer service.
- **Oasis Mini is only available on Zira Boardroom Tables**

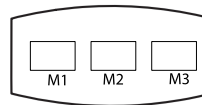

EXAMPLE LAYOUTS - TRAINING TABLES

- Single Power Block Kits Available on training tables 36" – 72" (**must specify V2 cutout on table**):
- Each single block kit includes 1 Power Block and 1 Grommet Cover, 1 Female/Female Interconnecting Cable and 1 Female/Male Interconnecting Cable. Cable clamps for management of these cables are also included.

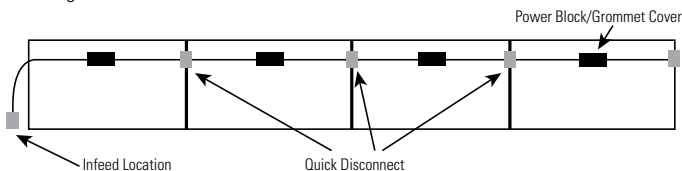

- Double Power Block Kits Available on 60", 66" and 72" (**must specify V1 and V3 cutout on table**):
- Each double block kit includes 2 Power Blocks and 2 Grommet Covers, 2 Female/Female Interconnecting Cable and 1 Female/Male Interconnecting Cable. Cable clamps for management of these cables are also included.

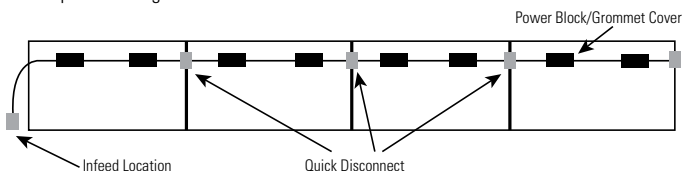

VILLA I SERIES CENTER POWER - SINGLE BLOCK KITS **MODEL#** **DIMENSIONS** **FREIGHT CLASS** **WT/LBS.** **CUBIC FT.** **LIST PRICE**

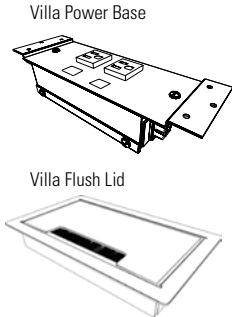

Data Knockouts, No Data Ports

	D x W x H				
VIF-41-DKO_72SK	--	70	9	.45	\$371
VIF-41-DKO_66SK	--	70	9	.45	\$371
VIF-41-DKO_60SK	--	70	9	.45	\$371
VIF-41-DKO_54K	--	70	9	.45	\$371
VIF-41-DKO_48K	--	70	9	.45	\$371
VIF-41-DKO_42K	--	70	9	.45	\$371
VIF-41-DKO_36K	--	70	9	.45	\$371

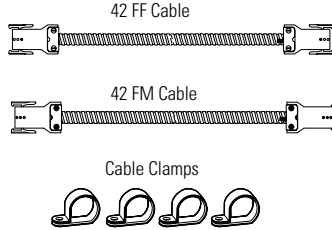

Includes **one power block** with **two power receptacles** and two knockouts for data, grommet cover, one female/female interconnecting cable, one female/male interconnecting cable and four cable clamps. **V2 cutout must be specified on training table** (see product notes section for more details and cutout upcharge). **Power Infeed required and sold separate** (see page 518). For multiple circuit configurations, please contact customer service. UL listed and CSA Certified.

- Replace _ with **B** for **Black**
- Replace _ with **S** for **Silver Pearl**

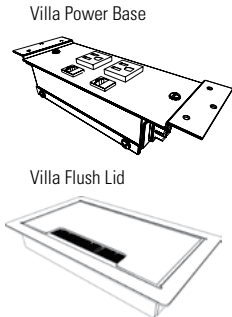

Data Knockouts, Data Ports Included

VIF-41-D_-72SK	--	70	9	.45	\$487
VIF-41-D_-66SK	--	70	9	.45	\$487
VIF-41-D_-60SK	--	70	9	.45	\$487
VIF-41-D_-54K	--	70	9	.45	\$487
VIF-41-D_-48K	--	70	9	.45	\$487
VIF-41-D_-42K	--	70	9	.45	\$487
VIF-41-D_-36K	--	70	9	.45	\$487

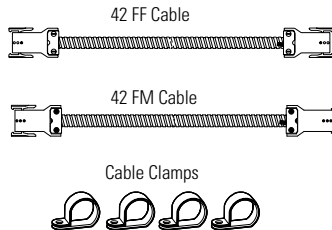

Includes **one power block** with **two power receptacles** and **two RJ45** Cat 6 Data, grommet cover, one female/female interconnecting cable, one female/male interconnecting cable and four cable clamps. **V2 cutout must be specified on training table** (see product notes section for more details and cutout upcharge). **Power Infeed required and sold separate** (see page 518). For multiple circuit configurations, please contact customer service. UL listed and CSA Certified.

- Replace _ with **B** for **Black**
- Replace _ with **S** for **Silver Pearl**

Required Specifications
 Finish
 Power Infeed
 Cutout location

T TABLE POWER + TECHNOLOGY SOLUTIONS

VILLA II SERIES CENTER POWER - SINGLE BLOCK KITS	MODEL#	DIMENSIONS	FREIGHT CLASS	WT/LBS.	CUBIC FT.	LIST PRICE
		D x W x H				
	VIF2-41-DKO_72SK	--	65	12	.45	\$440
	VIF2-41-DKO_66SK	--	65	12	.45	\$440
	VIF2-41-DKO_60SK	--	65	12	.45	\$440
	VIF2-41-DKO_54K	--	65	12	.45	\$440
	VIF2-41-DKO_48K	--	65	12	.45	\$440
	VIF2-41-DKO_42K	--	65	12	.45	\$440
	VIF2-41-DKO_36K	--	65	12	.45	\$440

Villa II Power Base

Villa II Flush Lid

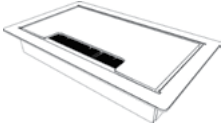
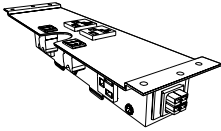

Data Knockouts, No Data Ports



Includes **one power block** with **four power receptacles** (two worksurface accessible, two below worksurface) and two knockouts for data, grommet cover, one female/female interconnecting cable, one female/male interconnecting cable and four cable clamps. **V2 cutout must be specified on training table** (see product notes section for more details and cutout upcharge). **Power Infeed required and sold separate** (see page 518). For multiple circuit configurations, please contact customer service. UL listed and CSA Certified.

- Replace _ with **B** for **Black**
- Replace _ with **S** for **Silver Pearl**

VIF2-41-D_-72SK	--	65	12	.45	\$556
VIF2-41-D_-66SK	--	65	12	.45	\$556
VIF2-41-D_-60SK	--	65	12	.45	\$556
VIF2-41-D_-54K	--	65	12	.45	\$556
VIF2-41-D_-48K	--	65	12	.45	\$556
VIF2-41-D_-42K	--	65	12	.45	\$556
VIF2-41-D_-36K	--	65	12	.45	\$556

Villa II Power Base

Villa II Flush Lid

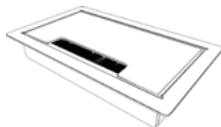
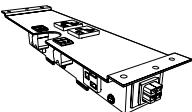

Data Knockouts, Data Ports Included

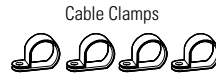
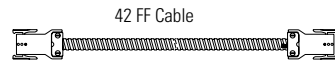

Includes **one power block** with **four power receptacles** (two worksurface accessible, two below worksurface) and **two RJ45 Cat 6 Data**, grommet cover, one female/female interconnecting cable, one female/male interconnecting cable and four cable clamps. **V2 cutout must be specified on training table** (see product notes section for more details and cutout upcharge). **Power Infeed required and sold separate** (see page 518). For multiple circuit configurations, please contact customer service. UL listed and CSA Certified.

- Replace _ with **B** for **Black**
- Replace _ with **S** for **Silver Pearl**

Required Specifications

Finish
Power Infeed
Cutout location

VILLA I SERIES DOUBLE BLOCK KITS

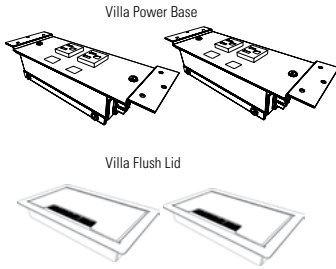

Data Knockouts, No Data Ports

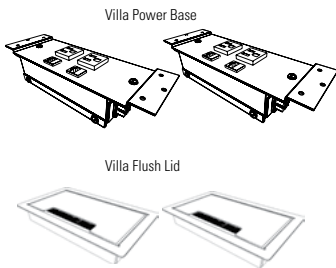

Data Knockouts, Data Ports Included

MODEL#	DIMENSIONS	FREIGHT CLASS	WT./LBS.	CUBIC FT.	LIST PRICE
--------	------------	---------------	----------	-----------	------------

	D x W x H				
GL-VIF41KO_72DK	--	60	18	.23	\$695
GL-VIF41KO_66DK	--	60	18	.23	\$695
GL-VIF41KO_60DK	--	60	18	.23	\$695

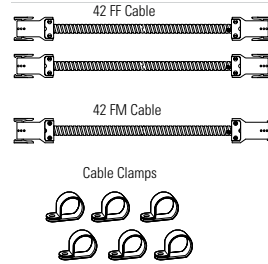

Includes **two power blocks** with **two power receptacles** and two knockouts for data in each block, two grommet covers, two female/female interconnecting cable, one female/male interconnecting cable and 6 cable clamps. **V1 & V3 cutouts must be specified on training table** (see product notes section for more details and cutout upcharge). **Power Infeed required and sold separate** (see page 518). For multiple circuit configurations, please contact customer service. UL listed and CSA Certified.

- Replace _ with **B** for **Black**
- Replace _ with **S** for **Silver Pearl**

GL-VIF41D_72DK	--	60	18	.23	\$718
GL-VIF41D_66DK	--	60	18	.23	\$718
GL-VIF41D_60DK	--	60	18	.23	\$718

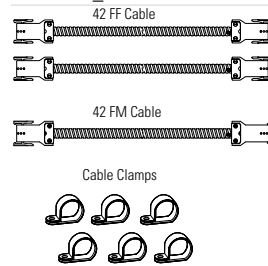

Includes **two power blocks** with **two power receptacles** and **two RJ45** Cat 6 data in each block, two grommet covers, two female/female interconnecting cable, one female/male interconnecting cable and 6 cable clamps. **V1 & V3 cutouts must be specified on training table** (see product notes section for more details and cutout upcharge). **Power Infeed required and sold separate** (see page 518). For multiple circuit configurations, please contact customer service. UL listed and CSA Certified.

- Replace _ with **B** for **Black**
- Replace _ with **S** for **Silver Pearl**

Required Specifications

Finish
Power Infeed
Cutout location

T TABLE POWER + TECHNOLOGY SOLUTIONS

VILLA II SERIES DOUBLE BLOCK KITS

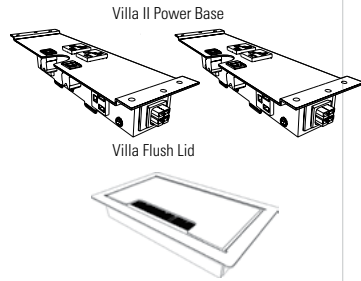

Data Knockouts, No Data Ports

MODEL#	DIMENSIONS D x W x H	FREIGHT CLASS	WT./LBS.	CUBIC FT.	LIST PRICE
GLVIF241KO_72DK	--	60	22	.23	\$741
GLVIF241KO_66DK	--	60	22	.23	\$741
GLVIF241KO_60DK	--	60	22	.23	\$741

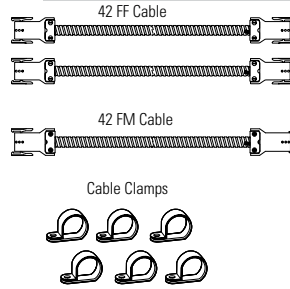

Includes **two power blocks** with **four power receptacles** (two worksurface accessible, two below worksurface) and two knockouts for data in each block, two grommet covers, two female/female interconnecting cable, one female/male interconnecting cable and 6 cable clamps. **V1 & V3 cutouts must be specified on training table** (see product notes section for more details and cutout upcharge). **Power Infeed required and sold separate** (see page 518). For multiple circuit configurations, please contact customer service. UL listed and CSA Certified.

- Replace _ with **B** for **Black**
- Replace _ with **S** for **Silver Pearl**

GL-VIF241D_72DK	--	60	22	.23	\$973
GL-VIF241D_66DK	--	60	22	.23	\$973
GL-VIF241D_60DK	--	60	22	.23	\$973

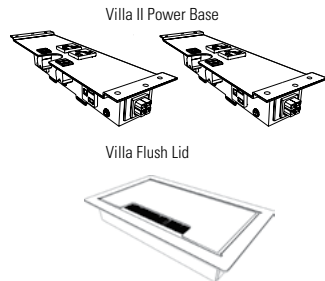

Data Knockouts, Data Ports Included

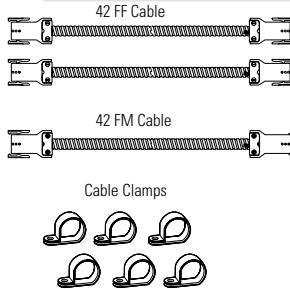

Includes **two power blocks** with **four power receptacles** (two worksurface accessible, two below worksurface) and **two RJ45** Cat 6 data in each block, two grommet covers, two female/female interconnecting cable, one female/male interconnecting cable and 6 cable clamps. **V1 & V3 cutouts must be specified on training table** (see product notes section for more details and cutout upcharge). **Power Infeed required and sold separate** (see page 518). For multiple circuit configurations, please contact customer service. UL listed and CSA Certified.

- Replace _ with **B** for **Black**
- Replace _ with **S** for **Silver Pearl**

VILLA I SERIES CORDED UNITS

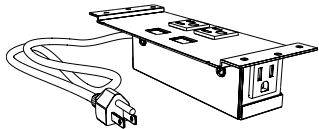

Data Knockouts, No Data Ports

MODEL#	DIMENSIONS D x W x H	FREIGHT CLASS	WT./LBS.	CUBIC FT.	LIST PRICE
VIL-C-DKO_-108	3.25 x 8.75 x 2.25	100	4	.45	\$186
VIL-C-DKO_-72	3.25 x 8.75 x 2.25	100	4	.45	\$186

Villa I with 3-prong plug. Includes **two power receptacles** and two knockouts for data. A third convenience receptacle is provided below the worksurface. **V1, V2 or V3 cutout(s) must be specified on training table** (see product notes section for more details and cutout upcharge). **Grommet cover is required and sold separate** (see next page). UL/CUL listed.

- Replace _ with **B** for **Black**
- Replace _ with **S** for **Silver Pearl**
- -108 models include a 108" long cord. -72 models include a 72" long cord.

Required Specifications

Finish
Power Infeed
Cutout location

VILLA I SERIES CORDED UNITS

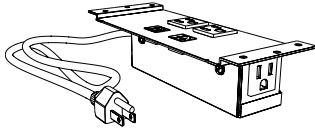

Data Knockouts, Data Ports Included

MODEL#	DIMENSIONS	FREIGHT CLASS	WT/LBS.	CUBIC FT.	LIST PRICE
D x W x H					
VIL-C-D-_-108	3.25 x 8.75 x 2.25	100	4	.45	\$301
VIL-C-D-_-72	3.25 x 8.75 x 2.25	100	4	.45	\$301

Villa I with 3-prong plug. Includes **two power receptacles** and **two RJ45** Cat 6 data. A third convenience receptacle is provided below the worksurface. **V1, V2 or V3 cutout(s) must be specified on training table** (see product notes section for more details and cutout upcharge). **Grommet cover is required and sold separate** (see below). UL/CUL listed.

- Replace _ with **B** for **Black**
- Replace _ with **S** for **Silver Pearl**

VILLA II SERIES CORDED UNITS

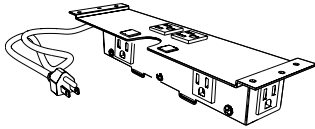

Data Knockouts, No Data Ports

VIL2-C2-DKO_-108	3.25 x 11 x 2.25	85	6	.45	\$255
VIL2-C2-DKO_-72	3.25 x 11 x 2.25	85	6	.45	\$255

Villa II with 3-prong plug. Includes **four power receptacles** (two worksurface accessible, two below worksurface) and two knockouts for data. A fifth convenience receptacle is provided below the worksurface. **V1, V2 or V3 cutout(s) must be specified on training table** (see product notes section for more details and cutout upcharge). **Grommet cover is required and sold separate** (see below). UL/CUL listed.

- Replace _ with **B** for **Black**
- Replace _ with **S** for **Silver Pearl**

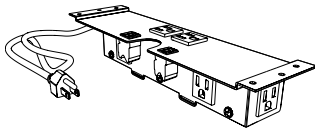

Data Knockouts, Data Ports Included

VIL2-C2-D_-108	3.25 x 11 x 2.25	85	6	.45	\$371
VIL2-C2-D_-72	3.25 x 11 x 2.25	85	6	.45	\$371

Villa II with 3-prong plug. Includes **four power receptacles** (two worksurface accessible, two below worksurface) and **two RJ45** Cat 6 data. A fifth convenience receptacle is provided below the worksurface. **V1, V2 or V3 cutout(s) must be specified on training table** (see product notes section for more details and cutout upcharge). **Grommet cover is required and sold separate** (see below). UL/CUL listed.

- Replace _ with **B** for **Black**
- Replace _ with **S** for **Silver Pearl**

VILLA GROMMET COVERS

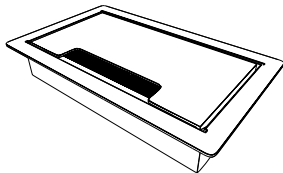

Villa Grommet Cover

VIL-GROM-F-__	3.5 x 5.75 x .94	70	1	.08	\$93
---------------	------------------	----	---	-----	-------------

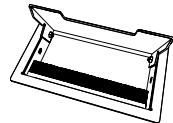

Powder coated flush metal grommet to be used with Villa I and Villa II **corded** series power blocks. Cutouts in tables must be specified separately. **V1, V2 or V3 cutout(s) must be specified on training table** (see product notes section for more details and cutout upcharge). **Grommet cover remains open while in use.**

- **Cannot be used with PMSPDM.**
- Replace _ with **B** for **Black**
- Replace _ with **S** for **Silver Pearl**

Required Specifications

Finish
Power Infeed
Cutout location

T TABLE POWER + TECHNOLOGY SOLUTIONS

OASIS MINI

MODEL#	DIMENSIONS	FREIGHT CLASS	WT./LBS.	CUBIC FT.	LIST PRICE
D x W x H					
OAM-A-PC-__	15 x 9 x 5.25	92.5	16	1.53	\$1375
					
<p>Oasis Mini A, Corded</p> <p>Mini Oasis A unit. 15" Trough with six power receptacles, two telecom plate cutouts (telecom plates sold separate, see next page) and two 108" 3-prong plugs. M1, M2 or M3 cutout(s) must be specified on conference table (see product notes section for more details and cutout upcharge). UL Listed.</p> <ul style="list-style-type: none"> • Cannot be daisy-chained. • Replace _ with B for Black • Replace _ with S for Silver Pearl 					
					
<p>Oasis Mini A, DaisyLink Version</p> <p>For hardwire and daisy chain applications. Mini Oasis A unit. 15" Trough with six power receptacles, two telecom plate cutouts (telecom plates sold separate, see next page). Power infeed sold separate (see page 518). M1, M2 or M3 cutout(s) must be specified on conference table (see product notes section for more details and cutout upcharge). For multiple circuit configurations, please contact customer service. <i>Please see our Daisy-Chain guide on page 519 for appropriate cable lengths and important notes.</i> UL Listed.</p> <ul style="list-style-type: none"> • Replace _ with B for Black • Replace _ with S for Silver Pearl 					
					
<p>Oasis Mini B, Corded</p> <p>Mini Oasis B unit. 15" Trough with four power receptacles, three telecom plate cutouts (telecom plates sold separate, see next page) and one 108" 3-prong plug. M1, M2 or M3 cutout(s) must be specified on conference table (see product notes section for more details and cutout upcharge). UL Listed.</p> <ul style="list-style-type: none"> • Cannot be daisy-chained. • Replace _ with B for Black • Replace _ with S for Silver Pearl 					
					
<p>Oasis Mini B, DaisyLink Version</p> <p>For hardwire and daisy chain applications. Mini Oasis B unit. 15" Trough with four power receptacles, three telecom plate cutouts (telecom plates sold separate, see next page). Power infeed sold separate (see page 518). M1, M2 or M3 cutout(s) must be specified on conference table (see product notes section for more details and cutout upcharge). For multiple circuit configurations, please contact customer service. <i>Please see our Daisy-Chain guide on page 519 for appropriate cable lengths and important notes.</i> UL Listed.</p> <ul style="list-style-type: none"> • Replace _ with B for Black • Replace _ with S for Silver Pearl 					
					
<p>Oasis Mini, Chicago Code</p> <p>Mini Oasis for Chicago code includes electrical trough with (2) separate hardwire inserts. Each insert includes (3) simplex outlets and (1) telecom plate cutout (telecom plates sold separate - see next page). M1, M2 or M3 cutout(s) must be specified on conference table (see product notes section for more details and cutout upcharge). Each component is UL listed.</p> <ul style="list-style-type: none"> • Cannot be daisy-chained. • Replace _ with B for Black • Replace _ with S for Silver Pearl 					















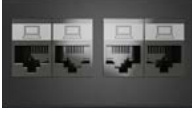

Required Specifications

Finish
Power Infeed
Cutout location

TOP TELECOM PLATES

D x W x H

TOP TELECOM PLATE	MODEL	CONFIGURATION	LIST PRICE
	A-__-A-B	Telecom plate with RJ11 Cat 3 Phone and RJ45 Cat 6 Data	\$80
	A-__-B-B	(2) RJ45 Cat 6 Connectors	\$105
	A-__-B-B-B	(3) RJ45 Cat 6 Connectors	\$154
	A-__-B-B-B-B	(4) RJ45 Cat 6 Connectors	\$204
	A-__-B-C51-L	RJ45 Cat 6 Data, Mini-Stereo Inline and 15 pin HD VGA Female/Female with 72" patch cord attached.	\$182
	A-__-B-B-C51	(2) RJ45 Cat 6 Data and (1) 15 pin HD VGA Female/Female with 72" patch cord attached.	\$190
	A-__-A-B-102	RJ11 Cat 3 phone, RJ45 Cat 6 Data and USB with 72" patch cord attached.	\$182
	A-__-B	RJ45 Cat 6 Data	\$55
	A-__-C51-L	Mini Stereo Inline and 15 pin HD VGA Female/Female with 72" patch cord attached.	\$142
	A-__-CRDMINDER	Cordminder Plate - 2 5/8" holes and 1 7/8" holes	\$31
	A-__-C45-C51-L	HDMI Female/Female with 36" patch cord attached. Mini Stereo Inline and 15 Pin HD VGA Female/Female with 72" patch cord attached.	\$249





Required Specifications

Finish
Power Infeed
Cutout location

T TABLE POWER + TECHNOLOGY SOLUTIONS

TOP TELECOM PLATES

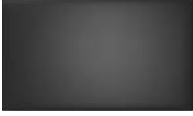
D x W x H

TOP TELECOM PLATE	MODEL	CONFIGURATION	LIST PRICE
	A-__-C45	HDMI Female/Female with 36" patch cord attached.	\$122
	A-__-A-B-B	(1) RJ11 Cat 3 Phone and (2) RJ45 Cat 6 data.	\$133
	A-__	Blank telecom plate	\$6
	A-__-102	USB with 72" patch cord attached.	\$55
	A-__-C51	15 pin HD VGA Female/Female with 72" patch cord attached.	\$91

- Replace __ with **BL** for **Black**
- Replace __ with **GR** for **Grey**

POWER INFEEDS

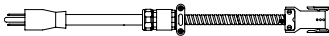

Plug and Play Infeed

42AP1-72	--	--	--	--	\$183
----------	----	----	----	----	--------------

Single Circuit 20 AMP Power Infeed with 72" 3-prong plug. Provides single power entry from floor or wall mounted standard power supply. Connects to Oasis Mini or Villa units that require a separate infeed. UL Listed.



Multi-Circuit Hardwire Power Infeed

42SB2-108	--	--	--	--	\$151
42SB2-72	--	--	--	--	\$118
42SB2-36	--	--	--	--	\$85

Multi-Circuit Hardwire Infeed (up to 20 AMPS per circuit), two circuits. Provides single power entry from floor or wall located building power supply. Connects to Oasis Mini or Villa units that require a power infeed. **TO BE HARDWIRED BY A LICENSED ELECTRICIAN.** UL Listed.

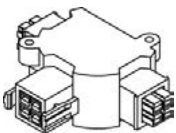

3 Way Power Splitter

DAISY-T	--	70	1	1	\$139
---------	----	----	---	---	--------------

Daisy-T power manager includes two male and one female connection. For use in splitting a power source two ways.

Required Specifications

Finish
Power Infeed
Cutout location

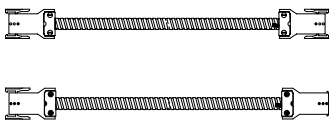

Interconnecting Cables

42FF-_____
 Female/Female
 42FM-_____
 Female/Male

UL Listed and CSA Certified. **For appropriate quantity and sizes, please refer to the chart on the next page.**

Interconnecting Cables - Common Cable Lengths (in inches)

Female/Female		Female/Male	
42FF-21.....	\$80	42FM-12.....	\$76
42FF-29.....	\$88	42FM-21.....	\$85
42FF-32.....	\$90	42FM-32.....	\$95
42FF-37.....	\$95	42FM-46.....	\$108
42FF-41.....	\$99	42FM-55.....	\$116
42FF-46.....	\$103	42FM-58.....	\$119
42FF-52.....	\$109	42FM-67.....	\$127
42FF-55.....	\$112	42FM-70.....	\$130
42FF-58.....	\$114	42FM-79.....	\$138
42FF-61.....	\$117	42FM-82.....	\$141
42FF-64.....	\$120	42FM-91.....	\$150
42FF-67.....	\$123	42FM-94.....	\$151
42FF-70.....	\$125	42FM-103.....	\$161
42FF-76.....	\$131	42FM-106.....	\$163
42FF-79.....	\$134	42FM-115.....	\$172
42FF-82.....	\$137	42FM-118.....	\$175
42FF-85.....	\$139		
42FF-88.....	\$142		
42FF-91.....	\$145		
42FF-94.....	\$148		
42FF-100.....	\$153		
42FF-103.....	\$156		
42FF-106.....	\$158		
42FF-112.....	\$164		
42FF-115.....	\$167		
42FF-118.....	\$170		

DRAWING 1A - MINI OASIS A

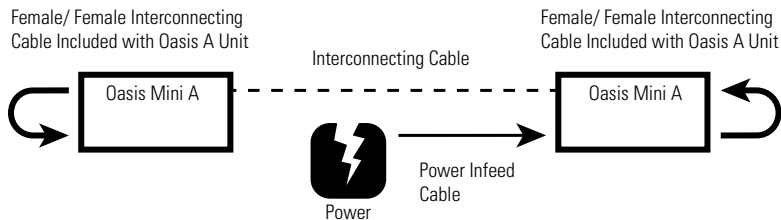

DRAWING 1B - MINI OASIS B

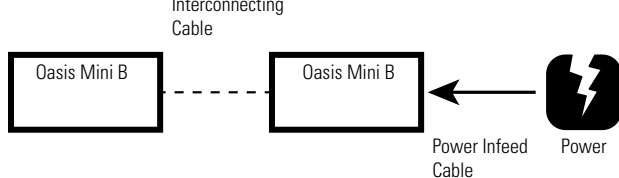

T TABLE POWER + TECHNOLOGY SOLUTIONS - NOTES

DRAWING 2A - MINI OASIS A

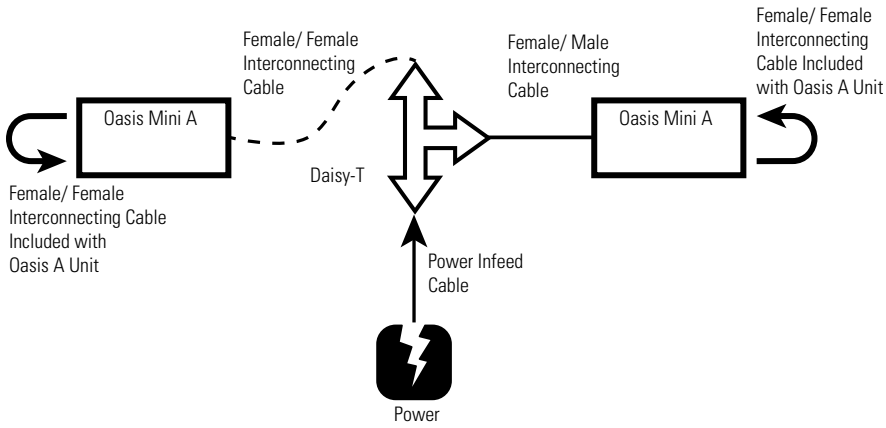

DRAWING 2B - MINI OASIS B

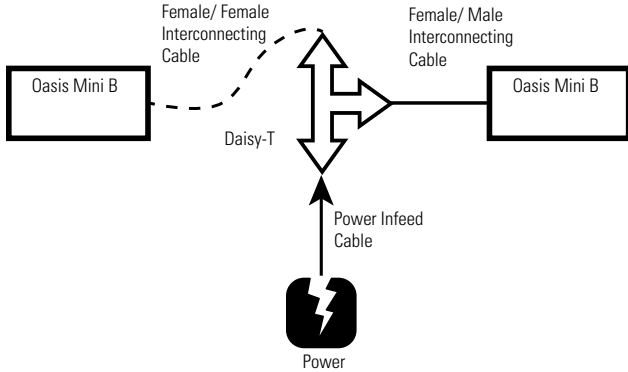

DRAWING 3 - MINI OASIS A

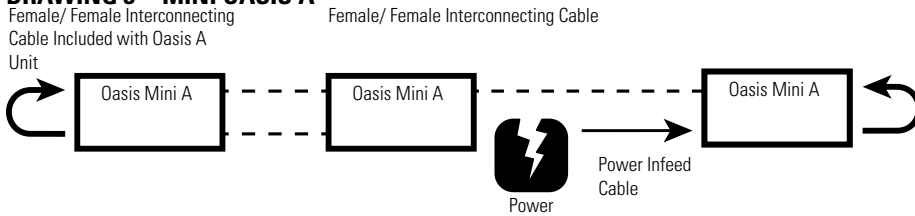

DRAWING 4 - MINI OASIS A

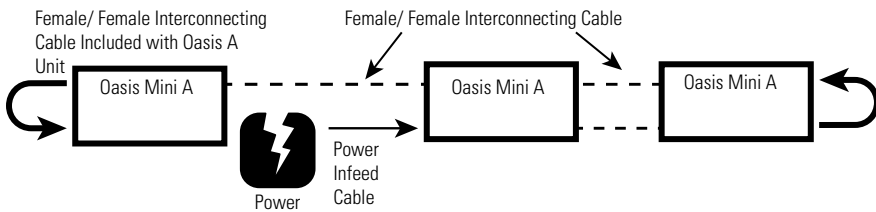

DRAWING 5 - MINI OASIS B

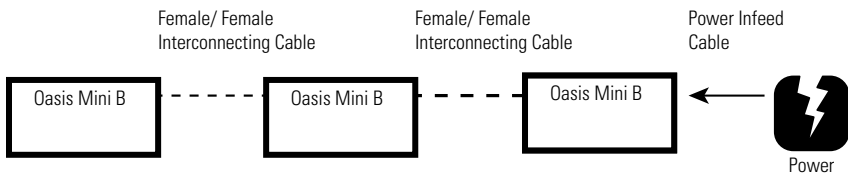

DRAWING 6 - MINI OASIS B

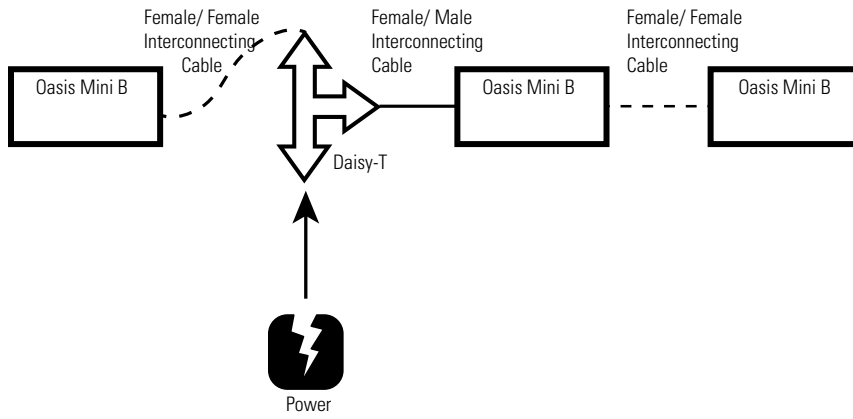

TABLE POWER + TECHNOLOGY SOLUTIONS - NOTES

OASIS MINI A & B CABLE LENGTHS NEEDED FOR DAISY-CHAINING

Model #	Oasis Mini A & Oasis Mini B	Oasis Mini A & Oasis Mini B	Oasis Mini A	Oasis Mini A	Oasis Mini B	Oasis Mini B
Cutout Positions	M1 & M3	M1 & M3	M1, M2 & M3	M1, M2 & M3	M1, M2 & M3	M1, M2 & M3
Infeed Position	Left or Right	Center	Left or Right	Center	Left or Right	Center
Reference	Drawing 1A/1B	Drawing 2A/2B	Drawing 3	Drawing 4	Drawing 5	Drawing 6
A3672RE A3672RT	N/A	N/A	N/A	N/A	N/A	N/A
A4896RE A4896B A4896RT	(1) 42FF-37 SPECIFY INFEED	(1) 42FF-21 (1) 42FM-21 (1) DAISY-T SPECIFY INFEED	N/A	N/A	N/A	N/A
A48120RE A48120RT	(1) 42FF-61 SPECIFY INFEED	(1) 42FF-32 (1) 42FM-32 (1) DAISY-T SPECIFY INFEED	(3) 42FF-29 SPECIFY INFEED	(3) 42FF-29 SPECIFY INFEED	(2) 42FF-29 SPECIFY INFEED	(2) 42FF-29 (1) 42FM-12 (1) DAISY-T SPECIFY INFEED
A48144B A48144RT	(1) 42FF-85 SPECIFY INFEED	(1) 42FF-46 (1) 42FM-46 (1) DAISY-T SPECIFY INFEED	(3) 42FF-41 SPECIFY INFEED	(3) 42FF-41 SPECIFY INFEED	(2) 41FF-42 SPECIFY INFEED	(2) 42FF-41 (1) 42FM-12 (1) DAISY-T SPECIFY INFEED
Z4896BE Z4896RTE Z4896REE Z4896BW	(1) 42FF-37 SPECIFY INFEED	(1) 42FF-21 (1) 42FM-21 (1) DAISY-T SPECIFY INFEED	N/A	N/A	N/A	N/A
Z48120BE Z48120RTE Z48120REE Z48120BW	(1) 42FF-61 SPECIFY INFEED	(1) 42FF-32 (1) 42FM-32 (1) DAISY-T SPECIFY INFEED	(3) 42FF-29 SPECIFY INFEED	(3) 42FF-29 SPECIFY INFEED	(2) 42FF-29 SPECIFY INFEED	(2) 42FF-29 (1) 42FM-12 (1) DAISY-T SPECIFY INFEED
Z48144BE Z48144RTE Z48144REE Z48144BW	(1) 42FF-85 SPECIFY INFEED	(1) 42FF-46 (1) 42FM-46 (1) DAISY-T SPECIFY INFEED	(3) 42FF-41 SPECIFY INFEED	(3) 42FF-41 SPECIFY INFEED	(2) 42FF-41 SPECIFY INFEED	(2) 42FF-41 (1) 42FM-12 (1) DAISY-T SPECIFY INFEED
Z48168BE Z48168RTE Z48168REE Z48168BW	(1) 42FF-55 (1) 42FM-55 SPECIFY INFEED	1) 42FF-58 (1) 42FM-58 (1) DAISY-T SPECIFY INFEED	(3) 42FF-52 SPECIFY INFEED	(3) 42FF-52 SPECIFY INFEED	(2) 42FF-52 SPECIFY INFEED	(2) 42FF-52 (1) 42FM-12 (1) DAISY-T SPECIFY INFEED
Z48192BE Z48192RTE Z48192REE Z48192BW	(1) 42FF-67 (1) 42FM-67 SPECIFY INFEED	1) 42FF-70 (1) 42FM-70 (1) DAISY-T SPECIFY INFEED	(3) 42FF-64 SPECIFY INFEED	(3) 42FF-64 SPECIFY INFEED	(2) 42FF-64 SPECIFY INFEED	(2) 42FF-64 (1) 42FM-12 (1) DAISY-T SPECIFY INFEED
Z48216BE Z48216RTE Z48216REE Z48216BW	(1) 42FF-79 (1) 42FM-79 SPECIFY INFEED	1) 42FF-82 (1) 42FM-82 (1) DAISY-T SPECIFY INFEED	(3) 42FF-76 SPECIFY INFEED	(3) 42FF-76 SPECIFY INFEED	(2) 42FF-76 SPECIFY INFEED	(2) 42FF-76 (1) 42FM-12 (1) DAISY-T SPECIFY INFEED
Z48240BE Z48240RTE Z48240REE Z48240BW	(1) 42FF-91 (1) 42FM-91 SPECIFY INFEED	1) 42FF-94 (1) 42FM-94 (1) DAISY-T SPECIFY INFEED	(3) 42FF-88 SPECIFY INFEED	(3) 42FF-88 SPECIFY INFEED	(2) 42FF-88 SPECIFY INFEED	(2) 42FF-88 (1) 42FM-12 (1) DAISY-T SPECIFY INFEED
Z48264BE Z48264RTE Z48264REE Z48264BW	(1) 42FF-103 (1) 42FM-103 SPECIFY INFEED	1) 42FF-106 (1) 42FM-106 (1) DAISY-T SPECIFY INFEED	(3) 42FF-100 SPECIFY INFEED	(3) 42FF-100 SPECIFY INFEED	(2) 42FF-100 SPECIFY INFEED	(2) 42FF-100 (1) 42FM-12 (1) DAISY-T SPECIFY INFEED
Z48288BE Z48288RTE Z48288REE Z48288BW	(1) 42FF-115 (1) 42FM-115 SPECIFY INFEED	1) 42FF-118 (1) 42FM-118 (1) DAISY-T SPECIFY INFEED	(3) 42FF-112 SPECIFY INFEED	(3) 42FF-112 SPECIFY INFEED	(2) 42FF-112 SPECIFY INFEED	(2) 42FF-112 (1) 42FM-12 (1) DAISY-T SPECIFY INFEED

tables and accessories



2gether

530

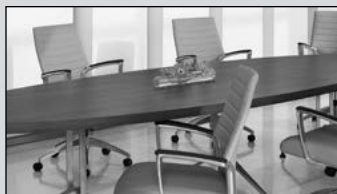

Alba

532



Boardroom

544



Bungee/Bungee SL

582



Citi Tables

638



ConnectTABLES

596



Dawson

640



Folding Tables

641



Junction

612



Nutcracker

619

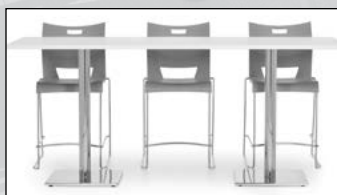

Swap Tables

627



Wind Tables

648

GENERAL INFORMATION

- Multi-purpose tables with “Easy Touch” mechanism; ideal for collaborative, training, classroom or conference environments
- “Easy Touch” mechanism allows you to flip the tables up or down with maximum ease
- Available with a fixed top or a flip-top
- Adjustable leveling casters provide smooth mobility
- The offset “Y” sculpted legs allow for parallel space-saving table nesting, to minimize footprint required for storage
- Available in two depths: 18” and 24”
- Available in three widths: 48”, 60” and 72”
- Shipped R.T.A. (Ready to Assemble)
- Global laminate and seating products are in compliance with stringent emission guidelines set out by the Greenguard Environmental Institute under the standards for low emitting products and materials. www.greenguard.org
- Level 2 Certified

CONSTRUCTION

- “Easy touch” lever located at both sides of table for flip-top operation from either side
- Tops are 1” thick, 45 lb. density particleboard with high performance thermally fused laminate surfaces
- Global’s preferred matching edge
- Tops are pre-drilled with threaded steel inserts
- Tops 60” and 72” wide feature a built-in support bar
- 14.5” high optional articulating modesty panel attaches to underside of flip-top and fixed rectangular top
- Bumpers on legs and undercarriage prevent tables from being damaged while nested
- Grommets optional on 24” deep tops only
- Champagne base finish

LAMINATE FINISHES

ACJ	Absolute Acajou	ASN	Asian Night
AWC	Avant Cherry	AWH	Avant Honey
BLK	Black	BRC	Brushed Cobalt
CSJ	Constellation Java	DES	Dark Espresso
GRY	Grey	HGT	Hayden Grey
QTM	Quartered Mahogany	SKC	Shaker Cherry
SOG	Storm Grey	TFW	Tiger Fruitwood
TMA	Tiger Mahogany	TMP	Tiger Maple
TWL	Tiger Walnut	WHT	White
WHC	White Chocolate*	WGY	Willow Grey
WCR	Winter Cherry		*textured

GROMMETS

- Available only on 24” deep worksurfaces
- Additional grommets available in standard worksurface locations (left, center or right). Order as: **AG1, AG2 or AG3.....Add \$65**
- Grommet hole dimensions are 3 ¼” wide x 1 7/8” deep.

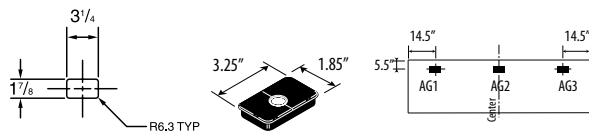

- Grommets may be placed at non-standard locations. Order as: **AGS - ADD \$65.00** A drawing must be supplied with vertical and horizontal dimensions to the center of the cut-out (as in drawing above). Please refer to CUSTOM GROMMET LOCATION FORM in the back reference section.

POWER BLOCK

- Available only on 24” deep worksurfaces
- A Power Block is a rectangular worksurface power/data module with one electrical duplex receptacle and two data (RJ45) receptacles. 9’ black cord included. Power Block dimensions are 3 ½” deep x 6 ½” wide x 2 ¾” high.
- A Power Block (model **PMSPDM**) may be ordered for **24” Deep Tables** in place of standard grommets.
- To purchase a Power Block, you must specify both the Power Block cut-out location and the Power Block model #. Order Power Block as **PMSPDM, ADD \$238**. Power Blocks are available in standard worksurface locations (left, center or right). Order as **E1, E2 or E3. ADD \$65.00**.

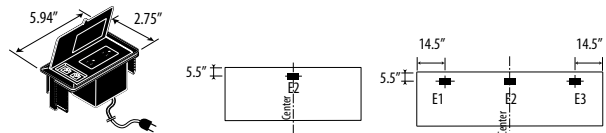

For 48”w units

For 60” and 72”w units.

Power Block **PMSPDM, Add \$238** Specify location **E1, E2 or E3, Add \$65**

VILLA CUTOUTS

- Available only on 24” deep worksurfaces
- A Villa Power Block is available in kits for daisy-chaining, or corded for use on individual tables (see page 520 for Villa details). Villa Power Block dimensions vary by model. Villa cutout dimensions are 3” deep x 5 ¼” wide
- A Villa cutout may be ordered for 24” Deep Tables. Order as **V1, V2 or V3, Add \$65 for each cutout**.
- Order Villa Power Block and Villa Grommet Cover separately, see page 520 for pricing and details
- **Villa is only available on Zgether, Bungee, Junction, Connectables and Zira Boardroom tables**

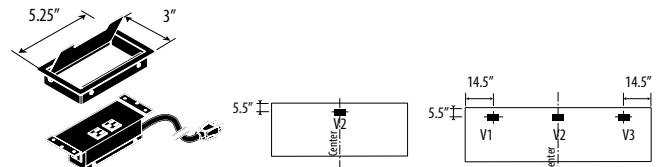

For 48”w units

For 60” and 72”w units.

SHIPPING

- Items are shipped R.T.A. (Ready To Assemble)
- Easy to assemble with screwdriver
- Each top is packaged and shipped individually
- “Y” legs are packaged and shipped in one carton
- Table base is packaged and shipped in one carton

RECTANGULAR TOP **MODEL#** **DIMENSIONS** **FREIGHT CLASS** **WT/LBS.** **CUBIC FT.** **LIST PRICE** **HP ADD**

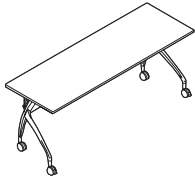

Rectangular Table - Fixed Top

	D x W x H						
IT2472R	24 x 72 x 29	85	88.50	6.77	\$1398	\$194	
IT2460R	24 x 60 x 29	85	77.80	5.99	\$1300	\$172	
IT2448R	24 x 48 x 29	85	67.40	5.09	\$1169	\$143	
IT1872R	18 x 72 x 29	85	75.50	6.08	\$1341	\$181	
IT1860R	18 x 60 x 29	85	66.80	5.27	\$1248	\$151	
IT1848R	18 x 48 x 29	85	58.40	4.49	\$1130	\$126	

Freestanding fixed top table with offset Y leg on 4 adjustable leveling casters, 2 locking. Wire management channel included. Champagne finish leg, black casters. Optional articulating modesty panel available.

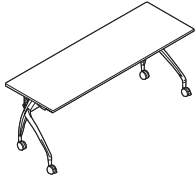

Rectangular Table - Flip-Top

IT2472RX	24 x 72 x 29	92.5	97.20	8.68	\$1499	\$194	
IT2460RX	24 x 60 x 29	92.5	86	7.68	\$1401	\$172	
IT2448RX	24 x 48 x 29	92.5	74.70	6.47	\$1270	\$143	
IT1872RX	18 x 72 x 29	92.5	84.20	7.98	\$1443	\$181	
IT1860RX	18 x 60 x 29	92.5	75	6.98	\$1349	\$151	
IT1848RX	18 x 48 x 29	92.5	65.70	5.88	\$1231	\$126	

Easy touch flip-top table on 4 adjustable leveling casters, 2 locking. Easy touch lever located at both ends of the table allows for activation on either side of the table; offset Y leg accommodates in-line nesting for space-saving storage. Wire management channel included. Champagne finish leg, black casters. Optional articulating modesty panel available.

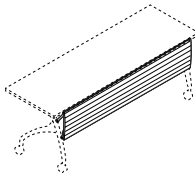

Modesty Panel

IT72MP	14.25 x 63 x 2.75	125	13.20	2	\$217		
IT60MP	14.25 x 51 x 2.75	125	11.40	1.60	\$200		
IT48MP	14.25 x 39 x 2.75	125	9.70	1.30	\$183		

Articulating modesty for use with flip-top or fixed top 2gether tables. Champagne finish.

Required Specifications
Top Finish

Accessories
Modesty Panel



Contemporary and stylish meeting tables with unique METAL bases. Offers a variety of options to suit the needs of any office.

Tops are available in your choice of six shapes - Round, Square, Rectangular, Boat Shaped, Racetrack and Elliptical.

Two different metal base styles - Sculpted and Four-Legged. Round and Square tops are available exclusively with the four-legged base, while all other tops are available in Sculpted base style.

Five edge options - Self, Bullnose, T-Mold, Built Up and the Slant edge. Slant Edge and Metal Base finishes are available in either Black or Tungsten.

No matter the size of the space or the style of the office, Global's Laminate Meeting tables will work in any setting.

Designed exclusively for Global by world renowned designer Zooey Chu.



Features and Benefits

- Tables 144" or less are standard in one piece
- All tops over 144" are standard in two pieces
- One-piece tops can be cut to 2 pieces for an upcharge
- All tops and bases are assembled using a metal-to-metal connection
- All tops are 1 1/8" thick - a 1 3/4" built-up self edge is available on all models
- Tops and bases boxed as appropriate
- Custom finish laminate tables available as special order
- Bullnose edge available in Black or Grey
- T-Mold edge available in Black, Grey or coordinating laminate finish.
- Self-edge and built-up self edge available in same color as laminate finish.
- Slant edge is available in Black or Tungsten
- All edges available on all tables
- All Metal bases are available in Black and Tungsten

GENERAL INFORMATION

- Designed by Zooney Chu
- Five edge options: Self, Bullnose, T-Mold, Built-Up and Slant edge.
- Two different metal base styles - Sculpted and Four-Legged
- Global laminate and seating products are in compliance with stringent emission guidelines set out by the Greenguard Environmental Institute under the standards for low emitting products and materials. www.greenguard.org
- **Level 2 Certified**

CONSTRUCTION

- All Laminate Meeting tables are 29" high and made of 45 lb. density particle board covered on both sides with high performance, thermally fused laminate. Table width is nominal.
- All tops are 1 1/8" thick with high performance, thermally fused laminate on both sides. A 1 3/4" built-up self edge is available on all models.
- Tops are crated and bases boxed or crated as appropriate
- Table tops of 144" or less in length are standard as one piece. One piece tops can be cut to 2 piece tops, **ADD \$204.00**.
- All Tops and Bases use a metal to metal connection, allowing for easy installation.
- Custom size tables are priced at next size table price, not to exceed width or length. Example: 44" x 108" would be priced at the 48" x 120" price. Contact Customer Service for pricing of tables over 48" in width. Custom tables less than the smallest size must be quoted.

EDGE OPTIONS

- Self, built-up, bullnose, T-mold and slant edges are available on all models. Corners of rectangular, square and boat shaped tables ordered with T-mold or bullnose will be rounded.
- **Bullnose** edge is available in Black (**BK**) or Grey (**GR**) only.
- **T-mold** edge is available in Black (**BK**), Grey (**GR**), or coordinating laminate finish (**ME**)
- **Slant** edge is available in Black (**BLK**) or Tungsten (**TUN**).
- **Self edge and built-up** edges are same color as laminate finish.

LAMINATE FINISHES

ACJ	Absolute Acajou	ASN	Asian Night
AWC	Avant Cherry	AWH	Avant Honey
BLK	Black	BRC	Brushed Cobalt
CSJ	Constellation Java	DES	Dark Espresso
GRY	Grey	HGT	Hayden Grey
QTM	Quartered Mahogany	SKC	Shaker Cherry
SOG	Storm Grey	TFW	Tiger Fruitwood
TMA	Tiger Mahogany	TMP	Tiger Maple
TWL	Tiger Walnut	WHT	White
WHC	White Chocolate*	WGY	Willow Grey
WCR	Winter Cherry		<i>*textured</i>

- White Chocolate (**WHC**) not available on 10 & 12 foot tables. Must be cut in two pieces and specify third base.
- The above laminate finishes are available in **High Pressure**. Upcharge varies by model.
- Tables in woodgrain finishes over 12' in length will not have a perfect match of grain at the center where the two halves meet.
- If other than a Global standard laminate finish is preferred, contact Customer Care. Information needed includes the name of the laminate manufacturer, color name, number and model of table. You will then be given a quote for this special order.

BASE SIZE CHART (Table width is nominal)

Round or Square Tops		Rectangular, Racetrack, Boat or Elliptical Tops	
Top	4 Leg	Top	Sculpted
30"	25"	30" x 60"	24"
36"	25"	44" x 84"	30"
42"	32"	36" x 72"	24"
48"	32"	48" x 96"	30"
		48" x 120"	30"
		48" x 144"	30"

SCULPTED BASE

- Sculpted bases on tables 7' and larger include support braces for maximum strength. Not included on 5' and 6' tables. Bases are available in Black (**BLK**) or Tungsten (**TUN**) finish only.



GROMMETS

- Grommets available in standard table top locations (left, center or right). Order as: **AG1, AG2 or AG3.....Add \$65**
- Grommet hole dimensions are 3 1/4" wide x 1 7/8" deep.

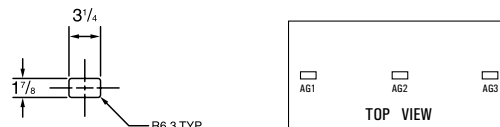

- Actual grommet locations will vary according to base selection.

POWER BLOCK

- A Power Block (model **PMSPPM**) may be ordered on all worksurfaces.
- A Power Block is a rectangular worksurface power/data module with one electrical duplex receptacle and two data (RJ45) receptacles. 9' black cord included. Power Block dimensions are 3 1/2" deep x 6 1/2" wide x 2 3/4" high.
- Actual Power Block locations vary according to base selection. The locations will be left (AG1, E1), center (AG2, E2), and right (AG3, E3). **Example:** 8' table with drum base does not have a modesty panel, so the grommet (AG2) and power block (E2) can be perfectly centered in the table. An 8' table with a slab base has the modesty panel, so the grommet (AG2) and power block (E2) will be offset alongside the modesty panel.
- To purchase a Power Block, you must specify both the Power Block cut-out location and the Power Block model #. Order Power Block as **PMSPPM, ADD \$238**. Power Blocks are available in standard worksurface locations (left, center or right). Order as **E1, E2 or E3. ADD \$65.00**.



Power Block **PMSPPM, Add \$238** Specify location **E1, E2 or E3, Add \$65**

- Use the following for determining the size of a round table and the number of chairs needed for a conference area. All estimates are based on an average chair width of 23" with a 4" clearance between chairs. Adjust accordingly for a different chair size.

Top Size	Round	Square	Rectangular	Boat	Racetrack	Elliptical
30x30	3	3	N/A	N/A	N/A	N/A
36x36	4	4	N/A	N/A	N/A	N/A
42x42	4	4	N/A	N/A	N/A	N/A
48x48	4	4	N/A	N/A	N/A	N/A
60x60	5	6	N/A	N/A	N/A	N/A
30x60	N/A	N/A	4-6	4-6	4-6	4
36x72	N/A	N/A	4-6	4-6	4-6	4
44x84	N/A	N/A	6-8	6-8	6-8	6
48x96	N/A	N/A	6-8	6-8	6-8	6
48x120	N/A	N/A	8-10	8-10	8-10	8
48x144	N/A	N/A	10-12	10-12	10-12	10
48x168	N/A	N/A	12-14	12-14	12-14	12
48x192	N/A	N/A	14-16	14-16	14-16	14
48x216	N/A	N/A	16-18	16-18	16-18	16
48x240	N/A	N/A	18-20	18-20	18-20	18
48x264	N/A	N/A	20-22	20-22	20-22	20
48x288	N/A	N/A	22-24	22-24	22-24	22

ROUND TOP - FOUR LEGGED BASE

	MODEL#	DIMENSIONS	FREIGHT CLASS	WT/LBS.	CUBIC FT.	LIST PRICE	HP ADD
D x W x H							
self edge	GC30CF	0 x 30 x 29	125	54.50	7.06	\$525	\$262
bullnose edge	GC30CFBN	0 x 30 x 29	125	54.50	7.06	\$525	\$262
T-mold edge	GC30CFM	0 x 30 x 29	125	54.50	7.06	\$525	\$262
built-up self edge	GC30CFBU	0 x 30 x 29	125	59.50	7.82	\$610	\$305
slant edge	GC30CFZS	0 x 30 x 29	125	54.50	7.06	\$525	\$262
self edge	GC36CF	0 x 36 x 29	100	72.50	7.50	\$569	\$284
bullnose edge	GC36CFBN	0 x 36 x 29	100	72.50	7.50	\$569	\$284
T-mold edge	GC36CFM	0 x 36 x 29	100	72.50	7.50	\$569	\$284
built-up self edge	GC36CFBU	0 x 36 x 29	100	79.50	8.44	\$653	\$326
slant edge	GC36CFZS	0 x 36 x 29	100	72.50	7.50	\$569	\$284
self edge	GC42CF	0 x 42 x 29	125	83.29	11.12	\$669	\$334
bullnose edge	GC42CFBN	0 x 42 x 29	125	83.29	11.12	\$669	\$334
T-mold edge	GC42CFM	0 x 42 x 29	125	83.29	11.12	\$669	\$334
built-up self edge	GC42CFBU	0 x 42 x 29	125	92.10	12.40	\$754	\$377
slant edge	GC42CFZS	0 x 42 x 29	125	83.29	11.12	\$669	\$334
self edge	GC48CF	0 x 48 x 29	100	98.29	11.72	\$753	\$376
bullnose edge	GC48CFBN	0 x 48 x 29	100	98.29	11.72	\$753	\$376
T-mold edge	GC48CFM	0 x 48 x 29	100	98.29	11.72	\$753	\$376
built-up self edge	GC48CFBU	0 x 48 x 29	100	109	13.38	\$838	\$419
slant edge	GC48CFZS	0 x 48 x 29	100	98.29	11.72	\$753	\$376

SQUARE TOP - FOUR LEGGED BASE

self edge	GC30SF	30 x 30 x 29	125	54.50	7.06	\$525	\$262
bullnose edge	GC30SFBN	30 x 30 x 29	125	54.50	7.06	\$525	\$262
T-mold edge	GC30SFM	30 x 30 x 29	125	54.50	7.06	\$525	\$262
built-up self edge	GC30SFBU	30 x 30 x 29	125	59.50	7.82	\$610	\$305
slant edge	GC30SFZS	30 x 30 x 29	125	54.50	7.06	\$525	\$262
self edge	GC36SF	36 x 36 x 29	100	72.50	7.50	\$569	\$284
bullnose edge	GC36SFBN	36 x 36 x 29	100	72.50	7.50	\$569	\$284
T-mold edge	GC36SFM	36 x 36 x 29	100	72.50	7.50	\$569	\$284
built-up self edge	GC36SFBU	36 x 36 x 29	100	79.50	8.44	\$653	\$326
slant edge	GC36SFZS	36 x 36 x 29	100	72.50	7.50	\$569	\$284
self edge	GC42SF	42 x 42 x 29	125	83.29	11.12	\$669	\$334
bullnose edge	GC42SFBN	42 x 42 x 29	125	83.29	11.12	\$669	\$334
T-mold edge	GC42SFM	42 x 42 x 29	125	83.29	11.12	\$669	\$334
built-up self edge	GC42SFBU	42 x 42 x 29	125	92.10	12.40	\$754	\$377
slant edge	GC42SFZS	42 x 42 x 29	125	83.29	11.12	\$669	\$334
self edge	GC48SF	48 x 48 x 29	100	98.29	11.72	\$753	\$376
bullnose edge	GC48SFBN	48 x 48 x 29	100	98.29	11.72	\$753	\$376
T-mold edge	GC48SFM	48 x 48 x 29	100	98.29	11.72	\$753	\$376
built-up self edge	GC48SFBU	48 x 48 x 29	100	109	13.38	\$838	\$419
slant edge	GC48SFZS	48 x 48 x 29	100	98.29	11.72	\$753	\$376

Required Specifications

Finish
Base Finish
Edge Color, if applicable

A ALBA™ TABLES

RECTANGULAR TOP - SCULPTED BASE

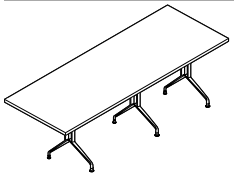

5 foot

	MODEL#	DIMENSIONS	FREIGHT CLASS	WT/LBS.	CUBIC FT.	LIST PRICE	HP ADD
D x W x H							
self edge	GR5S	30 x 60 x 29	150	91.40	17.96	\$893	\$446
bullnose edge	GR5SBN	30 x 60 x 29	150	91.40	17.96	\$893	\$446
T-mold edge	GR5STM	30 x 60 x 29	150	91.40	17.96	\$893	\$446
built-up self edge	GR5SBU	30 x 60 x 29	150	91.40	17.96	\$1034	\$517
slant edge	GR5SZS	30 x 60 x 29	150	91.40	17.96	\$893	\$446

• ships in one piece

6 foot

self edge	GR6S	36 x 72 x 29	150	109.40	22.40	\$978	\$489
bullnose edge	GR6SBN	36 x 72 x 29	150	109.40	22.40	\$978	\$489
T-mold edge	GR6STM	36 x 72 x 29	150	109.40	22.40	\$978	\$489
built-up self edge	GR6SBU	36 x 72 x 29	150	118.40	22.40	\$1117	\$558
slant edge	GR6SZS	36 x 72 x 29	150	109.40	22.40	\$978	\$489

• ships in one piece

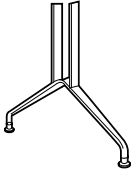

Sculpted Base

7 foot

self edge	GR7S	44 x 84 x 29	250	103.04	33.77	\$1120	\$560
bullnose edge	GR7SBN	44 x 84 x 29	250	103.04	33.77	\$1120	\$560
T-mold edge	GR7STM	44 x 84 x 29	250	103.04	33.77	\$1120	\$560
built-up self edge	GR7SBU	44 x 84 x 29	250	115.29	33.77	\$1260	\$630
slant edge	GR7SZS	44 x 84 x 29	250	103.04	33.77	\$1120	\$560

• ships in one piece

8 foot

self edge	GR8WS	48 x 96 x 29	250	149.40	38.29	\$1120	GC
bullnose edge	GR8WSBN	48 x 96 x 29	250	149.40	38.29	\$1120	GC
T-mold edge	GR8WSTM	48 x 96 x 29	250	149.40	38.29	\$1120	GC
built-up self edge	GR8WSBU	48 x 96 x 29	150	165.40	38.29	\$1260	GC
slant edge	GR8WSZS	48 x 96 x 29	250	149.40	38.29	\$1120	GC

• ships in one piece

10 foot

self edge	GR10WS	48 x 120 x 29	70	256.10	15.80	\$1567	\$783
bullnose edge	GR10WSBN	48 x 120 x 29	70	256.10	15.80	\$1567	\$783
T-mold edge	GR10WSTM	48 x 120 x 29	70	256.10	15.80	\$1567	\$783
built-up self edge	GR10WSBU	48 x 120 x 29	70	276.10	15.80	\$1708	\$854
slant edge	GR10WSZS	48 x 120 x 29	70	256.10	15.80	\$1567	\$783

• ships in one piece

12 foot

self edge	GR12WS	48 x 144 x 29	85	281.10	18.80	\$1736	\$868
bullnose edge	GR12WSBN	48 x 144 x 29	85	281.10	18.80	\$1736	\$868
T-mold edge	GR12WSTM	48 x 144 x 29	85	281.10	18.80	\$1736	\$868
built-up self edge	GR12WSBU	48 x 144 x 29	70	305.10	18.80	\$1875	\$937
slant edge	GR12WSZS	48 x 144 x 29	85	281.10	18.80	\$1736	\$868

• ships in one piece

14 foot

self edge	GR14WS	48 x 168 x 29	100	164.25	20.05	\$2343	\$1171
bullnose edge	GR14WSBN	48 x 168 x 29	100	164.25	20.05	\$2343	\$1171
T-mold edge	GR14WSTM	48 x 168 x 29	100	164.25	20.05	\$2343	\$1171
built-up self edge	GR14WSBU	48 x 168 x 29	100	188.30	20.05	\$2540	\$1270
slant edge	GR14WSZS	48 x 168 x 29	100	164.25	20.05	\$2343	\$1171

• ships in two pieces

16 foot

self edge	GR16WS	48 x 192 x 29	92.5	257.18	23.05	\$2343	\$1171
bullnose edge	GR16WSBN	48 x 192 x 29	92.5	257.18	23.05	\$2343	\$1171
T-mold edge	GR16WSTM	48 x 192 x 29	92.5	257.18	23.05	\$2343	\$1171
built-up self edge	GR16WSBU	48 x 192 x 29	85	285.20	23.05	\$2540	\$1270
slant edge	GR16WSZS	48 x 192 x 29	92.5	257.18	23.05	\$2343	\$1171

• ships in two pieces

Required Specifications

Finish
Base Finish
Edge Color, if applicable

Optional Specifications

Grommet

Accessories

Power Block

RECTANGULAR TOP - SCULPTED BASE

		MODEL#	DIMENSIONS	FREIGHT CLASS	WT/LBS.	CUBIC FT.	LIST PRICE	HP ADD
		D x W x H						
18 foot	self edge	GR18WS	48 x 216 x 29	85	390	26.10	\$2829	\$1414
	bullnose edge	GR18WSBN	48 x 216 x 29	85	390	26.10	\$2829	\$1414
	T-mold edge	GR18WSTM	48 x 216 x 29	85	390	26.10	\$2829	\$1414
	built-up self edge	GR18WSBU	48 x 216 x 29	85	390	26.10	\$3026	\$1513
	slant edge	GR18WSZS	48 x 216 x 29	85	390	26.10	\$2829	\$1414
	• ships in two pieces							
20 foot	self edge	GR20WS	48 x 240 x 29	250	492.20	189.2	\$3221	\$1610
	bullnose edge	GR20WSBN	48 x 240 x 29	250	492.20	189.2	\$3221	\$1610
	T-mold edge	GR20WSTM	48 x 240 x 29	250	492.20	189.2	\$3221	\$1610
	built-up self edge	GR20WSBU	48 x 240 x 29	250	532.20	189.2	\$3418	\$1709
	slant edge	GR20WSZS	48 x 240 x 29	250	492.20	189.2	\$3221	\$1610
	• ships in two pieces							
22 foot	self edge	GR22WS	48 x 264 x 29	250	509.50	204.3	\$3613	\$1806
	bullnose edge	GR22WSBN	48 x 264 x 29	250	509.50	204.3	\$3613	\$1806
	T-mold edge	GR22WSTM	48 x 264 x 29	250	509.50	204.3	\$3613	\$1806
	built-up self edge	GR22WSBU	48 x 264 x 29	250	553.50	204.3	\$3808	\$1904
	slant edge	GR22WSZS	48 x 264 x 29	250	509.50	204.3	\$3613	\$1806
	• ships in two pieces							
24 foot	self edge	GR24WS	48 x 288 x 29	250	542.20	225.2	\$4015	\$2007
	bullnose edge	GR24WSBN	48 x 288 x 29	250	542.20	225.2	\$4015	\$2007
	T-mold edge	GR24WSTM	48 x 288 x 29	250	542.20	225.2	\$4015	\$2007
	built-up self edge	GR24WSBU	48 x 288 x 29	250	590.20	225.2	\$4211	\$2105
	slant edge	GR24WSZS	48 x 288 x 29	250	542.20	225.2	\$4015	\$2007
	• ships in two pieces							

- All tops over 144" are standard in two pieces. Woodgrain laminate finishes will NOT align where the two tops join.
- All tops 120", 144", 168" and 192" are SHIPPED WITH 3 SCULPTED BASES.
- All tops 216" and 240" are SHIPPED WITH 4 SCULPTED BASES.
- All tops 264" and 288" are SHIPPED WITH 5 SCULPTED BASES.

Required Specifications

Finish
Base Finish
Edge Color, if applicable

Optional Specifications



Grommet

Accessories

Power Block

A ALBA™ TABLES

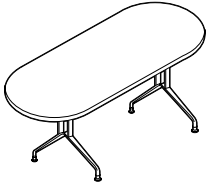
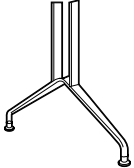
RACETRACK TOP - SCULPTED BASE

		MODEL#	DIMENSIONS	FREIGHT CLASS	WT/LBS.	CUBIC FT.	LIST PRICE	HP ADD	
		D x W x H							
	5 foot	self edge	GRT5S	30 x 60 x 29	150	91.40	17.96	\$893	\$446
		bullnose edge	GRT5SBN	30 x 60 x 29	150	91.40	17.96	\$893	\$446
		T-mold edge	GRT5STM	30 x 60 x 29	150	91.40	17.96	\$893	\$446
		built-up self edge	GRT5SBU	30 x 60 x 29	250	91.40	24	\$1034	\$517
		slant edge	GRT5SZS	30 x 60 x 29	150	91.40	17.96	\$893	\$446
		• ships in one piece							
	6 foot	self edge	GRT6S	36 x 72 x 29	150	99.40	22.40	\$978	\$489
		bullnose edge	GRT6SBN	36 x 72 x 29	150	99.40	22.40	\$978	\$489
		T-mold edge	GRT6STM	36 x 72 x 29	150	99.40	22.40	\$978	\$489
		built-up self edge	GRT6SBU	36 x 72 x 29	150	108.40	22.40	\$1117	\$558
		slant edge	GRT6SZS	36 x 72 x 29	150	99.40	22.40	\$978	\$489
		• ships in one piece							
	7 foot	self edge	GRT7S	44 x 84 x 29	250	93.40	33.77	\$1120	\$560
		bullnose edge	GRT7SBN	44 x 84 x 29	250	93.40	33.77	\$1120	\$560
		T-mold edge	GRT7STM	44 x 84 x 29	250	93.40	33.77	\$1120	\$560
		built-up self edge	GRT7SBU	44 x 84 x 29	250	116.65	33.77	\$1260	\$630
		slant edge	GRT7SZS	44 x 84 x 29	250	93.40	33.77	\$1120	\$560
		• ships in one piece							
	8 foot	self edge	GRT8WS	48 x 96 x 29	250	139.40	38.29	\$1120	GR
		bullnose edge	GRT8WSBN	48 x 96 x 29	250	139.40	38.29	\$1120	GR
		T-mold edge	GRT8WSTM	48 x 96 x 29	250	139.40	38.29	\$1120	GR
		built-up self edge	GRT8WSBU	48 x 96 x 29	250	151.40	38.29	\$1260	GR
		slant edge	GRT8WSZS	48 x 96 x 29	250	139.40	38.29	\$1120	GR
		• ships in one piece							
	10 foot	self edge	GRT10WS	48 x 120 x 29	70	246.10	15.80	\$1567	\$783
		bullnose edge	GRT10WSBN	48 x 120 x 29	70	246.10	15.80	\$1567	\$783
		T-mold edge	GRT10WSTM	48 x 120 x 29	70	246.10	15.80	\$1567	\$783
		built-up self edge	GRT10WSBU	48 x 120 x 29	70	266.10	15.80	\$1708	\$854
		slant edge	GRT10WSZS	48 x 120 x 29	70	246.10	15.80	\$1567	\$783
		• ships in one piece							
	12 foot	self edge	GRT12WS	48 x 144 x 29	85	271.10	18.80	\$1736	\$868
		bullnose edge	GRT12WSBN	48 x 144 x 29	85	271.10	18.80	\$1736	\$868
		T-mold edge	GRT12WSTM	48 x 144 x 29	85	271.10	18.80	\$1736	\$868
		built-up self edge	GRT12WSBU	48 x 144 x 29	70	295.10	18.80	\$1875	\$937
		slant edge	GRT12WSZS	48 x 144 x 29	85	271.10	18.80	\$1736	\$868
		• ships in one piece							
	14 foot	self edge	GRT14WS	48 x 168 x 29	100	164.25	20.05	\$2343	\$1171
		bullnose edge	GRT14WSBN	48 x 168 x 29	100	164.25	20.05	\$2343	\$1171
		T-mold edge	GRT14WSTM	48 x 168 x 29	100	164.25	20.05	\$2343	\$1171
		built-up self edge	GRT14WSBU	48 x 168 x 29	100	192.30	20.05	\$2540	\$1270
		slant edge	GRT14WSZS	48 x 168 x 29	100	164.25	20.05	\$2343	\$1171
		• ships in two pieces							
	16 foot	self edge	GRT16WS	48 x 192 x 29	92.5	257.18	23.05	\$2343	\$1171
		bullnose edge	GRT16WSBN	48 x 192 x 29	92.5	257.18	23.05	\$2343	\$1171
		T-mold edge	GRT16WSTM	48 x 192 x 29	92.5	257.18	23.05	\$2343	\$1171
		built-up self edge	GRT16WSBU	48 x 192 x 29	85	289.20	23.05	\$2540	\$1270
		slant edge	GRT16WSZS	48 x 192 x 29	92.5	257.18	23.05	\$2343	\$1171
		• ships in two pieces							

Sculpted Base

Required Specifications

Finish
Base Finish
Edge Color, if applicable

Optional Specifications

Grommet

Accessories

Power Block

RACETRACK TOP - SCULPTED BASE

	MODEL#	DIMENSIONS	FREIGHT CLASS	WT/LBS.	CUBIC FT.	LIST PRICE	HP ADD
D x W x H							
18 foot	self edge	GRT18WS	48 x 216 x 29	85	390	26.10	\$2829 \$1414
	bullnose edge	GRT18WSBN	48 x 216 x 29	85	390	26.10	\$2829 \$1414
	T-mold edge	GRT18WSTM	48 x 216 x 29	85	390	26.10	\$2829 \$1414
	built-up self edge	GRT18WSBU	48 x 216 x 29	70	426	26.10	\$3026 \$1513
	slant edge	GRT18WSZS	48 x 216 x 29	85	390	26.10	\$2829 \$1414
	• ships in two pieces						
20 foot	self edge	GRT20WS	48 x 240 x 29	250	492.20	189.2	\$3221 \$1610
	bullnose edge	GRT20WSBN	48 x 240 x 29	250	492.20	189.2	\$3221 \$1610
	T-mold edge	GRT20WSTM	48 x 240 x 29	250	492.20	189.2	\$3221 \$1610
	built-up self edge	GRT20WSBU	48 x 240 x 29	250	532.20	189.2	\$3418 \$1709
	slant edge	GRT20WSZS	48 x 240 x 29	250	492.20	189.2	\$3221 \$1610
	• ships in two pieces						
22 foot	self edge	GRT22WS	48 x 264 x 29	250	509.50	204.3	\$3613 \$1806
	bullnose edge	GRT22WSBN	48 x 264 x 29	250	509.50	204.3	\$3613 \$1806
	T-mold edge	GRT22WSTM	48 x 264 x 29	250	509.50	204.3	\$3613 \$1806
	built-up self edge	GRT22WSBU	48 x 264 x 29	250	553.50	204.3	\$3808 \$1904
	slant edge	GRT22WSZS	48 x 264 x 29	250	509.50	204.3	\$3613 \$1806
	• ships in two pieces						
24 foot	self edge	GRT24WS	48 x 288 x 29	250	542.20	225.2	\$4015 \$2007
	bullnose edge	GRT24WSBN	48 x 288 x 29	250	542.20	225.2	\$4015 \$2007
	T-mold edge	GRT24WSTM	48 x 288 x 29	250	542.20	225.2	\$4015 \$2007
	built-up self edge	GRT24WSBU	48 x 288 x 29	250	590.20	225.2	\$4211 \$2105
	slant edge	GRT24WSZS	48 x 288 x 29	250	542.20	225.2	\$4015 \$2007
	• ships in two pieces						

- All tops over 144" are standard in two pieces. Woodgrain laminate finishes will NOT align where the two tops join.
- All tops 120", 144", 168" and 192" are SHIPPED WITH 3 SCULPTED BASES.
- All tops 216" and 240" are SHIPPED WITH 4 SCULPTED BASES.
- All tops 264" and 288" are SHIPPED WITH 5 SCULPTED BASES.

Required Specifications

Finish
Base Finish
Edge Color, if applicable

Optional Specifications

Grommet

Accessories

Power Block

A ALBA™ TABLES

BOAT TOP - SCULPTED BASE

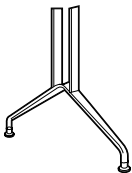
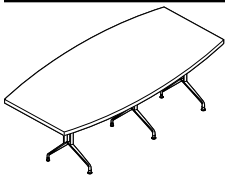

Sculpted Base

		MODEL#	DIMENSIONS	FREIGHT CLASS	WT/LBS.	CUBIC FT.	LIST PRICE	HP ADD
		D x W x H						
5 foot	self edge	GB5S	30 x 60 x 29	150	91.40	17.96	\$893	\$446
	bullnose edge	GB5SBN	30 x 60 x 29	150	91.40	17.96	\$893	\$446
	T-mold edge	GB5STM	30 x 60 x 29	150	91.40	17.96	\$893	\$446
	built-up self edge	GB5SBU	30 x 60 x 29	150	91.40	17.96	\$1034	\$517
	slant edge	GB5SZS	30 x 60 x 29	150	91.40	17.96	\$893	\$446
	• ships in one piece							
6 foot	self edge	GB6S	36 x 72 x 29	300	99.40	58.08	\$995	\$497
	bullnose edge	GB6SBN	36 x 72 x 29	300	99.40	58.08	\$995	\$497
	T-mold edge	GB6STM	36 x 72 x 29	300	99.40	58.08	\$995	\$497
	built-up self edge	GB6SBU	36 x 72 x 29	300	106.50	58.08	\$1134	\$567
	slant edge	GB6SZS	36 x 72 x 29	300	99.40	58.08	\$995	\$497
	• ships in one piece							
7 foot	self edge	GB7S	44 x 84 x 29	250	93.40	33.77	\$1120	\$560
	bullnose edge	GB7SBN	44 x 84 x 29	250	93.40	33.77	\$1120	\$560
	T-mold edge	GB7STM	44 x 84 x 29	250	93.40	33.77	\$1120	\$560
	built-up self edge	GB7SBU	44 x 84 x 29	250	123.70	33.77	\$1260	\$630
	slant edge	GB7SZS	44 x 84 x 29	250	93.40	33.77	\$1120	\$560
	• ships in one piece							
8 foot	self edge	GB8WS	48 x 96 x 29	300	139.40	92.51	\$1198	\$599
	bullnose edge	GB8WSBN	48 x 96 x 29	300	139.40	92.51	\$1136	\$568
	T-mold edge	GB8WSTM	48 x 96 x 29	300	139.40	92.51	\$1136	\$568
	built-up self edge	GB8WSBU	48 x 96 x 29	300	151.40	92.51	\$1276	\$638
	slant edge	GB8WSZS	48 x 96 x 29	300	139.40	92.51	\$1136	\$568
	• ships in one piece							
10 foot	self edge	GB10WS	48 x 120 x 29	250	246.10	101.5	\$1584	\$792
	bullnose edge	GB10WSBN	48 x 120 x 29	250	246.10	101.5	\$1584	\$792
	T-mold edge	GB10WSTM	48 x 120 x 29	125	246.10	33.88	\$1584	\$792
	built-up self edge	GB10WSBU	48 x 120 x 29	125	266.10	33.88	\$1723	\$861
	slant edge	GB10WSZS	48 x 120 x 29	125	246.10	33.88	\$1584	\$792
	• ships in one piece							
12 foot	self edge	GB12WS	48 x 144 x 29	250	271.10	110.4	\$1750	\$875
	bullnose edge	GB12WSBN	48 x 144 x 29	250	271.10	110.4	\$1750	\$875
	T-mold edge	GB12WSTM	48 x 120 x 29	125	271.10	36.88	\$1750	\$875
	built-up self edge	GB12WSBU	48 x 144 x 29	100	295.10	36.88	\$1891	\$945
	slant edge	GB12WSZS	48 x 144 x 29	125	271.10	36.88	\$1750	\$875
	• ships in one piece							
14 foot	self edge	GB14WS	48 x 168 x 29	100	164.25	20.05	\$2343	\$1171
	bullnose edge	GB14WSBN	48 x 168 x 29	100	164.25	20.05	\$2343	\$1171
	T-mold edge	GB14WSTM	48 x 168 x 29	100	164.25	20.05	\$2343	\$1171
	built-up self edge	GB14WSBU	48 x 168 x 29	100	192.30	20.05	\$2540	\$1270
	slant edge	GB14WSZS	48 x 168 x 29	100	164.25	20.05	\$2343	\$1171
	• ships in two pieces							
16 foot	self edge	GB16WS	48 x 192 x 29	92.5	257.18	23.05	\$2343	\$1171
	bullnose edge	GB16WSBN	48 x 192 x 29	92.5	257.18	23.05	\$2343	\$1171
	T-mold edge	GB16WSTM	48 x 192 x 29	92.5	257.18	23.05	\$2343	\$1171
	built-up self edge	GB16WSBU	48 x 192 x 29	85	289.20	23.05	\$2540	\$1270
	slant edge	GB16WSZS	48 x 192 x 29	92.5	257.18	23.05	\$2343	\$1171
	• ships in two pieces							

Required Specifications

Finish
Base Finish
Edge Color, if applicable

Optional Specifications

Grommet

Accessories

Power Block

BOAT TOP - SCULPTED BASE

		MODEL#	DIMENSIONS	FREIGHT CLASS	WT/LBS.	CUBIC FT.	LIST PRICE	HP ADD
		D x W x H						
18 foot	self edge	GB18WS	48 x 216 x 29	85	390	26.10	\$2829	\$1414
	bullnose edge	GB18WSBN	48 x 216 x 29	85	390	26.10	\$2829	\$1414
	T-mold edge	GB18WSTM	48 x 216 x 29	85	390	26.10	\$2829	\$1414
	built-up self edge	GB18WSBU	48 x 216 x 29	70	426	26.10	\$3026	\$1513
	slant edge	GB18WSZS	48 x 216 x 29	85	390	26.10	\$2829	\$1414
		• ships in two pieces						
20 foot	self edge	GB20WS	48 x 240 x 29	250	492.20	189.2	\$3221	\$1610
	bullnose edge	GB20WSBN	48 x 240 x 29	250	492.20	189.2	\$3221	\$1610
	T-mold edge	GB20WSTM	48 x 240 x 29	250	492.20	189.2	\$3221	\$1610
	built-up self edge	GB20WSBU	48 x 240 x 29	250	532.20	189.2	\$3418	\$1709
	slant edge	GB20WSZS	48 x 240 x 29	250	492.20	189.2	\$3221	\$1610
		• ships in two pieces						
22 foot	self edge	GB22WS	48 x 264 x 29	250	509.50	204.3	\$3613	\$1806
	bullnose edge	GB22WSBN	48 x 264 x 29	250	509.50	204.3	\$3613	\$1806
	T-mold edge	GB22WSTM	48 x 264 x 29	250	509.50	204.3	\$3613	\$1806
	built-up self edge	GB22WSBU	48 x 264 x 29	250	553.50	204.3	\$3808	\$1904
	slant edge	GB22WSZS	48 x 264 x 29	250	509.50	204.3	\$3613	\$1806
		• ships in two pieces						
24 foot	self edge	GB24WS	48 x 288 x 29	250	542.20	225.2	\$4015	\$2007
	bullnose edge	GB24WSBN	48 x 288 x 29	250	542.20	225.2	\$4015	\$2007
	T-mold edge	GB24WSTM	48 x 288 x 29	250	542.20	225.2	\$4015	\$2007
	built-up self edge	GB24WSBU	48 x 288 x 29	250	590.20	225.2	\$4211	\$2105
	slant edge	GB24WSZS	48 x 288 x 29	250	542.20	225.2	\$4015	\$2007
		• ships in two pieces						

- All tops over 144" are standard in two pieces. Woodgrain laminate finishes will NOT align where the two tops join.
- All tops 120", 144", 168" and 192" are SHIPPED WITH 3 SCULPTED BASES.
- All tops 216" and 240" are SHIPPED WITH 4 SCULPTED BASES.
- All tops 264" and 288" are SHIPPED WITH 5 SCULPTED BASES.

Required Specifications

Finish
Base Finish
Edge Color, if applicable

Optional Specifications

Grommet

Accessories

Power Block

ELLIPTICAL TOP - SCULPTED BASE

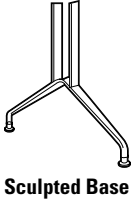
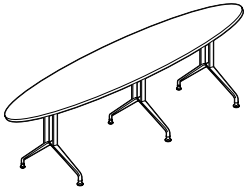

		MODEL#	DIMENSIONS	FREIGHT CLASS	WT/LBS.	CUBIC FT.	LIST PRICE	HP ADD
		D x W x H						
5 foot	self edge	GEL5S	30 x 60 x 29	150	91.40	17.96	\$893	\$446
	bullnose edge	GEL5SBN	30 x 60 x 29	150	91.40	17.96	\$893	\$446
	T-mold edge	GEL5STM	30 x 60 x 29	150	91.40	17.96	\$893	\$446
	built-up self edge	GEL5SBU	30 x 60 x 29	150	91.40	17.96	\$1034	\$517
	slant edge	GEL5SZS	30 x 60 x 29	150	91.40	17.96	\$893	\$446
		• ships in one piece						
6 foot	self edge	GEL6S	36 x 72 x 29	85	97.40	7.48	\$978	\$489
	bullnose edge	GEL6SBN	36 x 72 x 29	150	97.40	22.40	\$978	\$489
	T-mold edge	GEL6STM	36 x 72 x 29	150	97.40	22.40	\$978	\$489
	built-up self edge	GEL6SBU	36 x 72 x 29	150	106.40	22.40	\$1117	\$558
	slant edge	GEL6SZS	36 x 72 x 29	150	97.40	22.40	\$978	\$489
		• ships in one piece						
7 foot	self edge	GEL7S	44 x 84 x 29	250	91.40	33.77	\$1120	\$560
	bullnose edge	GEL7SBN	44 x 84 x 29	250	91.40	33.77	\$1120	\$560
	T-mold edge	GEL7STM	44 x 84 x 29	250	91.40	33.77	\$1120	\$560
	built-up self edge	GEL7SBU	44 x 84 x 29	250	123.70	33.77	\$1260	\$630
	slant edge	GEL7SZS	44 x 84 x 29	250	91.40	33.77	\$1120	\$560
		• ships in one piece						
8 foot	self edge	GEL8WS	48 x 96 x 29	250	137.40	38.29	\$1120	\$560
	bullnose edge	GEL8WSBN	48 x 96 x 29	250	137.40	38.29	\$1120	\$560
	T-mold edge	GEL8WSTM	48 x 96 x 29	250	137.40	38.29	\$1120	\$560
	built-up self edge	GEL8WSBU	48 x 96 x 29	150	153.40	12.79	\$1260	\$630
	slant edge	GEL8WSZS	48 x 96 x 29	250	137.40	12.79	\$1120	\$560
		• ships in one piece						
10 foot	self edge	GEL10WS	48 x 120 x 29	70	244.10	15.80	\$1567	\$783
	bullnose edge	GEL10WSBN	48 x 120 x 29	70	244.10	15.80	\$1567	\$783
	T-mold edge	GEL10WSTM	48 x 120 x 29	70	244.10	15.80	\$1567	\$783
	built-up self edge	GEL10WSBU	48 x 120 x 29	70	264.10	15.80	\$1708	\$854
	slant edge	GEL10WSZS	48 x 120 x 29	70	244.10	15.80	\$1567	\$783
		• ships in one piece						
12 foot	self edge	GEL12WS	48 x 144 x 29	85	269.10	18.80	\$1736	\$868
	bullnose edge	GEL12WSBN	48 x 144 x 29	85	269.10	18.80	\$1736	\$868
	T-mold edge	GEL12WSTM	48 x 144 x 29	125	269.10	37.62	\$1736	\$868
	built-up self edge	GEL12WSBU	48 x 144 x 29	70	293.10	18.80	\$1875	\$937
	slant edge	GEL12WSZS	48 x 144 x 29	85	269.10	18.80	\$1736	\$868
		• ships in one piece						
14 foot	self edge	GEL14WS	48 x 168 x 29	100	164.25	20.05	\$2343	\$1171
	bullnose edge	GEL14WSBN	48 x 168 x 29	100	164.25	20.05	\$2343	\$1171
	T-mold edge	GEL14WSTM	48 x 168 x 29	100	164.25	20.05	\$2343	\$1171
	built-up self edge	GEL14WSBU	48 x 168 x 29	100	192.30	20.05	\$2540	\$1270
	slant edge	GEL14WSZS	48 x 168 x 29	100	164.25	20.05	\$2343	\$1171
		• ships in two pieces						
16 foot	self edge	GEL16WS	48 x 192 x 29	92.5	257.18	23.05	\$2343	\$1171
	bullnose edge	GEL16WSBN	48 x 192 x 29	92.5	257.18	23.05	\$2343	\$1171
	T-mold edge	GEL16WSTM	48 x 192 x 29	92.5	257.18	23.05	\$2343	\$1171
	built-up self edge	GEL16WSBU	48 x 192 x 29	85	289.20	23.05	\$2540	\$1270
	slant edge	GEL16WSZS	48 x 192 x 29	92.5	257.18	23.05	\$2343	\$1171
		• ships in two pieces						

Required Specifications

Finish
Base Finish
Edge Color, if applicable

Optional Specifications

Grommet

Accessories

Power Block

ELLIPTICAL TOP - SCULPTED BASE

	MODEL#	DIMENSIONS	FREIGHT CLASS	WT/LBS.	CUBIC FT.	LIST PRICE	HP ADD
D x W x H							
18 foot	self edge	GEL18WS	48 x 216 x 29	85	390	26.10	\$3154 \$1577
	bullnose edge	GEL18WSBN	48 x 216 x 29	85	390	26.10	\$3154 \$1577
	T-mold edge	GEL18WSTM	48 x 216 x 29	85	390	26.10	\$3154 \$1577
	built-up self edge	GEL18WSBU	48 x 216 x 29	70	426	26.10	\$3352 \$1676
	slant edge	GEL18WSZS	48 x 216 x 29	85	390	26.10	\$3154 \$1577
	• ships in two pieces						
20 foot	self edge	GEL20WS	48 x 240 x 29	70	492.20	31.50	\$3605 \$1802
	bullnose edge	GEL20WSBN	48 x 240 x 29	70	492.20	31.50	\$3605 \$1802
	T-mold edge	GEL20WSTM	48 x 240 x 29	70	492.20	31.50	\$3605 \$1802
	built-up self edge	GEL20WSBU	48 x 240 x 29	70	532.20	31.50	\$3799 \$1899
	slant edge	GEL20WSZS	48 x 240 x 29	70	492.20	31.50	\$3605 \$1802
	• ships in two pieces						
22 foot	self edge	GEL22WS	48 x 264 x 29	85	509.20	34.01	\$3960 \$1980
	bullnose edge	GEL22WSBN	48 x 264 x 29	85	509.20	34.01	\$3960 \$1980
	T-mold edge	GEL22WSTM	48 x 264 x 29	85	509.20	34.01	\$3960 \$1980
	built-up self edge	GEL22WSBU	48 x 264 x 29	70	553.20	34.01	\$4155 \$2077
	slant edge	GEL22WSZS	48 x 264 x 29	85	509.20	34.01	\$3960 \$1980
	• ships in two pieces						
24 foot	self edge	GEL24WS	48 x 288 x 29	85	542.20	37.54	\$4351 \$2175
	bullnose edge	GEL24WSBN	48 x 288 x 29	85	542.20	37.54	\$4351 \$2175
	T-mold edge	GEL24WSTM	48 x 288 x 29	85	542.20	37.54	\$4351 \$2175
	built-up self edge	GEL24WSBU	48 x 288 x 29	70	590.20	37.54	\$4547 \$2273
	slant edge	GEL24WSZS	48 x 288 x 29	85	542.20	37.54	\$4351 \$2175
	• ships in two pieces						

- All tops over 144" are standard in two pieces. Woodgrain laminate finishes will NOT align where the two tops join.
- All tops 120", 144", 168" and 192" are SHIPPED WITH 3 SCULPTED BASES.
- All tops 216" and 240" are SHIPPED WITH 4 SCULPTED BASES.
- All tops 264" and 288" are SHIPPED WITH 5 SCULPTED BASES.

Required Specifications

Finish
Base Finish
Edge Color, if applicable

Optional Specifications

Grommet

Accessories

Power Block

B BOARDROOM TABLES



Sturdy and economically priced, Global boardroom tables are excellent choices. All tables are made from thermally fused, high performance laminate and are easy to maintain.

Choose from four attractive table edges: Bullnose, T-mold, Self-edge, or Built-up Self-edge. Available in a variety of colors, all edge options are durable and wear-resistant.

Table tops are offered in five shapes - rectangular, racetrack, boat-shaped, square and round - and a variety of bases including slab, drum and arch. Add to this an impressive variety of laminate finishes that may be mixed and matched and you'll find Global can satisfy any and every business need.

From small meeting rooms to large boardrooms, from traditional to contemporary, Global's incredible range of table components, shapes, sizes and colors will enhance any office decor.



Features and Benefits

- One-piece tops can be cut to 2 pieces for an upcharge
- Tables 96" to 144" in length special ordered with two piece tops must have a third base
- All tops are premarked as to base location
- All tops are 1 1/8" thick - a 1/4" built-up self edge is available on all models
- Tops and bases boxed as appropriate
- Custom finish laminate tables available as special order
- Bullnose edges available in Black or Grey
- T-Mold edge available in Black, Grey or coordinating laminate finish.
- Self-edge and built-up self edge available in same color as laminate finish.
- All edges available on all tables
- Metal legs and bases are standard in Chrome - also available in Black or Grey

GENERAL INFORMATION

- All tables are 29" high and constructed of 45 lb. density particle board
- Tables 144" or less are standard in one piece
- All tops over 144" are standard in two pieces
- Five top shapes: Rectangular, Racetrack, Boat-Shaped, Square and Round
- Four edge options: Bullnose, T-Mold, Self-edge or Built-Up Self Edge
- Global laminate and seating products are in compliance with stringent emission guidelines set out by the Greenguard Environmental Institute under the standards for low emitting products and materials. www.greenguard.org
- **Level 2 Certified**

CONSTRUCTION

- All Boardroom tables are 29" high and made of 45 lb. density particle board covered on both sides with high performance, thermally fused laminate. Table width is nominal.
- All tables with cross bases use Blum fasteners
- All tops are 1 1/8" thick with high performance, thermally fused laminate on both sides. A 1 3/4" built-up self edge is available on all models.
- Tops are crated and bases boxed or crated as appropriate
- Table tops of 144" or less in length are standard as one piece. 1 piece tops can be cut to 2 piece tops, **ADD \$204.00**; however, an additional base will be required. Tables 96" to 144" in length special ordered with 2 piece tops **must** have a third base.
- All Tops are **PREMARKED** as to base location, and the slot and hook assembly method (on selected tables) allows for easy installation.
- All racetrack, boat and rectangular tables 144" and under are standard with 2 drum, slab, arch, 2-legged, or tubular bases and are priced accordingly. For 3 bases, **ADD \$285.00** list per table for a drum, and **ADD \$220.00** list per table for the slab. The arch base tables will require a special 3" thick slab at a list price of **\$299.00** per table. **ADD \$285.00** list per table for 2-legged base, and **ADD \$299.00** list per table for tubular.
- Custom size tables are priced at next size table price, not to exceed width or length. Example: 44" x 108" would be priced at the 48" x 120" price. Contact Customer Service for pricing of tables over 48" in width. Custom tables **less** than the smallest size must be quoted.

EDGE OPTIONS

- Self, built-up, bullnose, T-mold and slant edges are available on all models. Corners of rectangular, square and boat shaped tables ordered with T-mold or bullnose will be rounded.
- **Bullnose** edge is available in Black (**BK**) or Grey (**GR**) only.
- **T-mold** edge is available in Black (**BK**), Grey (**GR**) or coordinating laminate finish (**ME**)
- **Self edge and built-up** edges are same color as laminate finish.
- Metal bases are standard in Chrome (**CH**). Also available in Black (**BLK**) or Grey (**GR**). Please specify when ordering if a color other than Chrome is desired.

LAMINATE FINISHES

ACJ	Absolute Acajou	ASN	Asian Night
AWC	Avant Cherry	AWH	Avant Honey
BLK	Black	BRC	Brushed Cobalt
CSJ	Constellation Java	DES	Dark Espresso
GRY	Grey	HGT	Hayden Grey
QTM	Quartered Mahogany	SKC	Shaker Cherry
SOG	Storm Grey	TFW	Tiger Fruitwood
TMA	Tiger Mahogany	TMP	Tiger Maple
TWL	Tiger Walnut	WHT	White
WHC	White Chocolate*	WGY	Willow Grey
WCR	Winter Cherry		<i>*textured</i>

- White Chocolate (**WHC**) not available on 10 & 12 foot tables. Must be cut in two pieces and specify third base.
- The above laminate finishes are available in **High Pressure**. Upcharge varies by model.
- Tables in woodgrain finishes over 12' in length will not have a perfect match of grain at the center where the two halves meet.
- All tables with Drum Bases & Pedestal require approx. 125 lb. of sand in each base for adequate stability. Sand is not included with Drum Bases.

- If other than a Global standard laminate finish is preferred, contact your Customer Care Representative. Information needed includes the name of the laminate manufacturer, color name, number and model of table. You will then be given a quote for this special order.

BASE SIZE CHART (Table width is nominal)

Round or Square Tops:

Top	Slab	Drum	Arch	Cross	4 Leg	Trumpet	4 Tube
36"	n/a	n/a	n/a	n/a	32"	24"	30"
42"	n/a	18"	n/a	30"	32"	24"	30"
48"	n/a	24"	n/a	30"	32"	n/a	30"
60"	n/a	30"	n/a	36"	n/a	n/a	n/a

Rectangular, Boat or Racetrack Tops:

Top	Slab	Drum	Arch	Cross	2 Leg	Trumpet	2/3 Tube
36" x 72"	24"	18"	24"	n/a	32"	n/a	30"
48" x 96"	28"	18"	28"	n/a	32"	n/a	30"
48" x 120"	28"	24"	28"	n/a	32"	n/a	30"
48" x 144"	28"	24"	28"	n/a	32"	n/a	30"

GROMMETS

- Grommets available in standard table top locations (left, center or right). Order as: **AG1, AG2 or AG3.....Add \$65**
- Grommet hole dimensions are 3 1/4" wide x 1 7/8" deep.



- Actual grommet locations will vary according to base selection.

POWER BLOCK

- A Power Block (model **PMSPPM**) may be ordered on all worksurfaces.
- A Power Block is a rectangular worksurface power/data module with one electrical duplex receptacle and two data (RJ45) receptacles. 9' black cord included. Power Block dimensions are 3 1/2" deep x 6 1/2" wide x 2 3/4" high.
- Actual Power Block locations vary according to base selection. The locations will be left (AG1, E1), center (AG2, E2), and right (AG3, E3). **Example:** 8' table with drum base does not have a modesty panel, so the grommet (AG2) and power block (E2) can be perfectly centered in the table. An 8' table with a slab base has the modesty panel, so the grommet (AG2) and power block (E2) will be offset alongside the modesty panel.
- To purchase a Power Block, you must specify both the Power Block cut-out location and the Power Block model #. Order Power Block as **PMSPPM, ADD \$238**. Power Blocks are available in standard worksurface locations (left, center or right). Order as **E1, E2 or E3. ADD \$65.00**.

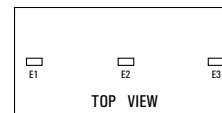

Power Block **PMSPPM Add \$238** Specify location **E1, E2 or E3 Add \$65**

B BOARDROOM TABLES

TABLE NOTES - ESTIMATED CAPACITY

• Use the following for determining the size of a round table and the number of chairs needed for a conference area. All estimates are based on an average chair width of 23" with a 4" clearance between chairs. Adjust accordingly for a different chair size.

Top Size	Round	Square	Rectangular	Boat	Racetrack	Elliptical
30x30	3	3	N/A	N/A	N/A	N/A
36x36	4	4	N/A	N/A	N/A	N/A
42x42	4	4	N/A	N/A	N/A	N/A
48x48	4	4	N/A	N/A	N/A	N/A
60x60	5	6	N/A	N/A	N/A	N/A
30x60	N/A	N/A	4-6	4-6	4-6	4
36x72	N/A	N/A	4-6	4-6	4-6	4
44x84	N/A	N/A	6-8	6-8	6-8	6
48x96	N/A	N/A	6-8	6-8	6-8	6
48x120	N/A	N/A	8-10	8-10	8-10	8
48x144	N/A	N/A	10-12	10-12	10-12	10
48x168	N/A	N/A	12-14	12-14	12-14	12
48x192	N/A	N/A	14-16	14-16	14-16	14
48x216	N/A	N/A	16-18	16-18	16-18	16
48x240	N/A	N/A	18-20	18-20	18-20	18
48x264	N/A	N/A	20-22	20-22	20-22	20
48x288	N/A	N/A	22-24	22-24	22-24	22

BASE OPTIONS

EDGE OPTIONS

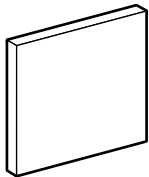

Slab

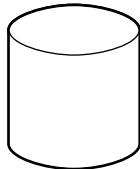

Drum

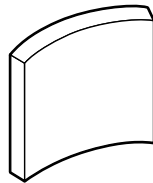

Arch

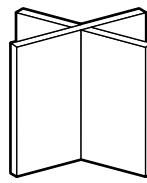

Cross

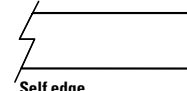

Self edge

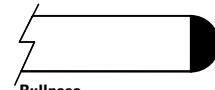

Bullnose

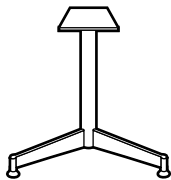

2-Leg



4-Leg

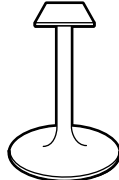

Trumpet

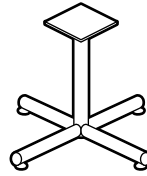

Tube

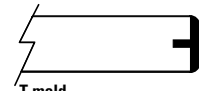

T-mold

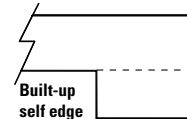

Built-up self edge

TABLE TOP STYLES

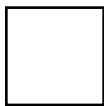

Square

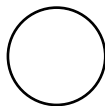

Round



Racetrack

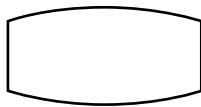

Boat



Rectangular

ROUND TOP - DRUM BASE

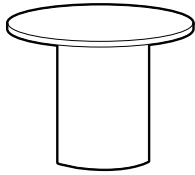

	MODEL#	DIMENSIONS	FREIGHT	CLASS	WT./LBS.	CUBIC FT.	LIST PRICE	HP ADD
		D x W x H						
self edge	G42CZ	0 x 42 x 29	92.5	89	8.50	\$613	\$306	
bullnose edge	G42CZBN	0 x 42 x 29	92.5	86	8.50	\$613	\$306	
T-mold edge	G42CZTM	0 x 42 x 29	92.5	90	8.50	\$613	\$306	
built-up self edge	G42CZBU	0 x 42 x 29	92.5	96	9.40	\$680	\$340	
self edge	G48CZ	0 x 48 x 29	125	106	13.60	\$708	\$354	
bullnose edge	G48CZBN	0 x 48 x 29	100	117	13.60	\$708	\$354	
T-mold edge	G48CZTM	0 x 48 x 29	100	121	13.60	\$708	\$354	
built-up self edge	G48CZBU	0 x 48 x 29	100	133	14.90	\$789	\$394	
self edge	G60CZ	0 x 60 x 29	100	171	21	\$887	\$443	
bullnose edge	G60CZBN	0 x 60 x 29	100	171	21	\$887	\$443	
T-mold edge	G60CZTM	0 x 60 x 29	100	171	21	\$887	\$443	
built-up self edge	G60CZBU	0 x 60 x 29	125	174	23.20	\$1045	\$522	

• All Drum Bases require approx. 125 lb. of sand in each base for adequate stability. Sand is not included.

ROUND TOP - CROSS BASE

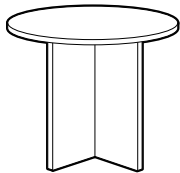

self edge	G42CH	0 x 42 x 29	70	97	5	\$568	\$284
bullnose edge	G42CHBN	0 x 42 x 29	70	94	5	\$568	\$284
T-mold edge	G42CHTM	0 x 42 x 29	70	98	5	\$568	\$284
built-up self edge	G42CHBU	0 x 42 x 29	70	104	5.70	\$613	\$306
self edge	G48CH	0 x 48 x 29	70	101	6	\$664	\$332
bullnose edge	G48CHBN	0 x 48 x 29	70	112	6	\$664	\$332
T-mold edge	G48CHTM	0 x 48 x 29	70	116	6	\$664	\$332
built-up self edge	G48CHBU	0 x 48 x 29	70	128	6.60	\$761	\$380
self edge	G60CH	0 x 60 x 29	70	174	9	\$850	\$425
bullnose edge	G60CHBN	0 x 60 x 29	125	64	9	\$850	\$425
T-mold edge	G60CHTM	0 x 60 x 29	125	64	9	\$850	\$425
built-up self edge	G60CHBU	0 x 60 x 29	70	190	9.70	\$1002	\$501

ROUND TOP - 4 LEG BASE



self edge	GCAR36	0 x 36 x 29	250	48	13	\$412	\$206
bullnose edge	GCAR36BN	0 x 36 x 29	150	55	13	\$412	\$206
T-mold edge	GCAR36TM	0 x 36 x 29	250	48	13	\$412	\$206
built-up self edge	GCAR36BU	0 x 36 x 29	150	68	13	\$459	\$229
self edge	GCAR42	0 x 42 x 29	150	59	14	\$492	\$246
bullnose edge	GCAR42BN	0 x 42 x 29	150	68	14	\$492	\$246
T-mold edge	GCAR42TM	0 x 42 x 29	150	61	14	\$492	\$246
built-up self edge	GCAR42BU	0 x 42 x 29	150	78	14	\$543	\$271
self edge	GCAR48	0 x 48 x 29	150	72	15	\$577	\$288
bullnose edge	GCAR48BN	0 x 48 x 29	150	83	15	\$577	\$288
T-mold edge	GCAR48TM	0 x 48 x 29	150	87	15	\$577	\$288
built-up self edge	GCAR48BU	0 x 48 x 29	125	99	15	\$640	\$320

Required Specifications

Finish
Base Finish
Edge Color, if applicable

B BOARDROOM TABLES

ROUND TOP - TRUMPET BASE

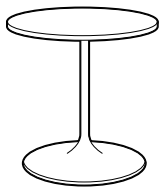

	MODEL#	DIMENSIONS	FREIGHT	CLASS	WT/LBS.	CUBIC FT.	LIST PRICE	HP ADD
		D x W x H						
self edge	GTCR36	0 x 36 x 29	250	54	19	\$577	\$288	
bullnose edge	GTCR36BN	0 x 36 x 29	250	61	18	\$577	\$288	
T-mold edge	GTCR36TM	0 x 36 x 29	250	54	18	\$577	\$288	
built-up self edge	GTCR36BU	0 x 36 x 29	150	74	18	\$640	\$320	
self edge	GTCR42	0 x 42 x 29	150	77	19	\$648	\$324	
bullnose edge	GTCR42BN	0 x 42 x 29	250	74	19	\$648	\$324	
T-mold edge	GTCR42TM	0 x 42 x 29	150	78	19	\$648	\$324	
built-up self edge	GTCR42BU	0 x 42 x 29	150	84	19	\$721	\$360	

ROUND TOP - TUBULAR BASE



self edge	GCCR36	0 x 36 x 29	250	50	18	\$498	\$249
bullnose edge	GCCR36BN	0 x 36 x 29	250	57	19	\$498	\$249
T-mold edge	GCCR36TM	0 x 36 x 29	250	50	19	\$498	\$249
built-up self edge	GCCR36BU	0 x 36 x 29	250	70	19	\$554	\$277
self edge	GCCR42	0 x 42 x 29	250	61	19	\$577	\$288
bullnose edge	GCCR42BN	0 x 42 x 29	250	70	19	\$577	\$288
T-mold edge	GCCR42TM	0 x 42 x 29	250	63	19	\$577	\$288
built-up self edge	GCCR42BU	0 x 42 x 29	150	80	19	\$640	\$320
self edge	GCCR48	0 x 48 x 29	250	74	20	\$664	\$332
bullnose edge	GCCR48BN	0 x 48 x 29	150	85	20	\$664	\$332
T-mold edge	GCCR48TM	0 x 48 x 29	150	89	20	\$664	\$332
built-up self edge	GCCR48BU	0 x 48 x 29	150	101	20	\$734	\$367

SQUARE TOP - DRUM BASE

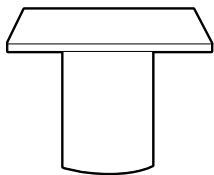

self edge	G42SZ	42 x 42 x 29	100	89	9	\$613	\$306
bullnose edge	G42SZBN	42 x 42 x 29	100	89	9	\$613	\$306
T-mold edge	G42SZTM	42 x 42 x 29	100	89	9	\$613	\$306
built-up self edge	G42SZBU	42 x 42 x 29	92.5	106	9.40	\$680	\$340
self edge	G48SZ	48 x 48 x 29	100	121	13.40	\$708	\$354
bullnose edge	G48SZBN	48 x 48 x 29	100	121	13.40	\$708	\$354
T-mold edge	G48SZTM	48 x 48 x 29	100	121	13.60	\$708	\$354
built-up self edge	G48SZBU	48 x 48 x 29	100	133	14.90	\$789	\$394
self edge	G60SZ	60 x 60 x 29	100	171	21	\$887	\$443
bullnose edge	G60SZBN	60 x 60 x 29	100	171	21	\$887	\$443
T-mold edge	G60SZTM	60 x 60 x 29	100	171	21	\$887	\$443
built-up self edge	G60SZBU	60 x 60 x 29	125	174	23.20	\$1045	\$522

- All Drum Bases require approx. 125 lb. of sand in each base for adequate stability. Sand is not included.

SQUARE TOP - CROSS BASE

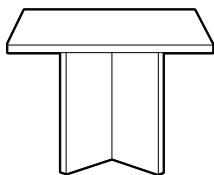

self edge	G42SH	42 x 42 x 29	70	97	5	\$568	\$284
bullnose edge	G42SHBN	42 x 42 x 29	70	97	5	\$568	\$284
T-mold edge	G42SHTM	42 x 42 x 29	70	97	5	\$568	\$284
built-up self edge	G42SHBU	42 x 42 x 29	70	114	5.70	\$613	\$306
self edge	G48SH	48 x 48 x 29	70	116	6	\$664	\$332
bullnose edge	G48SHBN	48 x 48 x 29	70	116	6	\$664	\$332
T-mold edge	G48SHTM	48 x 48 x 29	70	116	6	\$664	\$332
built-up self edge	G48SHBU	48 x 48 x 29	70	122	6.40	\$761	\$380
self edge	G60SH	60 x 60 x 29	125	64	9	\$850	\$425
bullnose edge	G60SHBN	60 x 60 x 29	125	64	9	\$850	\$425
T-mold edge	G60SHTM	60 x 60 x 29	125	64	9	\$850	\$425
built-up self edge	G60SHBU	60 x 60 x 29	125	64	9.70	\$1002	\$501

Required Specifications

- Finish
- Base Finish
- Edge Color, if applicable

SQUARE TOP - 4 LEG BASE



	MODEL#	DIMENSIONS	FREIGHT CLASS	WT/LBS.	CUBIC FT.	LIST PRICE	HP ADD
D x W x H							
self edge	GCAS36	36 x 36 x 29	150	63	13	\$412	\$206
bullnose edge	GCAS36BN	36 x 36 x 29	150	63	13	\$412	\$206
T-mold edge	GCAS36TM	36 x 36 x 29	150	63	13	\$412	\$206
built-up self edge	GCAS36BU	36 x 36 x 29	150	67	13	\$459	\$229
self edge	GCAS42	42 x 42 x 29	150	71	14	\$492	\$246
bullnose edge	GCAS42BN	42 x 42 x 29	150	78	14	\$492	\$246
T-mold edge	GCAS42TM	42 x 42 x 29	150	78	14	\$492	\$246
built-up self edge	GCAS42BU	42 x 42 x 29	125	86	14	\$543	\$271
self edge	GCAS48	48 x 48 x 29	125	97	15	\$577	\$288
bullnose edge	GCAS48BN	48 x 48 x 29	125	97	15	\$577	\$288
T-mold edge	GCAS48TM	48 x 48 x 29	125	97	15	\$577	\$288
built-up self edge	GCAS48BU	48 x 48 x 29	125	108	15	\$640	\$320

SQUARE TOP - TRUMPET BASE



self edge	GTCS36	36 x 36 x 29	250	69	18	\$577	\$288
bullnose edge	GTCS36BN	36 x 36 x 29	250	69	18	\$577	\$288
T-mold edge	GTCS36TM	36 x 36 x 29	250	69	18	\$577	\$288
built-up self edge	GTCS36BU	36 x 36 x 29	150	76	18	\$640	\$320
self edge	GTCS42	42 x 42 x 29	150	77	19	\$648	\$324
bullnose edge	GTCS42BN	42 x 42 x 29	150	77	19	\$648	\$324
T-mold edge	GTCS42TM	42 x 42 x 29	150	77	19	\$648	\$324
built-up self edge	GTCS42BU	42 x 42 x 29	150	84	19	\$721	\$360

SQUARE TOP - TUBULAR BASE



self edge	GCRS36	36 x 36 x 29	250	65	18	\$498	\$249
bullnose edge	GCRS36BN	36 x 36 x 29	250	65	18	\$498	\$249
T-mold edge	GCRS36TM	36 x 36 x 29	250	65	18	\$498	\$249
built-up self edge	GCRS36BU	36 x 36 x 29	250	69	18	\$554	\$277
self edge	GCRS42	42 x 42 x 29	250	73	19	\$577	\$288
bullnose edge	GCRS42BN	42 x 42 x 29	150	80	19	\$577	\$288
T-mold edge	GCRS42TM	42 x 42 x 29	150	80	19	\$577	\$288
built-up self edge	GCRS42BU	42 x 42 x 29	150	88	19	\$640	\$320
self edge	GCRS48	48 x 48 x 29	150	101	20	\$664	\$332
bullnose edge	GCRS48BN	48 x 48 x 29	150	101	20	\$664	\$332
T-mold edge	GCRS48TM	48 x 48 x 29	150	101	20	\$664	\$332
built-up self edge	GCRS48BU	48 x 48 x 29	150	109	20	\$734	\$367

Required Specifications

Finish
Base Finish
Edge Color, if applicable

B BOARDROOM TABLES

RECTANGULAR TOP - SLAB BASE

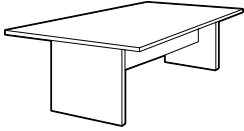

		MODEL#	DIMENSIONS	FREIGHT	CLASS	WT/LBS.	CUBIC FT.	LIST PRICE	HP ADD
		D x W x H							
5 foot	self edge	GCT5RX	30 x 60 x 29	70	131	6		\$718	\$359
	bullnose edge	GCT5RXBN	30 x 60 x 60	70	131	6		\$718	\$359
	T-mold edge	GCT5RXTM	30 x 60 x 29	70	131	6		\$718	\$359
	built-up self edge	GCT5RXBU	30 x 60 x 29	70	134	7		\$794	\$397
6 foot	self edge	GCT6RX	36 x 72 x 29	70	174	11.38		\$805	\$402
	bullnose edge	GCT6RXBN	36 x 72 x 29	70	174	11.38		\$805	\$402
	T-mold edge	GCT6RXTM	36 x 72 x 29	70	174	11.38		\$805	\$402
	built-up self edge	GCT6RXBU	36 x 72 x 29	85	177	13.32		\$898	\$449
7 foot	self edge	GCT7RX	44 x 84 x 29	85	199	14.94		\$1037	\$518
	bullnose edge	GCT7RXBN	44 x 84 x 29	85	199	14.94		\$1037	\$518
	T-mold edge	GCT7RXTM	44 x 84 x 84	85	199	14.94		\$1037	\$518
	built-up self edge	GCT7RXBU	44 x 84 x 84	92.5	203	17.93		\$1170	\$585
8 foot	self edge	GCT8WRX	48 x 96 x 29	70	218	11.29		\$1037	\$518
	bullnose edge	GCT8WRXBN	48 x 96 x 29	70	218	11.29		\$1037	\$518
	T-mold edge	GCT8WRXTM	48 x 96 x 29	70	218	11.29		\$1037	\$518
	built-up self edge	GCT8WRXBU	48 x 96 x 29	70	249	13.53		\$1170	\$585
10 foot	self edge	GCT10WRX2	48 x 120 x 29	70	272	13.53		\$1201	\$600
	bullnose edge	GCT10WRX2BN	48 x 120 x 29	70	272	13.53		\$1201	\$600
	T-mold edge	GCT10WRX2TM	48 x 120 x 29	70	272	13.53		\$1201	\$600
	built-up self edge	GCT10WRX2BU	48 x 120 x 29	70	291	16.20		\$1422	\$711
12 foot	self edge	GCT12WRX2	48 x 144 x 29	70	309	15.54		\$1411	\$705
	bullnose edge	GCT12WRX2BN	48 x 144 x 29	70	309	15.54		\$1411	\$705
	T-mold edge	GCT12WRX2TM	48 x 144 x 29	70	309	15.54		\$1411	\$705
	built-up self edge	GCT12WRX2BU	48 x 144 x 29	70	348	18.77		\$1656	\$828
14 foot	self edge	GCT14WRX2	48 x 168 x 29	70	419	22.50		\$2041	\$1020
	bullnose edge	GCT14WRX2BN	48 x 168 x 29	70	419	22.50		\$2041	\$1020
	T-mold edge	GCT14WRX2TM	48 x 168 x 29	65	419	18		\$2041	\$1020
	built-up self edge	GCT14WRX2BU	48 x 168 x 29	70	425	20		\$2278	\$1139
16 foot	self edge	GCT16WRX2	48 x 192 x 29	70	460	22.72		\$2127	\$1063
	bullnose edge	GCT16WRX2BN	48 x 192 x 29	70	460	22.72		\$2127	\$1063
	T-mold edge	GCT16WRX2TM	48 x 192 x 29	70	460	22.70		\$2127	\$1063
	built-up self edge	GCT16WRX2BU	48 x 192 x 29	70	466	27.20		\$2375	\$1187
18 foot	self edge	GCT18WRX2	48 x 216 x 29	70	521	24.60		\$2647	\$1323
	bullnose edge	GCT18WRX2BN	48 x 216 x 29	70	521	24.60		\$2647	\$1323
	T-mold edge	GCT18WRX2TM	48 x 216 x 29	70	521	24.60		\$2647	\$1323
	built-up self edge	GCT18WRX2BU	48 x 216 x 29	70	528	29.80		\$2967	\$1483
20 foot	self edge	GCT20WRX2	48 x 240 x 29	70	572	26.60		\$2689	\$1344
	bullnose edge	GCT20WRX2BN	48 x 240 x 29	70	572	26.60		\$2689	\$1344
	T-mold edge	GCT20WRX2TM	48 x 240 x 29	70	572	26.60		\$2689	\$1344
	built-up self edge	GCT20WRX2BU	48 x 240 x 29	70	580	32.50		\$3011	\$1505
22 foot	self edge	GCT22WRX2	48 x 264 x 29	70	612	28.90		\$3122	\$1561
	bullnose edge	GCT22WRX2BN	48 x 264 x 29	70	612	28.90		\$3122	\$1561
	T-mold edge	GCT22WRX2TM	48 x 264 x 29	70	612	28.90		\$3122	\$1561
	built-up self edge	GCT22WRX2BU	48 x 264 x 29	70	620	35.10		\$3448	\$1724
24 foot	self edge	GCT24WRX2	48 x 288 x 29	70	673	31.20		\$3210	\$1605
	bullnose edge	GCT24WRX2BN	48 x 288 x 29	70	673	31.20		\$3210	\$1605
	T-mold edge	GCT24WRX2TM	48 x 288 x 29	70	673	31.20		\$3210	\$1605
	built-up self edge	GCT24WRX2BU	48 x 288 x 29	70	682	37.70		\$3551	\$1775

- All tops over 144" are standard in two pieces. Woodgrain laminate finishes will NOT align where the two tops join.
- All tops 168", 192", 216" and 240" are SHIPPED WITH 3 SLAB BASES.
- All tops 264" and 288" are SHIPPED WITH 4 SLAB BASES.

Required Specifications

Finish
Base Finish
Edge Color, if applicable

Optional Specifications

Grommet

Accessories

Power Block

RECTANGULAR TOP - DRUM BASE

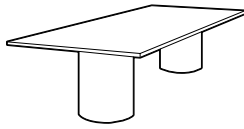

		MODEL#	DIMENSIONS	FREIGHT	CLASS	WT/LBS.	CUBIC FT.	LIST PRICE	HP ADD
		D x W x H							
6 foot	self edge	GCT6RZ	36 x 72 x 29	100	154	17.50	\$1088	\$544	
	bullnose edge	GCT6RZBN	36 x 72 x 29	100	167	17.50	\$1088	\$544	
	T-mold edge	GCT6RZTM	36 x 72 x 29	100	167	17.50	\$1088	\$544	
	built-up self edge	GCT6RZBU	36 x 72 x 29	100	177	18.80	\$1218	\$609	
7 foot	self edge	GCT7RZ	44 x 84 x 29	125	196	29.04	\$1261	\$630	
	bullnose edge	GCT7RZBN	44 x 84 x 29	125	196	29.04	\$1261	\$630	
	T-mold edge	GCT7RZTM	44 x 84 x 29	125	196	29.04	\$1261	\$630	
	built-up self edge	GCT7RZBU	44 x 84 x 29	125	199	31.66	\$1390	\$695	
8 foot	self edge	GCT8WRZ	48 x 96 x 29	125	219	31.82	\$1261	\$630	
	bullnose edge	GCT8WRZBN	48 x 96 x 29	125	219	31.82	\$1261	\$630	
	T-mold edge	GCT8WRZTM	48 x 96 x 29	125	219	31.82	\$1261	\$630	
	built-up self edge	GCT8WRZBU	48 x 96 x 29	125	250	35.18	\$1390	\$695	
10 foot	self edge	GCT10WRZ2	48 x 120 x 29	100	295	33	\$1478	\$739	
	bullnose edge	GCT10WRZ2BN	48 x 120 x 29	100	295	33	\$1478	\$739	
	T-mold edge	GCT10WRZ2TM	48 x 120 x 29	100	295	33.02	\$1478	\$739	
	built-up self edge	GCT10WRZ2BU	48 x 120 x 29	100	314	35.72	\$1630	\$815	
12 foot	self edge	GCT12WRZ2	48 x 144 x 29	100	328	35.10	\$1652	\$826	
	bullnose edge	GCT12WRZ2BN	48 x 144 x 29	100	328	35.10	\$1652	\$826	
	T-mold edge	GCT12WRZ2TM	48 x 144 x 29	250	97	35.10	\$1652	\$826	
	built-up self edge	GCT12WRZ2BU	48 x 144 x 29	250	367	96	\$1834	\$917	
14 foot	self edge	GCT14WRZ2	48 x 168 x 29	92.5	441	39	\$2215	\$1107	
	bullnose edge	GCT14WRZ2BN	48 x 168 x 29	92.5	441	39	\$2215	\$1107	
	T-mold edge	GCT14WRZ2TM	48 x 168 x 29	92.5	441	39	\$2215	\$1107	
	built-up self edge	GCT14WRZ2BU	48 x 168 x 29	92.5	447	42	\$2456	\$1228	
16 foot	self edge	GCT16WRZ2	48 x 192 x 29	92.5	482	42.50	\$2301	\$1150	
	bullnose edge	GCT16WRZ2BN	48 x 192 x 29	92.5	482	42.50	\$2301	\$1150	
	T-mold edge	GCT16WRZ2TM	48 x 192 x 29	92.5	482	42.50	\$2301	\$1150	
	built-up self edge	GCT16WRZ2BU	48 x 192 x 29	92.5	488	47	\$2540	\$1270	
18 foot	self edge	GCT18WRZ2	48 x 216 x 29	100	523	54.40	\$2994	\$1497	
	bullnose edge	GCT18WRZ2BN	48 x 216 x 29	100	523	54.40	\$2994	\$1497	
	T-mold edge	GCT18WRZ2TM	48 x 216 x 29	100	523	54.40	\$2994	\$1497	
	built-up self edge	GCT18WRZ2BU	48 x 216 x 29	100	550	59	\$3365	\$1682	
20 foot	self edge	GCT20WRZ2	48 x 240 x 29	100	564	66.20	\$3037	\$1518	
	bullnose edge	GCT20WRZ2BN	48 x 240 x 29	100	564	66.20	\$3037	\$1518	
	T-mold edge	GCT20WRZ2TM	48 x 240 x 29	100	564	66.20	\$3037	\$1518	
	built-up self edge	GCT20WRZ2BU	48 x 240 x 29	100	572	70.60	\$3410	\$1705	
22 foot	self edge	GCT22WRZ2	48 x 264 x 29	100	604	68.20	\$3383	\$1691	
	bullnose edge	GCT22WRZ2BN	48 x 264 x 29	100	604	68.20	\$3383	\$1691	
	T-mold edge	GCT22WRZ2TM	48 x 264 x 29	100	604	68.20	\$3383	\$1691	
	built-up self edge	GCT22WRZ2BU	48 x 264 x 29	100	612	73.68	\$3779	\$1889	
24 foot	self edge	GCT24WRZ2	48 x 288 x 29	100	646	70.20	\$3470	\$1735	
	bullnose edge	GCT24WRZ2BN	48 x 288 x 29	100	646	70.20	\$3470	\$1735	
	T-mold edge	GCT24WRZ2TM	48 x 288 x 29	100	646	70.20	\$3470	\$1735	
	built-up self edge	GCT24WRZ2BU	48 x 288 x 29	100	655	76.80	\$3861	\$1930	

- All Drum Bases require approx. 125 lb. of sand in each base for adequate stability. Sand is not included.
- All tops over 144" are standard in two pieces. Woodgrain laminate finishes will NOT align where the two tops join.
- All tops 168", 192" and 216" are SHIPPED WITH 3 DRUM BASES.
- All tops 240", 264" and 288" are SHIPPED WITH 4 DRUM BASES.

Required Specifications

Finish
Base Finish
Edge Color, if applicable

Optional Specifications

Grommet

Accessories

Power Block

B BOARDROOM TABLES

RECTANGULAR TOP - ARCH BASE

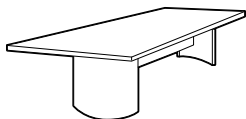

		MODEL#	DIMENSIONS	FREIGHT	CLASS	WT/LBS.	CUBIC FT.	LIST PRICE	HP ADD
		D x W x H							
5 foot	self edge	GCT5RA	30 x 60 x 29	85	131	9		\$958	
	bullnose edge	GCT5RABN	30 x 60 x 29	85	131	9		\$958	
	T-mold edge	GCT5RATM	30 x 60 x 29	85	131	9		\$958	
	built-up self edge	GCT5RABU	30 x 60 x 29	85	134	10		\$1087	
6 foot	self edge	GCT6RA	36 x 72 x 29	125	157	24.64		\$1001	
	bullnose edge	GCT6RABN	36 x 72 x 29	125	157	24.64		\$1001	
	T-mold edge	GCT6RATM	36 x 72 x 29	70	157	8.24		\$1001	
	built-up self edge	GCT6RABU	36 x 72 x 29	100	167	17.96		\$1190	
7 foot	self edge	GCT7RA	44 x 84 x 29	92.5	203	19.43		\$1219	
	bullnose edge	GCT7RABN	44 x 84 x 29	92.5	203	19.43		\$1219	
	T-mold edge	GCT7RATM	44 x 84 x 29	92.5	203	19.43		\$1219	
	built-up self edge	GCT7RABU	44 x 84 x 29	100	206	20.90		\$1382	
8 foot	self edge	GCT8WRA	48 x 96 x 29	100	220	22.40		\$1219	
	bullnose edge	GCT8WRABN	48 x 96 x 29	100	220	22.40		\$1219	
	T-mold edge	GCT8WRATM	48 x 96 x 29	100	220	22.40		\$1219	
	built-up self edge	GCT8WRABU	48 x 96 x 29	92.5	251	23.89		\$1382	
10 foot	self edge	GCT10WRA	48 x 120 x 29	70	274	16.95		\$1391	
	bullnose edge	GCT10WRABN	48 x 120 x 29	70	274	16.95		\$1391	
	T-mold edge	GCT10WRATM	48 x 120 x 29	70	274	16.95		\$1391	
	built-up self edge	GCT10WRABU	48 x 120 x 29	70	293	18.92		\$1640	
12 foot	self edge	GCT12WRA	48 x 144 x 29	70	311	19.94		\$1608	
	bullnose edge	GCT12WRABN	48 x 144 x 29	70	311	19.94		\$1608	
	T-mold edge	GCT12WRATM	48 x 144 x 29	70	311	19.94		\$1608	
	built-up self edge	GCT12WRABU	48 x 144 x 29	70	350	21.92		\$1878	
14 foot	self edge	GCT14WRA	48 x 168 x 29	70	423	26		\$2476	
	bullnose edge	GCT14WRABN	48 x 168 x 29	70	423	26		\$2476	
	T-mold edge	GCT14WRATM	48 x 168 x 29	70	423	26		\$2476	
	built-up self edge	GCT14WRABU	48 x 168 x 29	70	429	28		\$2759	
16 foot	self edge	GCT16WRA	48 x 192 x 29	70	474	30		\$2604	
	bullnose edge	GCT16WRABN	48 x 192 x 29	70	474	30		\$2604	
	T-mold edge	GCT16WRATM	48 x 192 x 29	70	474	30		\$2604	
	built-up self edge	GCT16WRABU	48 x 192 x 29	70	480	32		\$2912	
18 foot	self edge	GCT18WRA	48 x 216 x 29	70	525	31.92		\$3210	
	bullnose edge	GCT18WRABN	48 x 216 x 29	70	525	31.92		\$3210	
	T-mold edge	GCT18WRATM	48 x 216 x 29	70	525	31.92		\$3210	
	built-up self edge	GCT18WRABU	48 x 216 x 29	70	532	33.89		\$3586	
20 foot	self edge	GCT20WRA	48 x 240 x 29	70	576	33.89		\$3256	
	bullnose edge	GCT20WRABN	48 x 240 x 29	70	576	33.89		\$3256	
	T-mold edge	GCT20WRATM	48 x 240 x 29	70	576	33.89		\$3256	
	built-up self edge	GCT20WRABU	48 x 240 x 29	70	584	35.93		\$3621	
22 foot	self edge	GCT22WRA	48 x 264 x 29	70	626	36.89		\$3640	
	bullnose edge	GCT22WRABN	48 x 264 x 29	70	626	36.89		\$3640	
	T-mold edge	GCT22WRATM	48 x 264 x 29	70	626	36.89		\$3640	
	built-up self edge	GCT22WRABU	48 x 264 x 29	70	634	37.90		\$4070	
24 foot	self edge	GCT24WRA	48 x 288 x 29	70	678	40		\$3728	
	bullnose edge	GCT24WRABN	48 x 288 x 29	70	678	40		\$3728	
	T-mold edge	GCT24WRATM	48 x 288 x 29	70	678	40		\$3728	
	built-up self edge	GCT24WRABU	48 x 288 x 29	70	687	42		\$4153	

- All tops over 144" are standard in two pieces. Woodgrain laminate finishes will NOT align where the two tops join.
- All tops 168", 192", 216" and 240" are SHIPPED WITH 2 ARCH BASES AND 1 SLAB BASE.
- All tops 264" and 288" are SHIPPED WITH 2 ARCH BASES AND 2 SLAB BASES.

Required Specifications

Finish
Base Finish
Edge Color, if applicable

Optional Specifications

Grommet

Accessories

Power Block

RECTANGULAR TOP - 2 LEG BASE



	MODEL#	DIMENSIONS	FREIGHT	CLASS	WT/LBS.	CUBIC FT.	LIST PRICE	HP ADD
	D x W x H							
5 foot	self edge	GCT5R	30 x 60 x 29	125	88	13	\$846	
	bullnose edge	GCT5RBN	30 x 60 x 29	125	88	13	\$846	
	T-mold edge	GCT5RTM	30 x 60 x 29	125	88	13	\$846	
	built-up self edge	GCT5RBU	30 x 60 x 29	125	91	14	\$944	
6 foot	self edge	GCT6R	36 x 72 x 29	125	115	15	\$942	
	bullnose edge	GCT6RBN	36 x 72 x 29	92.5	152	15	\$942	
	T-mold edge	GCT6RTM	36 x 72 x 29	92.5	152	15	\$942	
	built-up self edge	GCT6RBU	36 x 72 x 29	92.5	162	16	\$1047	
7 foot	self edge	GCT7R	44 x 84 x 29	100	155	17	\$1088	
	bullnose edge	GCT7RBN	44 x 84 x 29	100	155	17	\$1088	
	T-mold edge	GCT7RTM	44 x 84 x 29	100	155	17	\$1088	
	built-up self edge	GCT7RBU	44 x 84 x 29	100	158	19.02	\$1220	
8 foot	self edge	GCT8WR	48 x 96 x 29	92.5	194	19.04	\$1088	
	bullnose edge	GCT8WRBN	48 x 96 x 29	100	180	19.02	\$1088	
	T-mold edge	GCT8WRTM	48 x 96 x 29	100	180	19.02	\$1088	
	built-up self edge	GCT8WRBU	48 x 96 x 29	92.5	211	21	\$1220	
10 foot	self edge	GCT10WR	48 x 120 x 29	92.5	214	20.93	\$1513	
	bullnose edge	GCT10WRBN	48 x 120 x 29	92.5	237	21	\$1513	
	T-mold edge	GCT10WRTM	48 x 120 x 29	92.5	237	21	\$1513	
	built-up self edge	GCT10WRBU	48 x 120 x 29	125	256	34.37	\$1693	
12 foot	self edge	GCT12WR	48 x 144 x 29	92.5	270	23	\$1701	
	bullnose edge	GCT12WRBN	48 x 144 x 29	85	270	21	\$1701	
	T-mold edge	GCT12WRTM	48 x 144 x 29	92.5	270	22.90	\$1701	
	built-up self edge	GCT12WRBU	48 x 144 x 29	85	309	24.91	\$1897	
14 foot	self edge	GCT14WR	48 x 168 x 29	100	326	34	\$1953	
	bullnose edge	GCT14WRBN	48 x 168 x 29	100	326	34	\$1953	
	T-mold edge	GCT14WRTM	48 x 168 x 29	100	326	34	\$1953	
	built-up self edge	GCT14WRBU	48 x 168 x 29	100	332	38	\$2159	
16 foot	self edge	GCT16WR	48 x 192 x 29	100	367	38	\$2041	
	bullnose edge	GCT16WRBN	48 x 192 x 29	100	367	38	\$2041	
	T-mold edge	GCT16WRTM	48 x 192 x 29	100	367	38	\$2041	
	built-up self edge	GCT16WRBU	48 x 192 x 29	100	373	40	\$2210	
18 foot	self edge	GCT18WR	48 x 216 x 29	92.5	408	40	\$2431	
	bullnose edge	GCT18WRBN	48 x 216 x 29	92.5	408	40	\$2431	
	T-mold edge	GCT18WRTM	48 x 216 x 29	92.5	408	40	\$2431	
	built-up self edge	GCT18WRBU	48 x 216 x 29	100	416	42	\$2712	
20 foot	self edge	GCT20WR	48 x 240 x 29	92.5	449	42	\$2517	
	bullnose edge	GCT20WRBN	48 x 240 x 29	92.5	449	42	\$2517	
	T-mold edge	GCT20WRTM	48 x 240 x 29	92.5	449	42	\$2517	
	built-up self edge	GCT20WRBU	48 x 240 x 29	92.5	457	44	\$2795	
22 foot	self edge	GCT22WR	48 x 264 x 29	92.5	489	44	\$2777	
	bullnose edge	GCT22WRBN	48 x 264 x 29	92.5	489	44	\$2777	
	T-mold edge	GCT22WRTM	48 x 264 x 29	92.5	489	44	\$2777	
	built-up self edge	GCT22WRBU	48 x 264 x 29	92.5	497	46	\$3126	
24 foot	self edge	GCT24WR	48 x 288 x 29	92.5	531	46	\$2862	
	bullnose edge	GCT24WRBN	48 x 288 x 29	92.5	531	46	\$2862	
	T-mold edge	GCT24WRTM	48 x 288 x 29	92.5	531	46	\$2862	
	built-up self edge	GCT24WRBU	48 x 288 x 29	92.5	540	48	\$3200	

- All tops over 144" are standard in two pieces. Woodgrain laminate finishes will NOT align where the two tops join.
- All tops 120", 144", and 168" are SHIPPED WITH 3 LEG BASES.
- All tops 192" are SHIPPED WITH 4 LEG BASES.
- All tops 216", 240", 264" and 288" are SHIPPED WITH 6 LEG BASES.

Required Specifications

Finish
Base Finish
Edge Color, if applicable

Optional Specifications

Grommet

Accessories

Power Block

B BOARDROOM TABLES

RECTANGULAR TOP - TUBULAR BASE

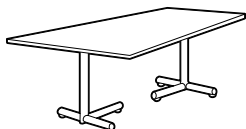

	MODEL#	DIMENSIONS	FREIGHT CLASS	WT./LBS.	CUBIC FT.	LIST PRICE	HP ADD
		D x W x H					
5 foot	self edge	GCR5R	30 x 60 x 29	150	94	21	\$872
	bullnose edge	GCR5RBN	30 x 60 x 29	150	94	21	\$872
	T-mold edge	GCR5RTM	30 x 60 x 29	150	94	21	\$872
	built-up self edge	GCR5RBU	30 x 60 x 29	150	97	23	\$974
6 foot	self edge	GCR6R	36 x 72 x 29	150	107	23	\$968
	bullnose edge	GCR6RBN	36 x 72 x 29	150	107	23	\$968
	T-mold edge	GCR6RTM	36 x 72 x 29	150	107	23	\$968
	built-up self edge	GCR6RBU	36 x 72 x 29	150	117	25	\$1078
7 foot	self edge	GCR7R	44 x 84 x 29	125	161	25	\$1116
	bullnose edge	GCR7RBN	44 x 84 x 29	125	161	25	\$1116
	T-mold edge	GCR7RTM	44 x 84 x 29	125	161	25	\$1116
	built-up self edge	GCR7RBU	44 x 84 x 29	125	164	27	\$1249
8 foot	self edge	GCR8WR	48 x 96 x 29	125	177	27	\$1116
	bullnose edge	GCR8WRBN	48 x 96 x 29	125	177	27	\$1116
	T-mold edge	GCR8WRTM	48 x 96 x 29	125	177	27	\$1116
	built-up self edge	GCR8WRBU	48 x 96 x 29	125	208	29	\$1249
10 foot	self edge	GCR10WR	48 x 120 x 29	125	221	28.92	\$1529
	bullnose edge	GCR10WRBN	48 x 120 x 29	125	221	28.92	\$1529
	T-mold edge	GCR10WRTM	48 x 120 x 29	125	221	29	\$1529
	built-up self edge	GCR10WRBU	48 x 120 x 29	125	239	32	\$1715
12 foot	self edge	GCR12WR	48 x 144 x 29	100	270	30.96	\$1722
	bullnose edge	GCR12WRBN	48 x 144 x 29	100	270	30.96	\$1722
	T-mold edge	GCR12WRTM	48 x 144 x 29	100	270	30.96	\$1722
	built-up self edge	GCR12WRBU	48 x 144 x 29	100	293	33.89	\$1922
14 foot	self edge	GCR14WR	48 x 168 x 29	125	330	50	\$1980
	bullnose edge	GCR14WRBN	48 x 168 x 29	125	330	50	\$1980
	T-mold edge	GCR14WRTM	48 x 168 x 29	125	330	50	\$1980
	built-up self edge	GCR14WRBU	48 x 168 x 29	125	336	54	\$2185
16 foot	self edge	GCR16WR	48 x 192 x 29	125	371	54	\$2066
	bullnose edge	GCR16WRBN	48 x 192 x 29	125	371	54	\$2066
	T-mold edge	GCR16WRTM	48 x 192 x 29	125	371	54	\$2066
	built-up self edge	GCR16WRBU	48 x 192 x 29	125	377	58	\$2268
18 foot	self edge	GCR18WR	48 x 216 x 29	125	412	56	\$2448
	bullnose edge	GCR18WRBN	48 x 216 x 29	125	412	56	\$2448
	T-mold edge	GCR18WRTM	48 x 216 x 29	125	412	56	\$2448
	built-up self edge	GCR18WRBU	48 x 216 x 29	125	419	60	\$2734
20 foot	self edge	GCR20WR	48 x 240 x 29	125	453	58	\$2534
	bullnose edge	GCR20WRBN	48 x 240 x 29	125	453	58	\$2534
	T-mold edge	GCR20WRTM	48 x 240 x 29	125	453	58	\$2534
	built-up self edge	GCR20WRBU	48 x 240 x 29	125	461	62	\$2826
22 foot	self edge	GCR22WR	48 x 264 x 29	100	493	60	\$2820
	bullnose edge	GCR22WRBN	48 x 264 x 29	100	493	60	\$2820
	T-mold edge	GCR22WRTM	48 x 264 x 29	100	493	60	\$2820
	built-up self edge	GCR22WRBU	48 x 264 x 29	125	501	64	\$3150
24 foot	self edge	GCR24WR	48 x 288 x 29	100	535	62	\$2909
	bullnose edge	GCR24WRBN	48 x 288 x 29	100	535	62	\$2909
	T-mold edge	GCR24WRTM	48 x 288 x 29	100	535	62	\$2909
	built-up self edge	GCR24WRBU	48 x 288 x 29	100	544	66	\$3233

- All tops over 144" are standard in two pieces. Woodgrain laminate finishes will NOT align where the two tops join.
- All tops 120", 144", and 168" are SHIPPED WITH 3 TUBULAR BASES.
- All tops 192" are SHIPPED WITH 4 TUBULAR BASES.
- All tops 216", 240", 264" and 288" are SHIPPED WITH 6 TUBULAR BASES.

Required Specifications

Finish
Base Finish
Edge Color, if applicable

Optional Specifications

Grommet

Accessories

Power Block

BOAT TOP - SLAB BASE

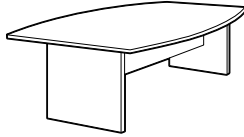

	MODEL#	DIMENSIONS	FREIGHT	CLASS	WT/LBS.	CUBIC FT.	LIST PRICE	HP ADD
	D x W x H							
5 foot	self edge	GCT5BX	30 x 60 x 29	70	131	6	\$718	
	bullnose edge	GCT5BXBN	30 x 60 x 29	70	131	6	\$718	
	T-mold edge	GCT5BXTM	30 x 60 x 29	70	131	7	\$718	
	built-up self edge	GCT5BXBU	30 x 60 x 29	125	114	17	\$794	
6 foot	self edge	GCT6BX	36 x 72 x 29	70	138	7.60	\$805	
	bullnose edge	GCT6BXBN	36 x 72 x 29	70	138	7.60	\$805	
	T-mold edge	GCT6BXTM	36 x 72 x 29	70	147	7.60	\$805	
	built-up self edge	GCT6BXBU	36 x 72 x 29	70	157	8.90	\$898	
7 foot	self edge	GCT7BX	44 x 84 x 29	70	199	9.94	\$1037	
	bullnose edge	GCT7BXBN	44 x 84 x 29	70	199	9.94	\$1037	
	T-mold edge	GCT7BXTM	44 x 84 x 29	70	199	9.94	\$1037	
	built-up self edge	GCT7BXBU	44 x 84 x 29	70	203	11.95	\$1170	
8 foot	self edge	GCT8WBX	48 x 96 x 29	70	218	11.29	\$1037	
	bullnose edge	GCT8WBXBN	48 x 96 x 29	70	218	11.29	\$1037	
	T-mold edge	GCT8WBXTM	48 x 96 x 29	70	218	11.29	\$1037	
	built-up self edge	GCT8WBXBU	48 x 96 x 29	70	218	13.53	\$1170	
10 foot	self edge	GCT10WBX2	48 x 120 x 29	70	249	13.53	\$1201	
	bullnose edge	GCT10WBX2BN	48 x 120 x 29	70	249	13.53	\$1201	
	T-mold edge	GCT10WBX2TM	48 x 120 x 29	70	249	13.53	\$1201	
	built-up self edge	GCT10WBX2BU	48 x 120 x 29	70	294	16.20	\$1422	
12 foot	self edge	GCT12WBX2	48 x 144 x 29	70	308	15.54	\$1411	
	bullnose edge	GCT12WBX2BN	48 x 144 x 29	70	308	15.54	\$1411	
	T-mold edge	GCT12WBX2TM	48 x 144 x 29	70	308	15.54	\$1411	
	built-up self edge	GCT12WBX2BU	48 x 144 x 29	70	338	18.83	\$1656	
14 foot	self edge	GCT14WBX2	48 x 168 x 29	65	419	18	\$2041	
	bullnose edge	GCT14WBX2BN	48 x 168 x 29	65	419	18	\$2041	
	T-mold edge	GCT14WBX2TM	48 x 168 x 29	65	419	18	\$2041	
	built-up self edge	GCT14WBX2BU	48 x 168 x 29	65	425	16	\$2278	
16 foot	self edge	GCT16WBX2	48 x 192 x 29	70	460	22.70	\$2127	
	bullnose edge	GCT16WBX2BN	48 x 192 x 29	70	460	22.70	\$2127	
	T-mold edge	GCT16WBX2TM	48 x 192 x 29	70	460	22.70	\$2127	
	built-up self edge	GCT16WBX2BU	48 x 192 x 29	70	466	27.20	\$2375	
18 foot	self edge	GCT18WBX2	48 x 216 x 29	70	521	24.60	\$2647	
	bullnose edge	GCT18WBX2BN	48 x 216 x 29	70	521	24.60	\$2647	
	T-mold edge	GCT18WBX2TM	48 x 216 x 29	70	521	24.60	\$2647	
	built-up self edge	GCT18WBX2BU	48 x 216 x 29	70	528	29.80	\$2967	
20 foot	self edge	GCT20WBX2	48 x 240 x 29	70	572	26.60	\$2689	
	bullnose edge	GCT20WBX2BN	48 x 240 x 29	70	572	26.60	\$2689	
	T-mold edge	GCT20WBX2TM	48 x 240 x 29	70	572	26.60	\$2689	
	built-up self edge	GCT20WBX2BU	48 x 240 x 29	70	580	32.50	\$3011	
22 foot	self edge	GCT22WBX2	48 x 264 x 29	70	612	28.90	\$3122	
	bullnose edge	GCT22WBX2BN	48 x 264 x 29	70	612	28.90	\$3122	
	T-mold edge	GCT22WBX2TM	48 x 264 x 29	70	612	28.90	\$3122	
	built-up self edge	GCT22WBX2BU	48 x 264 x 29	70	620	35.10	\$3448	
24 foot	self edge	GCT24WBX2	48 x 288 x 29	70	673	31.20	\$3210	
	bullnose edge	GCT24WBX2BN	48 x 288 x 29	70	673	31.20	\$3210	
	T-mold edge	GCT24WBX2TM	48 x 288 x 29	70	673	31.20	\$3210	
	built-up self edge	GCT24WBX2BU	48 x 288 x 29	70	682	37.70	\$3551	

- All tops over 144" are standard in two pieces. Woodgrain laminate finishes will NOT align where the two tops join.
- All tops 168", 192", 216" and 240" are SHIPPED WITH 3 SLAB BASES.
- All tops 264" and 288" are SHIPPED WITH 4 SLAB BASES.

Required Specifications

Finish
Base Finish
Edge Color, if applicable

Optional Specifications

Grommet

Accessories

Power Block

B BOARDROOM TABLES

BOAT TOP - DRUM BASE

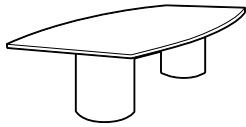

	MODEL#	DIMENSIONS	FREIGHT CLASS	WT./LBS.	CUBIC FT.	LIST PRICE	HP ADD
		D x W x H					
6 foot	self edge	GCT6BZ	36 x 72 x 29	100	162	17.50	\$1088
	bullnose edge	GCT6BZBN	36 x 72 x 29	100	153	17.50	\$1088
	T-mold edge	GCT6BZTM	36 x 72 x 29	100	162	17.50	\$1088
	built-up self edge	GCT6BZBU	36 x 72 x 29	100	172	18.90	\$1218
7 foot	self edge	GCT7BZ	44 x 84 x 29	92.5	196	19.40	\$1236
	bullnose edge	GCT7BZBN	44 x 84 x 29	92.5	196	19.40	\$1236
	T-mold edge	GCT7BZTM	44 x 84 x 29	92.5	196	19.40	\$1236
	built-up self edge	GCT7BZBU	44 x 84 x 29	100	199	21.20	\$1390
8 foot	self edge	GCT8WBZ	48 x 96 x 29	92.5	219	21.20	\$1261
	bullnose edge	GCT8WBZBN	48 x 96 x 29	92.5	219	21.20	\$1261
	T-mold edge	GCT8WBZTM	48 x 96 x 29	92.5	219	21.20	\$1261
	built-up self edge	GCT8WBZBU	48 x 96 x 29	92.5	250	23.50	\$1390
10 foot	self edge	GCT10WBZ2	48 x 120 x 29	100	272	33.30	\$1478
	bullnose edge	GCT10WBZ2BN	48 x 120 x 29	100	272	33.30	\$1478
	T-mold edge	GCT10WBZ2TM	48 x 120 x 29	100	272	33.22	\$1478
	built-up self edge	GCT10WBZ2BU	48 x 120 x 29	100	317	35.70	\$1630
12 foot	self edge	GCT12WBZ2	48 x 144 x 29	100	327	35.30	\$1652
	bullnose edge	GCT12WBZ2BN	48 x 144 x 29	100	327	35.30	\$1652
	T-mold edge	GCT12WBZ2TM	48 x 144 x 29	100	327	35.30	\$1652
	built-up self edge	GCT12WBZ2BU	48 x 144 x 29	100	357	38.40	\$1834
14 foot	self edge	GCT14WBZ2	48 x 168 x 29	92.5	441	39	\$2215
	bullnose edge	GCT14WBZ2BN	48 x 168 x 29	92.5	441	39	\$2215
	T-mold edge	GCT14WBZ2TM	48 x 168 x 29	92.5	441	39	\$2215
	built-up self edge	GCT14WBZ2BU	48 x 168 x 29	92.5	447	42	\$2456
16 foot	self edge	GCT16WBZ2	48 x 192 x 29	92.5	482	42.52	\$2301
	bullnose edge	GCT16WBZ2BN	48 x 192 x 29	92.5	482	42.52	\$2301
	T-mold edge	GCT16WBZ2TM	48 x 192 x 29	92.5	482	42.52	\$2301
	built-up self edge	GCT16WBZ2BU	48 x 192 x 29	92.5	488	47	\$2540
18 foot	self edge	GCT18WBZ2	48 x 216 x 29	100	523	54.40	\$2994
	bullnose edge	GCT18WBZ2BN	48 x 216 x 29	100	523	54.40	\$2994
	T-mold edge	GCT18WBZ2TM	48 x 216 x 29	100	523	54.40	\$2994
	built-up self edge	GCT18WBZ2BU	48 x 216 x 29	100	550	59	\$3365
20 foot	self edge	GCT20WBZ2	48 x 240 x 29	100	564	66.20	\$3037
	bullnose edge	GCT20WBZ2BN	48 x 240 x 29	100	564	66.20	\$3037
	T-mold edge	GCT20WBZ2TM	48 x 240 x 29	100	564	66.20	\$3037
	built-up self edge	GCT20WBZ2BU	48 x 240 x 29	100	572	70.60	\$3410
22 foot	self edge	GCT22WBZ2	48 x 264 x 29	100	604	68.20	\$3383
	bullnose edge	GCT22WBZ2BN	48 x 264 x 29	100	604	68.20	\$3383
	T-mold edge	GCT22WBZ2TM	48 x 264 x 29	100	604	68.20	\$3383
	built-up self edge	GCT22WBZ2BU	48 x 264 x 29	100	612	73.68	\$3779
24 foot	self edge	GCT24WBZ2	48 x 288 x 29	100	646	70.20	\$3470
	bullnose edge	GCT24WBZ2BN	48 x 288 x 29	100	646	70.20	\$3470
	T-mold edge	GCT24WBZ2TM	48 x 288 x 29	100	646	70.20	\$3470
	built-up self edge	GCT24WBZ2BU	48 x 288 x 29	100	655	76.80	\$3861

- All Drum Bases require approx. 125 lb. of sand in each base for adequate stability. Sand is not included.
- All tops over 144" are standard in two pieces. Woodgrain laminate finishes will NOT align where the two tops join.
- All tops 168", 192" and 216" are SHIPPED WITH 3 DRUM BASES.
- All tops 240", 264" and 288" are SHIPPED WITH 4 DRUM BASES.

Required Specifications

Finish
Base Finish
Edge Color, if applicable

Optional Specifications

Grommet

Accessories

Power Block

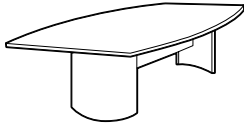
BOAT TOP - ARCH BASE

		MODEL#	DIMENSIONS	FREIGHT	CLASS	WT/LBS.	CUBIC FT.	LIST PRICE	HP ADD
		D x W x H							
5 foot	self edge	GCT5BA	30 x 60 x 29	85	131	9		\$958	
	bullnose edge	GCT5BABN	30 x 60 x 29	85	131	9		\$958	
	T-mold edge	GCT5BATM	30 x 60 x 29	85	131	9		\$958	
	built-up self edge	GCT5BABU	30 x 60 x 29	85	134	10		\$1087	
6 foot	self edge	GCT6BA	36 x 72 x 29	85	152	11		\$1001	
	bullnose edge	GCT6BABN	36 x 72 x 29	85	152	11		\$1001	
	T-mold edge	GCT6BATM	36 x 72 x 29	85	152	11		\$1001	
	built-up self edge	GCT6BABU	36 x 72 x 29	85	162	12		\$1190	
7 foot	self edge	GCT7BA	44 x 84 x 29	70	203	12.96		\$1219	
	bullnose edge	GCT7BABN	44 x 84 x 29	70	203	12.96		\$1219	
	T-mold edge	GCT7BATM	44 x 84 x 29	70	203	12.96		\$1219	
	built-up self edge	GCT7BABU	44 x 84 x 29	85	206	13.98		\$1382	
8 foot	self edge	GCT8WBA	48 x 96 x 29	70	228	14.97		\$1219	
	bullnose edge	GCT8WBABN	48 x 96 x 29	85	220	14.97		\$1219	
	T-mold edge	GCT8WBATM	48 x 96 x 29	85	220	14.97		\$1219	
	built-up self edge	GCT8WBABU	48 x 96 x 29	85	220	15.96		\$1382	
10 foot	self edge	GCT10WBA	48 x 120 x 29	85	251	16.95		\$1391	
	bullnose edge	GCT10WBABN	48 x 120 x 29	85	251	16.95		\$1391	
	T-mold edge	GCT10WBATM	48 x 120 x 29	85	251	16.95		\$1391	
	built-up self edge	GCT10WBABU	48 x 120 x 29	70	296	18.92		\$1640	
12 foot	self edge	GCT12WBA	48 x 144 x 29	70	306	20		\$1608	
	bullnose edge	GCT12WBABN	48 x 144 x 29	70	310	19.94		\$1608	
	T-mold edge	GCT12WBATM	48 x 144 x 29	70	310	19.94		\$1608	
	built-up self edge	GCT12WBABU	48 x 144 x 29	70	340	21.89		\$1878	
14 foot	self edge	GCT14WBA	48 x 168 x 29	70	423	25.93		\$2476	
	bullnose edge	GCT14WBABN	48 x 168 x 29	70	423	25.93		\$2476	
	T-mold edge	GCT14WBATM	48 x 168 x 29	70	423	25.93		\$2476	
	built-up self edge	GCT14WBABU	48 x 168 x 29	70	429	27.90		\$2759	
16 foot	self edge	GCT16WBA	48 x 192 x 29	70	474	29.94		\$2604	
	bullnose edge	GCT16WBABN	48 x 192 x 29	70	474	29.94		\$2604	
	T-mold edge	GCT16WBATM	48 x 192 x 29	70	474	29.94		\$2604	
	built-up self edge	GCT16WBABU	48 x 192 x 29	70	480	31.92		\$2912	
18 foot	self edge	GCT18WBA	48 x 216 x 29	70	525	31.92		\$3210	
	bullnose edge	GCT18WBABN	48 x 216 x 29	70	525	31.92		\$3210	
	T-mold edge	GCT18WBATM	48 x 216 x 29	70	525	31.92		\$3210	
	built-up self edge	GCT18WBABU	48 x 216 x 29	70	532	33.89		\$3586	
20 foot	self edge	GCT20WBA	48 x 240 x 29	70	576	33.89		\$3256	
	bullnose edge	GCT20WBABN	48 x 240 x 29	70	576	33.89		\$3256	
	T-mold edge	GCT20WBATM	48 x 240 x 29	70	576	33.89		\$3256	
	built-up self edge	GCT20WBABU	48 x 240 x 29	70	584	35.93		\$3621	
22 foot	self edge	GCT22WBA	48 x 264 x 29	70	626	36.89		\$3640	
	bullnose edge	GCT22WBABN	48 x 264 x 29	70	626	36.89		\$3640	
	T-mold edge	GCT22WBATM	48 x 264 x 29	70	626	36.89		\$3640	
	built-up self edge	GCT22WBABU	48 x 264 x 29	70	634	37.90		\$4070	
24 foot	self edge	GCT24WBA	48 x 288 x 29	70	678	40		\$3728	
	bullnose edge	GCT24WBABN	48 x 288 x 29	70	678	40		\$3728	
	T-mold edge	GCT24WBATM	48 x 288 x 29	70	678	40		\$3728	
	built-up self edge	GCT24WBABU	48 x 288 x 29	65	687	25.10		\$4153	

- All tops over 144" are standard in two pieces. Woodgrain laminate finishes will NOT align where the two tops join.
- All tops 168", 192", 216" and 240" are SHIPPED WITH 2 ARCH BASES AND 1 SLAB BASE.
- All tops 264" and 288" are SHIPPED WITH 2 ARCH BASES AND 2 SLAB BASES.

Required Specifications

Finish
Base Finish
Edge Color, if applicable

Optional Specifications

Grommet

Accessories

Power Block

B BOARDROOM TABLES

BOAT TOP - 2 LEG BASE



	MODEL#	DIMENSIONS	FREIGHT CLASS	WT/LBS.	CUBIC FT.	LIST PRICE	HP ADD
		D x W x H					
5 foot	self edge	GCT5B	30 x 60 x 29	125	88	13	\$846
	bullnose edge	GCT5BBN	30 x 60 x 29	125	88	13	\$846
	T-mold edge	GCT5BTM	30 x 60 x 29	125	88	13	\$846
	built-up self edge	GCT5BBU	30 x 60 x 29	125	91	14	\$944
6 foot	self edge	GCT6B	36 x 72 x 29	100	123	15	\$942
	bullnose edge	GCT6BBN	36 x 72 x 29	125	114	15	\$942
	T-mold edge	GCT6BTM	36 x 72 x 29	100	123	15	\$942
	built-up self edge	GCT6BBU	36 x 72 x 29	100	133	16	\$1047
7 foot	self edge	GCT7B	44 x 84 x 29	100	155	16.98	\$1088
	bullnose edge	GCT7BBN	44 x 84 x 29	100	155	16.98	\$1088
	T-mold edge	GCT7BTM	44 x 84 x 29	100	155	16.98	\$1088
	built-up self edge	GCT7BBU	44 x 84 x 29	100	158	18.98	\$1220
8 foot	self edge	GCT8WB	48 x 96 x 29	100	188	19	\$1088
	bullnose edge	GCT8WBBN	48 x 96 x 29	100	180	19	\$1088
	T-mold edge	GCT8WBTM	48 x 96 x 29	100	180	18.98	\$1088
	built-up self edge	GCT8WBBU	48 x 96 x 29	100	180	21	\$1220
10 foot	self edge	GCT10WB	48 x 120 x 29	92.5	214	21	\$1513
	bullnose edge	GCT10WBBN	48 x 120 x 29	92.5	214	20.98	\$1513
	T-mold edge	GCT10WBTM	48 x 120 x 29	92.5	214	20.93	\$1513
	built-up self edge	GCT10WBBU	48 x 120 x 29	92.5	259	22.93	\$1693
12 foot	self edge	GCT12WB	48 x 144 x 29	92.5	265	22.80	\$1701
	bullnose edge	GCT12WBBN	48 x 144 x 29	92.5	269	22.69	\$1701
	T-mold edge	GCT12WBTM	48 x 144 x 29	92.5	269	22.69	\$1701
	built-up self edge	GCT12WBBU	48 x 144 x 29	92.5	299	25.69	\$1898
14 foot	self edge	GCT14WB	48 x 168 x 29	100	326	34	\$1953
	bullnose edge	GCT14WBBN	48 x 168 x 29	100	326	34	\$1953
	T-mold edge	GCT14WBTM	48 x 168 x 29	100	326	34	\$1953
	built-up self edge	GCT14WBBU	48 x 168 x 29	100	332	38	\$2159
16 foot	self edge	GCT16WB	48 x 192 x 29	100	367	38	\$2041
	bullnose edge	GCT16WBBN	48 x 192 x 29	100	367	38	\$2041
	T-mold edge	GCT16WBTM	48 x 192 x 29	100	367	38	\$2041
	built-up self edge	GCT16WBBU	48 x 192 x 29	100	373	40	\$2210
18 foot	self edge	GCT18WB	48 x 216 x 29	92.5	408	40	\$2431
	bullnose edge	GCT18WBBN	48 x 216 x 29	92.5	408	40	\$2431
	T-mold edge	GCT18WBTM	48 x 216 x 29	92.5	408	40	\$2431
	built-up self edge	GCT18WBBU	48 x 216 x 29	100	416	42	\$2712
20 foot	self edge	GCT20WB	48 x 240 x 29	92.5	449	42	\$2517
	bullnose edge	GCT20WBBN	48 x 240 x 29	92.5	449	42	\$2517
	T-mold edge	GCT20WBTM	48 x 240 x 29	92.5	449	42	\$2517
	built-up self edge	GCT20WBBU	48 x 240 x 29	92.5	457	44	\$2795
22 foot	self edge	GCT22WB	48 x 264 x 29	92.5	489	44	\$2777
	bullnose edge	GCT22WBBN	48 x 264 x 29	92.5	489	44	\$2777
	T-mold edge	GCT22WBTM	48 x 264 x 29	92.5	489	44	\$2777
	built-up self edge	GCT22WBBU	48 x 264 x 29	92.5	497	46	\$3126
24 foot	self edge	GCT24WB	48 x 288 x 29	92.5	531	46	\$2862
	bullnose edge	GCT24WBBN	48 x 288 x 29	92.5	531	46	\$2862
	T-mold edge	GCT24WBTM	48 x 288 x 29	92.5	531	46	\$2862
	built-up self edge	GCT24WBBU	48 x 288 x 29	92.5	540	48	\$3200

- All tops over 144" are standard in two pieces. Woodgrain laminate finishes will NOT align where the two tops join.
- All tops 120", 144", and 168" are SHIPPED WITH 3 LEG BASES.
- All tops 192" are SHIPPED WITH 4 LEG BASES.
- All tops 216", 240", 264" and 288" are SHIPPED WITH 6 LEG BASES.

Required Specifications

Finish
Base Finish
Edge Color, if applicable

Optional Specifications

Grommet

Accessories

Power Block

BOAT TOP - TUBULAR BASE



	MODEL#	DIMENSIONS	FREIGHT CLASS	WT/LBS.	CUBIC FT.	LIST PRICE	HP ADD
	D x W x H						
5 foot	self edge	GCR5B	30 x 60 x 29	150	94	21	\$872
	bullnose edge	GCR5BBN	30 x 60 x 29	150	94	21	\$872
	T-mold edge	GCR5BTM	30 x 60 x 29	150	94	21	\$872
	built-up self edge	GCR5BBU	30 x 60 x 29	150	97	23	\$974
6 foot	self edge	GCR6B	36 x 72 x 29	150	107	23	\$968
	bullnose edge	GCR6BBN	36 x 72 x 29	150	107	23	\$968
	T-mold edge	GCR6BTM	36 x 72 x 29	150	107	23	\$968
	built-up self edge	GCR6BBU	36 x 72 x 29	150	117	25	\$1078
7 foot	self edge	GCR7B	44 x 84 x 29	125	161	25	\$1116
	bullnose edge	GCR7BBN	44 x 84 x 29	125	161	25	\$1116
	T-mold edge	GCR7BTM	44 x 84 x 29	125	161	25	\$1116
	built-up self edge	GCR7BBU	44 x 84 x 29	150	164	29	\$1249
8 foot	self edge	GCR8WB	48 x 96 x 29	125	184	27	\$1116
	bullnose edge	GCR8WBBN	48 x 96 x 29	125	177	27	\$1116
	T-mold edge	GCR8WBTM	48 x 96 x 29	125	177	27	\$1116
	built-up self edge	GCR8WBBU	48 x 96 x 29	125	208	29	\$1249
10 foot	self edge	GCR10WB	48 x 120 x 29	125	221	29	\$1529
	bullnose edge	GCR10WBBN	48 x 120 x 29	125	221	29	\$1529
	T-mold edge	GCR10WBTM	48 x 120 x 29	125	221	29	\$1529
	built-up self edge	GCR10WBBU	48 x 120 x 29	125	239	32	\$1715
12 foot	self edge	GCR12WB	48 x 144 x 29	100	270	31	\$1722
	bullnose edge	GCR12WBBN	48 x 144 x 29	100	270	31	\$1722
	T-mold edge	GCR12WBTM	48 x 144 x 29	100	270	30.78	\$1722
	built-up self edge	GCR12WBBU	48 x 144 x 29	100	293	34	\$1922
14 foot	self edge	GCR14WB	48 x 168 x 29	125	330	50	\$1980
	bullnose edge	GCR14WBBN	48 x 168 x 29	125	330	50	\$1980
	T-mold edge	GCR14WBTM	48 x 168 x 29	125	330	50	\$1980
	built-up self edge	GCR14WBBU	48 x 168 x 29	125	336	54	\$2185
16 foot	self edge	GCR16WB	48 x 192 x 29	125	371	54	\$2066
	bullnose edge	GCR16WBBN	48 x 192 x 29	125	371	54	\$2066
	T-mold edge	GCR16WBTM	48 x 192 x 29	125	371	54	\$2066
	built-up self edge	GCR16WBBU	48 x 192 x 29	125	377	58	\$2268
18 foot	self edge	GCR18WB	48 x 216 x 29	125	412	56	\$2448
	bullnose edge	GCR18WBBN	48 x 216 x 29	125	412	56	\$2448
	T-mold edge	GCR18WBTM	48 x 216 x 29	125	412	56	\$2448
	built-up self edge	GCR18WBBU	48 x 216 x 29	125	419	60	\$2734
20 foot	self edge	GCR20WB	48 x 240 x 29	125	453	58	\$2534
	bullnose edge	GCR20WBBN	48 x 240 x 29	125	453	58	\$2534
	T-mold edge	GCR20WBTM	48 x 240 x 29	125	453	58	\$2534
	built-up self edge	GCR20WBBU	48 x 240 x 29	125	461	62	\$2826
22 foot	self edge	GCR22WB	48 x 264 x 29	100	493	60	\$2820
	bullnose edge	GCR22WBBN	48 x 264 x 29	100	493	60	\$2820
	T-mold edge	GCR22WBTM	48 x 264 x 29	100	493	60	\$2820
	built-up self edge	GCR22WBBU	48 x 264 x 29	125	501	64	\$3150
24 foot	self edge	GCR24WB	48 x 288 x 29	100	535	62	\$2909
	bullnose edge	GCR24WBBN	48 x 288 x 29	100	535	62	\$2909
	T-mold edge	GCR24WBTM	48 x 288 x 29	100	535	62	\$2909
	built-up self edge	GCR24WBBU	48 x 288 x 29	100	544	66	\$3233

- All tops over 144" are standard in two pieces. Woodgrain laminate finishes will NOT align where the two tops join.
- All tops 120", 144", and 168" are SHIPPED WITH 3 TUBULAR BASES.
- All tops 192" are SHIPPED WITH 4 TUBULAR BASES.
- All tops 216", 240", 264" and 288" are SHIPPED WITH 6 TUBULAR BASES.

Required Specifications

Finish
Base Finish
Edge Color, if applicable

Optional Specifications

Grommet

Accessories

Power Block

B BOARDROOM TABLES

RACETRACK TOP - SLAB BASE

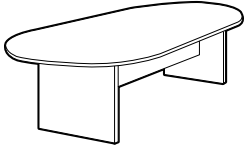

	MODEL#	DIMENSIONS	FREIGHT CLASS	WT/LBS.	CUBIC FT.	LIST PRICE	HP ADD
		D x W x H					
5 foot	self edge	GRT5X	30 x 60 x 29	70	131	6	\$718
	bullnose edge	GRT5XBN	30 x 60 x 29	70	131	6	\$718
	T-mold edge	GRT5XTM	30 x 60 x 29	70	131	6	\$718
	built-up self edge	GRT5XBU	30 x 60 x 29	70	134	7	\$794
6 foot	self edge	GRT6X	36 x 72 x 29	70	135	7.60	\$805
	bullnose edge	GRT6XBN	36 x 72 x 29	70	143	7.60	\$805
	T-mold edge	GRT6XTM	36 x 72 x 29	70	143	7.60	\$805
	built-up self edge	GRT6XBU	36 x 72 x 29	70	160	8.90	\$898
7 foot	self edge	GRT7X	44 x 84 x 29	70	199	9.94	\$1037
	bullnose edge	GRT7XBN	44 x 84 x 29	70	199	9.97	\$1037
	T-mold edge	GRT7XTM	44 x 84 x 29	70	199	9.94	\$1037
	built-up self edge	GRT7XBU	44 x 84 x 29	70	203	11.95	\$1170
8 foot	self edge	GRT8WX	48 x 96 x 29	70	216	11.29	\$1037
	bullnose edge	GRT8WXBN	48 x 96 x 29	70	218	11.29	\$1037
	T-mold edge	GRT8WXTM	48 x 96 x 29	70	216	11.29	\$1037
	built-up self edge	GRT8WXBU	48 x 96 x 29	70	242	13.53	\$1170
10 foot	self edge	GRT10WX2	48 x 120 x 29	70	280	13.53	\$1201
	bullnose edge	GRT10WX2BN	48 x 120 x 29	70	266	13.53	\$1201
	T-mold edge	GRT10WX2TM	48 x 120 x 29	70	256	13.53	\$1201
	built-up self edge	GRT10WX2BU	48 x 120 x 29	70	289	16.20	\$1422
12 foot	self edge	GRT12WX2	48 x 144 x 29	70	210	12.54	\$1411
	bullnose edge	GRT12WX2BN	48 x 144 x 29	65	307	12.54	\$1411
	T-mold edge	GRT12WX2TM	48 x 144 x 29	65	307	12.54	\$1411
	built-up self edge	GRT12WX2BU	48 x 144 x 29	70	340	18.83	\$1656
14 foot	self edge	GRT14WX2	48 x 168 x 29	65	419	18	\$2041
	bullnose edge	GRT14WX2BN	48 x 168 x 29	65	419	18	\$2041
	T-mold edge	GRT14WX2TM	48 x 168 x 29	65	419	18	\$2041
	built-up self edge	GRT14WX2BU	48 x 168 x 29	70	425	20	\$2278
16 foot	self edge	GRT16WX2	48 x 192 x 29	70	460	22.70	\$2127
	bullnose edge	GRT16WX2BN	48 x 192 x 29	70	460	22.70	\$2127
	T-mold edge	GRT16WX2TM	48 x 192 x 29	70	460	22.70	\$2127
	built-up self edge	GRT16WX2BU	48 x 192 x 29	70	466	27.20	\$2375
18 foot	self edge	GRT18WX2	48 x 216 x 29	70	521	24.60	\$2647
	bullnose edge	GRT18WX2BN	48 x 216 x 29	70	521	24.60	\$2647
	T-mold edge	GRT18WX2TM	48 x 216 x 29	70	521	24.60	\$2647
	built-up self edge	GRT18WX2BU	48 x 216 x 29	70	528	29.80	\$2967
20 foot	self edge	GRT20WX2	48 x 240 x 29	70	572	26.60	\$2689
	bullnose edge	GRT20WX2BN	48 x 240 x 29	70	572	26.60	\$2689
	T-mold edge	GRT20WX2TM	48 x 240 x 29	70	572	26.60	\$2689
	built-up self edge	GRT20WX2BU	48 x 240 x 29	70	580	32.50	\$3011
22 foot	self edge	GRT22WX2	48 x 264 x 29	70	612	28.90	\$3122
	bullnose edge	GRT22WX2BN	48 x 264 x 29	70	612	28.90	\$3122
	T-mold edge	GRT22WX2TM	48 x 264 x 29	70	612	28.90	\$3122
	built-up self edge	GRT22WX2BU	48 x 264 x 29	70	620	35.10	\$3448
24 foot	self edge	GRT24WX2	48 x 288 x 29	70	673	31.20	\$3210
	bullnose edge	GRT24WX2BN	48 x 288 x 29	70	673	31.20	\$3210
	T-mold edge	GRT24WX2TM	48 x 288 x 29	70	673	31.20	\$3210
	built-up self edge	GRT24WX2BU	48 x 288 x 29	70	682	37.70	\$3551

- All tops over 144" are standard in two pieces. Woodgrain laminate finishes will NOT align where the two tops join.
- All tops 168", 192", 216" and 240" are SHIPPED WITH 3 SLAB BASES.
- All tops 264" and 288" are SHIPPED WITH 4 SLAB BASES.

Required Specifications

Finish
Base Finish
Edge Color, if applicable

Optional Specifications

Grommet

Accessories

Power Block

RACETRACK TOP - DRUM BASE

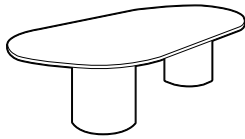

		MODEL#	DIMENSIONS	FREIGHT	CLASS	WT/LBS.	CUBIC FT.	LIST PRICE	HP ADD
		D x W x H							
6 foot	self edge	GRT6Z	36 x 72 x 29	100	150	17.50	\$1088		
	bullnose edge	GRT6ZBN	36 x 72 x 29	100	158	17.50	\$1088		
	T-mold edge	GRT6ZTM	36 x 72 x 29	100	158	17.50	\$1088		
	built-up self edge	GRT6ZBU	36 x 72 x 29	100	175	18.80	\$1218		
7 foot	self edge	GRT7Z	44 x 84 x 29	92.5	196	19.40	\$1261		
	bullnose edge	GRT7ZBN	44 x 84 x 29	92.5	196	19.40	\$1261		
	T-mold edge	GRT7ZTM	44 x 84 x 29	92.5	196	19.40	\$1261		
	built-up self edge	GRT7ZBU	44 x 84 x 29	100	199	21.20	\$1390		
8 foot	self edge	GRT8WZ	48 x 96 x 29	92.5	217	21.26	\$1261		
	bullnose edge	GRT8WZBN	48 x 96 x 29	92.5	219	21.26	\$1261		
	T-mold edge	GRT8WZTM	48 x 96 x 29	92.5	217	21.26	\$1261		
	built-up self edge	GRT8WZBU	48 x 96 x 29	92.5	243	23.50	\$1390		
10 foot	self edge	GRT10WZ2	48 x 120 x 29	100	313	33.14	\$1478		
	bullnose edge	GRT10WZ2BN	48 x 120 x 29	100	289	33.14	\$1478		
	T-mold edge	GRT10WZ2TM	48 x 120 x 29	100	279	33.14	\$1478		
	built-up self edge	GRT10WZ2BU	48 x 120 x 29	100	312	35.70	\$1630		
12 foot	self edge	GRT12WZ2	48 x 144 x 29	100	329	35.14	\$1652		
	bullnose edge	GRT12WZ2BN	48 x 144 x 29	150	326	58.70	\$1652		
	T-mold edge	GRT12WZ2TM	48 x 144 x 29	100	326	35.14	\$1652		
	built-up self edge	GRT12WZ2BU	48 x 144 x 29	100	359	38.32	\$1834		
14 foot	self edge	GRT14WZ2	48 x 168 x 29	92.5	478	44.44	\$2215		
	bullnose edge	GRT14WZ2BN	48 x 168 x 29	92.5	441	39	\$2215		
	T-mold edge	GRT14WZ2TM	48 x 168 x 29	92.5	441	39	\$2215		
	built-up self edge	GRT14WZ2BU	48 x 168 x 29	92.5	447	42	\$2456		
16 foot	self edge	GRT16WZ2	48 x 192 x 29	92.5	478	42.50	\$2301		
	bullnose edge	GRT16WZ2BN	48 x 192 x 29	92.5	482	42.50	\$2301		
	T-mold edge	GRT16WZ2TM	48 x 192 x 29	92.5	482	42.50	\$2301		
	built-up self edge	GRT16WZ2BU	48 x 192 x 29	92.5	488	47	\$2540		
18 foot	self edge	GRT18WZ2	48 x 216 x 29	100	523	54.40	\$2994		
	bullnose edge	GRT18WZ2BN	48 x 216 x 29	100	523	54	\$2994		
	T-mold edge	GRT18WZ2TM	48 x 216 x 29	100	523	54.40	\$2994		
	built-up self edge	GRT18WZ2BU	48 x 216 x 29	100	550	59	\$3365		
20 foot	self edge	GRT20WZ2	48 x 240 x 29	100	564	66.20	\$3037		
	bullnose edge	GRT20WZ2BN	48 x 240 x 29	100	564	66.20	\$3037		
	T-mold edge	GRT20WZ2TM	48 x 240 x 29	100	564	66.20	\$3037		
	built-up self edge	GRT20WZ2BU	48 x 240 x 29	100	572	70.60	\$3410		
22 foot	self edge	GRT22WZ2	48 x 264 x 29	100	604	68.20	\$3383		
	bullnose edge	GRT22WZ2BN	48 x 264 x 29	100	604	68.20	\$3383		
	T-mold edge	GRT22WZ2TM	48 x 264 x 29	100	604	68.20	\$3383		
	built-up self edge	GRT22WZ2BU	48 x 264 x 29	100	612	73.70	\$3779		
24 foot	self edge	GRT24WZ2	48 x 288 x 29	100	646	70.20	\$3470		
	bullnose edge	GRT24WZ2BN	48 x 288 x 29	100	646	70.20	\$3470		
	T-mold edge	GRT24WZ2TM	48 x 288 x 29	100	646	70.20	\$3470		
	built-up self edge	GRT24WZ2BU	48 x 288 x 29	100	655	76.80	\$3861		

- All Drum Bases require approx. 125 lb. of sand in each base for adequate stability. Sand is not included.
- All tops over 144" are standard in two pieces. Woodgrain laminate finishes will NOT align where the two tops join.
- All tops 168", 192" and 216" are SHIPPED WITH 3 DRUM BASES.
- All tops 240", 264" and 288" are SHIPPED WITH 4 DRUM BASES.

Required Specifications

Finish
Base Finish
Edge Color, if applicable

Optional Specifications

Grommet

Accessories

Power Block

B BOARDROOM TABLES

RACETRACK TOP - ARCH BASE

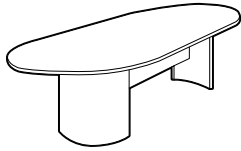

	MODEL#	DIMENSIONS D x W x H	FREIGHT CLASS	WT./LBS.	CUBIC FT.	LIST PRICE	HP ADD
5 foot	self edge	GRT5A	30 x 60 x 29	85	131	9	\$958
	bullnose edge	GRT5ABN	30 x 60 x 29	85	131	9	\$958
	T-mold edge	GRT5ATM	30 x 60 x 29	85	131	9	\$958
	built-up self edge	GRT5ABU	30 x 60 x 29	85	134	10	\$1087
6 foot	self edge	GRT6A	36 x 72 x 29	85	140	11	\$1001
	bullnose edge	GRT6ABN	36 x 72 x 29	85	148	11	\$1001
	T-mold edge	GRT6ATM	36 x 72 x 29	85	148	11	\$1001
	built-up self edge	GRT6ABU	36 x 72 x 29	85	165	12	\$1190
7 foot	self edge	GRT7A	44 x 84 x 29	70	203	12.93	\$1219
	bullnose edge	GRT7ABN	44 x 84 x 29	70	203	12.93	\$1219
	T-mold edge	GRT7ATM	44 x 84 x 29	70	203	12.93	\$1219
	built-up self edge	GRT7ABU	44 x 84 x 29	85	206	13.95	\$1382
8 foot	self edge	GRT8WA	48 x 96 x 29	85	218	14.94	\$1219
	bullnose edge	GRT8WABN	48 x 96 x 29	92.5	236	22.40	\$1219
	T-mold edge	GRT8WATM	48 x 96 x 29	85	218	14.94	\$1219
	built-up self edge	GRT8WABU	48 x 96 x 29	70	244	15.93	\$1382
10 foot	self edge	GRT10WA	48 x 120 x 29	70	268	16.95	\$1391
	bullnose edge	GRT10WABN	48 x 120 x 29	70	268	16.95	\$1391
	T-mold edge	GRT10WATM	48 x 120 x 29	70	268	16.95	\$1391
	built-up self edge	GRT10WABU	48 x 120 x 29	70	291	18.92	\$1640
12 foot	self edge	GRT12WA	48 x 144 x 29	85	309	24.94	\$1608
	bullnose edge	GRT12WABN	48 x 144 x 29	65	309	11.98	\$1608
	T-mold edge	GRT12WATM	48 x 144 x 29	100	309	33.29	\$1608
	built-up self edge	GRT12WABU	48 x 144 x 29	70	342	21.95	\$1878
14 foot	self edge	GRT14WA	48 x 168 x 29	70	423	26	\$2476
	bullnose edge	GRT14WABN	48 x 168 x 29	70	423	26	\$2476
	T-mold edge	GRT14WATM	48 x 168 x 29	70	423	26	\$2476
	built-up self edge	GRT14WABU	48 x 168 x 29	70	429	28	\$2759
16 foot	self edge	GRT16WA	48 x 192 x 29	70	474	30	\$2604
	bullnose edge	GRT16WABN	48 x 192 x 29	70	474	29.94	\$2604
	T-mold edge	GRT16WATM	48 x 192 x 29	70	474	29.94	\$2604
	built-up self edge	GRT16WABU	48 x 192 x 29	70	480	31.92	\$2912
18 foot	self edge	GRT18WA	48 x 216 x 29	70	525	31.92	\$3210
	bullnose edge	GRT18WABN	48 x 216 x 29	70	525	31.92	\$3210
	T-mold edge	GRT18WATM	48 x 216 x 29	70	525	31.92	\$3210
	built-up self edge	GRT18WABU	48 x 216 x 29	70	532	33.89	\$3586
20 foot	self edge	GRT20WA	48 x 240 x 29	70	576	33.89	\$3256
	bullnose edge	GRT20WABN	48 x 240 x 29	70	576	33.89	\$3256
	T-mold edge	GRT20WATM	48 x 240 x 29	70	576	33.89	\$3256
	built-up self edge	GRT20WABU	48 x 240 x 29	70	584	35.93	\$3621
22 foot	self edge	GRT22WA	48 x 264 x 29	70	626	36.89	\$3640
	bullnose edge	GRT22WABN	48 x 264 x 29	70	626	36.89	\$3640
	T-mold edge	GRT22WATM	48 x 264 x 29	70	626	36.89	\$3640
	built-up self edge	GRT22WABU	48 x 264 x 29	70	634	37.90	\$4070
24 foot	self edge	GRT24WA	48 x 288 x 29	70	678	39.88	\$3728
	bullnose edge	GRT24WABN	48 x 288 x 29	70	678	39.88	\$3728
	T-mold edge	GRT24WATM	48 x 288 x 29	70	678	39.88	\$3728
	built-up self edge	GRT24WABU	48 x 288 x 29	70	687	41.92	\$4153

- All tops over 144" are standard in two pieces. Woodgrain laminate finishes will NOT align where the two tops join.
- All tops 168", 192", 216" and 240" are SHIPPED WITH 2 ARCH BASES AND 1 SLAB BASE.
- All tops 264" and 288" are SHIPPED WITH 2 ARCH BASES AND 2 SLAB BASES.

Required Specifications

Finish
Base Finish
Edge Color, if applicable

Optional Specifications

Grommet

Accessories

Power Block

RACETRACK TOP - 2 LEG BASE

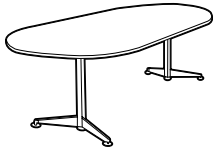

	MODEL#	DIMENSIONS	FREIGHT	CLASS	WT/LBS.	CUBIC FT.	LIST PRICE	HP ADD
	D x W x H							
5 foot	self edge	GRT5	30 x 60 x 29	125	88	13	\$846	
	bullnose edge	GRT5BN	30 x 60 x 29	125	88	13	\$846	
	T-mold edge	GRT5TM	30 x 60 x 29	125	88	13	\$846	
	built-up self edge	GRT5BU	30 x 60 x 29	125	91	14	\$944	
6 foot	self edge	GRT6	36 x 72 x 29	125	111	15	\$942	
	bullnose edge	GRT6BN	36 x 72 x 29	125	119	15	\$942	
	T-mold edge	GRT6TM	36 x 72 x 29	125	119	15	\$942	
	built-up self edge	GRT6BU	36 x 72 x 29	100	136	16	\$1047	
7 foot	self edge	GRT7	44 x 84 x 29	100	155	17	\$1088	
	bullnose edge	GRT7BN	44 x 84 x 29	100	155	17	\$1088	
	T-mold edge	GRT7TM	44 x 84 x 29	100	155	17	\$1088	
	built-up self edge	GRT7BU	44 x 84 x 29	100	158	19	\$1220	
8 foot	self edge	GRT8W	48 x 96 x 29	100	178	19	\$1088	
	bullnose edge	GRT8WBN	48 x 96 x 29	100	180	19	\$1088	
	T-mold edge	GRT8WTM	48 x 96 x 29	100	178	19	\$1088	
	built-up self edge	GRT8WBU	48 x 96 x 29	100	204	21	\$1220	
10 foot	self edge	GRT10W	48 x 120 x 29	300	39	21	\$1513	
	bullnose edge	GRT10WBN	48 x 120 x 29	92.5	231	21	\$1513	
	T-mold edge	GRT10WTM	48 x 120 x 29	92.5	221	21	\$1513	
	built-up self edge	GRT10WBU	48 x 120 x 29	92.5	254	23	\$1693	
12 foot	self edge	GRT12W	48 x 144 x 29	92.5	271	23	\$1701	
	bullnose edge	GRT12WBN	48 x 144 x 29	92.5	268	23	\$1701	
	T-mold edge	GRT12WTM	48 x 144 x 29	92.5	268	23	\$1701	
	built-up self edge	GRT12WBU	48 x 144 x 29	92.5	301	25.90	\$1898	
14 foot	self edge	GRT14W	48 x 168 x 29	100	326	34	\$1953	
	bullnose edge	GRT14WBN	48 x 168 x 29	100	326	34	\$1953	
	T-mold edge	GRT14WTM	48 x 168 x 29	100	326	34	\$1953	
	built-up self edge	GRT14WBU	48 x 168 x 29	100	332	38	\$2159	
16 foot	self edge	GRT16W	48 x 192 x 29	100	367	38	\$2041	
	bullnose edge	GRT16WBN	48 x 192 x 29	100	367	38	\$2041	
	T-mold edge	GRT16WTM	48 x 192 x 29	100	367	38	\$2041	
	built-up self edge	GRT16WBU	48 x 192 x 29	100	368	40	\$2210	
18 foot	self edge	GRT18W	48 x 216 x 29	92.5	408	40	\$2431	
	bullnose edge	GRT18WBN	48 x 216 x 29	92.5	408	40	\$2431	
	T-mold edge	GRT18WTM	48 x 216 x 29	92.5	408	40	\$2431	
	built-up self edge	GRT18WBU	48 x 216 x 29	100	416	42	\$2712	
20 foot	self edge	GRT20W	48 x 240 x 29	92.5	449	42	\$2517	
	bullnose edge	GRT20WBN	48 x 240 x 29	92.5	449	42	\$2517	
	T-mold edge	GRT20WTM	48 x 240 x 29	92.5	449	42	\$2517	
	built-up self edge	GRT20WBU	48 x 240 x 29	92.5	457	44	\$2795	
22 foot	self edge	GRT22W	48 x 264 x 29	92.5	489	44	\$2777	
	bullnose edge	GRT22WBN	48 x 264 x 29	92.5	489	44	\$2777	
	T-mold edge	GRT22WTM	48 x 264 x 29	92.5	489	44	\$2777	
	built-up self edge	GRT22WBU	48 x 264 x 29	92.5	497	46	\$3126	
24 foot	self edge	GRT24W	48 x 288 x 29	92.5	531	46	\$2862	
	bullnose edge	GRT24WBN	48 x 288 x 29	92.5	531	46	\$2862	
	T-mold edge	GRT24WTM	48 x 288 x 29	92.5	531	46	\$2862	
	built-up self edge	GRT24WBU	48 x 288 x 29	92.5	540	48	\$3200	

- All tops over 144" are standard in two pieces. Woodgrain laminate finishes will NOT align where the two tops join.
- All tops 120", 144", and 168" are SHIPPED WITH 3 LEG BASES.
- All tops 192" are SHIPPED WITH 4 LEG BASES.
- All tops 216", 240", 264" and 288" are SHIPPED WITH 6 LEG BASES.

Required Specifications

Finish
Base Finish
Edge Color, if applicable

Optional Specifications

Grommet

Accessories

Power Block

B BOARDROOM TABLES

RACETRACK TOP - TUBULAR BASE

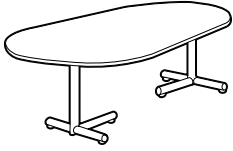

	MODEL#	DIMENSIONS D x W x H	FREIGHT CLASS	WT./LBS.	CUBIC FT.	LIST PRICE	HP ADD
5 foot	self edge	GRT5R	30 x 60 x 29	150	94	21	\$872
	bullnose edge	GRT5RBN	30 x 60 x 29	150	94	21	\$872
	T-mold edge	GRT5RTM	30 x 60 x 29	150	94	21	\$872
	built-up self edge	GRT5RBU	30 x 60 x 29	150	97	23	\$974
6 foot	self edge	GRT6R	36 x 72 x 29	150	107	23	\$968
	bullnose edge	GRT6RBN	36 x 72 x 29	150	107	23	\$968
	T-mold edge	GRT6RTM	36 x 72 x 29	150	107	23	\$968
	built-up self edge	GRT6RBU	36 x 72 x 29	150	117	25	\$1078
7 foot	self edge	GRT7R	44 x 84 x 29	125	161	25	\$1116
	bullnose edge	GRT7RBN	44 x 84 x 29	125	161	25	\$1116
	T-mold edge	GRT7RTM	44 x 84 x 29	125	161	25	\$1116
	built-up self edge	GRT7RBU	44 x 84 x 29	125	164	27	\$1249
8 foot	self edge	GRT8WR	48 x 96 x 29	125	175	27	\$1116
	bullnose edge	GRT8WRBN	48 x 96 x 29	125	177	27	\$1116
	T-mold edge	GRT8WRTM	48 x 96 x 29	125	175	27	\$1116
	built-up self edge	GRT8WRBU	48 x 96 x 29	125	176	29	\$1249
10 foot	self edge	GRT10WR	48 x 120 x 29	125	221	29	\$1529
	bullnose edge	GRT10WRBN	48 x 120 x 29	125	221	29	\$1529
	T-mold edge	GRT10WRTM	48 x 120 x 29	125	221	29	\$1529
	built-up self edge	GRT10WRBU	48 x 120 x 29	125	239	32	\$1715
12 foot	self edge	GRT12WR	48 x 144 x 29	100	270	31	\$1722
	bullnose edge	GRT12WRBN	48 x 144 x 29	100	270	31	\$1722
	T-mold edge	GRT12WRTM	48 x 144 x 29	100	270	30.90	\$1722
	built-up self edge	GRT12WRBU	48 x 144 x 29	100	301	34	\$1922
14 foot	self edge	GRT14WR	48 x 168 x 29	125	330	50	\$1980
	bullnose edge	GRT14WRBN	48 x 168 x 29	125	330	50	\$1980
	T-mold edge	GRT14WRTM	48 x 168 x 29	125	330	50	\$1980
	built-up self edge	GRT14WRBU	48 x 168 x 29	125	326	54	\$2185
16 foot	self edge	GRT16WR	48 x 192 x 29	125	371	54	\$2066
	bullnose edge	GRT16WRBN	48 x 192 x 29	125	371	54	\$2066
	T-mold edge	GRT16WRTM	48 x 192 x 29	125	371	54	\$2066
	built-up self edge	GRT16WRBU	48 x 192 x 29	125	377	58	\$2268
18 foot	self edge	GRT18WR	48 x 216 x 29	125	412	56	\$2448
	bullnose edge	GRT18WRBN	48 x 216 x 29	125	412	56	\$2448
	T-mold edge	GRT18WRTM	48 x 216 x 29	125	412	56	\$2448
	built-up self edge	GRT18WRBU	48 x 216 x 29	125	419	60	\$2734
20 foot	self edge	GRT20WR	48 x 240 x 29	125	453	58	\$2534
	bullnose edge	GRT20WRBN	48 x 240 x 29	125	453	58	\$2534
	T-mold edge	GRT20WRTM	48 x 240 x 29	125	453	58	\$2534
	built-up self edge	GRT20WRBU	48 x 240 x 29	125	461	62	\$2826
22 foot	self edge	GRT22WR	48 x 264 x 29	100	493	60	\$2820
	bullnose edge	GRT22WRBN	48 x 264 x 29	100	493	60	\$2820
	T-mold edge	GRT22WRTM	48 x 264 x 29	100	493	60	\$2820
	built-up self edge	GRT22WRBU	48 x 264 x 29	125	501	64	\$3150
24 foot	self edge	GRT24WR	48 x 288 x 29	100	535	62	\$2909
	bullnose edge	GRT24WRBN	48 x 288 x 29	100	535	62	\$2909
	T-mold edge	GRT24WRTM	48 x 288 x 29	100	535	62	\$2909
	built-up self edge	GRT24WRBU	48 x 288 x 29	100	544	66	\$3233

- All tops over 144" are standard in two pieces. Woodgrain laminate finishes will NOT align where the two tops join.
- All tops 120", 144", and 168" are SHIPPED WITH 3 TUBULAR BASES.
- All tops 192" are SHIPPED WITH 4 TUBULAR BASES.
- All tops 216", 240", 264" and 288" are SHIPPED WITH 6 TUBULAR BASES.

Required Specifications

Finish
Base Finish
Edge Color, if applicable

Optional Specifications

Grommet

Accessories

Power Block

BUNGEE™ TABLES



Features and Benefits

- Bungee tables are complete with Top, Legs and Bungee cords
- Bungee cords provide a fast and easy method of reconfiguring tables without requiring a tool
- Tops are 1" thick and are offered in a variety of shapes and sizes
- Legs are offered in Tapered or Spider design in a Silver or Black finish. Levelers are standard
- Laminate modesty panels and filler modesty inserts help conceal wires and enhance visual appeal
- Wire management tracks neatly contain wires, using two separate channels for data and voice wires
- Optional grommets or power blocks offer technological flexibility
- Models with handles feature a bow handle in Silver or Black Nickel finish
- Metal feet are height adjustable and offered in Silver or Black Nickel finish
- Boardrooms were never easier to specify - table "sets" and accessories such as AV Cabinets and Credenza Buffets are specified with one model number

Bungee is a series of freestanding tables and accessories designed for classrooms, training rooms, boardrooms and any other multi-functional space that may require frequent configurations. Tables are sold complete with legs and Bungee cords so they may quickly and easily be connected together without searching for tools or worrying about loose parts.

Bungee tables feature rounded corners with a unique "bubble molding" that is engineered to compress under the tension of the Bungee cords. The compressed molding creates a seal that serves to locate and align interconnected tables while also providing a soft and forgiving edge.

Choose from a variety of top shapes and laminate finishes to create your individual style. In addition, most tables offer a choice of tapered legs or spider legs in a Silver or Black finish with adjustable levlers or optional casters. Optional modesty panels, grommets, wire management and power blocks further enhance your workspace.



Flip-Top tables can be nested and easily stored by activating the single hand release mechanism from the left or right side.

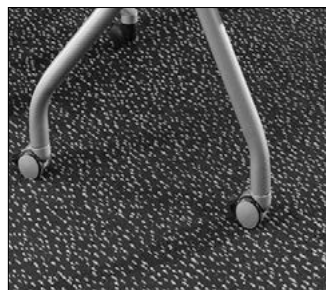

Optional locking casters are available in Silver or Black finish (standard on Flip-Top models).

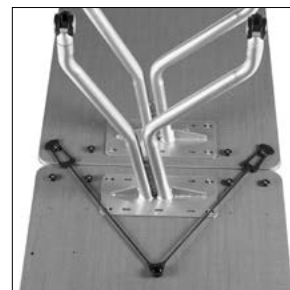

Bungee cords are utilized to quickly and easily reconfigure tables

GENERAL INFORMATION

- Bungee is a series of freestanding tables and accessories designed for classrooms, training rooms, boardrooms and any other multifunctional space that requires frequent reconfigurations.
- Bungee tables come complete with a work top, a set of legs and built-in bungee cord connectors.
- Bungee cords allow the movement and reconfiguration of tables without a risk of damage or losing loose parts.
- High Pressure Tops are available in all Bungee laminate finishes at an extended lead time - please see model # for pricing.
- Unique “bubble molding” edging is specially engineered to create a secure seal to align interconnected tables.
- Bungee products have been tested and comply with all mechanical tests.
- Global laminate and seating products are in compliance with stringent emission guidelines set out by the Greenguard Environmental Institute under the standards for low emitting products and materials. www.greenguard.org
- **Level 3 Certified**

CONSTRUCTION

- Tops are 1” thick. Modesty panels are 1/4” thick.
- All components are made of 45 lb. commercial density particle board, covered on both sides with high performance, thermally fused laminate.
- Tops 54” and over feature a built-in support bar.

BUNGEE CORDS

- Bungee cords are patented elastic devices designed to provide a rapid, no-tool method of attaching tables of the same depth.
- The elastic nature of cords allows two connected tables to be moved around without risk of damage to the table top or connecting hardware.
- Bungee cords are included with all freestanding tables and carry a lifetime warranty.

EDGE DETAIL

- Unique “Bubble molding” is engineered to compress under the tension of the Bungee cords, creating a seal that serves to locate and align interconnected tables.
- Bubble molding finish matches surface laminate with Silver (**SI**) or Black (**BK**) accent trim.
- Cabinetry and accessories feature Global’s preferred edging in matching color.

LEGS

- Tables feature two styles of legs - Tapered Leg and Spider Leg. Available in Silver Finish (**SI**) or Black Finish (**BK**).
- Levelers are standard. Optional locking casters are available at no upcharge, specify as Silver (**CS**) or Black (**CK**). (Casters must match base finish.) Adjust 3mm - 10mm in height.

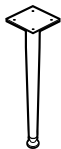

Tapered Leg



Spider Leg

HANDLES

- Metal handles are standard on all drawers and doors. Handles are offered in two finishes, Silver or Black.
- Handle finish will match leg finish.



Bow Handle, Silver (**HS**)



Bow Handle, Black Nickel (**HT**)

FEET

- Metal feet are standard on all cabinets. Feet adjust 3/4” in height.
- Feet are available in Silver Finish (**SI**) or Black Finish (**BK**).



SI - Silver Finish



BK - Black Nickel Finish

MODESTY PANELS

- Panels are 9.5” high, recessed 3/4” from the back and inset 7” from the sides.
- Available in all Bungee laminate finishes.
- Edge available in Silver finish (**SI**) or Black finish (**BK**). Please specify.

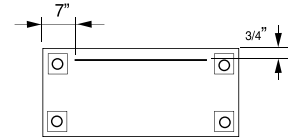
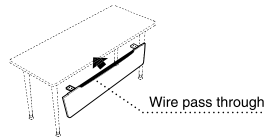

FILLER MODESTY PANELS

- Used to fill the space between two modesty panels when two tables are linked together. Helps conceal wires and enhance visual appeal.
- Available in Silver Finish (**SI**) or Black Finish (**BK**). Please specify.

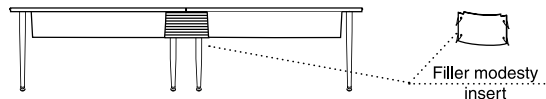

WIRE MANAGEMENT

- Wire management tracks are mounted to the underside of the worksurface. Available in 5” and 22” track lengths.
- 5” track includes one wire clamp; 22” track includes two wire clamps.
- Data and voice wires can be routed separately using two separate channels on each clamp.
- Available in Black only.

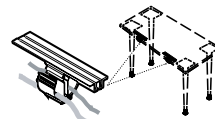

5” Wire Management Track

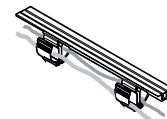

22” Wire Management Track

1. SPECIFY MODEL NUMBER

2. SPECIFY FINISH

Laminate Finishes:

ACJ Absolute Acajou	ASN Asian Night
AWC Avant Cherry	AWH Avant Honey
BLK Black	BRC Brushed Cobalt
CSJ Constellation Java	DES Dark Espresso
HGT Hayden Grey	QTM Quartered Mahogany
SKC Shaker Cherry	SOG Storm Grey
TFW Tiger Fruitwood	TMA Tiger Mahogany
TMP Tiger Maple	TWL Tiger Walnut
WHT White	WHC White Chocolate*
WGY Willow Grey	WCR Winter Cherry

*textured

Legs:

SI Silver
BK Black Nickel

Handles:

Silver
Black Nickel

Feet:

SI Silver
BK Black Nickel

Casters:

CS Silver
CK Black Nickel

3. SPECIFY OPTIONS

GROMMETS

- Optional Grommets available in standard worksurface locations (left, center or right) for **Rectangular Tops 48" and up**. Order as: **AG1, AG2 or AG3 - Add \$65**
- Additional grommets are available in **center position only** for **Rectangular Tops (36", 42" and 48") and Trapezoid Tables**. Order as **AG2 - Add \$65**.
- Grommet hole dimensions are 3 1/4" wide x 1 7/8" deep.
- Grommets may be placed at non-standard locations. Order as: **AGS - ADD \$65.00** A drawing must be supplied with vertical and horizontal dimensions to the center of the cut-out (as in drawing above). Please refer to CUSTOM GROMMET LOCATION FORM in the back reference section.

Grommet hole dimensions

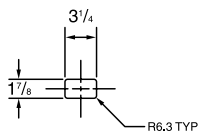

Grommet

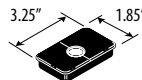

Rectangular Tops

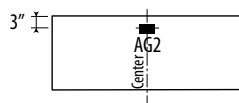

For 36" and 42" wide units

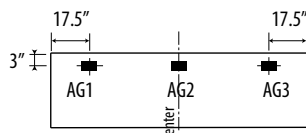

For 48", 60" and 72" wide units



Trapezoid Tables

Grommet Location - **AG2...Add \$65**

POWER BLOCK

- A Power Block is a rectangular worksurface power/data module with one electrical duplex receptacle and two data (RJ45) receptacles. 9' black cord included. Power Block dimensions are 3 1/2" deep x 6 1/2" wide x 2 3/4" high.
- A Power Block (model **PMSPPDM**) may be ordered for **Rectangular Tables 60" and up** in place of standard grommets. Order as **E1, E2 or E3 - Add \$65.00**.
- Additional Power Blocks are available in **center position only** for **Rectangular Tops (36", 42" and 48") and Trapezoid Tables**. Order as **E2 - Add \$65**.
- To purchase a Power Block, you must specify both the Power Block cut-out location and the Power Block model #. Order Power Block as **PMSPPDM, ADD \$238**.
- Power Blocks are available in standard worksurface locations (left, center or right). Order as **E1, E2 or E3. ADD \$65.00**.

- See above for examples of placement.



Power Block **PMSPPDM Add \$238**

VILLA CUTOUTS

- Optional Villa cutout available in standard worksurface locations (left, center or right) for **Rectangular Tables 60" and up**. Order as: **V1, V2 or V3.....Add \$65 for each cutout**.
- Additional power block cutouts are available in **center position only** for **Rectangular Tops (36", 42" and 48") and Trapezoid Tables**. Order as **V2 - Add \$65**.
- Villa cutouts may be placed at non-standard locations. Please contact customer care.
- **Villa is only available on Bungee, Junction and Connectables series**
- To purchase a Villa Power Block, you must specify both the Villa Power Block cutout location and the Power Block model #. Please see page 645 for Villa models.

Rectangular Tops

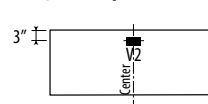

For 36", 42" and 48" wide units

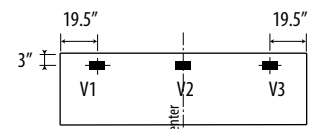

For 60" and 72" wide units

B BUNGEE™ TABLES

CONNECTING CONDITIONS

- Bungee cords allow for fast and easy reconfiguring of tables whenever needed. Due to the elastic nature of the bungee cord, two tables connected with bungee cords can be moved around without risk of damage to the table top or the connecting hardware.
- Connecting tables is simple and intuitive. Tools are not required and there are no loose parts that may be misplaced.
- Bungee cords connect tables of the same depth in all directions.
- Rectangular Tables 48" and longer connect in both Straight and "L" configurations. Rectangular Tables 36" and 42" connect in Straight configurations only.

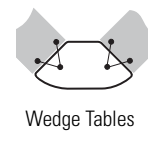
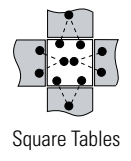
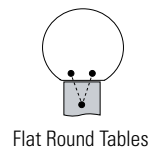
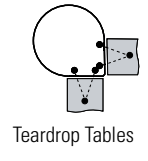
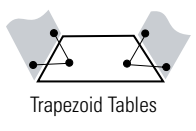
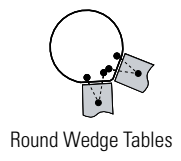
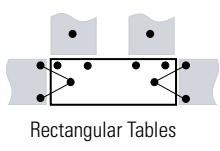
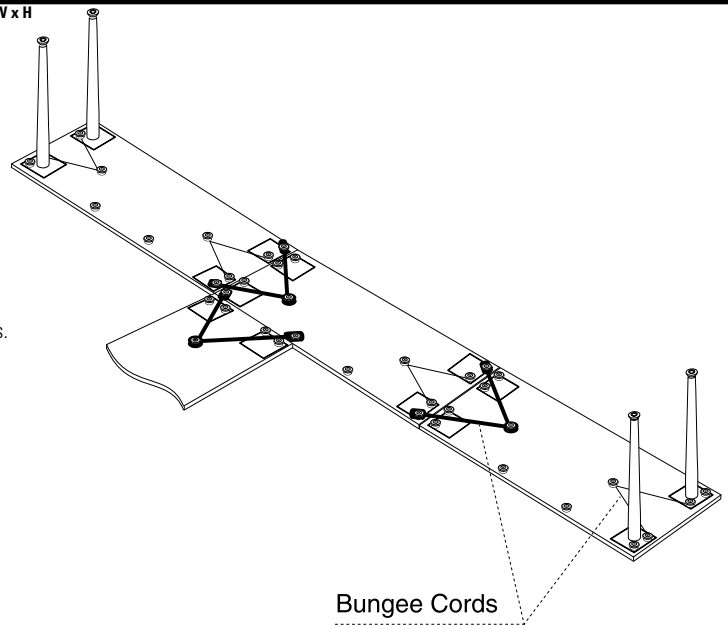

SAMPLE TABLE CONFIGURATIONS

• The following table configurations can be created using Bungee Boardroom Table Sets only. See pages 436 and 439 for specific models / configurations.

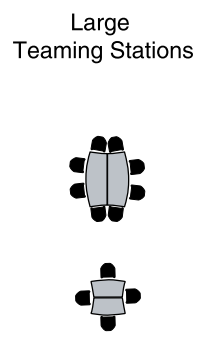
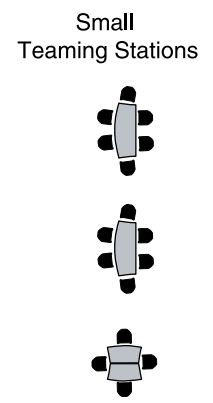
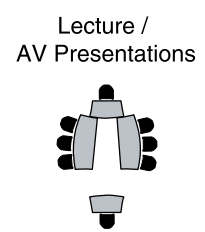
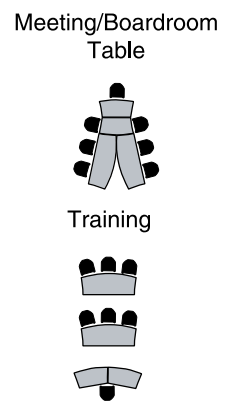
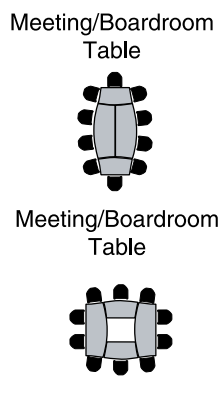

FLIP TOP TABLE NESTING DIAGRAM

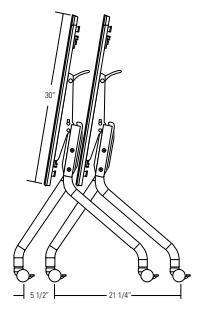
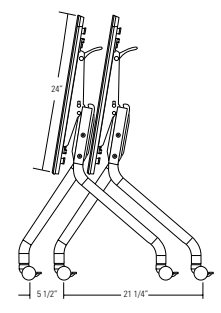
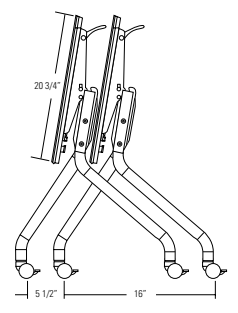

RECTANGULAR TABLES

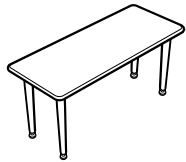
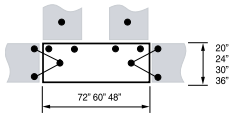
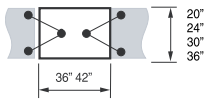

Rectangular Table - Tapered Legs

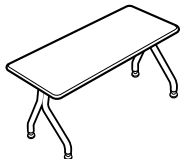
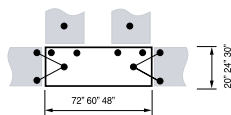
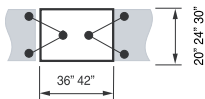

Rectangular Table - Spider Legs

MODEL#	DIMENSIONS	FREIGHT CLASS	WT/LBS.	CUBIC FT.	LIST PRICE	HP ADD
D x W x H						
B2036REF	20 x 36 x 29	92.5	59	5.26	\$617	\$124
B2042REF	20 x 42 x 29	92.5	62	5.76	\$640	\$165
B2048REF	20 x 48 x 29	92.5	67	6	\$665	\$165
B2060REF	20 x 60 x 29	92.5	74	7	\$753	\$228
B2072REF	20 x 72 x 29	92.5	81	7.26	\$825	\$258
B2436REF	24 x 36 x 29	92.5	65	5.76	\$653	\$124
B2442REF	24 x 42 x 29	92.5	69	6	\$676	\$165
B2448REF	24 x 48 x 29	92.5	72	6.50	\$699	\$165
B2460REF	24 x 60 x 29	92.5	82	7.26	\$807	\$248
B2472REF	24 x 72 x 29	92.5	91	8	\$872	\$387
B3036REF	30 x 36 x 29	100	70	7.26	\$646	\$233
B3042REF	30 x 42 x 29	92.5	78	7.50	\$676	\$258
B3048REF	30 x 48 x 29	92.5	81	7.50	\$695	\$248
B3060REF	30 x 60 x 29	92.5	92	8.26	\$807	\$310
B3072REF	30 x 72 x 29	92.5	102	9	\$884	\$387
B3642REF	36 x 42 x 29	150	83	15	\$741	\$248
B3648REF	36 x 48 x 29	92.5	91	8	\$812	\$234
B3660REF	36 x 60 x 29	92.5	103	9	\$884	\$292
B3672REF	36 x 72 x 29	92.5	116	10	\$989	\$371

Freestanding table includes four tapered legs with levellers and Bungee cords. Each table can be "Bungee-tied" to other tables of the same depth. Shipped RTA (ready to assemble). Modesty panels available, see pg 583.

- **Tables 48" and longer connect in both Straight and "L" configurations**
- **Tables 36" and 42" connect in Straight configurations only.**
- Available with optional locking casters, specify option "CS" or "CK".

B2036RES	20 x 36 x 29	100	57	6.76	\$695	\$124
B2042RES	20 x 42 x 29	100	60	7.26	\$717	\$165
B2048RES	20 x 48 x 29	100	65	7.50	\$741	\$165
B2060RES	20 x 60 x 29	100	72	8.50	\$836	\$228
B2072RES	20 x 72 x 29	100	79	8.76	\$912	\$258
B2436RES	24 x 36 x 29	100	62	7.26	\$735	\$124
B2442RES	24 x 42 x 29	150	64	15	\$753	\$165
B2448RES	24 x 48 x 29	125	71	10	\$782	\$165
B2460RES	24 x 60 x 29	125	80	10.76	\$884	\$248
B2472RES	24 x 72 x 29	125	89	11.26	\$959	\$387
B3036RES	30 x 36 x 29	125	72	10.26	\$753	\$233
B3042RES	30 x 42 x 29	125	80	10.50	\$776	\$258
B3048RES	30 x 48 x 29	125	83	10.50	\$801	\$285
B3060RES	30 x 60 x 29	100	94	11.26	\$912	\$285
B3072RES	30 x 72 x 29	100	104	12	\$978	\$388

Freestanding table includes two spider legs with levellers and Bungee cords. Each table can be "Bungee-tied" to other tables of the same depth. Shipped RTA (ready to assemble). Modesty panels available, see pg 583.

- **Tables 48" and longer connect in both Straight and "L" configurations**
- **Tables 36" and 42" connect in Straight configurations only.**
- Available with optional locking casters, specify option "CS" or "CK".

Required Specifications

Top Finish
Leg Finish

Optional Specifications

Casters
Grommet
Modesty Panel
High Pressure Laminate

Accessories

Power Block

B BUNGEE™ TABLES

TRAPEZOID TABLES

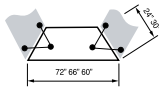

Trapezoid Table - Tapered Legs

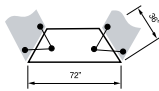
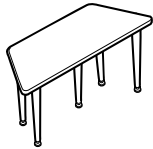

Trapezoid Table - Tapered Legs

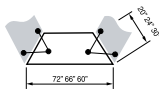
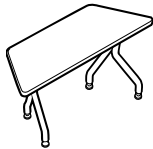

Trapezoid Table - Spider Legs

MODEL#	DIMENSIONS D x W x H	FREIGHT CLASS	WT/LBS.	CUBIC FT.	LIST PRICE	HP ADD
B2460TRF	24 x 60 x 29	100	71	7.50	\$741	\$248
B2466TRF	24 x 66 x 29	100	74	8	\$760	\$387
B2472TRF	24 x 72 x 29	100	78	8.26	\$817	\$387
B3060TRF	30 x 60 x 29	100	78	8.50	\$793	\$285
B3066TRF	30 x 66 x 29	100	81	9.50	\$825	\$387
B3072TRF	30 x 72 x 29	100	85	9.50	\$877	\$387

Freestanding table includes four tapered legs with levellers and Bungee cords. Each table can be "Bungee-tied" to other tables of the same depth. Shipped RTA (ready to assemble). Modesty panels available, see pg 583.

B3672TRF	36 x 72 x 29	100	91	10.50	\$1013	\$371
----------	--------------	-----	----	-------	---------------	--------------

Freestanding table includes five tapered legs with levellers and Bungee cords. Each table can be "Bungee-tied" to other tables of the same depth. Shipped RTA (ready to assemble). Modesty panels available, see pg 583.

- Available with optional locking casters, specify option "**CS**" or "**CK**".

B2060TRS	20 x 60 x 29	125	67	8.76	\$801	\$228
B2066TRS	20 x 66 x 29	125	68	9	\$825	\$258
B2072TRS	20 x 72 x 29	125	74	9.26	\$858	\$258
B2460TRS	24 x 60 x 29	125	69	9.26	\$825	\$248
B2466TRS	24 x 66 x 29	125	72	9.76	\$858	\$387
B2472TRS	24 x 72 x 29	125	76	10	\$894	\$387
B3060TRS	30 x 60 x 29	125	79	11.50	\$888	\$285
B3066TRS	30 x 66 x 29	125	83	12.50	\$920	\$387
B3072TRS	30 x 72 x 29	125	87	12.50	\$971	\$387

Freestanding table includes two spider legs with levellers and Bungee cords. Each table can be "Bungee-tied" to other tables of the same depth. Shipped RTA (ready to assemble). Modesty panels available, see pg 583.

- Available with optional locking casters, specify option "**CS**" or "**CK**".

KEYSTONE TABLES

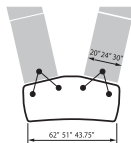
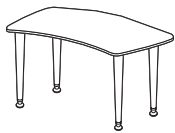

Keystone Table - Tapered Legs

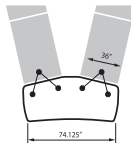
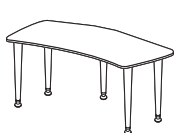

Keystone Table - Tapered Legs

B30KSF	30 x 62 x 29	150	69	15.20	\$786	\$310
B24KSF	24 x 51 x 29	150	60	13	\$728	\$207
B20KSF	20 x 43.75 x 29	150	58	13	\$718	\$165

Freestanding table includes four tapered legs with levellers and Bungee cords. Each table can be "Bungee-tied" to other tables of 24" and 30" depth. Shipped RTA (ready to assemble). Modesty panels or Filler Modestys are NOT available.

B36KSF	36 x 74.13 x 29	150	84	16.80	\$972	\$438
--------	-----------------	-----	----	-------	--------------	--------------

Freestanding table includes five tapered legs with levellers and Bungee cords. Each table can be "Bungee-tied" to other tables of 24" and 30" depth. Shipped RTA (ready to assemble). Modesty panels or Filler Modestys are NOT available.

Required Specifications

Top Finish
Leg Finish

Optional Specifications

Grommet
Casters (Trapezoid Tables only)
Modesty Panel (Trapezoid Tables only)
High Pressure Laminate

Accessories

Power Block

KEYSTONE TABLES

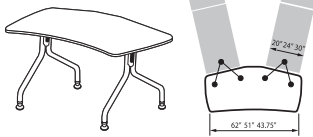

Keystone Table - Spider Legs

MODEL#	DIMENSIONS	FREIGHT CLASS	WT/LBS.	CUBIC FT.	LIST PRICE	HP ADD
	D x W x H					
B30KSS	30 x 62 x 29	150	77	15.20	\$919	\$309
B24KSS	24 x 51 x 29	150	66	13	\$855	\$192
B20KSS	20 x 43.75 x 29	150	64	13	\$839	\$165

Freestanding table includes two spider legs with levelers and Bungee cords. Each table can be "Bungee-tied" to other tables of 24" and 30" depth. Shipped RTA (ready to assemble). Modesty panels or Filler Modestys are NOT available.

WEDGE TABLES

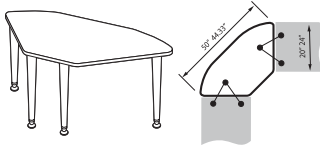

Wedge Table - Tapered Legs

B24WEF	24 x 63 x 29	150	54	13.20	\$761	\$206
B20WEF	20 x 57 x 29	150	46	10.20	\$697	\$165

Freestanding table includes four tapered legs with levelers and Bungee cords. Each table can be "Bungee-tied" to other tables of the same depth. Shipped RTA (ready to assemble). Modesty panels are NOT available.

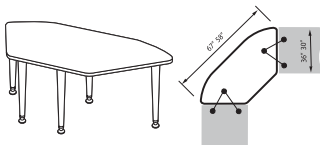

Wedge Table - Tapered Legs

B36WEF	36 x 80 x 29	150	84	18.80	\$1036	\$371
B30WEF	30 x 70 x 29	150	70	14.40	\$919	\$258

Freestanding table includes five tapered legs with levelers and Bungee cords. Each table can be "Bungee-tied" to other tables of the same depth. Shipped RTA (ready to assemble). Modesty panels are NOT available.

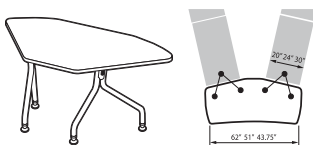

Wedge Table - Spider Legs

B30WES	30 x 70 x 29	150	73	14.40	\$909	\$259
B24WES	24 x 63 x 29	150	62	13.20	\$850	\$206
B20WES	20 x 57 x 29	150	52	10.20	\$786	\$165

Freestanding table includes two spider legs with levelers and Bungee cords. Each table can be "Bungee-tied" to other tables of the same depth. Shipped RTA (ready to assemble). Modesty panels are NOT available.

HALF MOON TABLES

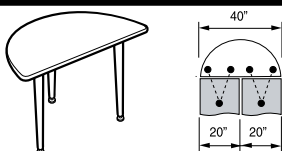

Half Moon Table - Tapered Legs

B2040HMF	20 x 40 x 29	100	49	6	\$488	\$165
----------	--------------	-----	----	---	--------------	--------------

Freestanding table includes three tapered legs with levelers and Bungee cords. Each table can be "Bungee-tied" to other tables of the same depth. Shipped RTA (ready to assemble). Modesty panels or Filler Modestys are NOT available.

- Available with optional locking casters, specify option "CS" or "CK".

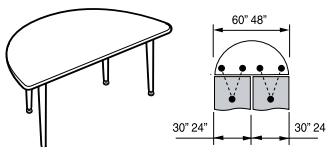

Half Moon Table - Tapered Legs

B2448HMF	24 x 48 x 29	100	69	7.76	\$635	\$165
B3060HMF	30 x 60 x 29	100	81	8.50	\$676	\$285

Freestanding table includes four tapered legs with levelers and Bungee cords. Each table can be "Bungee-tied" to other tables of the same depth. Shipped RTA (ready to assemble). Modesty panels or Filler Modestys are NOT available.

- Available with optional locking casters, specify option "CS" or "CK".

Required Specifications

Top Finish
Leg Finish

Optional Specifications

Casters (Half Moon Tables only)
High Pressure Laminate

Accessories

Power Block (position 2 only)

B BUNGEE™ TABLES

HALF MOON TABLES

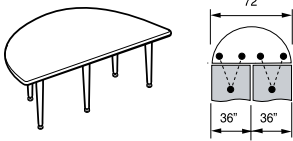

Half Moon Table - Tapered Legs

MODEL#	DIMENSIONS D x W x H	FREIGHT CLASS	WT/LBS.	CUBIC FT.	LIST PRICE	HP ADD
B3672HMF	36 x 72 x 29	100	110	11.50	\$953	\$371

Freestanding table includes five tapered legs with levellers and Bungee cords. Each table can be "Bungee-tied" to other tables of the same depth. Shipped RTA (ready to assemble). Modesty panels or Filler Modestys are NOT available.

- Available with optional locking casters, specify option "**CS**" or "**CK**".

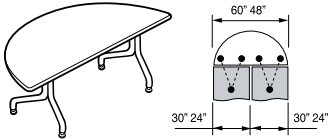

Half Moon Table - Spider Legs

B2448HMS	24 x 48 x 29	125	67	9.26	\$723	\$165
B3060HMS	30 x 60 x 29	125	83	11.50	\$776	\$285

Freestanding table includes two spider legs with levellers and Bungee cords. Each table can be "Bungee-tied" to other tables of the same depth. Shipped RTA (ready to assemble). Modesty panels or Filler Modestys are NOT available.

- Available with optional locking casters, specify option "**CS**" or "**CK**".

SQUARE TABLES

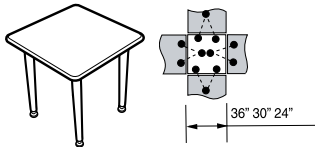

Square Table - Tapered Legs

B2424SQF	24 x 24 x 29	92.5	55	4.60	\$605	\$104
B3030SQF	30 x 30 x 29	100	65	7.50	\$617	\$156
B3636SQF	36 x 36 x 29	100	78	8	\$706	\$187

Freestanding table includes four tapered legs with levellers and Bungee cords. Each table can be "Bungee-tied" to other tables of the same depth. Shipped RTA (ready to assemble). Modesty panels available, see pg 435.

- Available with optional locking casters, specify option "**CS**" or "**CK**".

ROUND WEDGE TABLES

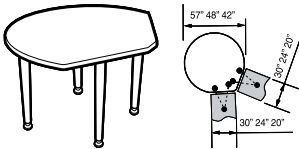

Round Wedge 120° Table

B2042RWF	20 x 42 x 29	100	76	8.26	\$676	\$362
B2448RWF	24 x 48 x 29	125	85	10.76	\$695	\$362
B3057RWF	30 x 57 x 29	100	102	12	\$825	\$516

Freestanding table includes four tapered legs with levellers and Bungee cords. Each table can be "Bungee-tied" to other tables of the same depth. Shipped RTA (ready to assemble). Modesty panels or Filler Modestys are NOT available.

- Available with optional locking casters, specify option "**CS**" or "**CK**".

TEARDROP TABLES

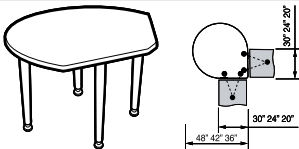

Teardrop 90° Table

B2036TDF	20 x 36 x 29	100	71	8	\$635	\$233
B2442TDF	24 x 42 x 29	100	81	8.50	\$695	\$362
B3048TDF	30 x 48 x 29	100	91	11	\$764	\$336

Freestanding table includes four tapered legs with levellers and Bungee cords. Each table can be "Bungee-tied" to other tables of the same depth. Shipped RTA (ready to assemble). Modesty panels or Filler Modestys are NOT available.

- Available with optional locking casters, specify option "**CS**" or "**CK**".

Required Specifications

Top Finish
Leg Finish

Optional Specifications

Casters
High Pressure Laminate

FLAT ROUND TABLES

MODEL# DIMENSIONS FREIGHT CLASS WT/LBS. CUBIC FT. LIST PRICE HP ADD

D x W x H

B2030FRF	20 x 30 x 29	100	56	6	\$617	\$207
B2036FRF	20 x 36 x 29	100	66	7.26	\$617	\$233
B2436FRF	24 x 36 x 29	100	64	7.26	\$617	\$233
B2442FRF	24 x 42 x 29	100	76	8.26	\$735	\$362
B3042FRF	30 x 42 x 29	100	74	8	\$735	\$362
B3048FRF	30 x 48 x 29	100	88	11	\$735	\$330
B3648FRF	36 x 48 x 29	125	85	11	\$812	\$516
B3652FRF	36 x 52 x 29	100	93	11	\$812	\$516

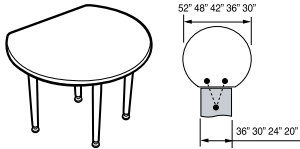

Flat Round Table

Freestanding table includes four tapered legs with levellers and Bungee cords. Each table can be "Bungee-tied" to other tables of the same depth. Shipped RTA (ready to assemble). Modesty panels or Filler Modestys are NOT available.

- Available with optional locking casters, specify option "CS" or "CK".

MODESTY PANELS

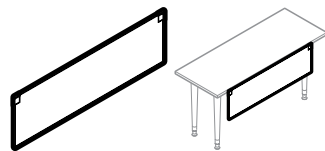

Modesty Panel

BX36QMP	9.5 x 21 x .69	60	3	1.20	\$79	N/A
BX42QMP	9.5 x 27 x .69	60	4	1.35	\$83	N/A
BX48QMP	9.5 x 33 x .69	60	4	1.60	\$88	N/A
BX60QMP	9.5 x 45 x .69	60	5	2.10	\$96	N/A
BX66QMP	9.5 x 51 x .69	60	6	2.60	\$100	N/A
BX72QMP	9.5 x 57 x .69	60	7	2.60	\$104	N/A

For use on **Rectangular** and **Square** Tables. Includes hinged mounting bracket. Available in all Bungee laminate finishes. Edge available in Silver finish (SI) or Black finish (BK).

- Modesty panel model number indicates the width of table to be used on.

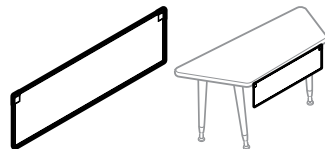

Modesty Panel

BXM60QMP	9.5 x 21 x .69	60	4	1.20	\$83	N/A
BXM66QMP	9.5 x 27 x .69	60	4	1.35	\$88	N/A
BXM72QMP	9.5 x 33 x .69	60	5	1.60	\$92	N/A
BXL60QMP	9.5 x 21 x .69	60	3	1.20	\$81	N/A
BXL66QMP	9.5 x 27 x .69	60	4	1.35	\$83	N/A
BXL72QMP	9.5 x 33 x .69	60	4	1.60	\$88	N/A

For use on **Trapezoid** Tables. Includes hinged mounting bracket. Intended for use on the short side of the table; may be used on long side but leaves a larger gap. Available in all Bungee laminate finishes.

- Modesty panel model number indicates the width of table to be used on.
- Specify **BXM** models for 24" D tables and **BXL** models for 30" D tables.

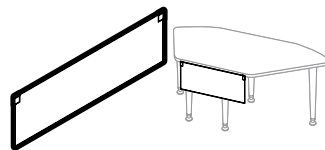

Modesty Panel

BXWQMP	9.5 x 27 x .69	60	4	.40	\$83	N/A
--------	----------------	----	---	-----	-------------	-----

For use on **Wedge** Tables. Includes hinged mounting bracket. Intended for use on the short side of the table. Available in all Bungee laminate finishes.

Edge available in Silver finish (SI) or Black finish (BK).

Required Specifications

Top Finish
Leg Finish

Optional Specifications

Casters
High Pressure Laminate (Flat Round Table only)

B BUNGEE™ TABLES

FILLER MODESTY PANELS



Filler Modesty Panel - Straight

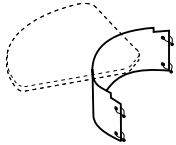

Filler Modesty Panel - Inside Curve

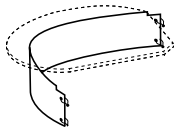

Filler Modesty Panel - Outside Curve

MODEL#	DIMENSIONS D x W x H	FREIGHT CLASS	WT/LBS.	CUBIC FT.	LIST PRICE	HP ADD
BSFMS	.06 x 21 x 9	70	1	.30	\$86	N/A

Used to fill the space between two modesty panels where tables are linked in a straight configuration.

- Filler modesty panels are reversible with Black (BK) finish on one side and Silver (SI) finish on the opposite side.

B23IFMS	.06 x 23 x 9	250	3	1.50	\$103	N/A
B29IFMS	.06 x 29 x 9	250	3	1.50	\$103	N/A
B30IFMS	.06 x 30 x 9	250	3	1.50	\$103	N/A

Used to fill the space (inside curve) between two modesty panels where tables are linked at an angle or curve. Use for the inside curve of Round Wedge Tables, Teardrop Tables, or Trapezoid Tables.

- Use model **B23IFMS** for Trapezoid Tables inside curve only.
- Use model **B29IFMS** for Teardrop Tables inside curve only.
- Use model **B30IFMS** for Round Wedge Tables inside curve only.
- Filler modesty panels are reversible with Black (BK) finish on one side and Silver (SI) finish on the opposite side.

B56S	.06 x 56 x 9	250	4	1.50	\$151	N/A
B62S	.06 x 62 x 9	250	4	1.50	\$162	N/A
B71S	.06 x 71 x 9	250	4	1.50	\$175	N/A

Used to fill the space (outside curve) between two modesty panels where tables are linked at an angle or curve. Use for Teardrop Tables only (**B2036TDF, B2442TDF and B3048TDF**).

- Use model **B56S** for **B2036TDF** Teardrop Tables outside curve only.
- Use model **B62S** for **B2442TDF** Teardrop Tables outside curve only.
- Use model **B71S** for **B3048TDF** Teardrop Tables outside curve only.
- Filler modesty panels are reversible with Black (BK) finish on one side and Silver (SI) finish on the opposite side.

Required Specifications

Top Finish
Leg Finish

Optional Specifications

Casters
Grommet
Modesty Panel

WIRE MANAGEMENT

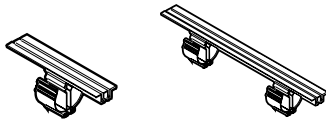

Wire Management - 5" /22" Track

MODEL#	DIMENSIONS D x W x H	FREIGHT CLASS	WT/LBS.	CUBIC FT.	LIST PRICE	HP ADD
BWMS5	2 x 5 x 3.5	70	1	.10	\$9	N/A
BWMD22	2 x 22 x 3.5	70	1	.10	\$15	N/A

Retrofittable track mounts to the underside of worksurface. Includes wire clamp that can route data and voice wires separately. Black only.

- For a 5" track, order model **BWMS5** - includes one wire clamp.
- For a 22" track, order model **BWMD22** - includes two wire clamps.

BOARDROOM TABLE SETS

11 Foot Configurations

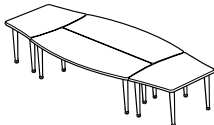

Boardroom Table Set - 11 foot

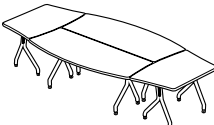

Boardroom Table Set - 11 foot

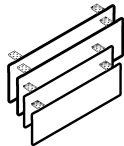

Modesty Panel Set for Boardroom Table

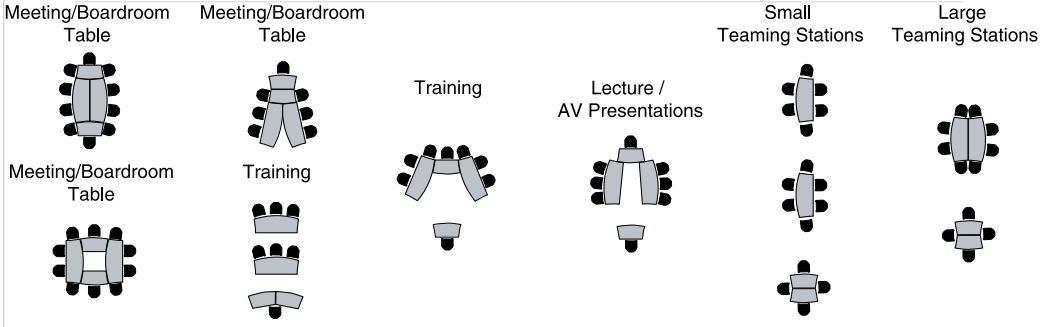

BK132F	60 x 132 x 29	85	290	19.46	\$2992	\$1136
--------	---------------	----	-----	-------	--------	--------

Includes four freestanding tables. Each table includes **four tapered legs** with levellers and Bungee cords to be "Bungee-tied" together. Shipped RTA (ready to assemble). Modesty panel set available, order **BK132MP**.

- Available with optional locking casters, specify option "**CS**" or "**CK**".

BK132S	60 x 132 x 29	85	290	19.46	\$3358	\$1136
--------	---------------	----	-----	-------	--------	--------

Includes four freestanding tables. Each table includes **two spider legs** with levellers and Bungee cords to be "Bungee-tied" together. Shipped RTA (ready to assemble). Modesty panel set available, order **BK132MP**.

- Available with optional locking casters, specify option "**CS**" or "**CK**".

BXK132QMP	.69 x 34 x 9	92.5	13	1.10	\$326	N/A
-----------	--------------	------	----	------	-------	-----

For use on **11 foot Boardroom Table Set**. Includes mounting bracket and wire access sweep. Available in all Bungee laminate finishes.

Required Specifications

- Top Finish
- Leg Finish

Optional Specifications

- Casters
- Grommet
- Modesty Panel
- High Pressure Laminate

B BUNGEE™ TABLES

BOARDROOM TABLE SETS

13/15 Foot Configurations

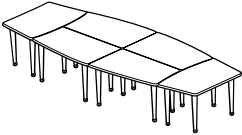

Boardroom Table Set - 13 and 15 foot

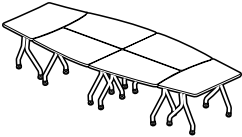

Boardroom Table Set - 13 and 15 foot

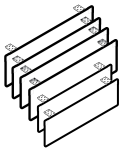

Modesty Panel Set for Boardroom Table

MODEL#	DIMENSIONS D x W x H	FREIGHT CLASS	WT./LBS.	CUBIC FT.	LIST PRICE	HP ADD
	Meeting/Boardroom Table	Lecture / AV Presentations	Training		Small Teaming Stations	Large Teaming Stations
	Meeting/Boardroom Table	Lecture / AV Presentations	Meeting/Boardroom Table	Training	Small Teaming Stations	
BK156F	60 x 156 x 29	85	374	26.31	\$4403	\$1443
BK180F	60 x 180 x 29	100	420	44.05	\$4800	\$1649

Includes six freestanding tables. Each table includes **four tapered legs** with levellers and Bungee cords to be "Bungee-tied" together. Shipped RTA (ready to assemble). Modesty panel set available, order **BK156MP/BK180MP**.

- Available with optional locking casters, specify option "**CS**" or "**CK**".

BK156S	60 x 156 x 29	85	374	26.31	\$4545	\$1443
BK180S	60 x 180 x 29	70	420	26.31	\$4928	\$1649

Includes six freestanding tables. Each table includes **two spider legs** with levellers and Bungee cords to be "Bungee-tied" together. Shipped RTA (ready to assemble). Modesty panel set available, order **BK156MP/BK180MP**.

- Available with optional locking casters, specify option "**CS**" or "**CK**".

BXK156QMP	.69 x 34 x 9	70	20	1	\$553	N/A
BXK180QMP	.69 x 46 x 9	65	25	1.10	\$531	N/A

For use on **13 & 15 foot Boardroom Table Set**. Includes mounting bracket and wire access sweep.

Available in all Bungee laminate finishes. Edge available in Silver finish (**SI**) or Black finish (**BK**).

- Use model **BXK156QMP** for **BK156F/S** Boardroom Table Set.
- Use model **BXK180QMP** for **BK180F/S** Boardroom Table Set.

Required Specifications

Top Finish
Leg Finish
Caster Finish (must match leg finish)

Optional Specifications

Grommet
Modesty Panel
High Pressure Laminate

Accessories

Power Block

RECTANGULAR TABLE - FLIP TOP

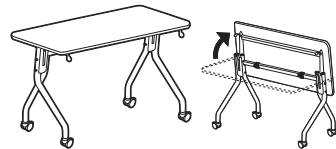
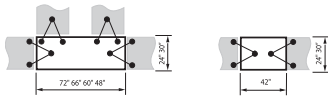

Flip-Top Rectangular Table - Spider Legs

MODEL#	DIMENSIONS	FREIGHT CLASS	WT/LBS.	CUBIC FT.	LIST PRICE	HP ADD
	D x W x H					
BX2442RES	24 x 42 x 29	250	66	20.75	\$1100	\$162
BX2448RES	24 x 48 x 29	250	72	23.50	\$1115	\$162
BX2460RES	24 x 60 x 29	250	84	29	\$1141	\$203
BX2466RES	24 x 66 x 29	250	97	31.75	\$1151	\$243
BX2472RES	24 x 72 x 29	250	102	34.75	\$1172	\$243
BX3042RES	30 x 42 x 29	250	73	25.50	\$1100	\$203
BX3048RES	30 x 48 x 29	250	73	28.75	\$1115	\$203
BX3060RES	30 x 60 x 29	250	94	35.75	\$1146	\$254
BX3066RES	30 x 66 x 29	250	106	39.25	\$1158	\$304
BX3072RES	30 x 72 x 29	250	112	42.50	\$1183	\$304

Table features a flip-top worksurface for ease of storage. Single hand release mechanism can be activated from left or right side of the table. Tables can be nested when folded. Each table can be "Bungee-tied" to other tables of the same depth. Folding modesty panels available, see next page.

- **Tables 48" and longer connect in both Straight and "L" configurations**
- Standard with locking casters
- **Due to leg design, tables placed in back-to-back configurations will not sit flush with one another**

TRAPEZOID TABLES - FLIP TOP

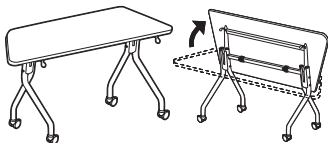
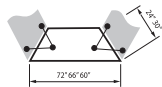

Flip-Top Trapezoid Table - Spider Legs

BX2460TRS	24 x 60 x 29	150	112	28	\$1032	\$203
BX2466TRS	24 x 66 x 29	250	112	31	\$1048	\$243
BX2472TRS	24 x 72 x 29	250	112	33	\$1063	\$243
BX3060TRS	30 x 60 x 29	250	112	35.50	\$1054	\$254
BX3066TRS	30 x 66 x 29	250	112	39	\$1068	\$304
BX3072TRS	30 x 72 x 29	250	112	42.50	\$1084	\$304

Table features a flip-top worksurface for ease of storage. Single hand release mechanism can be activated from left or right side of the table. Tables can be nested when folded. Each table can be "Bungee-tied" to other tables of the same depth. Folding modesty panels available, see next page.

- Standard with locking casters

KEYSTONE TABLES - FLIP TOP

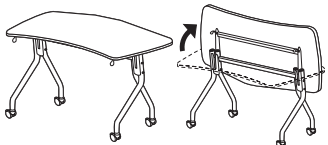

Flip-Top Keystone Table - Spider Legs

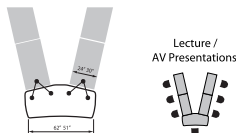

BX24KSS	24 x 51 x 29	125	112	16.50	\$1027	\$203
BX30KSS	30 x 62 x 29	125	112	16.50	\$1068	\$304

Table features a flip-top worksurface for ease of storage. Single hand release mechanism can be activated from left or right side of the table. Tables can be nested when folded. Each table can be "Bungee-tied" to other tables of the same depth.

- Modesty panels or Filler Modestys are NOT available.
- Standard with locking casters

Required Specifications

Top Finish
Leg Finish
Caster Finish (must match leg finish)

Optional Specifications

Grommet
Modesty Panel
High Pressure Laminate

Accessories

Power Block

B BUNGEE™ TABLES

WEDGE TABLES - FLIP TOP

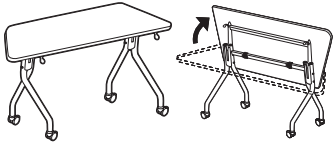

Flip-Top Wedge Table - Spider Legs

MODEL#	DIMENSIONS D x W x H	FREIGHT CLASS	WT/LBS.	CUBIC FT.	LIST PRICE	HP ADD
BX24WES	24 x 63 x 29	60	76	33	\$1293	\$292
BX30WES	30 x 70 x 29	60	84	33	\$1313	\$292

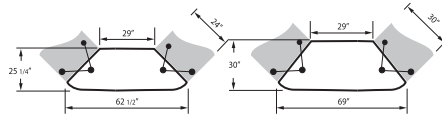
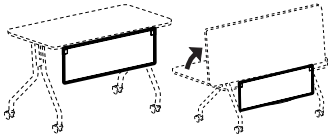

Table features a flip-top worksurface for ease of storage. Single hand release mechanism can be activated from left or right side of the table. Tables can be nested when folded. Each table can be "Bungee-tied" to other tables of the same depth. Folding modesty panels available, see below.

- Standard with locking casters

MODESTY PANELS - FLIP TOP



Modesty Panel

BX36QMP	9.5 x 21 x .69	60	3	1.20	\$79	N/A
BX42QMP	9.5 x 27 x .69	60	4	1.35	\$83	N/A
BX48QMP	9.5 x 33 x .69	60	4	1.60	\$88	N/A
BX60QMP	9.5 x 45 x .69	60	5	2.10	\$96	N/A
BX66QMP	9.5 x 51 x .69	60	6	2.60	\$100	N/A
BX72QMP	9.5 x 57 x .69	60	7	2.60	\$104	N/A

For use on **Flip Top Rectangular Tables**. Includes hinged mounting bracket. Available in all Bungee laminate finishes. Edge available in Silver finish (**SI**) or Black finish (**BK**).

- Modesty panel model number indicates the width of table to be used on.

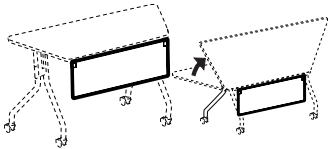

Modesty Panel

BXM60QMP	9.5 x 21 x .69	60	4	1.20	\$83	N/A
BXM66QMP	9.5 x 27 x .69	60	4	1.35	\$88	N/A
BXM72QMP	9.5 x 33 x .69	60	5	1.60	\$92	N/A
BXL60QMP	9.5 x 21 x .69	60	3	1.20	\$81	N/A
BXL66QMP	9.5 x 27 x .69	60	4	1.35	\$83	N/A
BXL72QMP	9.5 x 33 x .69	60	4	1.60	\$88	N/A

For use on **Flip Top Trapezoid Tables**. Includes hinged mounting bracket. Intended for use on the short side of the table; may be used on long side but leaves a larger gap. Available in all Bungee laminate finishes. Edge available in Silver finish (**SI**) or Black finish (**BK**).

- Modesty panel model number indicates the width of table to be used on.

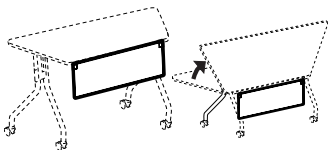

Modesty Panel

BXWQMP	9.5 x 27 x .69	60	4	.40	\$83	N/A
--------	----------------	----	---	-----	-------------	-----

For use on **Flip Top Wedge Tables**. Includes hinged mounting bracket. Intended for use on the short side of the table. Available in all Bungee laminate finishes. Edge available in Silver finish (**SI**) or Black finish (**BK**).

- Modesty panel model number indicates the width of table to be used on.

Required Specifications

Top Finish
Leg Finish
Caster Finish (must match leg finish)

Optional Specifications

Grommet
Modesty Panel
High Pressure Laminate

Accessories

Power Block

BOARDROOM TABLE SET - FLIP TOP

MODEL#

DIMENSIONS

FREIGHT CLASS

WT./LBS.

CUBIC FT.

LIST PRICE

HP ADD

D x W x H

4 pc. Configurations

Meeting/Boardroom Table



Meeting/Boardroom Table



Training



Lecture / AV Presentations



Small Teaming Stations



Large Teaming Stations



Meeting/Boardroom Table



Training



BXK132S

60 x 132 x 29

250

352

148

\$4228

\$1163



Boardroom Table Set - 4pc. Flip Top

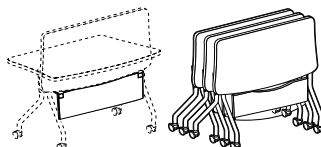

Includes four freestanding tables with spider legs. All tables feature a flip top worksurface for ease of storage. Single hand release mechanism can be activated from left or right side of the table. Tables can be nested when folded. Each table can be "Bungee-tied" to other tables. Folding modesty panel set available, order **BXK132MP**. 4 cartons.

- Standard with locking casters

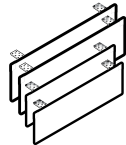

Square Modesty Panel Set for 4pc. Flip Top Table

BXK132QMP

.69 x 34 x 9

92.5

13

1.10

\$326

N/A

For use on **4 pc. flip top table kits**. Modesty panels flip down for storage. Features black wire access sweep. Available in all Bungee laminate finishes. Edge available in Silver finish (**SI**) or Black finish (**BK**).

Required Specifications

- Top Finish
- Leg Finish
- Caster Finish (must match leg finish)

Optional Specifications

- High Pressure Laminate

B BUNGEE™ TABLES

MODESTY PANEL SETS

6 pc. Configurations

MODEL#	DIMENSIONS D x W x H	FREIGHT CLASS	WT/LBS.	CUBIC FT.	LIST PRICE	HP ADD

BXK156S	60 x 156 x 29	250	452	177.1	\$6260	\$1340
BXK180S	60 x 180 x 29	250	507	204.0	\$6411	\$1543



Boardroom Table Set - 6pc. Flip Top

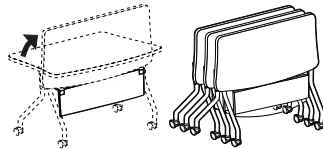

Includes six freestanding tables with spider legs. All tables feature a flip top worksurface for ease of storage. Single hand release mechanism can be activated from left or right side of the table. Tables can be nested when folded. Each table can be "Bungee-tied" to other tables. Folding modesty panel set available, order **BXK156MP/ BXK180MP**. 6 cartons.

- Standard with locking casters

BXK156QMP	.69 x 34 x 13	70	20	1	\$553	N/A
BXK180QMP	.69 x 46 x 13	65	25	1.10	\$531	N/A

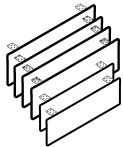

Square Modesty Panel Set for 6 pc. Flip Top Table

For use on **6 pc. flip top table kits**. Modesty panels flip down for storage. Features black wire access sweep. Available in all Bungee laminate finishes. Edge available in Silver finish (**SI**) or Black finish (**BK**).

Required Specifications
Finish

Optional Specifications
Grommet

Accessories
Power Block

ACCESSORIES

MODEL# DIMENSIONS FREIGHT CLASS WT/LBS. CUBIC FT. LIST PRICE HP ADD

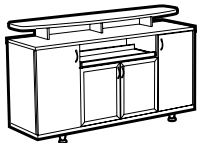

Credenza Buffet

	D x W x H					
B2072BUF	20 x 72 x 42	100	305	37.50	\$2609	\$383

Pull-out shelf. Top transaction shelf is edged with bubble molding. Side storage compartments feature a laminate door and one adjustable shelf each. Center storage features frosted aluminum doors with one adjustable shelf. Leveller feet are standard.

- Some assembly required.

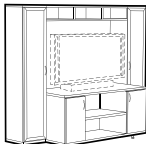

Audio/Visual Cabinet

B249072AV	24 x 90 x 72	92.5	530	52.52	\$4303	\$387
-----------	--------------	------	-----	-------	--------	-------

Top pigeon holes and center adjustable shelf accommodate electronic equipment, CDs and other media. Bottom storage compartments feature laminate doors and one adjustable shelf. Side storage towers feature frosted aluminum doors with three adjustable shelves each. Accommodates TVs up to 58" w x 34" h x 24" d.

- Some assembly required.



Lectern

B44LEC	17 x 22 x 44	250	36	12.50	\$653	\$124
--------	--------------	-----	----	-------	-------	-------

Features angled stand with pencil ledge. Locking casters. **Specify CS or CK.**

Required Specifications

Top Finish
Leg Finish
Feet Finish

Optional Specifications

Grommet

Accessories

Power Block

B BUNGEE SL™ - NOTES



BUNGEE SL - a completely new product line to complement and coordinate with the Bungee Training Tables series. Bungee SL takes the popular aesthetic of the Bungee series and allows tables to be specified in shared leg and permanent applications - great for training, teaming and academic areas. Bungee SL tops and legs are sold separately, increasing the flexibility of the product in the future and allows for space saving in areas where real estate is a premium.

For greater flexibility, specify **Power and Data Management Troughs** for the BUNGEE SL table series. Add Global's proprietary 4-wire power kits and create inexpensive and versatile training, benching, academic and meeting areas. Front panels are available in Laminate or Aluminum. A center spine version allows for inexpensive double-sided applications.



Features and Benefits

- Tops are 1" thick with a choice of four edges: BB/BS - Bungee bubble edge, AB/AS - split color edge, A3 - matching edge and AR - Bicut edge.
- Legs are offered in Tapered or Spider design in a Silver or Black finish. Levelers are standard
- Power and data management troughs are sold separately and are meant to be used on BUNGEE SL only.
- Metal feet are height adjustable and offered in Silver or Black Nickel finish



Tapered leg with levelers, offered in Silver or Black finish.



Optional power and data management troughs for Bungee SL. Center spine shown.



Shared leg, back-to-back tables with center spine trough.

GENERAL INFORMATION

- Introducing **BUNGEE SL** - a completely new product line to complement and coordinate with the top selling Bungee Training Tables series.
- Bungee SL takes the popular aesthetic of the Bungee series and allows tables to be specified in shared leg and permanent applications - great for benching, training, teaming and academic areas.
- Bungee SL tops and legs are sold separately, increasing the flexibility of the product in the future and allows for space saving in areas where real estate is a premium.
- High pressure tops are available in all BUNGEE SL laminates at an extended lead time - please refer to model # for pricing.
- Global laminate and seating products are in compliance with stringent emission guidelines set out by UL/Greenguard Environmental Institute under the standards for low emitting products and materials. www.greenguard.org
- **Level 3 Certified**

CONSTRUCTION

- Tops are 1" thick
- All laminate components are made of 45 lb. density particleboard with high performance thermally fused laminate.
- Tops 60" and over feature a built-in support bar. The support bar is 10" from the approach side, and clearance to the bottom of the support bar is 27" from the floor.
- **BUNGEE CORDS ARE NOT INCLUDED AND ARE NOT COMPATIBLE WITH BUNGEE SL TOPS**

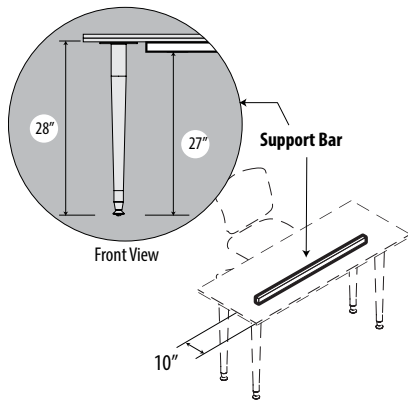

EDGE DETAIL

- Bungee SL comes with a choice of four edge styles:



A3 - square corner, standard edge



AR - square corner, bicut edge



AS - square corner, Silver



AB - square corner, Black



BS - rounded corner, Silver



BB - rounded corner, Black

- **BB/BS** - Bungee Bubble Edge: unique "bubble" molding found on original Bungee
- **AB/AS** - Split color PVC edge: edge matches split color aesthetic of the bubble edge, but allows for 90 degree corners and a cleaner look.
- **A3** - Global's preferred edge. Coordinates well with Adaptabilities and Zira 1" tops.
- **AR** - Bicut edge. Coordinates well with Zira 1" tops.

LEGS

- Two leg styles are available - Tapered and Spider leg. Available in Silver (**SI**) or Black (**BK**) finish. Levelers are standard; casters are not available for Bungee SL legs. Levelers adjust 3mm - 10mm in height.

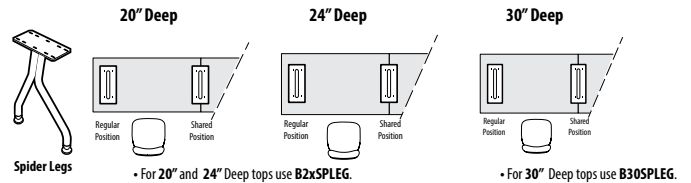

MODESTY PANELS

- See **POWER AND DATA MANAGEMENT TROUGHS** - page 591
- For modesty panels without power and data management, please see **Bungee modesty panels**, found on pages 573

WIRE MANAGEMENT / POWER OPTIONS

- **TO UTILIZE BUNGEE SL TO THE FULLEST EXTENT, SPECIFY POWER AND DATA MANAGEMENT TROUGH (SEE PAGE 591).**
- For basic wire management, see details on page 575.

B BUNGEE SL™ - NOTES

1. SPECIFY MODEL NUMBER

2. SPECIFY FINISH

Laminate Finishes:

ACJ	Absolute Acajou	ASN	Asian Night
AWC	Avant Cherry	AWH	Avant Honey
BLK	Black	BRC	Brushed Cobalt
CSJ	Constellation Java	DES	Dark Espresso
HGT	Hayden Grey	QTM	Quartered Mahogany
SKC	Shaker Cherry	SOG	Storm Grey
TFW	Tiger Fruitwood	TMA	Tiger Mahogany
TMP	Tiger Maple	TWL	Tiger Walnut
WHT	White	WHC	White Chocolate*
WGY	Willow Grey	WCR	Winter Cherry

Edge:

BB	Bungee bubble edge with Black trim
BS	Bungee bubble edge with Silver trim
AB	Split color edge with Black trim
AS	Split color edge with Silver trim
A3	Matching edge
AR	Matching bicut edge

Legs:

SI	Silver
BK	Black

3. SPECIFY OPTIONS

GROMMETS

- Optional Grommets available in standard worksurface locations (left, center or right) **for Rectangular Tops 60" and up**. Order as: **AG1, AG2 or AG3 - Add \$65**
- Optional grommets are available in **center position only** for **Rectangular Tops (36", 42" and 48")**, **Keystone**, **Half-Moon** and **Wedge Tops**. Order as **AG2 - Add \$65**.
- Grommet hole dimensions are 3 1/4" wide x 1 7/8" deep.
- Grommets may be placed at non-standard locations. Order as: **AGS - Add \$65**. A drawing must be supplied with vertical and horizontal dimensions to the center of the cut-out (as in drawing below). Please refer to CUSTOM GROMMET LOCATION FORM in the back reference section.

Grommet hole dimensions

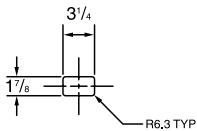

Grommet

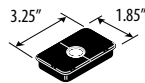

Keystone

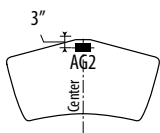

Half Moon

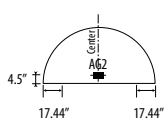

Wedge

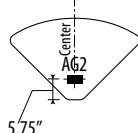

Rectangular Tops

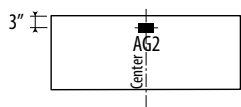

For 36", 42" and 48" wide units

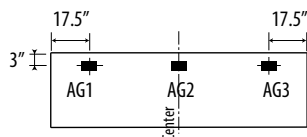

For 60" and 72" wide units

POWER BLOCK

- A Power Block is a rectangular worksurface power/data module with one electrical duplex receptacle and two data (RJ45) receptacles. 9' black cord included. Power Block dimensions are 3 1/2" deep x 6 1/2" wide x 2 3/4" high. Power Block cutout dimensions are 2 3/4" deep x 6" wide.
- A Power Block Cutout (model **PMSPPDM**) may be ordered for **Rectangular Tops (60" and up)** in place of standard grommets. Order as **E1, E2 or E3. Add \$65**.
- A Power Block Cutout (model **PMSPPDM**) may be ordered in the **center position only** for **Rectangular Tops (36", 42" and 48")**, **Keystone** and **Half-Moon Tops**. Order as **E2. Add \$65**.

- To purchase a Power Block, you must specify both the Power Block cut-out location and the Power Block model #. Order Power Block separately as **PMSPPDM, ADD \$238**.

Keystone

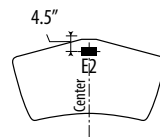

Half Moon

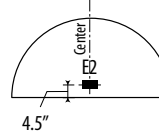

Power Block

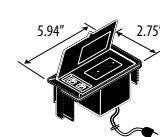

Rectangular Tops

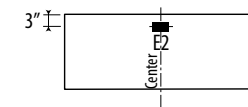

For 36", 42" and 48" wide units

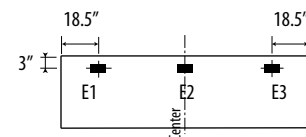

For 60" and 72" wide units

VILLA POWER BLOCK (CORDED VERSION ONLY)

- A Villa Power Block (corded) is available in four options (see page 595 for Villa Corded details). Villa Power Block (corded) dimensions vary by model. Villa cutout dimensions are 3" deep x 5 1/4" wide.
- A Villa cutout may be ordered **for Rectangular Tops 60" and up**. Order as: **V1, V2 or V3 - Add \$65 for each cutout**.
- A Villa cutout may be ordered in the **center position only** for **Rectangular Tops 36", 42" and 48")**, **Keystone** and **Half-Moon Tops**. Order as: **V2 - Add \$65**.
- Order Villa Power Block and Villa Grommet Cover separately, see page 595 for pricing and details.

Keystone

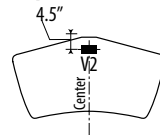

Half Moon

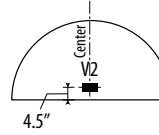

Villa Power Block

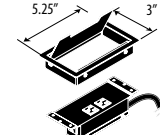

Rectangular Tops

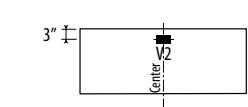

For 36", 42" and 48" wide units

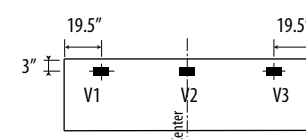

For 60" and 72" wide units

TOPS WITH SQUARE CORNERS (A3, AR OR AB/AS EDGE) MODEL# DIMENSIONS FREIGHT CLASS WT/LBS. CUBIC FT. LIST PRICE HP ADD

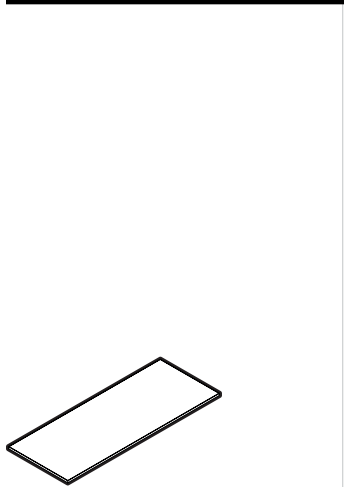

Rectangular Top - Square Corners

	D x W x H					
BS3072REC	30 x 72 x 1	70	60	4	\$405	\$348
BS3060REC	30 x 60 x 1	70	53	3.40	\$338	\$290
BS3048REC	30 x 48 x 1	70	46	2.70	\$206	\$232
BS3042REC	30 x 42 x 1	70	42	2.40	\$201	\$203
BS3036REC	30 x 36 x 1	70	38	2.10	\$161	\$174
BS2472REC	24 x 72 x 1	70	51	3.30	\$355	\$278
BS2460REC	24 x 60 x 1	70	44	2.80	\$309	\$232
BS2448REC	24 x 48 x 1	70	37	2.30	\$175	\$186
BS2442REC	24 x 42 x 1	70	33	2	\$166	\$163
BS2436REC	24 x 36 x 1	70	29	1.80	\$157	\$139
BS2072REC	20 x 72 x 1	85	43	2.90	\$329	\$232
BS2060REC	20 x 60 x 1	70	37	2.40	\$278	\$195
BS2048REC	20 x 48 x 1	70	30	2	\$165	\$163
BS2042REC	20 x 42 x 1	70	27	1.80	\$152	\$139
BS2036REC	20 x 36 x 1	70	24	1.50	\$142	\$139

Rectangular 1" thick worksurface with **Square Corners**. Can accept Tapered (B29TPLEG) or Spider Legs (B2XSPLEG / B30SPLEG) in "end of run" or shared leg positions. Tops 60" and up include a built-in support bar. Shipped RTA (ready to assemble). Compatible with **power and data management troughs** (see page 591) or standard modesty panels (see page 573).

- For worksurfaces to be used as a return, please see Return Tops.
- Legs sold separately.

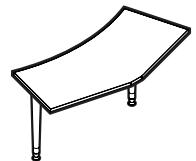

Keystone Top - Square Corners

BS30KSF	30.50 x 62.75 x 1	92.5	37	3.60	\$786	\$348
BS24KSF	28.75 x 52 x 1	92.5	29	2.80	\$728	\$255
BS20KSF	27.75 x 44 x 1	92.5	25	2.40	\$718	\$209

1" thick worksurface with **Square Corners**. Includes (2) Tapered legs. *Not available with Spider Legs*. Connects to other tops of 20", 24" or 30" depths. Shipped RTA (ready to assemble). Modesty panels or filler panels are NOT available.

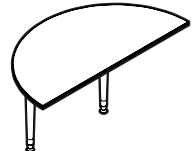

Half Moon Top - Square Corners

BS3060HMF	29.75 x 59.4 x 1	92.5	36	3.30	\$676	\$290
BS2448HMF	24 x 48.2 x 1	92.5	24	2.30	\$635	\$186

1" thick worksurface with **Square Corners**. Includes (2) Tapered legs. *Not available with Spider Legs*. Connects to other tables equaling the same length. Shipped RTA (ready to assemble). Modesty panels or filler panels are NOT available.



90° Wedge Top - Square Corners

BS24WE	26.8 x 26.8 x 1	92.5	15	1.50	\$195	\$163
BS20WE	22.8 x 22.8 x 1	100	10	1.20	\$142	\$139

1" thick worksurface with **Square Corners**. Can accept Tapered (B29TPLEG) or Spider Legs (B2XSPLEG / B30SPLEG) in shared positions only. Shipped RTA (ready to assemble). Accepts filler modesty panels.

- Legs sold separately.

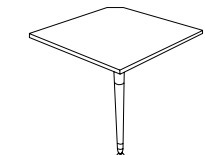

90° Corner - Square Corners

BS30CN	33.17 x 33.17 x 1	125	36	2.50	\$440	\$139
--------	-------------------	-----	----	------	-------	-------

Connects to 30" Deep Rectangular Tables. Includes (1) Tapered leg. *Not available with Spider Legs*.

Required Specifications

Top Finish
Top / Edge Detail

Optional Specifications

Grommet
Power/Data Management Troughs -
(Rectangular tops only)
Modesty Panel (Rectangular tops only)

High Pressure Laminate

Accessories

Power Block
Villa Power Block (Corded)

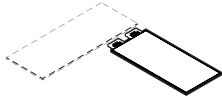

Rectangular Return Tops - Square Corners

MODEL#	DIMENSIONS D x W x H	FREIGHT CLASS	WT./LBS.	CUBIC FT.	LIST PRICE	HP ADD
BS3054RRE	30 x 54 x 1	70	50	3.10	\$221	\$261
BS3048RRE	30 x 48 x 1	70	46	2.70	\$206	\$232
BS3042RRE	30 x 42 x 1	70	42	2.40	\$201	\$203
BS3036RRE	30 x 36 x 1	70	38	2.10	\$161	\$174
BS2454RRE	24 x 54 x 1	70	40	2.50	\$190	\$209
BS2448RRE	24 x 48 x 1	70	37	2.30	\$175	\$186
BS2442RRE	24 x 42 x 1	70	33	2	\$166	\$163
BS2436RRE	24 x 36 x 1	70	29	1.80	\$157	\$139
BS2054RRE	20 x 54 x 1	70	33	2.20	\$180	\$174
BS2048RRE	20 x 48 x 1	70	30	2	\$165	\$156
BS2042RRE	20 x 42 x 1	70	27	1.80	\$152	\$139
BS2036RRE	20 x 36 x 1	70	24	1.50	\$142	\$116

Rectangular 1" thick worksurface with **Square Corners**. Includes two flat brackets to attach to another worksurface on one end. Can accept Tapered (B29TPLEG) or Spider Legs (B2XSPLEG / B30SPLEG) on the other end. 54" tops include a built-in support bar. Shipped RTA (ready to assemble). Compatible with standard modesty panels (see page 573).

- For worksurfaces to be used as a main surface, please see Rectangular Tops.
- Legs sold separately.

TOPS WITH ROUNDED CORNERS (BB/BS EDGES ONLY)



Rectangular Top - Rounded Corners

BB3072REC	30 x 72 x 1	85	59	4	\$520	\$348
BB3060REC	30 x 60 x 1	70	52	3.40	\$434	\$290
BB3048REC	30 x 48 x 1	70	45	2.70	\$264	\$232
BB3042REC	30 x 42 x 1	70	41	2.40	\$258	\$203
BB3036REC	30 x 36 x 1	70	37	2.10	\$207	\$174
BB2472REC	24 x 72 x 1	70	50	3.30	\$456	\$278
BB2460REC	24 x 60 x 1	70	43	2.80	\$396	\$232
BB2448REC	24 x 48 x 1	70	36	2.30	\$224	\$186
BB2442REC	24 x 42 x 1	70	32	2	\$214	\$163
BB2436REC	24 x 36 x 1	70	28	1.80	\$201	\$139
BB2072REC	20 x 72 x 1	85	42	2.90	\$422	\$232
BB2060REC	20 x 60 x 1	70	36	2.40	\$357	\$195
BB2048REC	20 x 48 x 1	85	29	2	\$212	\$163
BB2042REC	20 x 42 x 1	85	26	1.80	\$195	\$139
BB2036REC	20 x 36 x 1	70	23	1.50	\$182	\$139

Rectangular 1" thick worksurface with **Rounded Corners**. Can accept Tapered (B29TPLEG) or Spider Legs (B2XSPLEG / B30SPLEG) in "end of run" or shared leg positions. Tops 60" and up include a built-in support bar. Shipped RTA (ready to assemble). Compatible with **power and data management troughs** (see page 590) or standard modesty panels (see page 573).

- For worksurfaces to be used as a return, please see Return Tops
- Legs sold separately.

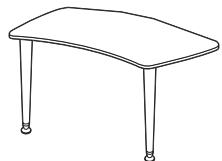

Keystone Top - Rounded Corners

BB30KSF	30.50 x 62.75 x 1	92.5	36	3.60	\$786	\$348
BB24KSF	28.75 x 52 x 1	92.5	28	2.80	\$728	\$255
BB20KSF	27.75 x 44 x 1	92.5	24	2.40	\$718	\$209

1" thick worksurface with **Rounded Corners**. Includes (2) Tapered legs. *Not available with Spider Legs*. Connects to other tops of 20", 24" or 30" depths. Shipped RTA (ready to assemble). Modesty panels or filler panels are NOT available.

Required Specifications

Top Finish
Top / Edge Detail

Optional Specifications

Grommet
Power/Data Management Troughs -
(Rectangular tops only)
Modesty Panel

High Pressure Laminate

Accessories

Power Block
Villa Power Block (Corded)

MODEL# DIMENSIONS FREIGHT CLASS WT/LBS. CUBIC FT. LIST PRICE HP ADD

D x W x H

BB3060HMF	29.75 x 59.4 x 1	92.5	35	3.30	\$676	\$290
BB2448HMF	24 x 48.2 x 1	92.5	23	2.30	\$635	\$186

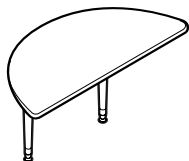

Half Moon Top - Rounded Corners

1" thick worksurface with **Rounded Corners**. Includes (2) Tapered legs. *Not available with Spider Legs*. Connects to other tables equaling the same length. Shipped RTA (ready to assemble). Modesty panels or filler panels are NOT available.



90° Wedge Top - Rounded Corners

BB24WE	26.8 x 26.8 x 1	100	14	1.50	\$250	\$163
BB20WE	22.8 x 22.8 x 1	125	9	1.20	\$182	\$139

1" thick worksurface with **Rounded Corners**. Can accept Tapered (B29TPLEG) or Spider Legs (B2XSPLEG / B30SPLEG) in shared positions only. Shipped RTA (ready to assemble). Accepts filler modesty panels.

- Legs sold separately.

BB3054RRE	30 x 54 x 1	70	50	3.06	\$284	\$261
BB3048RRE	30 x 48 x 1	70	46	2.75	\$264	\$232
BB3042RRE	30 x 42 x 1	70	42	2.44	\$258	\$203
BB3036RRE	30 x 36 x 1	70	38	2.13	\$207	\$174

BB2454RRE	24 x 54 x 1	70	40	2.54	\$243	\$209
BB2448RRE	24 x 48 x 1	70	37	2.28	\$224	\$186
BB2442RRE	24 x 42 x 1	70	33	2.03	\$214	\$163
BB2436RRE	24 x 36 x 1	70	29	1.77	\$201	\$139

BB2054RRE	20 x 54 x 1	70	33	2.20	\$231	\$174
BB2048RRE	20 x 48 x 1	70	30	1.97	\$212	\$156
BB2042RRE	20 x 42 x 1	70	27	1.75	\$195	\$139
BB2036RRE	20 x 36 x 1	70	24	1.53	\$182	\$116

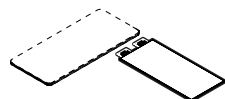

Rectangular Return Tops - Rounded Corners

Rectangular 1" thick worksurface with **Rounded Corners**. Includes two flat brackets to attach to another worksurface on one end. Can accept Tapered (B29TPLEG) or Spider Legs (B2XSPLEG / B30SPLEG) on the other end. 54" tops include a built-in support bar. Shipped RTA (ready to assemble). Compatible with standard modesty panels (see page 573).

- For worksurfaces to be used as a main surface, please see Rectangular Tops
- Legs sold separately.

BB30CN	33.17 x 33.17 x 1	125	36	2.50	\$473	\$139
--------	-------------------	-----	----	------	--------------	--------------

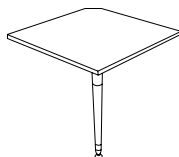

90° Corner - Rounded Corners

Connects to 30" Deep Rectangular Tables. Includes (1) Tapered leg. *Not available with Spider Legs*.

B30SPLEG	25 x 6 x 28	150	16	2.90	\$284	
----------	-------------	-----	----	------	--------------	--



Spider Legs for 30"D Tables

Spider leg with levers. Shipped/sold one per carton. **Tops sold separately.**

- Available in Silver - **SI** or Black - **BK**. Please specify.
- **To be used with 30"D tops only**

Required Specifications

Top Finish
Top / Edge Detail

Optional Specifications

Grommet
Filler Modesty Panel (Wedge Tops only)
Modesty Panel (Rectangular Return Tops)
High Pressure Laminate

Accessories

Power Block
Villa Power Block (Corded)

B BUNGEE SL™

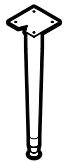
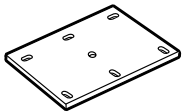
	MODEL#	DIMENSIONS	FREIGHT CLASS	WT/LBS.	CUBIC FT.	LIST PRICE	HP ADD
 <p>Spider Legs for 20" & 24" D Tables</p>		D x W x H					
	B2XSPLEG	20 x 6 x 28	125	14	2.20	\$244	
<p>Spider leg with levellers. Shipped/sold one per carton. Tops sold separately.</p> <ul style="list-style-type: none"> • Available in Silver - SI or Black - BK. Please specify. • To be used with 24" & 24" deep tops only 							
 <p>Tapered Leg</p>							
	B29TPLEG	6 x 6 x 28	85	11	.80	\$115	
<p>Tapered leg with levellers for tables of all depths. Shipped/sold one per carton. Tops sold separately.</p> <ul style="list-style-type: none"> • Available in Silver - SI or Black - BK. Please specify. 							
 <p>Flat Bracket</p>							
	B6PLT	4.5 x 3 x .125	70	2	.10	\$37	
<p>To be used as a mending plate for Bungee SL. Black only. Shipped/sold one per pack.</p>							

Required Specifications

Leg Finish

GENERAL INFORMATION

- Power and Data Management Troughs for the **BUNGEE SL** table series. Add Global's proprietary 4-wire power kits and create inexpensive and versatile training, benching, academic and meeting areas.
- Front panels are available in Laminate or Aluminum. A center spine version allows for inexpensive double-sided applications.
- **POWER AND DATA MANAGEMENT TROUGHS** are sold separately and are meant to be used on **BUNGEE SL only**.
- **POWER AND DATA MANAGEMENT TROUGHS** accept Global's 4-wire power kit in addition to numerous data, phone and other multimedia wires.
- Filler modesty panels conceal wiring in spaces not covered by troughs.
- Global laminate and seating products are in compliance with stringent emission guidelines set out by UL/Greenguard Environmental Institute under the standards for low emitting products and materials. www.greenguard.org
- **Level 3 Certified**

FINISHES

Laminate:

ACJ	Absolute Acajou	ASN	Asian Night
AWC	Avant Cherry	AWH	Avant Honey
BLK	Black	BRC	Brushed Cobalt
CSJ	Constellation Java	DES	Dark Espresso
HGT	Hayden Grey (Taupe)	QTM	Quartered Mahogany
SKC	Shaker Cherry	SOG	Storm Grey
TFW	Tiger Fruitwood	TMA	Tiger Mahogany
TMP	Tiger Maple	TWL	Tiger Walnut
WHT	White	WHC	White Chocolate
WGY	Willow Grey	WCR	Winter Cherry

Aluminum Face Panel, Trough, Filler Panels and End Caps:

Black - BK Silver - SI

LAMINATE FACE PANEL (LFP)

- Laminate face panel (LFP) on the approach side is 11/16" thick. LFP height is 13".
- Rear access panel is ¼" thick laminate. Rear panel height is 7.25".
- LFP and rear panel swing up to allow wire access and feature a flexible sweep at the top.
- All laminate components are made of 45 lb. commercial density particle board, covered on both sides with high performance, thermally fused laminate.
- The trough portion of the unit is made of a heavy duty aluminum extrusion to allow wire systems (including Global's 4-Wire System) to lie within the bottom.
- LFP is available in all standard laminates, aluminum trough available in Silver (**SI**) or Black (**BK**) finish, please specify (rear access panel is finished in Brushed Cobalt (**BRC**) laminate when SI is specified, or Black (**BLK**) laminate when BK is specified).
- End Caps (JBEC) sold separately

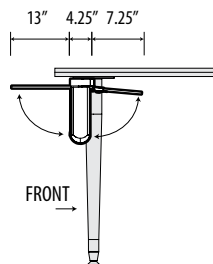

Tops, legs and end caps not included

ALUMINUM FACE PANEL (AFP)

- Aluminum face panel (AFP) is an aluminum extrusion. AFP height is 8.25".
- AFP swings down to allow wire access and features a flexible sweep at the top.
- Rear access panel is ¼" thick laminate. Rear panel height is 7.25".
- Rear panel swings up to allow wire access and features a flexible sweep at the top.
- The trough portion of the unit is made of a heavy duty aluminum extrusion to allow wire systems (including Global's 4-Wire System) to lie within the bottom.
- AFP and aluminum trough available in Silver (**SI**) or Black (**BK**) finish, please specify (rear access panel is finished in Brushed Cobalt (**BRC**) laminate when SI is specified, or Black (**BLK**) laminate when BK is specified).
- End Caps (JBEC) sold separately.

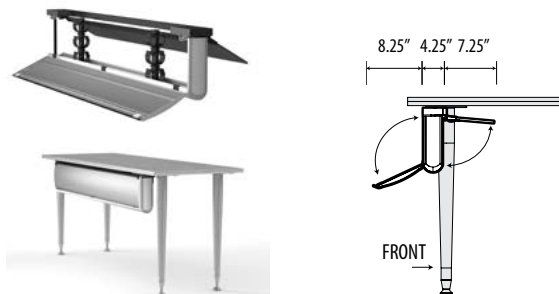

Tops, legs and end caps not included

CENTER SPINE (CS)

- ¼" thick laminate panels on both sides of the unit. Panel height is 7.25".
- Both panels swing up to allow wire access and feature a flexible sweep at the top.
- All laminate components are made of 45 lb. commercial density particle board, covered on both sides with high performance, thermally fused laminate.
- The trough portion of the unit is made of a heavy duty aluminum extrusion to allow wire systems (like Global's 4-Wire System) to lie within the bottom.
- Aluminum trough available in Silver (**SI**) or Black (**BK**) finish, please specify (rear access panel is finished in Brushed Cobalt (**BRC**) laminate when SI is specified, or both access panels are finished in Black (**BLK**) laminate when BK is specified).
- End Caps (JBEC) sold separately.



Tops, legs and end caps not included

B BUNGEE SL™ POWER/DATA MANAGEMENT TROUGHS - NOTES

FILLER MODESTY PANELS

- Used to fill the space between two power and data management troughs and conceal wiring from the approach side
- Straight Filler allows for use in straight configurations between two rectangular tables with power and data management troughs
- Curved Filler allows for use at curve with 90° wedge tables between two rectangular tables with power and data management troughs
- Available in Silver (**SI**) or Black (**BK**) finish. Please specify.

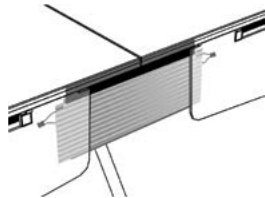

Straight Filler Modesty Panel

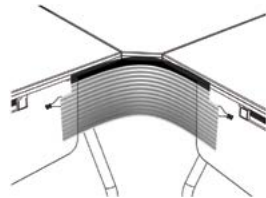

Curved Filler Modesty Panel

END CAPS

- Plastic end caps with decorative insert. Required for beginning and end of runs.
- Cap can be notched in field to allow wire infeed pass through.
- Available in Silver (**SI**) or Black (**BK**) finish. Please specify.



WIRE MANAGEMENT

- Two wire manager clamps are included within all power and data management troughs.
- Attached to the unit, they can slide from side to side to accommodate wiring systems
- Data, voice, multi-media and power can be routed separately using channels on each wire manager.
- Additional wire manager clamps are available to retrofit.
- Available in black only.

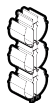

GLOBAL 4-WIRE POWER SYSTEM

- Global's proprietary power system comes with everything you need to power your **BUNGEE SL** layouts. Kits coordinate to the size of the table being used and fit snugly into the bottom of the power and data management trough.
- Single duplex kits come with one duplex – centered on the wiring harness. Duplexes are 6" wide.
- Double duplex kits come with two duplexes – 11" of wiring on each side of the harness allows for flexibility between connections. Duplexes are 6" wide.
- One end of the harness kit features a female connection, while the opposite end features a male connection for a quick and easy connect/disconnect
- Actual kit length is 1" longer than nominal
- Must be hardwired using infeeds (specified separately) by a licensed electrician
- All conduits are enclosed in a black nylon sleeve to reduce visibility
- All duplexes and connectors are plastic. Black only.
- **8 DUPLEXES PER CIRCUIT MAXIMUM** – maximums are to National Electric Code (NEC) – some local codes vary from NEC code – it is the customer's responsibility to follow all applicable local codes and guidelines.

ELECTRICAL SYSTEM

- 4-2 Wiring Schematic
- 4-Wire Shared Neutral
- Complies with National Electric Code
- UL Listed
- All circuits rated for 20 AMP

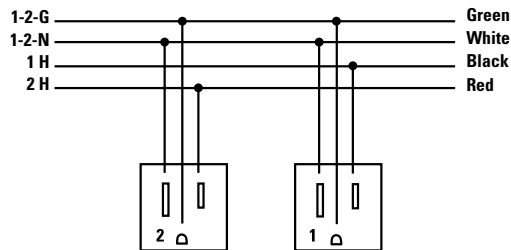

PRODUCT

MAX UNITS PER CIRCUIT

P42S	8 units per circuit
P42D	4 units per circuit

POWER/DATA MANAGEMENT TROUGH PLACEMENT

Single Table - AFP or LFP

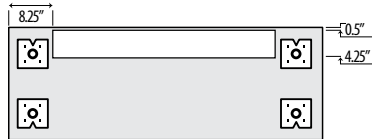

Shared Leg Tables - AFP or LFP

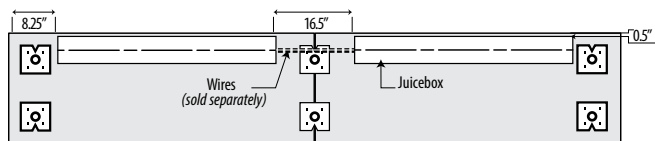

AFP or LFP

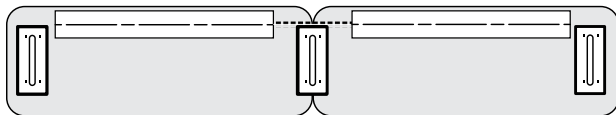

CS

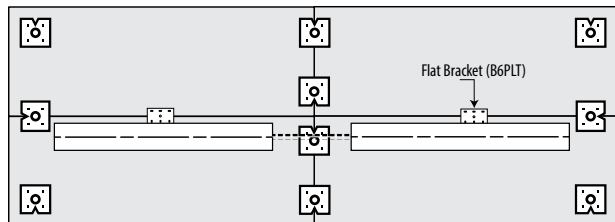

CS

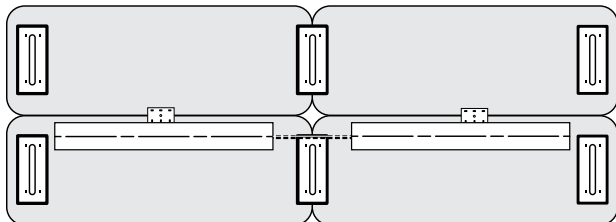

GLOBAL 4-WIRE POWER TO POWER/DATA MANAGEMENT TROUGH:

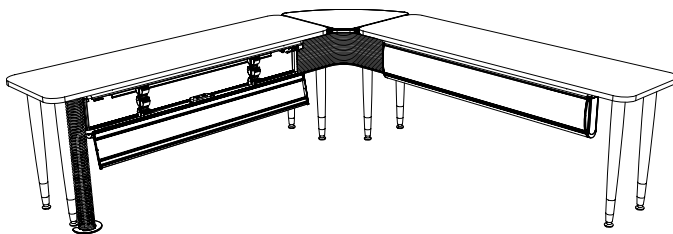

Bungee SL with AFP Power/Data Management Trough - 90° Corner Application

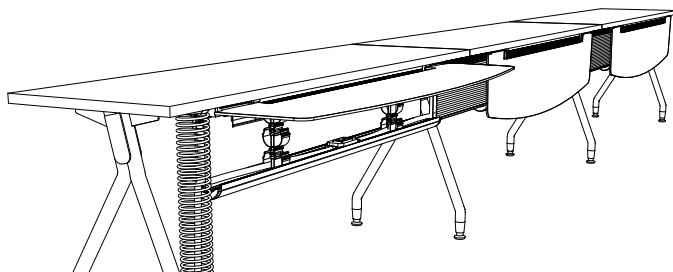

Bungee SL with LFP Power/Data Management Trough - Single Sided Straight Run



Bungee SL with CS Power/Data Management Trough - Back to Back Application (shown with power snake)

UTILIZING POWER BLOCKS AND GROMMETS WITH POWER/DATA MANAGEMENT TROUGH

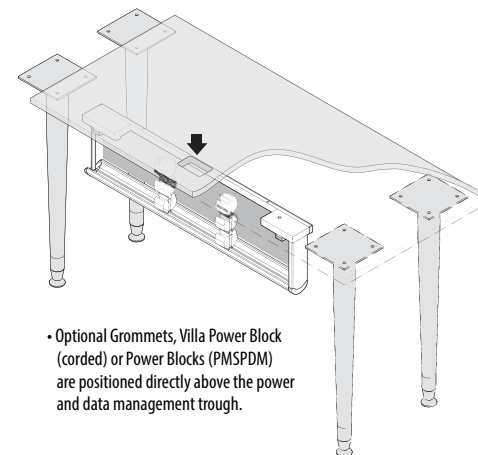

• Optional Grommets, Villa Power Block (corded) or Power Blocks (PMSPDM) are positioned directly above the power and data management trough.

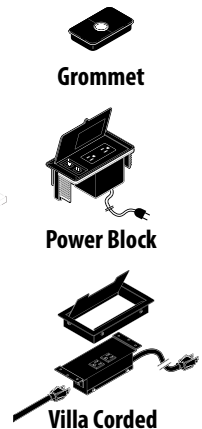

B BUNGEE SL™ POWER/DATA MANAGEMENT TROUGHS

MODEL#	DIMENSIONS D x W x H	FREIGHT CLASS	WT/LBS.	CUBIC FT.	LIST PRICE	HP ADD
JB72L	4.25 x 55.75 x 10	125	23	2.90	\$606	
JB60L	4.25 x 43.75 x 10	125	18	2.30	\$542	
JB48L	4.25 x 31.75 x 10	100	14	1.70	\$471	
JB42L	4.25 x 25.75 x 10	100	12	1.50	\$436	
JB36L	4.25 x 19.75 x 10	100	10	1.20	\$400	

Trough w/Laminate Face Panel (LFP)

For use on rectangular Bungee SL surfaces only. Out-facing laminate panel swings up to allow wire access and features flexible sweep at the top. In-facing laminate panel swings up to allow wire access and features flexible sweep at the top. Black wire management clamps included.

- To fill the gap between two power/data management trough (LFP) modules in a straight run, a single filler modesty panel (JBFSFM) is recommended.
- To fill the gap between two power/data management trough (LFP) modules at 90°, a corner filler modesty panel (JBCFM) is recommended.
- Model # corresponds to the size table power/data management trough will fit on (i.e. JB72L will fit a 72" wide table).



Trough w/Aluminum Face Panel (AFP)

For use on rectangular Bungee SL surfaces only. Out-facing aluminum panel swings down to allow wire access and features flexible sweep at the top. In-facing laminate panel swings up to allow wire access and features flexible sweep at the top. Black wire management clamps included.

- To fill the gap between two power/data management trough (AFP) modules in a straight run, a single filler modesty panel (JBFSFM) is recommended.
- To fill the gap between two power/data management trough (AFP) modules at 90°, a corner filler modesty panel (JBCFM) is recommended.
- Model # corresponds to the size table power/data management trough will fit on (i.e. JB72A will fit a 72" wide table).

JB72A	4.25 x 55.75 x 10	100	21	2.20	\$630	
JB60A	4.25 x 43.75 x 10	100	17	1.80	\$575	
JB48A	4.25 x 31.75 x 10	92.5	13	1.30	\$504	
JB42A	4.25 x 25.75 x 10	92.5	11	1.10	\$469	
JB36A	4.25 x 19.75 x 10	60	9	.08	\$433	



Trough w/Center Spine (CS)

For use on rectangular Bungee SL surfaces only in back-to-back applications only. Two laminate panels swing up to allow wire access and feature flexible sweep at the top. Black wire management clamps included.

- To fill the gap between two power/data management trough (CS) modules in a straight run, two filler modesty panels (JBFSFM) are recommended to conceal wiring from both sides.
- Model # corresponds to the size table power/data management trough will fit on (i.e. JB72C will fit a 72" wide table).

JB72C	4.25 x 55.75 x 10	100	19	2.20	\$547	
JB60C	4.25 x 43.75 x 10	100	15	1.80	\$515	
JB48C	4.25 x 31.75 x 10	100	12	1.30	\$435	
JB42C	4.25 x 25.75 x 10	100	10	1.10	\$405	
JB36C	4.25 x 19.75 x 10	60	8	.08	\$375	



Straight Filler Modesty Panel

Straight filler modesty is used to fill the space between two power/data management trough modules where tables are linked in a straight configuration.

- In center spine applications, two straight filler modesty panels should be specified to cover cabling and wires from both sides.
- Filler modesty panels are reversible with Black (BK) finish on one side and Silver (SI) finish on the opposite side.

JBFSFM	0.25 x 22.5 x 9	70	1.60	.04	\$131	
--------	-----------------	----	------	-----	--------------	--

Required Specifications

Laminate face panel finish (LFP)
Aluminum face panel finish (AFP)
Power/Data Trough finish
Filler Modesty Panel finish.

Optional Specifications

4-Wire Power System

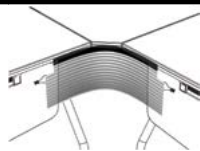

Curved Filler Modesty Panel

MODEL#	DIMENSIONS	FREIGHT CLASS	WT/LBS.	CUBIC FT.	LIST PRICE	HP ADD
JBCFM	D x W x H 0.25 x 22.5 x 9	70	1.80	.05	\$156	

Curved filler modesty is used to fill the space between two power/data management troughs where tables are linked at a 90° curve.

- For interior curves only.
- Filler modesty panels are reversible with Black (BK) finish on one side and Silver (SI) finish on the opposite side.



End Cap

JBEC	3 x 8 x 1	70	1	.15	\$31	
------	-----------	----	---	-----	-------------	--

Plastic end cap to be snapped into place at the end of power/data management troughs. To be specified for the beginning and end of runs for a finished look.

- Plastic cap can be notched in the field to allow infeed or data cable pass-through.

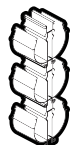

Wire Management Clamp

JBWM2	2.5 x 6 x 1.75	70	1	.01	\$117	
-------	----------------	----	---	-----	--------------	--

Wire management track with double wire clamp - triple height. Can be affixed to the underside of worksurface using double-sided tape (supplied) or retrofit into power/data management trough modules. Black finish only.

- Recommended for use at 90° corners.
- Retrofitting requires disassembly of power/data management trough modules.

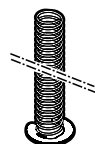

Power Snake

JBPS	4 x 4 x 34	100	2	.25	\$71	
------	------------	-----	---	-----	-------------	--

Attaches to the underside of worksurface with supplied wood screws. Used to organize and channel wires from the power/data management trough down to the floor infeed. Black finish only.

4-WIRE POWER SYSTEM

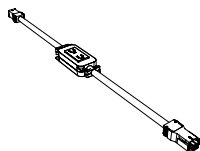

Single Duplex Kit

P42S-72	73 x 2 x 2	60	3.19	.10	\$145	
P42S-60	61 x 2 x 2	60	2.82	.09	\$133	
P42S-48	49 x 2 x 2	60	2.44	.08	\$122	
P42S-42	43 x 2 x 2	60	2.26	.07	\$116	
P42S-36	37 x 2 x 2	60	2.07	.06	\$110	

Single Duplex Kit includes one black plastic duplex connected to harnesses. Male connection (IN) on one side with female connection (OUT) on the opposite for easy connect and disconnect. Conduit is wrapped in black nylon sleeve. Actual length is 1" longer than nominal.

- Specify Circuit 1 or Circuit 2
- Model # corresponds to the size table power/data management trough will fit on (i.e. P42S-48 will fit a JB48A, JB48L or JB48C module).
- Infeed required for connection to building power. Sold separately (next page)

Required Specifications

End cap finish
Circuit 1 or Circuit 2 (duplex kits)

B BUNGEE SL™ POWER/DATA MANAGEMENT TROUGHS

4-WIRE POWER SYSTEM

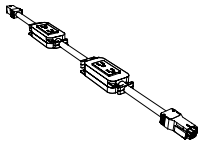

Double Duplex Kit

MODEL#	DIMENSIONS D x W x H	FREIGHT CLASS	WT./LBS.	CUBIC FT.	LIST PRICE
P42D-72	73 x 2 x 2	60	3.01	.10	\$168
P42D-60	61 x 2 x 2	65	2.63	.09	\$156
P42D-48	49 x 2 x 2	65	2.26	.08	\$144
P42D-42	43 x 2 x 2	65	2.07	.07	\$139
P42D-36	37 x 2 x 2	70	1.88	.06	\$133

Double Duplex Kit includes two black plastic duplexes connected to harnesses. Male connection (IN) on one side with female connection (OUT) on the opposite for easy connect and disconnect. Conduit is wrapped in black nylon sleeve. Actual length is 1" longer than nominal.

- Specify Circuit 1 or Circuit 2. Both duplexes on the kit will be assigned to the same circuit.
- Model # corresponds to the size table power/data management trough will fit on (i.e. P42D-48 will fit a JB48A, JB48L or JB48C module).
- Infeed required for connection to building power. Sold separately (below).

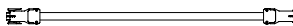

Power Harness Jumper

P42J-72	73 x 2 x 2	60	3	.10	\$131
P42J-60	61 x 2 x 2	60	2.73	.09	\$117
P42J-48	49 x 2 x 2	65	2.35	.08	\$103
P42J-42	43 x 2 x 2	60	2.16	.07	\$96
P42J-36	37 x 2 x 2	70	1.98	.06	\$89
P42J-18	19 x 2 x 2	70	1.41	.04	\$68

Male connection (IN) on one side with female connection (OUT) on the opposite for easy connect and disconnect. Conduit is wrapped in black nylon sleeve. Actual length is 1" longer than nominal.

- Use P42J-18 between two power/data management troughs separated by Bungee SL wedge, keystone or half moon tables
- Use all other sizes to jump between power kits on power/data management troughs that are NOT powered (i.e. use a P42J-60 as a pass-through on a 60" wide non-powered table between POWERED power/data management trough modules.

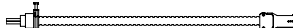

72" Multi-circuit Hardwire Infeed

P42HW-72	72 x 1 x 1	70	6.50	.30	\$143
----------	------------	----	------	-----	--------------

72" Multi-circuit Hardwire Infeed (up to 20 AMPS per circuit), two circuits. Provides single power entry from floor or wall located building power supply. Conduit is wrapped in black nylon sleeve.

- Connects P42S or P42D kits
- **TO BE HARDWIRED BY LICENSED ELECTRICIAN.** UL listed.
- Where Liquid Tight conduit is required, specify P42HW-72L

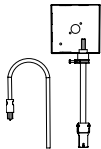

Single-circuit 3-Prong Infeed

P42TP-120	8 x 4 x 2	70	6.10	.30	\$178
P42TP-72	8 x 4 x 4	60	4.50	.15	\$163

Hardwire junction box included (to be mounted on underside of table). Provides single power entry from floor or wall located building power supply. Conduit is wrapped in black nylon sleeve. Allows for quick and easy disconnection from the wall. Available in 72" or 120" overall lengths.

- Connects P42S or P42D kits. **Power circuit 1 only.**
- **TO BE HARDWIRED BY LICENSED ELECTRICIAN.** UL listed.

Required Specifications

Face panel and box finish - BLK or TUN

POWER BLOCK

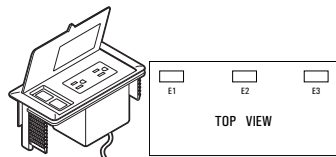

Power/Data Block

MODEL#	DIMENSIONS	FREIGHT CLASS	WT/LBS.	CUBIC FT.	LIST PRICE
	D x W x H				
PMSPDM	3.5 x 6.5 x 2.75	70	2	.10	\$238

Worksurface power and data module. Two power receptacles and two data receptacles. 9' cord. Specify position and **add \$65** for cutout in worksurface. See diagram E1/E2/E3 for specification location. Black (**BLK**) only.

VILLA I SERIES CORDED UNITS

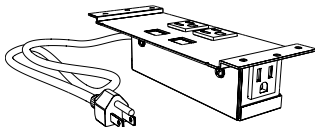

Data Knockouts, No Data Ports

VIL-C-DKO-_-108	3.25 x 8.75 x 2.25	100	4	.45	\$186
VIL-C-DKO-_-72	3.25 x 8.75 x 2.25	100	4	.45	\$186

Villa I with 3-prong plug. Includes **two power receptacles** and two knockouts for data. A third convenience receptacle is provided below the worksurface. **V1, V2 or V3 cutout(s) must be specified on training table** (see product notes section for more details and cutout upcharge). **Grommet cover is required and sold separate** (see below). UL/CUL listed.

- Replace _ with **B** for **Black**
- Replace _ with **S** for **Silver Pearl**

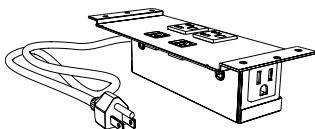

Data Knockouts, Data Ports Included

VIL-C-D-_-108	3.25 x 8.75 x 2.25	100	4	.45	\$301
VIL-C-D-_-72	3.25 x 8.75 x 2.25	100	4	.45	\$301

Villa I with 3-prong plug. Includes **two power receptacles** and **two RJ45 Cat 6** data. A third convenience receptacle is provided below the worksurface. **V1, V2 or V3 cutout(s) must be specified on training table** (see product notes section for more details and cutout upcharge). **Grommet cover is required and sold separate** (see below). UL/CUL listed.

- Replace _ with **B** for **Black**
- Replace _ with **S** for **Silver Pearl**

VILLA GROMMET COVERS

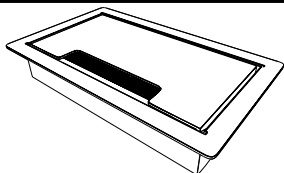

Villa Grommet Cover

VIL-GROM-F-_-	3.5 x 5.75 x .94	70	1	.08	\$93
---------------	------------------	----	---	-----	-------------

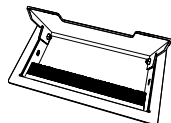

Powder coated flush metal grommet to be used with Villa I **corded** series power blocks. Cutouts in tables must be specified separately. **V1, V2 or V3 cutout(s) must be specified on training table** (see product notes section for more details and cutout upcharge). **Grommet cover remains open while in use.**

- **Cannot be used with PMSPDM.**
- Replace _ with **B** for **Black**
- Replace _ with **S** for **Silver Pearl**

Required Specifications

Face panel and box finish



ConnectTABLES® provides solutions for a variety of day-to-day work environments. Designed as easy-to-use linking or freestanding tables, ConnectTABLES is limited only by your imagination.

Open Conference

Many ConnectTABLES® tops can be assembled to be freestanding. When combined with locking casters and the flip top “T” leg, the result is easy storage and complete portability.

Meeting Rooms

ConnectTABLES® modular units will provide quick and affordable answers for all sizes and shapes of rooms and applications.

Educational and Training Rooms

ConnectTABLES® table tops configure easily into temporary or permanent educational applications.



Features and Benefits

- Optional, easy-to-use thumbscrews allow installation without tools.
- Optional zinc-plated steel ganging hardware connects free standing tops without moving “T” Leg position.
- Optional modesty panel wire management unit available.
- Casters will not affect table height when used in conjunction with or in place of glides.
- Optional Black grommets for convenient wire management can be ordered “factory installed”.
- Tops are 1” thick and constructed of 45 lb. density particleboard.
- Optional casters available with or without manual locks provide mobility.
- ConnectTABLES® tops are available in all Global laminate finishes with three leg and two edge color options.



T Leg with leveling glides



Modesty Panel

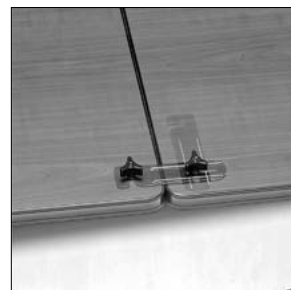

Optional ganging connector

GENERAL INFORMATION

- ConnecTABLES® is an affordable and highly flexible system of modular tables. Designed as easy-to-use linking or freestanding tables, ConnecTABLES adapts to most every requirement: seminar or training room, meeting room, personal workstations, educational, conferencing and team cluster workgroups.
- ConnecTABLES have nine basic top shapes available in various sizes.
- ConnecTABLES edges **do not match** any other Global product in either color or style.
- Global laminate and seating products are in compliance with stringent emission guidelines set out by the Greenguard Environmental Institute under the standards for low emitting products and materials. www.greenguard.org
- **Level 2 Certified**

WORKSURFACES

- Tops are 1" thick, made of 45 lb. density particle board covered on both sides with high performance thermally fused laminate.
- Laminate finishes are available in High Pressure. Contact your Customer Service Representative for a quote.
- If other than a Global standard laminate finish is preferred, contact your Customer Service Representative. Information needed includes the name of the laminate manufacturer, color name, number and model of table. You will then be given a quote for this special order.
- **ConnecTABLES® edges do not match any other Global product in either color or style.**

CONSTRUCTION

- Some components can stand alone when the "T" base is set in the freestanding position. When the "T" base is in the linking position, all the components can be used in grouping configurations (clusters).
- Optional wire grommets not available on 45° wedge and the 60° triangle.
- Rectangular tops 54" in length and longer are supplied with a 16" gauge steel support channel. Top is pre-drilled for placement.
- Shipped RTA (ready to assemble). Quick and easy to assemble.
- Special width tops are available. Use next size up.
- Tables adjust from 28 3/4" to 29 3/4" high.
- Elliptical column cover, glides, casters, thumbscrews and endcaps available in Black only.
- Must specify top, edge, and "T" base color with each order.

LEGS

- "T" leg is coated with environmentally friendly, recyclable paint electrostatically applied epoxy powder coating for a very durable finish in three colors as specified below. Only the bottom horizontal portion of the painted leg is visible.
- Black plastic leveling glides offer 1" adjustability.
- Two black plastic elliptical column caps cover each leg column.
- Casters will not affect table height when used in conjunction with or in place of glides.
- Casters can facilitate mobility in installations which need to be moved frequently.

LAMINATE FINISHES

ACJ	Absolute Acajou	ASN	Asian Night
AWC	Avant Cherry	AWH	Avant Honey
BLK	Black	BRC	Brushed Cobalt
CSJ	Constellation Java	DES	Dark Espresso
GRY	Grey	HGT	Hayden Grey
QTM	Quartered Mahogany	SKC	Shaker Cherry
SOG	Storm Grey	TFW	Tiger Fruitwood
TMA	Tiger Mahogany	TMP	Tiger Maple
TWL	Tiger Walnut	WHT	White
WHC	White Chocolate*	WGY	Willow Grey
WCR	Winter Cherry		

*textured

EDGE COLORS

Black (BK) Grey (GR)

LEG COLORS

Black (BK) Grey (GR) Chrome (CH)

GROMMETS

- Optional Grommets available in standard workspace locations (left, center or right) for Rectangular Tables. Order as: **AG1, AG2 or AG3.....Add \$65**
- Grommet hole dimensions are 3 1/4" wide x 1 7/8" deep.

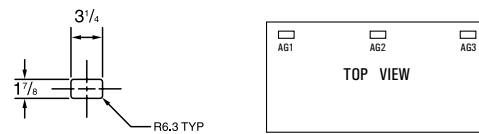

- Grommets may be placed at non-standard locations. Order as: **AGS - ADD \$65.00** A drawing must be supplied with vertical and horizontal dimensions to the center of the cut-out (as in drawing above). Please refer to CUSTOM GROMMET LOCATION FORM in the back reference section.

POWER BLOCK

- A Power Block (model **PMSPDM**) may be ordered on all worksurfaces.
- A Power Block is a rectangular workspace power/data module with one electrical duplex receptacle and two data (RJ45) receptacles. 9' black cord included. Power Block dimensions are 3 1/2" deep x 6 1/2" wide x 2 3/4" high.
- To purchase a Power Block, you must specify both the Power Block cut-out location and the Power Block model #. Order Power Block as **PMSPDM, ADD \$238**. Power Blocks are available in standard workspace locations (left, center or right). Order as **E1, E2 or E3. ADD \$65.00**.



Power Block **PMSPDM, Add \$238** Specify location **E1, E2 or E3, Add \$65**

EXAMPLES OF GROMMET AND POWER BLOCK POSITIONS

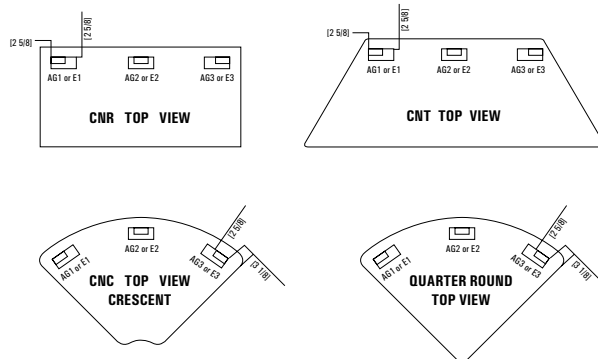

C CONNECTABLES® - NOTES

VILLA CUTOUTS

- Optional Villa cutout available in standard worksurface locations (left, center or right) for **Rectangular Tables**. Order as: **V1, V2 or V3.....Add \$65 for each cutout.**
- Villa cutouts may be placed at non-standard locations. Please contact customer service.
- **Villa is only available on Bungee, Junction and Connectables series**

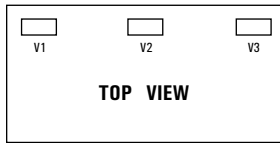

TOP & EDGE OPTIONS

- ConnectTABLES® have nine basic top shapes available in various sizes. All top shapes have a variety of straight or curved edges which are referred to as **Working (W), Connecting (C) or End (E) edges**. Edges can also have a combination of edge types as shown.
- *cannot freestand

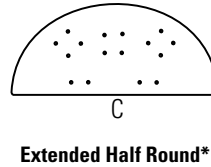
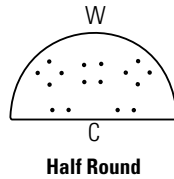
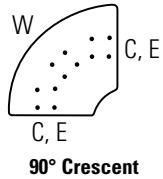
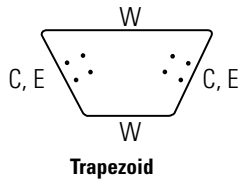
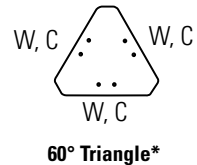
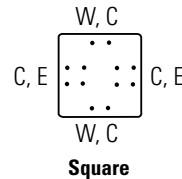
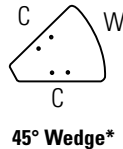
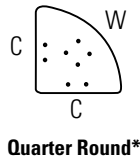
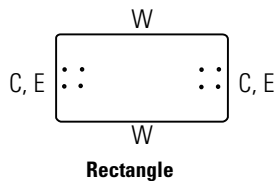

Working Edge (1) - Edges designated with the letter "W" indicate that this is a **working** or sitting edge. These edges can be connected with optional ganging hardware in free-standing applications.

Connecting Edge (2) - Edges designated with the letter "C" indicate that this is a **connecting** edge. These edges can be connected to any other connecting edge of equal width, regardless of the top shape or size.

End Edge (3) - Edges designated with the letter "E" indicate that this is an **end** edge or an edge that can finish a run of tops. If a top has two end edges it can be freestanding. 90° crescent tops can be freestanding if the optional center leg is added.

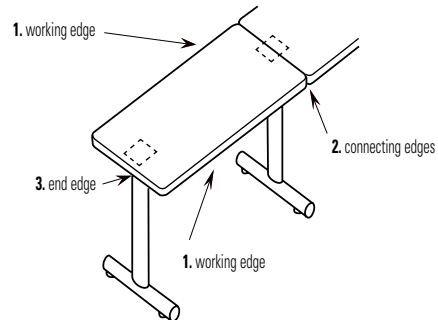

FREESTANDING AND CONNECTING CONDITIONS

Freestanding tables are defined as any one worksurface supported by two or more legs;

connecting tables are defined as more than one work surface supported by a single leg at each point of connection. The rule for determining the quantity of legs of an open configuration is the number of worksurfaces plus one (**See Figure 1**).

On closed configurations, the number of legs is equal to the number of worksurfaces (**See Figure 2**). There are some exceptions, such as when optional third legs are used on quarter round or 90° crescent shapes.

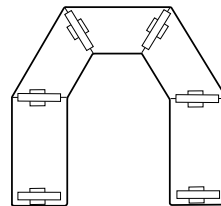

Figure 1. Open Configuration
Number of Surfaces = 5
Number of Legs = 6

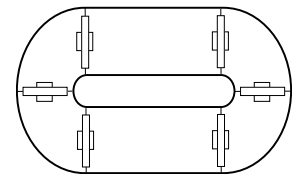

Figure 2. Closed Configuration
Number of Surfaces = 6
Number of Legs = 6

FREESTANDING CONDITIONS

- All square, rectangle and trapezoid shapes are able to act as freestanding tables (**Figure 3**).
- When Trapezoid tops are freestanding, legs must be on the outer left and right sides (**Figure 4**).
- 90° crescent work surfaces have provision for an optional third center leg for additional stability when heavy loads are applied to the outside edge. They can also be used as freestanding tables when a third leg is added (**Figure 5**).
- All freestanding tables can be connected with optional ganging hardware.
- Freestanding tables can be ganged with connected tables in some cases, providing that the number and size of connected tables is easily movable (**Figure 6**).
- **DO NOT DRAG TABLES WHEN RE-CONFIGURING.**

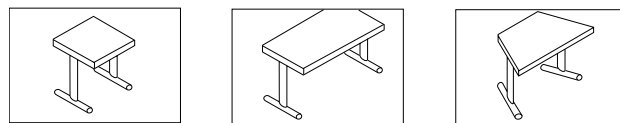

Figure 3 - Freestanding Tables

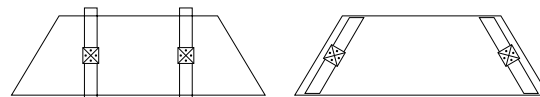

Figure 4 - Trapezoid Tops

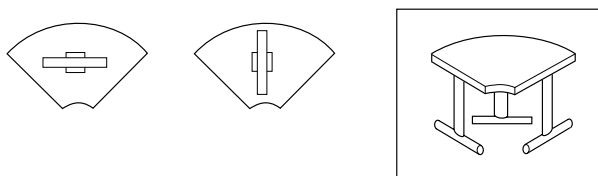

Figure 5 - Adding a Third Leg

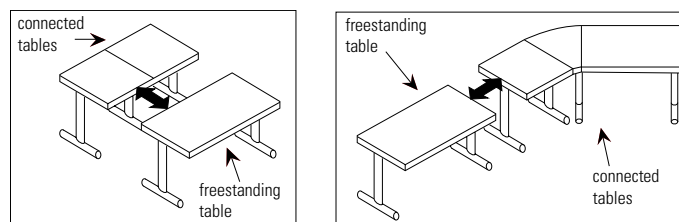

Figure 6 - Ganging with Connected Tables

CONNECTING CONDITIONS

- Any two worksurfaces of equal depth (24"D, 30"D or 36"D) can be connected with one leg, at the connecting or end edges (**Figure 8**).
- Half round work surfaces can be used in the following ways: They must be of equal width when connected to each other (**Figure 7**) or the connecting shapes must be equal to half the width of the connecting half round (**Figure 8**).
- ConnectABLES® is designed with the leg to be fastened parallel to connecting edges, but in some cases you may wish to fasten legs at 90° to connecting edges. This could allow for increased leg or knee clearance, depending on the intended use (**Figure 9**).
- Quarter round and 90° crescent work surfaces have provision for an optional third leg for additional stability when heavy loads are applied to the outside edge. For quarter round work surfaces, it is recommended that configuration "A" be used since the outside end of the center leg in configuration "B" is almost flush with the outside edge of the worksurface. If configuration "B" is installed against a wall or where there will be no traffic flow, then configuration "B" can be used.

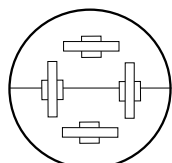

Figure 7

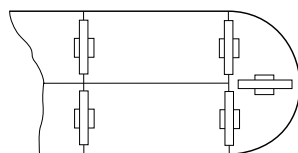

Figure 8

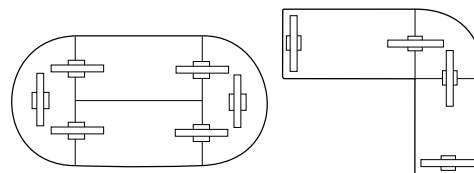
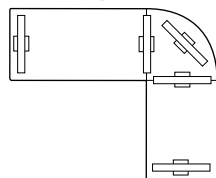
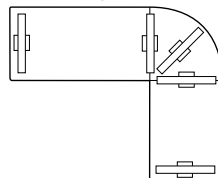

Figure 9 - 90° Leg Connections



Configuration A



Configuration B

C CONNECTABLES® - PUTTING IT ALL TOGETHER

Legs are fastened to work surfaces utilizing a steel-to-steel connection. Each leg comes equipped with four ¼" x 7/8" machine screws. Screws are inserted through the four oval shaped holes only. Do not use wood screws! When fastening legs to work surfaces, hand thread screws into position to prevent any cross threading. When all screws have been hand threaded, tighten firmly with screwdriver to secure. Optional thumbscrews can be used in place of machine screws. Thumbscrews eliminate the need for a screwdriver, whether assembling or disassembling tables. **Do not use power tools for assembly of legs.**

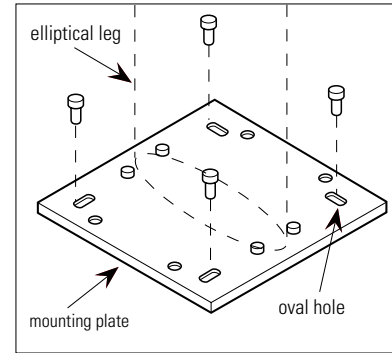

FREESTANDING TABLES

1. Turn work surface upside-down on clean floor. (You may want to use carton from packaging as a protective assembly surface to protect the top from scratching.)
2. Position leg mounting plate holes over threaded steel inserts in top.
3. Fasten each leg to top with four ¼" x 7/8" screws.
4. Turn table right-side up.
5. Level table by adjusting glides.

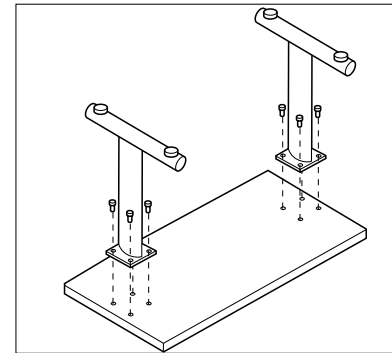

CONNECTING TABLES

1. Determine approximate location of desired configuration in room and turn work surfaces upside-down on floor. (Remember you are working in reverse.)
2. Position leg mounting plate so it is centered over the connecting edge of the first work surface. Fasten leg with two ¼" x 7/8" screws.
3. Repeat step 2 and 3 on the opposite edge of the first work surface.
4. Turn table right-side up.
5. Turn table right-side up and fasten to the previous top from the underside.
6. To add additional work surfaces repeat step 6.
7. When all the tops have been connected, level complete configuration by adjusting glides.

Note: Use the same procedures as above when using optional thumb screws.

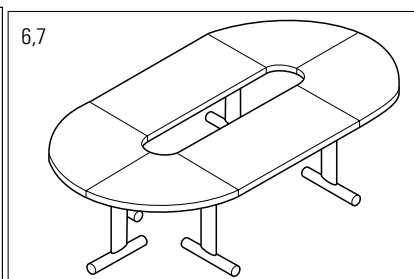
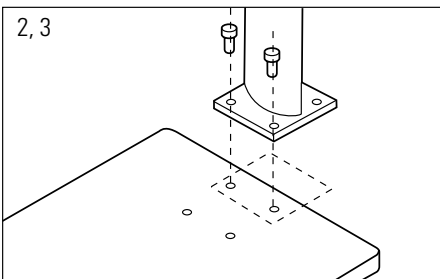
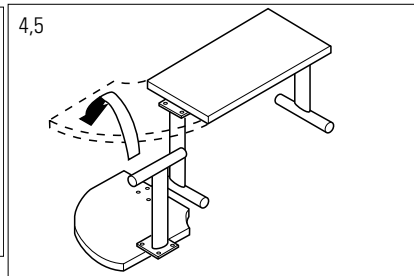
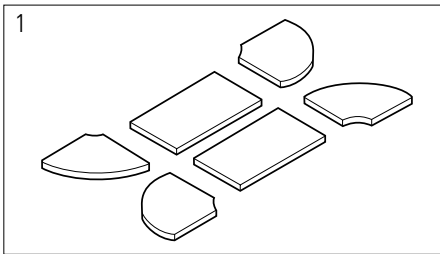

OPTIONAL CASTERS

1. Turn work surface upside-down on floor.
2. Remove existing glide if previously installed.
3. Fasten caster to T-leg by threading caster stem into base of T-leg and secure by tightening lock nut.
4. If casters are used in combination with gliders, level table by adjusting glides.

Note: Casters are available in locking or non-locking styles.

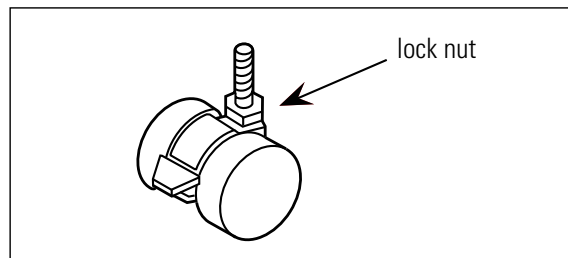
**OPTIONAL GANGING HARDWARE**

1. Optional ganging hardware should be used when quick and frequent reconfigurations are required.
2. Turn work surfaces to be ganged upside-down on floor.
3. Remove ganging hardware from package. Holes with steel inserts are located in the corner of tops.
4. Fasten ganging hardware to each work surface with supplied thumb screws.
5. Projected arm from ganging hardware can pivot out of the way when not in use.

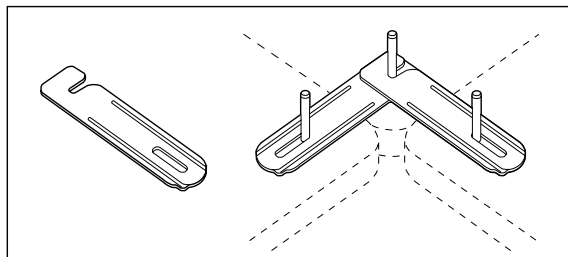

SQUARE TOPS

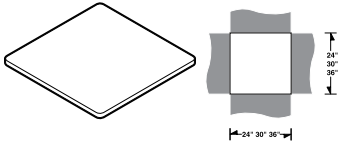

Square Top

MODEL#	DIMENSIONS	FREIGHT CLASS	WT./LBS.	CUBIC FT.	LIST PRICE
--------	------------	---------------	----------	-----------	------------

D x W x H

CNS2424	24 x 24 x 1.12	70	18	1	\$286
CNS3030	30 x 30 x 1.12	70	27	1.56	\$350
CNS3636	36 x 36 x 1.12	70	39	2	\$376

T-mold edging. Predrilled with threaded steel inserts for freestanding and linking installations.

RECTANGULAR TOPS

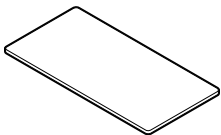
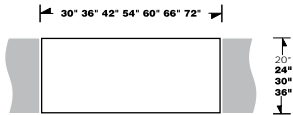

Rectangle Top

CNR2030	20 x 30 x 1.13	70	22	1.25	\$206
CNR2036	20 x 36 x 1.13	60	22.50	.46	\$230
CNR2042	20 x 42 x 1.13	70	31	1.75	\$248
CNR2048	20 x 48 x 1.13	70	35	2	\$276
CNRU2054	20 x 54 x 1.13	60	33.75	.69	\$343
CNRU2060	20 x 60 x 1.13	70	37.50	1.40	\$368
CNRU2066	20 x 66 x 1.13	70	41.25	.84	\$399
CNRU2072	20 x 72 x 1.13	70	45	1	\$425
CNR2430	24 x 30 x 1.12	70	22	1.25	\$206
CNR2436	24 x 36 x 1.12	70	26	1.50	\$230
CNR2442	24 x 42 x 1.12	70	31	1.75	\$248
CNR2448	24 x 48 x 1.12	70	35	2	\$276
CNRU2454	24 x 54 x 1.12	70	42	2.34	\$343
CNRU2460	24 x 60 x 1.12	70	47	2.50	\$368
CNRU2466	24 x 66 x 1.12	70	52	2.80	\$399
CNRU2472	24 x 72 x 1.12	70	57	3	\$425
CNR3036	30 x 36 x 1.12	70	33	1.88	\$276
CNR3042	30 x 42 x 1.12	70	38	2.19	\$300
CNR3048	30 x 48 x 1.13	70	44	2.50	\$317
CNRU3054	30 x 54 x 1.12	70	52	2.80	\$394
CNRU3060	30 x 60 x 1.12	70	59	3.13	\$423
CNRU3066	30 x 66 x 1.12	70	64	3.44	\$451
CNRU3072	30 x 72 x 1.12	70	70	3.75	\$482
CNR3642	36 x 42 x 1.12	60	52.50	1.60	\$399
CNR3648	36 x 48 x 1.12	60	60	1.80	\$435
CNRU3654	36 x 54 x 1.12	60	70	2	\$527
CNRU3660	36 x 60 x 1.12	60	78	2.20	\$585
CNRU3666	36 x 66 x 1.12	60	87	2.40	\$640
CNRU3672	36 x 72 x 1.12	60	94	2.60	\$698

T-mold edging. Predrilled with threaded steel inserts for freestanding and linking installations. **Tops 54" and longer are standard with a 16 gauge steel support channel.**

TRAPEZOID TOPS

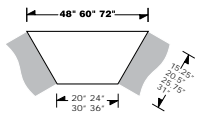

Trapezoid Top

CNT2048	15.25 x 48 x 1.13	65	26.25	.55	\$289
CNT2060	15.25 x 60 x 1.13	65	44	1.85	\$348
CNT2448	20.5 x 48 x 1.12	92.5	21	2	\$289
CNT2460	20.5 x 60 x 1.12	65	44	1.85	\$348
CNT3060	25.75 x 60 x 1.12	92.5	35	3.13	\$381
CNT3072	25.75 x 72 x 1.12	60	66	2.20	\$425
CNT3660	31 x 60 x 1.12	60	66	2.20	\$544
CNT3672	31 x 72 x 1.12	65	79.20	3.50	\$650

T-mold edging. Predrilled with threaded steel inserts for freestanding and linking installations.

Required Specifications

Top Finish
Edge Finish

Optional Specifications

Grommet

Accessories

Power Block

90° CRESCENT TOPS

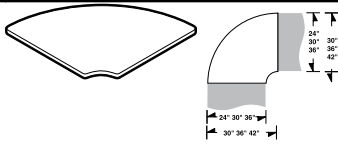

90° Crescent Top

MODEL# DIMENSIONS FREIGHT CLASS WT./LBS. CUBIC FT. LIST PRICE

	D x W x H					
CNC2430	30 x 30 x 1.12	85	20	1.56	\$303	
CNC3036	36 x 36 x 1.12	85	30	2.25	\$432	
CNC3642	42 x 42 x 1.12	70	50	3.15	\$592	

T-mold edging. Predrilled with threaded steel inserts for freestanding and linking installations.

- **CNC2430** for use with 24" deep tops
- **CNC3036** for use with 30" deep tops
- **CNC3642** for use with 36" deep tops
- **CNC2430** does not require a center leg

QUARTER ROUND TOPS

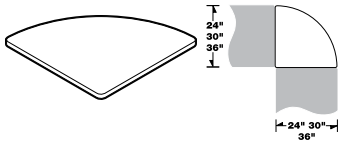

Quarter Round Top

CNQ2424	24 x 24 x 1.12	85	14	1	\$190
CNQ3030	30 x 30 x 1.12	85	21	1.56	\$231
CNQ3636	36 x 36 x 1.12	60	45	1.30	\$328

T-mold edging. Predrilled with threaded steel inserts for **linking installations ONLY**.

45° WEDGE TOPS

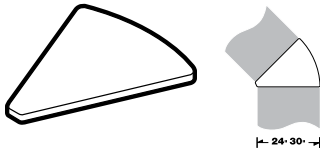

45° Wedge Top

CNW2424	24 x 24 x 1.12	92.5	10	1	\$203
CNW3030	30 x 30 x 1.12	100	14	1.56	\$249

T-mold edging. Predrilled with threaded steel inserts for **linking installations ONLY**.

THREE WAY CONNECTOR TOPS

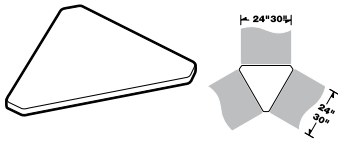

Three Way Connector Top

CNY2424	24 x 24 x 1.12	85	13	1	\$190
CNY3030	30 x 30 x 1.12	92.5	18	1.56	\$231

T-mold edging. Predrilled with threaded steel inserts for **linking installations ONLY**.

HALF ROUND TOPS

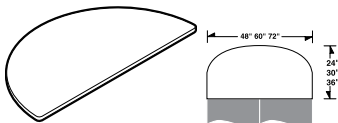

Half Round Top

CNHFS2448	24 x 48 x 1.12	70	36	2	\$292
CNHFS3060	30 x 60 x 1.12	70	56	3.13	\$379
CNHFS3672	36 x 72 x 1.12	65	81	3.30	\$650

T-mold edging. Predrilled with threaded steel inserts for freestanding and linking installations.

- *Requires three legs for freestanding*

EXTENDED HALF ROUND TOPS

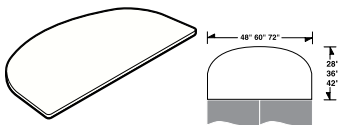

Extended Half Round Top

CNHE24	28 x 48 x 1.13	65	50	1.88	\$357
CNHE30	36 x 60 x 1.13	65	75	2.87	\$499
CNHE36	42 x 72 x 1.13	65	102	3.88	\$793

T-mold edging. Predrilled with threaded steel inserts for **linking installations ONLY**.

Required Specifications

Top Finish
Edge Finish

Optional Specifications

Grommet

Accessories

Power Block

MODESTY PANELS

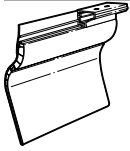

Modesty Panel



Modesty Panel

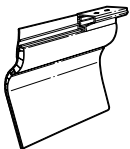

Modesty Panel

MODEL#	DIMENSIONS D x W x H	FREIGHT CLASS	WT./LBS.	CUBIC FT.	LIST PRICE
CNCA2430	2.75 x 35 x 11.75	150	2.80	.50	\$168
CNCA3036	2.75 x 43 x 11.75	150	3.30	.60	\$198
CNCA3642	2.75 x 53 x 11.75	150	3.90	.70	\$259

For use with **CNC crescent tops**. 11 3/4" high, Black plastic, attractive ribbed design. Includes two fold-away installation clips and flexible privacy strips. Connects to predrilled holes in table top.

- *Can not be used when worksurface tops are attached to flip top legs.*

CNQA2424	2.75 x 27 x 11.75	150	2.20	.40	\$144
CNQA3030	2.75 x 35 x 11.75	150	2.80	.50	\$168
CNQA3636	2.75 x 44 x 11.75	150	3.30	.60	\$198

For use with **CNQ quarter round tops**. 11 3/4" high, Black plastic, attractive ribbed design. Includes two fold-away installation clips and flexible privacy strips. Connects to predrilled holes in table top.

- *Can not be used when worksurface tops are attached to flip top legs.*

CNRA2030	2.75 x 29 x 11.75	150	2.80	.50	\$144
CNRA2036	2.75 x 35 x 11.75	150	3.30	.60	\$168
CNRA2042	2.75 x 41 x 11.75	150	3.90	.70	\$198
CNRA2048	2.75 x 47 x 11.75	150	4.40	.80	\$224
CNRA2054	2.75 x 53 x 11.75	150	5	.90	\$259
CNRA2060	2.75 x 59 x 11.75	150	5.50	1	\$281
CNRA2066	2.75 x 65 x 11.75	150	6.10	1.10	\$308
CNRA2072	2.75 x 71 x 11.75	150	6.60	1.20	\$336

CNRA2430	2.75 x 29 x 11.75	150	2.80	.50	\$144
CNRA2436	2.75 x 35 x 11.75	150	3.30	.60	\$168
CNRA2442	2.75 x 41 x 11.75	150	3.90	.70	\$198
CNRA2448	2.75 x 47 x 11.75	150	4.40	.80	\$224
CNRA2454	2.75 x 53 x 11.75	150	5	.90	\$259
CNRA2460	2.75 x 59 x 11.75	150	5.50	1	\$281
CNRA2466	2.75 x 65 x 11.75	150	6.10	1.10	\$308
CNRA2472	2.75 x 71 x 11.75	150	6.60	1.20	\$336

CNRA3036	2.75 x 35 x 11.75	150	3.30	.60	\$168
CNRA3042	2.75 x 41 x 11.75	150	3.90	.70	\$198
CNRA3048	2.75 x 47 x 11.75	150	4.40	.80	\$224
CNRA3054	2.75 x 53 x 11.75	150	5	.90	\$259
CNRA3060	2.75 x 59 x 11.75	150	5.50	1	\$281
CNRA3066	2.75 x 65 x 11.75	150	6.10	1.10	\$308
CNRA3072	2.75 x 71 x 11.75	150	6.60	1.20	\$336

CNRA3642	2.75 x 41 x 11.75	150	3.90	.70	\$198
CNRA3648	2.75 x 47 x 11.75	150	4.40	.80	\$224
CNRA3654	2.75 x 53 x 11.75	150	5	.90	\$259
CNRA3660	2.75 x 59 x 11.75	150	5.50	1	\$281
CNRA3666	2.75 x 65 x 11.75	150	6.10	1.10	\$308
CNRA3672	2.75 x 71 x 11.75	150	6.60	1.20	\$336

For use with **CNR/CNRU rectangular tops**. 11 3/4" high, Black plastic, attractive ribbed design. Includes two fold-away installation clips and flexible privacy strips. Connects to predrilled holes in table top.

- *Can not be used when worksurface tops are attached to flip top legs.*

Required Specifications

Top Finish
Edge Finish

Optional Specifications

Grommet

Accessories

Power Block

MODESTY PANELS

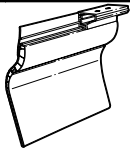

Modesty Panel

MODEL# DIMENSIONS FREIGHT CLASS WT/LBS. CUBIC FT. LIST PRICE

D x W x H

CNSA2424	2.75 x 23 x 11.75	150	2.20	.40	\$115
CNSA3030	2.75 x 29 x 11.75	150	2.80	.50	\$144
CNSA3636	2.75 x 35 x 11.75	150	3.30	.60	\$168

For use with **long side of CNS square tops**. 11 3/4" high, Black plastic, attractive ribbed design. Includes two fold-away installation clips and flexible privacy strips. Connects to predrilled holes in table top.

- *Can not be used when worksurface tops are attached to flip top legs.*

CNTA2048L	2.75 x 43 x 11.75	150	4.40	.80	\$198
CNTA2060L	2.75 x 55 x 11.75	150	5.50	1.20	\$259

CNTA2448L	2.75 x 43 x 11.75	150	4.40	.80	\$198
CNTA2460L	2.75 x 55 x 11.75	150	5.50	1.20	\$259

CNTA3060L	2.75 x 55 x 11.75	150	5.50	1.20	\$259
CNTA3072L	2.75 x 67 x 11.75	150	6.60	1.40	\$308

CNTA3660L	2.75 x 55 x 11.75	150	5.50	1.20	\$259
CNTA3672L	2.75 x 67 x 11.75	150	6.60	1.40	\$308

For use with **long side of CNT trapezoid tops**. 11 3/4" high, Black plastic, attractive ribbed design. Includes two fold-away installation clips and flexible privacy strips. Connects to predrilled holes in table top.

- *Can not be used when worksurface tops are attached to flip top legs.*

CNTA2048S	2.75 x 24 x 11.75	150	2.20	.40	\$115
CNTA2060S	2.75 x 36 x 11.75	150	2.80	.50	\$168

CNTA2448S	2.75 x 23 x 11.75	150	2.20	.40	\$115
CNTA2460S	2.75 x 35 x 11.75	150	2.20	.40	\$168

CNTA3060S	2.75 x 29 x 11.75	150	2.80	.50	\$144
CNTA3072S	2.75 x 41 x 11.75	150	2.80	.50	\$198

CNTA3660S	2.75 x 23 x 11.75	150	3.30	.60	\$115
CNTA3672S	2.75 x 35 x 11.75	150	3.30	.60	\$168

For use with **short side of CNT trapezoid tops**. 11 3/4" high, Black plastic, attractive ribbed design. Includes two fold-away installation clips and flexible privacy strips. Connects to predrilled holes in table top.

- *Can not be used when worksurface tops are attached to flip top legs.*

CNWA2424	2.75 x 17 x 11.75	150	2.20	.40	\$88
CNWA3030	2.75 x 22 x 11.75	150	2.80	.50	\$115

For use with **CNW wedge tops**. 11 3/4" high, Black plastic, attractive ribbed design. Includes two fold-away installation clips and flexible privacy strips. Connects to predrilled holes in table top.

- *Can not be used when worksurface tops are attached to flip top legs.*

CNYA2424	2.75 x 22 x 11.75	150	2.20	.40	\$107
CNYA3030	2.75 x 27 x 11.75	150	2.80	.50	\$132

For use with **CNY triangle tops**. 11 3/4" high, Black plastic, attractive ribbed design. Includes two fold-away installation clips and flexible privacy strips. Connects to predrilled holes in table top.

- *Can not be used when worksurface tops are attached to flip top legs.*

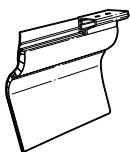

Modesty Panel

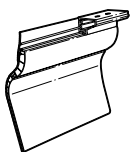

Modesty Panel

Required Specifications

Top Finish
Edge Finish

Optional Specifications

Grommet

Accessories

Power Block

WIRE MANAGEMENT UNITS

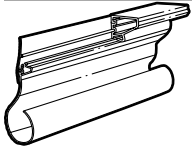

Wire Management Unit

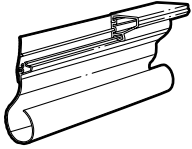

Wire Management Unit

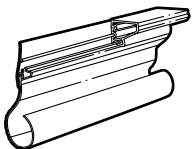

Wire Management Unit

MODEL#	DIMENSIONS D x W x H	FREIGHT CLASS	WT./LBS.	CUBIC FT.	LIST PRICE
CNCB2430	2.75 x 35 x 6	70	1.50	.50	\$126
CNCB3036	2.75 x 43 x 6	70	1.80	.60	\$142
CNCB3642	2.75 x 53 x 6	250	2.10	.70	\$185

For use with **CNC crescent tops**. 6" high, Black plastic, attractive ribbed design. Includes two fold-away installation clips and flexible privacy strips. Connects to predrilled holes in table top. Can be used with or without wire management grommet.

- *Can not be used when worksurface tops are attached to flip top legs.*

CNQB2424	2.75 x 27 x 6	70	1.20	.40	\$106
CNQB3030	2.75 x 35 x 6	70	1.50	.50	\$126
CNQB3636	2.75 x 44 x 6	70	1.80	.60	\$165

For use with **CNQ quarter round tops**. 6" high, Black plastic, attractive ribbed design. Includes two fold-away installation clips and flexible privacy strips. Connects to predrilled holes in table top. Can be used with or without wire management grommet.

- *Can not be used when worksurface tops are attached to flip top legs.*

CNRB2030	2.75 x 29 x 6	70	1.50	.50	\$106
CNRB2036	2.75 x 35 x 6	70	1.80	.60	\$126
CNRB2042	2.75 x 41 x 6	250	2.10	.70	\$142
CNRB2048	2.75 x 47 x 6	250	2.40	.80	\$198
CNRB2054	2.75 x 53 x 6	250	2.70	.90	\$206
CNRB2060	2.75 x 59 x 6	250	3	1	\$206
CNRB2066	2.75 x 65 x 6	250	3.30	1.10	\$206
CNRB2072	2.75 x 71 x 6	250	3.60	1.20	\$281
CNRB2430	2.75 x 29 x 6	70	1.50	.50	\$106
CNRB2436	2.75 x 35 x 6	70	1.80	.60	\$126
CNRB2442	2.75 x 41 x 6	250	2.10	.70	\$142
CNRB2448	2.75 x 47 x 6	250	2.40	.80	\$198
CNRB2454	2.75 x 53 x 6	250	2.70	.90	\$206
CNRB2460	2.75 x 59 x 6	250	3	1	\$206
CNRB2466	2.75 x 65 x 6	250	3.30	1.10	\$206
CNRB2472	2.75 x 71 x 6	250	3.60	1.20	\$281
CNRB3036	2.75 x 35 x 6	70	1.80	.60	\$126
CNRB3042	2.75 x 41 x 6	250	2.10	.70	\$142
CNRB3048	2.75 x 47 x 6	250	2.40	.80	\$165
CNRB3054	2.75 x 53 x 6	250	2.70	.90	\$185
CNRB3060	2.75 x 59 x 6	250	3	1	\$206
CNRB3066	2.75 x 65 x 6	250	3.30	1.10	\$245
CNRB3072	2.75 x 71 x 6	250	3.60	1.20	\$281
CNRB3642	2.75 x 41 x 6	250	2.10	.70	\$142
CNRB3648	2.75 x 47 x 6	250	2.40	.80	\$185
CNRB3654	2.75 x 53 x 6	250	2.70	.90	\$185
CNRB3660	2.75 x 59 x 6	250	3	1	\$206
CNRB3666	2.75 x 65 x 6	250	3.30	1.10	\$206
CNRB3672	2.75 x 71 x 6	250	3.60	1.20	\$281

For use with **CNR/CNRU rectangular tops**. 6" high, Black plastic, attractive ribbed design. Includes two fold-away installation clips and flexible privacy strips. Connects to predrilled holes in table top. Can be used with or without wire management grommet.

- *Can not be used when worksurface tops are attached to flip top legs.*

Required Specifications

Top Finish
Edge Finish

Optional Specifications

Grommet

Accessories

Power Block

WIRE MANAGEMENT UNITS

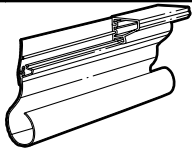

Wire Management Unit

MODEL# DIMENSIONS FREIGHT CLASS WT./LBS. CUBIC FT. LIST PRICE

D x W x H

CNSB2424	2.75 x 23 x 6	70	1.80	.40	\$84
CNSB3030	2.75 x 29 x 6	70	1.50	.50	\$106
CNSB3636	2.75 x 35 x 6	70	1.80	.60	\$126

For use with **CNS square tops**. 6" high, Black plastic, attractive ribbed design. Includes two fold-away installation clips and flexible privacy strips. Connects to predrilled holes in table top. Can be used with or without wire management grommet.

- *Can not be used when worksurface tops are attached to flip top legs.*

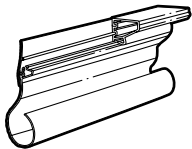

Wire Management Unit

CNTB2048L	2.75 x 43 x 6	250	2.40	.80	\$142
CNTB2060L	2.75 x 55 x 6	250	3	1	\$185
CNTB2448L	2.75 x 43 x 6	250	2.40	.80	\$142
CNTB2460L	2.75 x 55 x 6	250	3	1	\$185
CNTB3060L	2.75 x 55 x 6	250	3	1	\$185
CNTB3072L	2.75 x 67 x 6	250	3.60	1.20	\$259
CNTB3660L	2.75 x 55 x 6	250	3	1	\$185
CNTB3672L	2.75 x 67 x 6	250	3.60	1.20	\$259

For use with **long side of CNT trapezoid tops**. 6" high, Black plastic, attractive ribbed design. Includes two fold-away installation clips and flexible privacy strips. Connects to predrilled holes in table top. Can be used with or without wire management grommet.

- *Can not be used when worksurface tops are attached to flip top legs.*

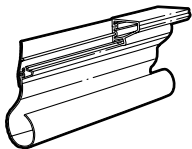

Wire Management Unit

CNTB2048S	2.75 x 23 x 6	70	1.20	.40	\$84
CNTB2060S	2.75 x 35 x 6	70	1.50	.50	\$126
CNTB2448S	2.75 x 23 x 6	70	1.20	.40	\$84
CNTB2460S	2.75 x 35 x 6	70	1.20	.40	\$126
CNTB3060S	2.75 x 29 x 6	70	1.50	.50	\$106
CNTB3072S	2.75 x 41 x 6	70	1.50	.50	\$142
CNTB3660S	2.75 x 23 x 6	70	1.80	.60	\$84
CNTB3672S	2.75 x 35 x 6	70	1.80	.60	\$126

For use with **short side of CNT trapezoid tops**. 6" high, Black plastic, attractive ribbed design. Includes two fold-away installation clips and flexible privacy strips. Connects to predrilled holes in table top. Can be used with or without wire management grommet.

- *Can not be used when worksurface tops are attached to flip top legs.*

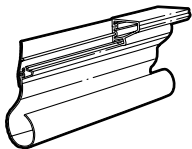

Wire Management Unit

CNWB2424	2.75 x 17 x 6	70	1.20	.40	\$68
CNWB3030	2.75 x 22 x 6	70	1.50	.50	\$84

For use with **CNW wedge tops**. 6" high, Black plastic, attractive ribbed design. Includes two fold-away installation clips and flexible privacy strips. Connects to predrilled holes in table top. Can be used with or without wire management grommet.

- *Can not be used when worksurface tops are attached to flip top legs.*

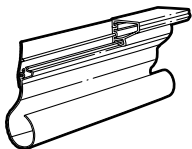

Wire Management Unit

CNYB2424	2.75 x 22 x 6	70	1.20	.40	\$84
CNYB3030	2.75 x 27 x 6	70	1.50	.50	\$106

For use with **CNY triangle tops**. 6" high, Black plastic, attractive ribbed design. Includes two fold-away installation clips and flexible privacy strips. Connects to predrilled holes in table top. Can be used with or without wire management grommet.

- *Can not be used when worksurface tops are attached to flip top legs.*

Required Specifications

Top Finish
Edge Finish

Optional Specifications

Grommet

Accessories

Power Block

MODESTY PANEL WITH WIRE MANAGEMENT

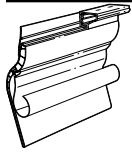

Modesty Panel with Wire Management

MODEL#	DIMENSIONS D x W x H	FREIGHT CLASS	WT./LBS.	CUBIC FT.	LIST PRICE
CNCC2430	2.75 x 35 x 11.75	100	4.30	.50	\$185
CNCC3036	2.75 x 43 x 11.75	100	5.10	.60	\$211
CNCC3642	2.75 x 53 x 11.75	100	6	.70	\$273

For use with **CNC crescent tops**. 11 3/4" high, Black plastic, attractive ribbed design. Includes two fold-away installation clips and flexible privacy strips. Connects to predrilled holes in table top. Can be used with or without wire management grommet.

- *Can not be used when worksurface tops are attached to flip top legs.*

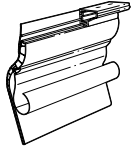

Modesty Panel with Wire Management

CNQC2424	2.75 x 27 x 11.75	100	3.40	.40	\$153
CNQC3030	2.75 x 35 x 11.75	100	4.30	.50	\$185
CNQC3636	2.75 x 44 x 11.75	100	5.10	.60	\$211

For use with **CNC quarter round tops**. 11 3/4" high, Black plastic, attractive ribbed design. Includes two fold-away installation clips and flexible privacy strips. Connects to predrilled holes in table top. Can be used with or without wire management grommet.

- *Can not be used when worksurface tops are attached to flip top legs.*

CNRC2030	2.75 x 29 x 11.75	100	4.30	.50	\$153
CNRC2036	2.75 x 35 x 11.75	100	5.10	.60	\$185
CNRC2042	2.75 x 41 x 11.75	100	6	.70	\$211
CNRC2048	2.75 x 47 x 11.75	100	6.80	.80	\$246
CNRC2054	2.75 x 53 x 11.75	100	7.70	.90	\$273
CNRC2060	2.75 x 59 x 11.75	100	8.50	1	\$304
CNRC2066	2.75 x 65 x 11.75	100	9.40	1.10	\$329
CNRC2072	2.75 x 71 x 11.75	100	10.20	1.20	\$348

CNRC2430	2.75 x 29 x 11.75	100	4.30	.50	\$153
CNRC2436	2.75 x 35 x 11.75	100	5.10	.60	\$185
CNRC2442	2.75 x 41 x 11.75	100	6	.70	\$211
CNRC2448	2.75 x 47 x 11.75	100	6.80	.80	\$246
CNRC2454	2.75 x 53 x 11.75	100	7.70	.90	\$273
CNRC2460	2.75 x 59 x 11.75	100	8.50	1	\$304
CNRC2466	2.75 x 65 x 11.75	100	9.40	1.10	\$329
CNRC2472	2.75 x 71 x 11.75	100	10.20	1.20	\$348

CNRC3036	2.75 x 35 x 11.75	100	5.10	.60	\$185
CNRC3042	2.75 x 41 x 11.75	100	6	.70	\$211
CNRC3048	2.75 x 47 x 11.75	100	6.80	.80	\$246
CNRC3054	2.75 x 53 x 11.75	100	7.70	.90	\$273
CNRC3060	2.75 x 59 x 11.75	100	8.50	1	\$304
CNRC3066	2.75 x 65 x 11.75	100	9.40	1.10	\$329
CNRC3072	2.75 x 71 x 11.75	100	10.20	1.20	\$348

CNRC3642	2.75 x 41 x 11.75	100	6	.70	\$211
CNRC3648	2.75 x 47 x 11.75	100	6.80	.80	\$246
CNRC3654	2.75 x 53 x 11.75	100	7.70	.90	\$273
CNRC3660	2.75 x 59 x 11.75	100	8.50	1	\$304
CNRC3666	2.75 x 65 x 11.75	100	9.40	1.10	\$329
CNRC3672	2.75 x 71 x 11.75	100	10.20	1.20	\$348

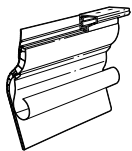

Modesty Panel with Wire Management

For use with **CNR/CNRU rectangular tops**. 11 3/4" high, Black plastic, attractive ribbed design. Includes two fold-away installation clips and flexible privacy strips. Connects to predrilled holes in table top. Can be used with or without wire management grommet.

- *Can not be used when worksurface tops are attached to flip top legs.*

Required Specifications

Top Finish
Leg Finish
Edge Finish

Optional Specifications

Grommet

Accessories

Power Block

MODESTY PANEL WITH WIRE MANAGEMENT

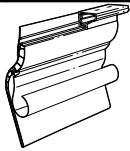

Modesty Panel with Wire Management

MODEL# DIMENSIONS FREIGHT CLASS WT./LBS. CUBIC FT. LIST PRICE

D x W x H

CNSC2424	2.75 x 23 x 11.75	100	3.50	.40	\$126
CNSC3030	2.75 x 29 x 11.75	100	4.30	.50	\$153
CNSC3636	2.75 x 35 x 11.75	100	5.10	.60	\$185

For use with **CNC square tops**. 11 3/4" high, Black plastic, attractive ribbed design. Includes two fold-away installation clips and flexible privacy strips. Connects to predrilled holes in table top. Can be used with or without wire management grommet.

- *Can not be used when worksurface tops are attached to flip top legs.*

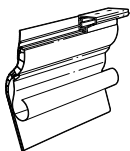

Modesty Panel with Wire Management

CNTC2048L	2.75 x 43 x 11.75	100	6.80	.80	\$211
CNTC2060L	2.75 x 55 x 11.75	100	8.50	1	\$273
CNTC2448L	2.75 x 43 x 11.75	100	6.80	.80	\$211
CNTC2460L	2.75 x 55 x 11.75	100	8.50	1	\$273
CNTC3060L	2.75 x 55 x 11.75	100	8.50	1	\$273
CNTC3072L	2.75 x 67 x 11.75	100	10.20	1.20	\$329
CNTC3660L	2.75 x 55 x 11.75	100	8.50	1	\$273
CNTC3672L	2.75 x 67 x 11.75	100	10.20	1.20	\$329

For use with **long side of CNT trapezoid tops**. 11 3/4" high, Black plastic, attractive ribbed design. Includes two fold-away installation clips and flexible privacy strips. Connects to predrilled holes in table top. Can be used with or without wire management grommet.

- *Can not be used when worksurface tops are attached to flip top legs.*

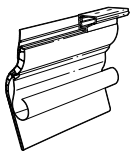

Modesty Panel with Wire Management

CNTC2048S	2.75 x 24 x 11.75	100	3.40	.40	\$126
CNTC2060S	2.75 x 36 x 11.75	100	3.50	.50	\$185
CNTC2448S	2.75 x 23 x 11.75	100	3.40	.40	\$126
CNTC2460S	2.75 x 35 x 11.75	100	3.40	.40	\$185
CNTC3060S	2.75 x 29 x 11.75	100	4.30	.50	\$153
CNTC3072S	2.75 x 41 x 11.75	100	4.30	.50	\$211
CNTC3660S	2.75 x 23 x 11.75	100	5.10	.60	\$126
CNTC3672S	2.75 x 35 x 11.75	100	5.10	.60	\$185

For use with **short side of CNT trapezoid tops**. 11 3/4" high, Black plastic, attractive ribbed design. Includes two fold-away installation clips and flexible privacy strips. Connects to predrilled holes in table top. Can be used with or without wire management grommet.

- *Can not be used when worksurface tops are attached to flip top legs.*

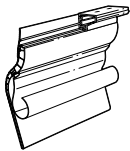

Modesty Panel with Wire Management

CNWC2424	2.75 x 17 x 11.75	100	3.40	.40	\$103
CNWC3030	2.75 x 22 x 11.75	100	4.30	.50	\$126

For use with **CNW wedge tops**. 11 3/4" high, Black plastic, attractive ribbed design. Includes two fold-away installation clips and flexible privacy strips. Connects to predrilled holes in table top. Can be used with or without wire management grommet.

- *Can not be used when worksurface tops are attached to flip top legs.*

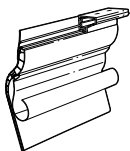

Modesty Panel with Wire Management

CNYC2424	2.75 x 22 x 11.75	100	3.40	.40	\$126
CNYC3030	2.75 x 27 x 11.75	100	4.30	.50	\$153

For use with **CNY triangle tops**. 11 3/4" high, Black plastic, attractive ribbed design. Includes two fold-away installation clips and flexible privacy strips. Connects to predrilled holes in table top. Can be used with or without wire management grommet.

- *Can not be used when worksurface tops are attached to flip top legs.*

Required Specifications

Top Finish
Leg Finish
Edge Finish

Optional Specifications

Grommet

Accessories

Power Block

T LEGS

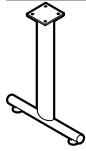

"T" Leg

MODEL#	DIMENSIONS D x W x H	FREIGHT CLASS	WT./LBS.	CUBIC FT.	LIST PRICE
GCNTLEG18	5.25 x 18 x 27.63	125	15	2.10	\$195
GCNTLG18P	5.25 x 18 x 27.63	125	17	2.10	\$385

18" long with plastic elliptical column cover, leveling glides and end caps. **For assembly with 20" tops.**

- For a single leg, order **GCNTLEG18**.
- For a pair of legs (set of 2), order **GCNTLG18P**.
- Chrome (CH) is available (on foot only). **ADD \$70.00** list for model GCNTLEG18 and **\$140.00** list for model GCNTLG18P.

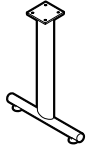

"T" Leg

GCNTLEG24	5.25 x 20 x 27.63	150	9	2.10	\$195
GCNTLG24P	5.25 x 20 x 27.63	100	17	2.10	\$385

20" long with plastic elliptical column cover, leveling glides and end caps. **For assembly with 24" tops.**

- For a single leg, order **GCNTLEG24**.
- For a pair of legs (set of 2), order **GCNTLG24P**.
- Chrome (CH) is available (on foot only). **ADD \$70.00** list for model GCNTLEG24 and **\$140.00** list for model GCNTLG24P.

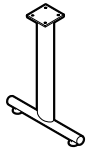

"T" Leg

GCNTLEG30	5.25 x 26 x 27.63	250	10	2.60	\$211
GCNTLG30P	5.25 x 26 x 27.63	125	19	2.60	\$420

26" long with plastic elliptical column cover, leveling glides and end caps. **For assembly with 30" tops.**

- For a single leg, order **GCNTLEG30**.
- For a pair of legs (set of 2), order **GCNTLG30P**.
- Chrome (CH) is available (on foot only). **ADD \$70.00** list for model GCNTLEG30 and **\$140.00** list for model GCNTLG30P.

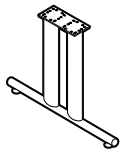

"T" Leg

GCNTLEG36	5.75 x 32 x 27.63	150	14	3.30	\$425
GCNTLG36P	5.25 x 32 x 27.63	100	27	3.30	\$845

32" long with double post plastic elliptical column cover, leveling glides and end caps. **For assembly with 36" tops.**

- For a single leg, order **GCNTLEG36**.
- For a pair of legs (set of 2), order **GCNTLG36P**.
- Chrome (CH) is available (on foot only). **ADD \$70.00** list for model GCNTLEG36 and **\$140.00** list for model GCNTLG36P.

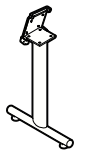

Flip Top "T" Leg

CNTFLEG18	5.25 x 18 x 27.63	150	10	2.40	\$366
-----------	-------------------	-----	----	------	--------------

18" long with plastic elliptical column cover, leveling glides and end caps. **For assembly with 20" deep rectangular and square tops only.** Hinged plate with locking mechanism to lock in open or closed position. Cannot be installed with thumbscrews.

- *Can not be used when modesty panels and wire management are attached to worksurface tops.*
- List Price is per **each leg**.
- Chrome (CH) is available (on foot only). **ADD \$70.00** list

Required Specifications
Leg Finish

T LEGS

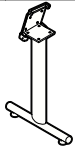

Flip Top "T" Leg

MODEL#	DIMENSIONS	FREIGHT CLASS	WT/LBS.	CUBIC FT.	LIST PRICE
	D x W x H				
CNTFLEG24	6.5 x 20 x 27.62	150	10	2.40	\$366

20" long with plastic elliptical column cover, leveling glides and end caps. **For assembly with 24" deep rectangular and square tops only.** Hinged plate with locking mechanism to lock in open or closed position. Cannot be installed with thumbscrews.

- *Can not be used when modesty panels and wire management are attached to worksurface tops.*
- *List Price is per **each leg**.*
- Chrome (CH) is available (on foot only). **ADD \$70.00** list



Flip Top "T" Leg

CNTFLEG30	6.5 x 26 x 27.62	150	14	3	\$385
-----------	------------------	-----	----	---	--------------

26" long with plastic elliptical column cover, leveling glides and end caps. **For assembly with 30" deep rectangular and square tops only.** Hinged plate with locking mechanism to lock in open or closed position. Cannot be installed with thumbscrews.

- *Can not be used when modesty panels and wire management are attached to worksurface tops.*
- *List Price is per **each leg**.*
- Chrome (CH) is available (on foot only). **ADD \$70.00** list

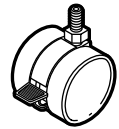

Braking Caster

CNCB	0 x 0 x 1.5	70	1	.15	\$41
------	-------------	----	---	-----	-------------

1 1/2" dual wheel manual locking caster. **Set of 2.** Suggested for hard floor surfaces and industrial carpeting. Casters are fully interchangeable with glides. Black only.

- *For use with ConnecTABLES units only.*
- *Casters DO NOT affect table height.*

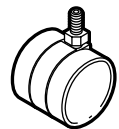

Caster

CNC1	0 x 0 x 1.5	70	1	.15	\$34
------	-------------	----	---	-----	-------------

1 1/2" dual wheel caster. **Set of 2.** Non-Locking. Suggested for hard floor surfaces and industrial carpeting. Casters are fully interchangeable with glides. Black only.

- *For use with ConnecTABLES units only.*
- *Casters DO NOT affect table height.*



Thumbscrews

CNTS	1.25 x 1.25 x 1.5	70	1	.15	\$25
------	-------------------	----	---	-----	-------------

Triangular thumbscrew with 3/4" steel thread. Set of 4. Can be used in place of factory supplied screws to allow installation of "T" legs to tops without tools. Black only.

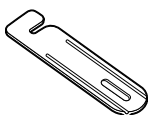

Ganging Connector

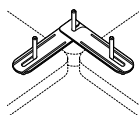

CNGFP	5 x 2.5 x 1.13	70	.20	.10	\$44
-------	----------------	----	-----	-----	-------------

Black epoxy coated 13 gauge steel with 2 thumbscrews included. Used to connect tabletops together for additional stability or for connecting freestanding tops together. Holes with steel inserts are located in the corner of all tops to accommodate this plate. **Sold individually.**

Required Specifications

Leg Finish



Designed by Zoey Chu, **Junction™** provides an affordable solution for your table applications. Choose from a variety of table top designs: Rectangular, Half Round, Trapezoid and Keystone to create a unique table for your boardroom, classroom or presentation room application.

A freestanding or shared leg configuration with the unique “Y” leg allows you to either create a permanent table or one that can be reconfigured quickly and easily. A Straight leg is available for use with half round and Keystone tops.

Shared leg configurations allow more legroom and can also decrease cost because they use fewer components. Freestanding configurations provide more flexibility for changing environments.



Features and Benefits

- Tops are 1” thick and constructed of 45 lb. density particleboard.
- Optional Radius Corners (RM) available at no upcharge.
- Optional modesty panel with integrated wire trough available.
- Casters available with or without manual locks provide mobility.
- Black grommets for convenient wire management can be ordered factory installed.
- Optional, easy-to-use thumbscrews allow installation without tools.
- JUNCTION™ tops are available in Global laminate finishes with 2 leg options.



Y Leg Design



Modesty Panel



Shared leg configuration provides more legroom and decreases the overall costs

GENERAL INFORMATION

- Junction is a series of multi-purpose tables for classroom, training room and boardroom applications
- Ability for tables to be set up as freestanding or shared leg configuration
- Unique design by Zooley Chu
- Half round, trapezoid and Keystone tops are available to create a variety of package configurations
- Rectangular tops are available in 20", 24" and 30" depths
- Optional modesty panels with integrated wire troughs are available
- Optional large electrical manager provides a safe environment for equipment wires
- Special width tops are available. Use next size up.
- Shipped R.T.A. (Ready to Assemble). Each component is packaged individually; Legs are shipped one per carton.
- Global laminate and seating products are in compliance with stringent emission guidelines set out by the Greenguard Environmental Institute under the standards for low emitting products and materials. www.greenguard.org
- **Level 2 Certified**

WORKSURFACES

- Tops are 1" thick, made of 45 lb. density particle board covered on both sides with high performance thermally fused laminate.
- Laminate finishes are available in High Pressure. Contact your Customer Service Representative for a quote.
- If other than a Global standard laminate finish is preferred, contact your Customer Service Representative. Information needed includes the name of the laminate manufacturer, color name, number and model of table. You will then be given a quote for this special order.

CONSTRUCTION

- Rectangular tops 54" in length and longer include a steel support channel for structural rigidity
- Tops are pre-drilled with threaded steel inserts
- Special width tops are available. Use next size up.
- Tables adjust from 28 ¾" to 29 ¾" high.

EDGE DETAIL

- Tops are sealed with Global's preferred edge in matching color.
- Optional Radius Corners (**RM**) are available on rectangular tops at no upcharge.

LEGS

- Unique Y design
- Straight leg available for assembly with Half Round tops and Keystone tops
- Heavy duty steel construction
- Coated with environmentally friendly recycled paint that provides a durable finish
- Black plastic leveling glides offer 1" adjustability
- Available in **Black (BK)** or **Tungsten 2 (TU2)** finish
- Y Legs: 17½" leg span - 20"d Top, 21½" leg span - 24"d Top, 24½" leg span - 30"d Top.

CASTERS

- Optional casters are available
- 1½" Dual wheel casters with or without manual lock. Full 360° swivel
- Can be used in any combination with or without standard glides
- Suggested for carpeted surfaces
- Available in black only
- Sold in packages of two

GANGING

- Ganging plates are available for ganging workstations together
- Ganging plates are black epoxy coated steel plates with two thumbscrews
- Provides maximum stability and torque reduction

FLUSH PLATE

- Suggested for top clusters (fixed configurations for additional stability)
- Sold individually and shipped with two thumbscrews for mounting
- No tools required
- Flush plate allows for ganging together of two or more tops

WIRE MANAGEMENT

- Available for managing additional larger wires and power connectors
- 3½" high x 4¼" deep Black PVC channel attaches to the underside of top

1. SPECIFY MODEL NUMBER

2. SPECIFY FINISH

Laminate Finishes:

ACJ	Absolute Acajou	ASN	Asian Night
AWC	Avant Cherry	AWH	Avant Honey
BLK	Black	BRC	Brushed Cobalt
CSJ	Constellation Java	DES	Dark Espresso
GRY	Grey	HGT	Hayden Grey
QTM	Quartered Mahogany	SKC	Shaker Cherry
SOG	Storm Grey	TFW	Tiger Fruitwood
TMA	Tiger Mahogany	TMP	Tiger Maple
TWL	Tiger Walnut	WHT	White
WHC	White Chocolate*	WGY	Willow Grey
WCR	Winter Cherry		

*textured

Legs:

TU2	Tungsten 2
BLK	Black

3. SPECIFY OPTIONS

Modesty Panels

- 11¼" high panel attaches to the underside of worksurface top
- Standard with integrated wire trough
- Available in black PVC

Grommets

- Grommets are available in **Rectangular and Trapezoid** Tops (left, center or right). See below for available locations. Order as: **AG1, AG2 or AG3.....Add \$65** For **Keystone** worksurface locations, order as **AG2. ADD 65.00**
- Grommet hole dimensions are 3 ¼" wide x 1 7/8" deep.

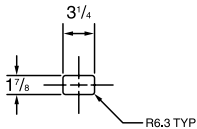

- Grommets may be placed at non-standard locations. Order as: **AGS - ADD \$65.00** A drawing must be supplied with vertical and horizontal dimensions to the center of the cut-out (as in drawing above). Please refer to CUSTOM GROMMET LOCATION FORM in the back reference section.

Power Block

- A Power Block (model **PMSPDM**) may be ordered on all worksurfaces.
- A Power Block is a rectangular worksurface power/data module with one electrical duplex receptacle and two data (RJ45) receptacles. 9' black cord included. Power Block dimensions are 3 ½" deep x 6 ½" wide x 2 ¾" high.
- To purchase a Power Block, you must specify both the Power Block cut-out location and the Power Block model #. Order Power Block as **PMSPDM, ADD \$238**. Power Blocks are available in standard worksurface locations (left, center or right). Order as **E1, E2 or E3. ADD \$65.00**.



Power Block **PMSPDM, Add \$238**

EXAMPLES OF GROMMET AND POWER BLOCK POSITIONS

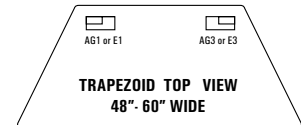
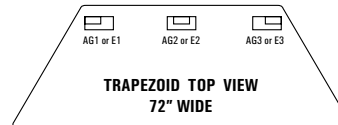
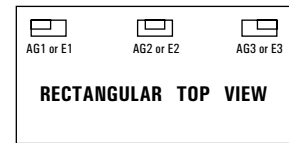
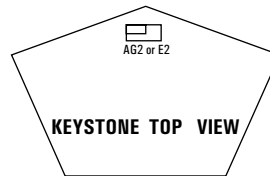

VILLA CUTOUTS

- Optional Villa cutout available in standard worksurface locations (left, center or right) **for Rectangular Tables**. Order as: **V1, V2 or V3.....Add \$65 for each cutout**.
- Villa cutouts may be placed at non-standard locations. Please contact customer service.
- **Villa is only available on Bungee, Junction and Connectables series**

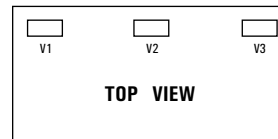

RECTANGULAR TOPS

MODEL# DIMENSIONS FREIGHT CLASS WT/LBS. CUBIC FT. LIST PRICE

D x W x H

JNR2042	20 x 42 x 1	65	26	1.10	\$247
JNR2048	20 x 48 x 1	65	29	1.15	\$276
JNRU2054	20 x 54 x 1	65	33	1.30	\$343
JNRU2060	20 x 60 x 1	65	37	1.40	\$368
JNRU2066	20 x 66 x 1	65	41	1.55	\$398
JNRU2072	20 x 72 x 1	65	45	1.66	\$424
JNR2442	24 x 42 x 1	65	31	1.25	\$247
JNR2448	24 x 48 x 1	65	35	1.40	\$276
JNRU2454	24 x 54 x 1	65	42	1.52	\$343
JNRU2460	24 x 60 x 1	65	47	1.67	\$368
JNRU2466	24 x 66 x 1	65	52	1.82	\$398
JNRU2472	24 x 72 x 1	65	57	2	\$424
JNR3042	30 x 42 x 1	65	38	1.51	\$300
JNR3048	30 x 48 x 1	65	44	1.70	\$316
JNRU3054	30 x 54 x 1	65	52	1.90	\$394
JNRU3060	30 x 60 x 1	65	59	2.10	\$422
JNRU3066	30 x 66 x 1	65	64	2.26	\$451
JNRU3072	30 x 72 x 1	65	70	2.50	\$482

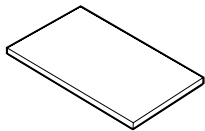

Rectangular Top

Pre-drilled with threaded steel inserts for freestanding and linking installations. **Tops 54" and longer are standard with a 16 gauge steel support channel.**

HALF ROUND TOPS

JNHFS2040	20 x 40 x 1	70	23	1.05	\$261
JNHFS2048	20 x 48 x 1	65	27.50	1.15	\$270
JNHFS2448	24 x 48 x 1	65	34	1.40	\$291
JNHFS2454	27 x 54 x 1	65	38.25	1.52	\$345
JNHFS3060	30 x 60 x 1	60	53	1.67	\$378
JNHFS3066	33 x 66 x 1	60	58.30	1.82	\$472

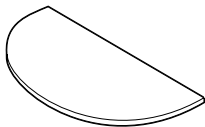

Half Round Top

Pre-drilled with threaded steel inserts for freestanding and linking installations. Four legs are required for freestanding configurations.

- **JNHFS2040/JNHFS2048** for use with 20" deep joining edge
- **JNHFS2448/JNHFS2454** for use with 24" deep joining edge
- **JNHFS3060/JNHFS3066** for use with 30" deep joining edge

TRAPEZOID TOPS

JNTT2048	15.25 x 48 x 1	65	27.50	1.15	\$254
JNTT2060	15.25 x 60 x 1	65	34	1.40	\$304
JNTT2448	20.5 x 48 x 1	65	33	1.40	\$288
JNTT2460	20.5 x 60 x 1	65	41.25	1.67	\$348
JNTT3060	25.75 x 60 x 1	65	50.50	2.10	\$380
JNTT3072	25.75 x 72 x 1	65	61	2.50	\$424

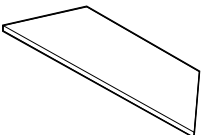

Trapezoid Top

Pre-drilled with threaded steel inserts for linking installations. **Not freestanding.**

- **JNTT2040/JNTT2048** for use with 20" deep joining edge
- **JNTT2448/JNTT2454** for use with 24" deep joining edge
- **JNTT3060/JNTT3066** for use with 30" deep joining edge

Required Specifications
Finish

Optional Specifications
Grommet

Accessories
Power Block

KEYSTONE

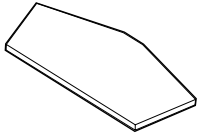

Keystone Top

MODEL#	DIMENSIONS D x W x H	FREIGHT CLASS	WT/LBS.	CUBIC FT.	LIST PRICE
JN5S2424	24 x 42 x 1	65	35	1.40	\$295
JN5S3030	30 x 54 x 1	65	53	2.10	\$378

Pre-drilled with threaded steel inserts for linking installations. **Not freestanding**

- **JN5S2424** for use with 20" deep joining edge
- **JN5S3030** for use with 24" deep joining edge

MODESTY PANELS

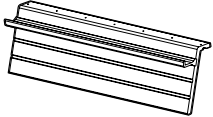

Modesty Panel

JNMP42	6.92 x 29.19 x 11.25	250	3.70	1.50	\$203
JNMP48	6.92 x 35.19 x 11.25	250	4.50	1.75	\$229
JNMP54	6.92 x 41.19 x 11.25	250	5	2	\$255
JNMP60	6.92 x 47.19 x 11.25	250	5.90	2.25	\$282
JNMP66	6.92 x 53.19 x 11.25	250	6.60	2.50	\$301
JNMP72	6.92 x 59.19 x 11.25	250	7.40	2.75	\$328

For use with **JNR rectangular tops**. 11 ¼" high, Black plastic, attractive ribbed design. Includes integrated wire trough. Connects to predrilled holes in table top.

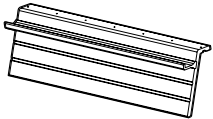

Modesty Panel

JNMTT2048	6.92 x 22.75 x 11.25	250	2.80	1.17	\$180
JNMTT2060	6.92 x 34.75 x 11.25	250	4.30	1.70	\$202
JNMTT2448	6.92 x 19 x 11.25	250	2.50	1	\$180
JNMTT2460	6.92 x 31 x 11.25	250	3.90	1.55	\$202
JNMTT3060	6.92 x 26 x 11.25	250	3.30	1.30	\$180
JNMTT3072	6.92 x 38 x 11.35	250	4.70	1.90	\$202

For use with **JNTT trapezoid tops**. 11 ¼" high, Black plastic, attractive ribbed design. Includes integrated wire trough. Connects to predrilled holes in table top.

WIRE MANAGEMENT



Wire Manager

JNEC5S	4.14 x 12.5 x 3.63	70	1	.10	\$52
--------	--------------------	----	---	-----	-------------

For use with **JN5S Keystone Tops**. For managing additional wires and power connectors. 3½"H Black PVC channel connects to predrilled holes in table top.



Wire Manager

JNEC42	4.14 x 41.75 x 3.63	125	2.52	.33	\$128
JNEC48	4.14 x 47.75 x 3.63	125	2.88	.38	\$150
JNEC54	4.14 x 53.75 x 3.63	125	3.24	.43	\$169
JNEC60	4.14 x 59.75 x 3.63	125	3.60	.48	\$188
JNEC66	4.14 x 65.75 x 3.63	125	3.96	.53	\$197
JNEC72	4.14 x 71.75 x 3.63	125	4.32	.58	\$255

For use with **JNR Rectangular Tops**. For managing additional wires and power connectors. 3½"H Black PVC channel connects to predrilled holes in the table top.

Required Specifications
Finish

Optional Specifications
Grommet (Keystone)

Accessories
Power Block (Keystone)

WIRE MANAGER



Wire Manager

MODEL# DIMENSIONS FREIGHT CLASS WT/LBS. CUBIC FT. LIST PRICE

D x W x H

JNECT2048	4.14 x 28.75 x 3.63	70	1.74	.23	\$128
JNECT2060	4.14 x 40.75 x 3.63	125	2.46	.33	\$180
JNECT2448	4.14 x 24.75 x 3.63	70	1.50	.20	\$128
JNECT2460	4.14 x 36.75 x 3.63	125	2.22	.30	\$180
JNECT3060	4.14 x 31.75 x 3.63	70	1.92	.25	\$128
JNECT3072	4.14 x 43.75 x 3.63	125	2.64	.35	\$180

For use with **JNTT Trapezoid Tops**. For managing additional wires and power connectors. 3½" high Black PVC channel connects to predrilled holes in the table top.

LEGS

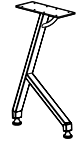

"Y" Leg

GJNLEG20	17.25 x 2 x 27.5	150	8.50	2	\$195
----------	------------------	-----	------	---	--------------

Leg span is 17½". Leveling glides are standard. **For assembly with 20" deep tops**

- List Price is per each leg.
- Available in Black (BK) or Tungsten 2 (TU2)

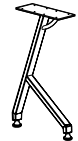

"Y" Leg

GJNLEG24	21.5 x 2 x 27.5	150	10	2.50	\$195
----------	-----------------	-----	----	------	--------------

Leg span is 21½". Leveling glides are standard. **For assembly with 24" deep tops**

- List Price is per each leg.
- Available in Black (BK) or Tungsten 2 (TU2)

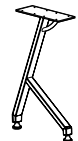

"Y" Leg

GJNLEG30	24.5 x 2 x 27.5	250	11	2.85	\$211
----------	-----------------	-----	----	------	--------------

Leg span is 24½". Leveling glides are standard. **For assembly with 30" deep tops**

- List Price is per each leg.
- Available in Black (BK) or Tungsten 2 (TU2)

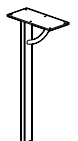

Straight Leg

JNLEG	1 x 2 x 27.5	150	6	1.30	\$172
-------	--------------	-----	---	------	--------------

Leveling glides are standard. **For assembly with half round and keystone tops**. Mounting plate is 11" deep by 5" wide.

- List Price is per each leg.
- Available in Black (BK) or Tungsten 2 (TU2)

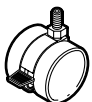

Braking Caster

JNCB	--	--	--	--	\$39
------	----	----	----	----	-------------

1½" dual wheel manual locking caster. Set of 2. Suggested for carpeted surfaces. Casters are fully interchangeable with glides. Black only.

- For use with Junction units only
- Casters DO NOT affect table height

Required Specifications

Finish

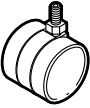
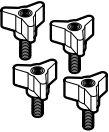
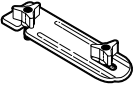
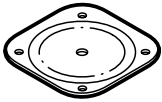
LEGS	MODEL#	DIMENSIONS	FREIGHT CLASS	WT./LBS.	CUBIC FT.	LIST PRICE
		D x W x H				
 <p>Caster</p>	JNC1	--	--	--	--	\$32
	<p>1½" dual wheel caster. Non-Locking. Set of 2. Suggested for carpeted surfaces. Casters are fully interchangeable with glides. Black only.</p> <ul style="list-style-type: none"> • For use with Junction units only • Casters DO NOT affect table height 					
 <p>Thumbscrews</p>	JNTS	--	--	--	--	\$22
	<p>Triangular thumbscrew with ¾" steel thread. Set of 4. Can be used in place of factory supplied screws to allow installation of "Y" legs to tops without tools. Black only.</p>					
 <p>Ganging Flush Plate</p>	JNGFP	--	--	--	--	\$42
	<p>Black epoxy coated steel plates with 2 thumbscrews included. Used to connect table tops together for additional stability or for connecting freestanding tops together. Holes with steel inserts are located in the corner of the tops to accommodate this plate. Sold individually.</p>					
 <p>Flush Plate</p>	JNFP1	5.25 d x 5.25 w	--	--	--	\$22
	JNFP4	5.25 d x 5.25 w	--	--	--	\$87
	<p>Assures alignment on adjoining worksurfaces of the same height. Bolts included. Available in Black only.</p> <p>JNFP1 - 1 per carton.</p> <p>JNFP4 - 4 per carton.</p>					

NUTCRACKER



This innovative boardroom table opens from a traditional meeting shape to a V-shaped configuration for training and presentation functions. Electrical and data outlets can be specified in the worksurfaces to support computers and projectors. In the closed position, the mobile side table provides extra seating.

Large or Small Meetings

Side table inserts to provide additional space for large meeting groups. Remove the side table and close the table for smaller meetings.

Teleconferencing and Training

Open "V" configuration permits each participant to be viewed by the camera during a teleconference. For training uses, the open "V" provides a clear view for both the trainee and instructor.

Technological Support

A worksurface electrical/telecommunications hub provides optional power and network capability.



Features and Benefits

- Arrange in an "open V" to use the side table as a serving cart.
- Power Blocks provide one electrical duplex and two data receptacles (RJ45) at the worksurface
- Grommet permits access through worksurface to wire management channels and into drum base
- Electrical/Communication Hub provides two electrical and two data (RJ45) receptacles at the worksurface.
- Hub Grommet permits access from worksurface through drum to floor electrical and data receptacles



Electrical/Communication Hub

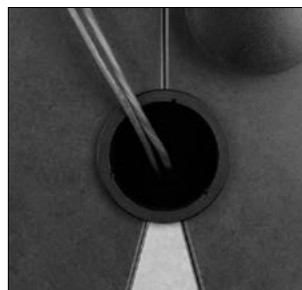

Hub Grommet

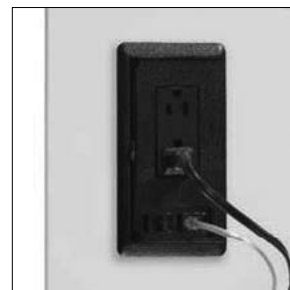

Optional Power Module

GENERAL INFORMATION

- Nutcracker Boardroom Tables are versatile and exciting tables that may be arranged in a variety of ways.
- Choose a “traditional” boardroom scenario when arranging as closed. The trapezoid table is perfect for use as a serving cart.
- Arrange in an “open V” to use the side table as a serving cart.
- Arrange in a closed fan shape for presentations/training to allow for maximum viewing during a teleconference. A “closed V” also allows for extra seating.
- Global laminate and seating products are in compliance with stringent emission guidelines set out by the Greenguard Environmental Institute under the standards for low emitting products and materials. www.greenguard.org
- **Level 2 Certified**



1. Closed with side table



2. Open V-Shape with side table



3. Closed Fan Shape with side table

1. Choose a “traditional” boardroom scenario when arranging as closed. The trapezoid table is perfect for use as a serving cart.
2. Arrange in an “open V” to use the side table as a serving cart.
3. Arrange in a closed fan shape for presentations/training to allow for maximum viewing during a teleconference. A “closed V” also allows for extra seating, with side table.

- Additional legs are required in all table arrangements for extra support (correct quantity of legs are included in the layouts listed on the following pages). For quick and easy removal of legs, it is recommended to order a set of thumbscrews.

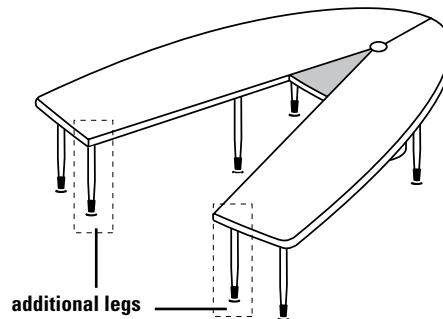

1. SPECIFY MODEL NUMBER

2. SPECIFY FINISH

Laminate Finishes - Main Tops (LWING_L & LWING_R), Accessory Tops (LTRAP_, LPIE_):

Laminate Finishes:

ACJ	Absolute Acajou	ASN	Asian Night
AWC	Avant Cherry	AWH	Avant Honey
BLK	Black	BRC	Brushed Cobalt
CSJ	Constellation Java	DES	Dark Espresso
HGT	Hayden Grey	QTM	Quartered Mahogany
SKC	Shaker Cherry	SOG	Storm Grey
TFW	Tiger Fruitwood	TMA	Tiger Mahogany
TMP	Tiger Maple	TWL	Tiger Walnut
WHT	White	WHC	White Chocolate
WGY	Willow Grey	WCR	Winter Cherry

Drum Base (LDRUM):

SOG	Storm Grey
BLK	Black

Donut (LDONUT):

BLK	Black
-----	-------

Edging:

BK	Black
TS	Storm Grey

Legs:

SOG	Storm Grey
BLK	Black
TUN	Tungsten (available with 10% upcharge)

COMPONENTS OF THE 8 FOOT NUTCRACKER BOARDROOM TABLE

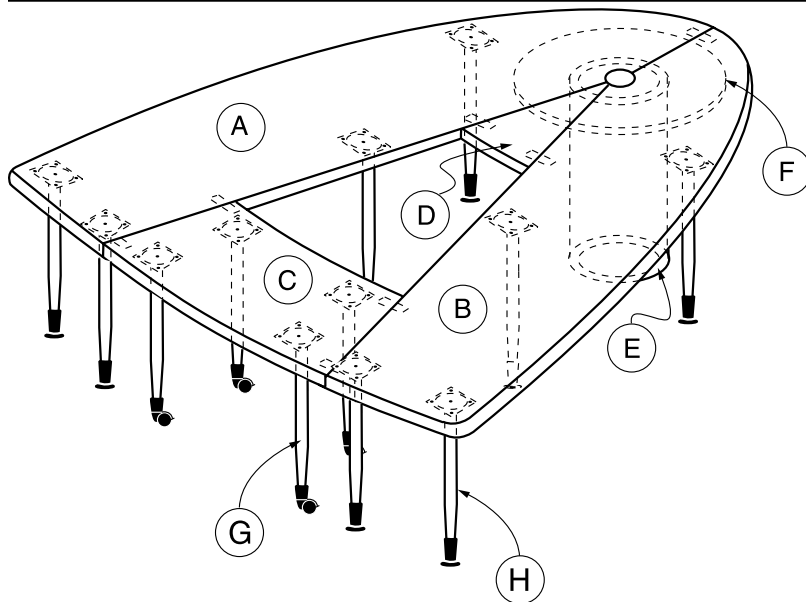

Main Tops:
A - LWING8L - Main Top - Left - 8 ft.
B - LWING8R - Main Top - Right - 8 ft.

Accessory Tops:
C - LTRAP8 - Trapezoid Table Top - 8 ft.
D - LPIE810 - Pie Top - 8 ft/10 ft

Drum Base:
E - LDRUM - Drum Base w/Hardware

Donut:
F - LDONUT - Donut

Legs:
G - LCL294 - Leg with Lockable Caster (qty of 4)
H - LLL291 - Leg with Leveller (qty of 8)

N NUTCRACKER - LAYOUTS

8' Nutcracker Table

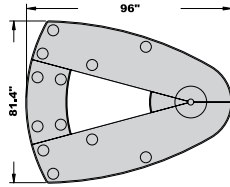
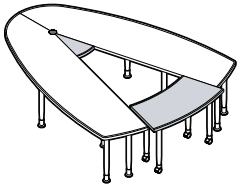

Qty	Description	Model Number	Dimensions	Freight Class	Wt./lbs.	Cubic Ft.	List Price
1	Main Top - Right	LWING8-R	28 x 96 x 1.13	85	82.70	6.30	\$589
1	Main Top - Left	LWING8-L	28 x 96 x 1.13	85	82.70	6.30	\$589
1	Trapezoid Top	LTRAP8	25.5 x 37.2 x 1.13	70	29	1.80	\$304
1	Pie Top	LPIE810	12 x 22.5 x 1.13	92.5	9	.90	\$96
1	Drum Base (hardware included)	LDRUM	18.75 x 18.75 x 27.25	150	31.40	6.10	\$846
1	Donut Spacer (between drum base and top. Black only)	LDONUT	40 x 40 x .69	100	30.50	3.80	\$262
8	Leg w/leveler. Sold singly.	LLL291	5.25 x 5.25 x 28	100	4.80	.52	\$112 x 8
1	Leg w/lockable caster. Sold in quantity of 4.	LCL294	5.25 x 5.25 x 28	100	18.40	2.10	\$435

SAMPLE LAYOUT TOTAL

\$4017

8' Nutcracker Table w/Grommets & Electrical/Communication Hub

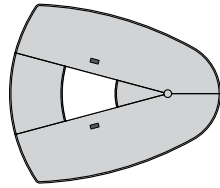
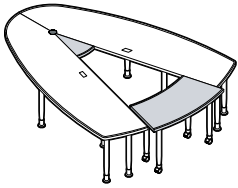

Qty	Description	Model Number	Dimensions	Freight Class	Wt./lbs.	Cubic Ft.	List Price
1	Main Top w/Grommet - Right	LWING8-RG	28 x 96 x 1.13	85	82.70	6.30	\$627
1	Main Top w/Grommet- Left	LWING8-LG	28 x 96 x 1.13	85	82.70	6.30	\$627
1	Trapezoid Top	LTRAP8	25.5 x 37.2 x 1.13	70	29	1.80	\$304
1	Pie Top	LPIE810	12 x 22.5 x 1.13	92.5	9	.90	\$96
1	Drum Base (hardware included)	LDRUM	18.75 x 18.75 x 27.25	150	31.40	6.10	\$846
1	Donut Spacer (between drum base and top. Black only)	LDONUT	40 x 40 x .69	100	30.50	3.80	\$262
8	Leg w/leveler. Sold singly.	LLL291	5.25 x 5.25 x 28	100	4.80	.52	\$112 x 8
1	Leg w/lockable caster. Sold in quantity of 4.	LCL294	5.25 x 5.25 x 28	100	18.40	2.10	\$435
1	Electrical/Communication Hub	PLECHUB	4.25 x 4.25 x 4.75	100	2	.25	\$579

SAMPLE LAYOUT TOTAL

\$4672

8' Nutcracker Table w/Power Blocks & Electrical/Communication Hub

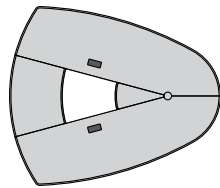
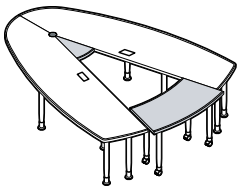

Qty	Description	Model Number	Dimensions	Freight Class	Wt./lbs.	Cubic Ft.	List Price
1	Main Top for Power Block - Right	LWING8-RE	28 x 96 x 1.13	85	82.70	6.30	\$627
1	Main Top for Power Block - Left	LWING8-LE	28 x 96 x 1.13	85	82.70	6.30	\$627
1	Trapezoid Top	LTRAP8	25.5 x 37.2 x 1.13	70	29	1.80	\$304
1	Pie Top	LPIE810	12 x 22.5 x 1.13	92.5	9	.90	\$96
1	Drum Base (hardware included)	LDRUM	18.75 x 18.75 x 27.25	150	31.40	6.10	\$846
1	Donut Spacer (between drum base and top. Black only)	LDONUT	40 x 40 x .69	100	30.50	3.80	\$262
8	Leg w/leveler. Sold singly.	LLL291	5.25 x 5.25 x 28	100	4.80	.52	\$112 x 8
1	Leg w/lockable caster. Sold in quantity of 4.	LCL294	5.25 x 5.25 x 28	100	18.40	2.10	\$435
1	Electrical/Communication Hub	PLECHUB	4.25 x 4.25 x 4.75	100	2	.25	\$579
2	Worksurface Power Block	PMSPDM	3.5 x 6.5 x 2.75	70	2	.10	\$238 x 2

SAMPLE LAYOUT TOTAL

\$5148

10' Nutcracker Table

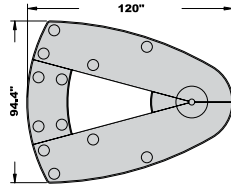
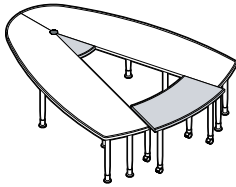

Qty	Description	Model Number	Dimensions	Freight Class	Wt./lbs.	Cubic Ft.	List Price
1	Main Top - Right	LWING10-R	30 x 120 x 1.13	85	111.10	8.30	\$687
1	Main Top - Left	LWING10-L	30 x 120 x 1.13	85	111.10	8.30	\$687
1	Trapezoid Top	LTRAP10	25.5 x 37.2 x 1.13	70	39	2.20	\$362
1	Pie Top	LPIE810	12 x 22.5 x 1.13	92.5	9	.90	\$96
1	Drum Base (hardware included)	LDRUM	18.75 x 18.75 x 27.25	150	31.40	6.10	\$846
1	Donut Spacer (between drum base and top. Black only)	LDONUT	40 x 40 x .69	100	30.50	3.80	\$262
8	Leg w/leveler. Sold singly.	LLL291	5.25 x 5.25 x 28	100	4.80	.52	\$112 x 8
1	Leg w/lockable caster. Sold in quantity of 4.	LCL294	5.25 x 5.25 x 28	100	18.40	2.10	\$435

SAMPLE LAYOUT TOTAL

\$4271

10' Nutcracker Table w/Grommets & Electrical/Communication Hub

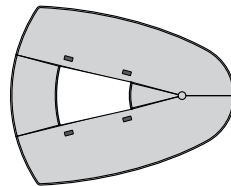
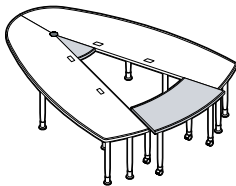

Qty	Description	Model Number	Dimensions	Freight Class	Wt./lbs.	Cubic Ft.	List Price
1	Main Top w/Grommet - Right	LWING10-RG	30 x 120 x 1.13	85	111.10	8.30	\$730
1	Main Top w/Grommet - Left	LWING10-LG	30 x 120 x 1.13	85	111.10	8.30	\$730
1	Trapezoid Top	LTRAP10	25.5 x 37.2 x 1.13	70	39	2.20	\$362
1	Pie Top	LPIE810	12 x 22.5 x 1.13	92.5	9	.90	\$96
1	Drum Base (hardware included)	LDRUM	18.75 x 18.75 x 27.25	150	31.40	6.10	\$846
1	Donut Spacer (between drum base and top. Black only)	LDONUT	40 x 40 x .69	100	30.50	3.80	\$262
8	Leg w/leveler. Sold singly.	LLL291	5.25 x 5.25 x 28	100	4.80	.52	\$112 x 8
1	Leg w/lockable caster. Sold in quantity of 4.	LCL294	5.25 x 5.25 x 28	100	18.40	2.10	\$435
1	Electrical/Communication Hub	PLECHUB	4.25 x 4.25 x 4.75	100	2	.25	\$579

SAMPLE LAYOUT TOTAL

\$4936

10' Nutcracker Table w/Power Blocks & Electrical/Communication Hub

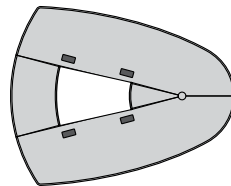
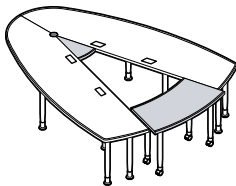

Qty	Description	Model Number	Dimensions	Freight Class	Wt./lbs.	Cubic Ft.	List Price
1	Main Top for Power Block - Right	LWING10-RE	30 x 120 x 1.13	85	111.10	8.30	\$730
1	Main Top for Power Block - Left	LWING10-LE	30 x 120 x 1.13	85	111.10	8.30	\$730
1	Trapezoid Top	LTRAP10	25.5 x 37.2 x 1.13	70	39	2.20	\$362
1	Pie Top	LPIE810	12 x 22.5 x 1.13	92.5	9	.90	\$96
1	Drum Base (hardware included)	LDRUM	18.75 x 18.75 x 27.25	150	31.40	6.10	\$846
1	Donut Spacer (between drum base and top. Black only)	LDONUT	40 x 40 x .69	100	30.50	3.80	\$262
8	Leg w/leveler. Sold singly.	LLL291	5.25 x 5.25 x 28	100	4.80	.52	\$112 x 8
1	Leg w/lockable caster. Sold in quantity of 4.	LCL294	5.25 x 5.25 x 28	100	18.40	2.10	\$435
1	Electrical/Communication Hub	PLECHUB	4.25 x 4.25 x 4.75	100	2	.25	\$579
4	Worksurface Power Block	PMSPDM	3.5 x 6.5 x 2.75	70	2	.10	\$238 x 4

SAMPLE LAYOUT TOTAL

\$5888

N NUTCRACKER - LAYOUTS

12' Nutcracker Table

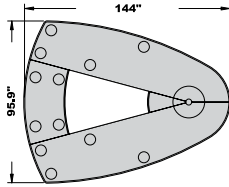
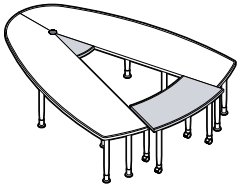

Qty	Description	Model Number	Dimensions	Freight Class	Wt./lbs.	Cubic Ft.	List Price
1	Main Top - Right	LWING12-R	28 x 144 x 1.13	85	135.90	9.90	\$787
1	Main Top - Left	LWING12-L	28 x 144 x 1.13	85	135.90	9.90	\$787
1	Trapezoid Top	LTRAP12	26 x 49.9 x 1.13	70	40	2.20	\$381
1	Pie Top	LPIE12	9.75 x 22.5 x 1.13	100	8	.90	\$96
1	Drum Base (hardware included)	LDRUM	18.75 x 18.75 x 27.25	150	31.40	6.10	\$846
1	Donut Spacer (between drum base and top. Black only)	LDONUT	40 x 40 x .69	100	30.50	3.80	\$262
8	Leg w/leveler. Sold singly.	LLL291	5.25 x 5.25 x 28	100	4.80	.52	\$112 x 8
1	Leg w/lockable caster. Sold in quantity of 4.	LCL294	5.25 x 5.25 x 28	100	18.40	2.10	\$435
SAMPLE LAYOUT TOTAL							\$4490

12' Nutcracker Table w/Grommets & Electrical/Communication Hub

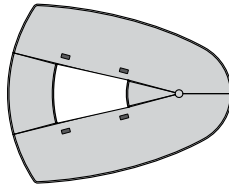
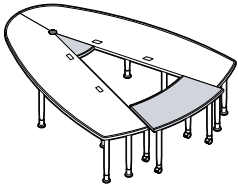

Qty	Description	Model Number	Dimensions	Freight Class	Wt./lbs.	Cubic Ft.	List Price
1	Main Top w/Grommet - Right	LWING12-RG	28 x 144 x 1.13	85	135.90	9.90	\$828
1	Main Top w/Grommet - Left	LWING12-LG	28 x 144 x 1.13	85	135.90	9.90	\$828
1	Trapezoid Top	LTRAP12	26 x 49.9 x 1.13	70	40	2.20	\$381
1	Pie Top	LPIE12	9.75 x 22.5 x 1.13	100	8	.90	\$96
1	Drum Base (hardware included)	LDRUM	18.75 x 18.75 x 27.25	150	31.40	6.10	\$846
1	Donut Spacer (between drum base and top. Black only)	LDONUT	40 x 40 x .69	100	30.50	3.80	\$262
8	Leg w/leveler. Sold singly.	LLL291	5.25 x 5.25 x 28	100	4.80	.52	\$112 x 8
1	Leg w/lockable caster. Sold in quantity of 4.	LCL294	5.25 x 5.25 x 28	100	18.40	2.10	\$435
1	Electrical/Communication Hub	PLECHUB	4.25 x 4.25 x 4.75	100	2	.25	\$579
SAMPLE LAYOUT TOTAL							\$5151

12' Nutcracker Table w/Power Blocks & Electrical/Communication Hub

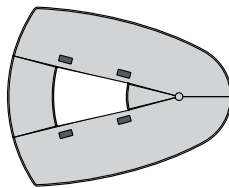
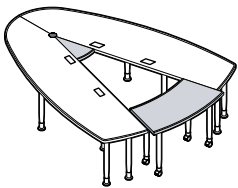

Qty	Description	Model Number	Dimensions	Freight Class	Wt./lbs.	Cubic Ft.	List Price
1	Main Top for Power Block - Right	LWING12-RE	28 x 144 x 1.13	85	135.90	9.90	\$828
1	Main Top for Power Block - Left	LWING12-LE	28 x 144 x 1.13	85	135.90	9.90	\$828
1	Trapezoid Top	LTRAP12	26 x 49.9 x 1.13	70	40	2.20	\$381
1	Pie Top	LPIE12	9.75 x 22.5 x 1.13	100	8	.90	\$96
1	Drum Base (hardware included)	LDRUM	18.75 x 18.75 x 27.25	150	31.40	6.10	\$846
1	Donut Spacer (between drum base and top. Black only)	LDONUT	40 x 40 x .69	100	30.50	3.80	\$262
8	Leg w/leveler. Sold singly.	LLL291	5.25 x 5.25 x 28	100	4.80	.52	\$112 x 8
1	Leg w/lockable caster. Sold in quantity of 4.	LCL294	5.25 x 5.25 x 28	100	18.40	2.10	\$435
1	Electrical/Communication Hub	PLECHUB	4.25 x 4.25 x 4.75	100	2	.25	\$579
4	Worksurface Power Block	PMSPDM	3.5 x 6.5 x 2.75	70	2	.10	\$238 x 4
SAMPLE LAYOUT TOTAL							\$6103

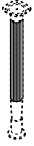
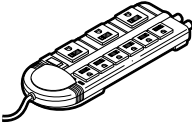
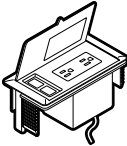
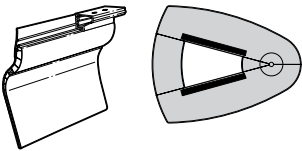
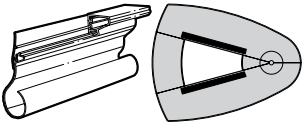
ACCESSORIES	MODEL#	DIMENSIONS	FREIGHT CLASS	WT/LBS.	CUBIC FT.	LIST PRICE
 <p>Electrical/Communication Hub</p>		D x W x H				
	PLECHUB	4.25 x 4.25 x 4.75	100	2	.25	\$579
<p>Circular power/data unit composed of two electrical receptacles and two category 5E data modules (hardwire to module required). Available in Black only. Ships UPS.</p> <ul style="list-style-type: none"> • <i>Unit is the same for all size tables.</i> 						
 <p>Leg Mounted Wire Manager</p>	LLWM	1.5 x 1.8 x 16	70	.50	.08	\$33
	<p>Black PVC wire management channel with 1 3/8" x 3/4" capacity used to carry wiring up and down the leg to a wall or floor outlet for a clean organized appearance. Ships UPS.</p>					
 <p>Power Bar</p>	POWER BAR	6 x 13 x 2.5	70	1.70	.12	\$237
	<p>9 grounded electrical outlets with surge protection. One phone/fax/modem outlet with EMI/EFI noise reduction filter. Three conductor 10 foot cord. Ships UPS.</p> <ul style="list-style-type: none"> • 15 amp fused circuit breaker protects DBS (Direct Broadcast Satellite Systems). Electrical rating is 125V / 15A / 1875W. 					
 <p>Power Block</p>	PMSPDM	3.5 x 6.5 x 2.75	70	2	.10	\$238
	<p>Rectangular worksurface power/data module. One electrical duplex receptacle and two data (RJ45) receptacles. 9' Black cord.</p>					
 <p>Modesty Panel Package</p>	LA829	2.75 x 29 x 11.75	150	5.60	1	\$254
	LA1053	2.75 x 53 x 11.75	150	10	1.80	\$460
	LA1277	2.75 x 77 x 11.75	150	14.20	2.60	\$603
	<p>11 3/4" high Black PVC modesty panel with attractive ribbed design. Includes fold-away installation clips and flexible privacy strips. Connects to predrilled holes in table bottom. Each package includes two panels.</p> <ul style="list-style-type: none"> • Order LA829 for 8 foot table. • Order LA1053 for 10 foot table. • Order LA1277 for 12 foot table. 					
 <p>Wire Management Channel Package</p>	LB829	2.75 x 29 x 6	150	4.20	1	\$188
	LB1053	2.75 x 53 x 6	250	6.40	1.80	\$396
	LB1277	2.75 x 77 x 6	250	9	2.60	\$501
	<p>6" high Black PVC wire management channel with attractive ribbed design. Includes fold-away installation clips and flexible privacy strips. Connects to predrilled holes in table bottom. Can be used with or without wire management grommet. Each package includes two channels.</p> <ul style="list-style-type: none"> • Order LB829 for 8 foot table. • Order LB1053 for 10 foot table. • Order LB1277 for 12 foot table. 					

N NUTCRACKER

ACCESSORIES

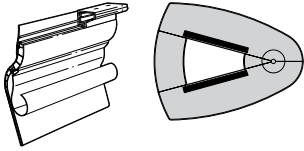

Modesty Panel with Wire Management Package

MODEL#	DIMENSIONS D x W x H	FREIGHT CLASS	WT/LBS.	CUBIC FT.	LIST PRICE
LC829	2.75 x 29 x 11.75	100	8.60	1	\$271
LC1053	2.75 x 53 x 11.75	100	15.40	1.80	\$485
LC1277	2.75 x 77 x 11.75	100	22	2.60	\$681

11¾" high Black PVC modesty panel with wire management channel. Attractive ribbed design. Includes fold-away installation clips and flexible privacy strips. Connects to predrilled holes in table bottom. Can be used with or without wire management grommet. **Each package includes two panels.**

- Order **LC829** for 8 foot table.
- Order **LC1053** for 10 foot table.
- Order **LC1277** for 12 foot table.

WORKSURFACE SUPPORTS



Leg with Leveller

LLL291	5.25 x 5.25 x 28	100	4.80	.52	\$112
LLL294	5.25 x 5.25 x 28	100	18.40	2.10	\$435

Tapered steel leg (2" diameter) with a custom designed leveller that adjusts up to 1½". Legs available in Black or Storm Grey. Leveller available in Black only. Bolts included. Ships UPS.

- *Leg available in Tungsten finish with Tungsten leveller - 10% upcharge.*
- **LLL291** is shipped 1 per carton.
- **LLL294** is shipped 4 per carton.

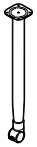

Leg with Lockable Caster

LCL291	5.25 x 5.25 x 28	100	4.80	.52	\$112
LCL294	5.25 x 5.25 x 28	100	18.40	2.10	\$435

Tapered steel leg (2" diameter) with a custom designed lockable caster. Legs available in Black or Storm Grey. Leveller available in Black only. Bolts included. Ships UPS.

- *Leg available in Tungsten finish with Tungsten caster - 10% upcharge.*
- **LCL291** is shipped 1 per carton.
- **LCL294** is shipped 4 per carton.

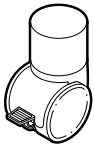

Caster

LRC1	--	--	--	--	\$22
------	----	----	----	----	-------------

Replacement lockable caster. Can retrofit onto a leg with leveller #LLL291. Available in Black only. Ships UPS.

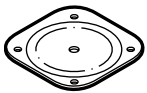

Ganging Flush Plate

LFF1	--	--	--	--	\$25
LFF4	--	--	--	--	\$92

Plate to link two, three or four worksurfaces simultaneously. Available in Black only. Bolts included. Ships UPS.

- **LFF1** is shipped 1 per carton.
- **LFF4** is shipped 4 per carton.

SWAP TABLES

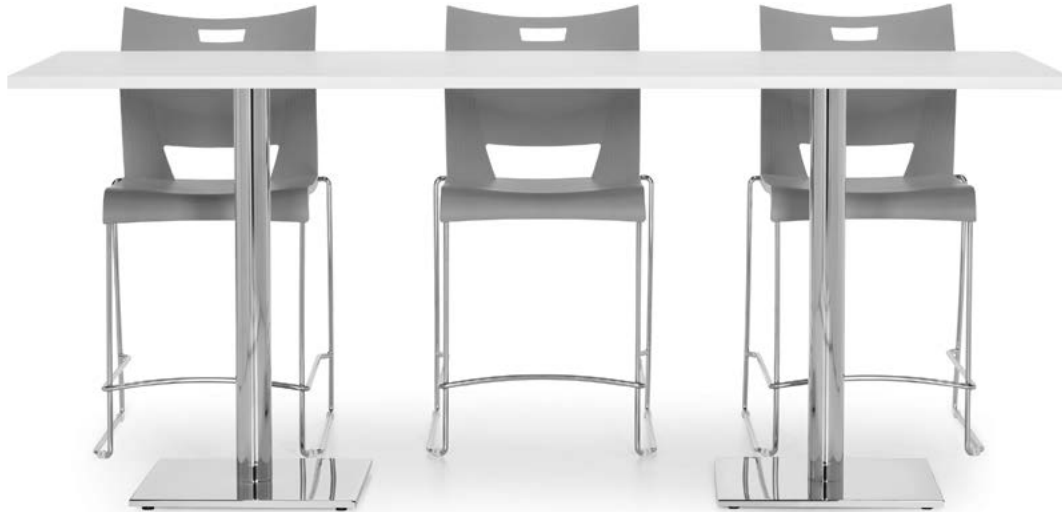

Global's casual meeting and café tables are suitable for a variety of applications: break rooms, dedicated/ enclosed meeting rooms, casual/open area meeting spaces (seated, counter & bar height options), private office (accommodate smaller 3-4 person discussions). Tops and bases are sold separately for ease of specification. Mix and Match capabilities to create spaces for multi-purpose use. Choose your top, choose your base. Create the combination you desire for the way you want to work.



Features and Benefits

- All worksurfaces are 1" thick, constructed of 45 lb. density particle board covered on both sides with high performance, thermally fused laminate.
- Worksurfaces feature Global's preferred edge on all sides
- Bases are constructed of a ½" thick solid steel metal plate with cover - round or square.
- Wire grommets and power block cutouts are available on most tables
- 3 heights: seated height at 29"H overall, counter height at 36"H and bar height at 41.5"H



Base detail



Glide

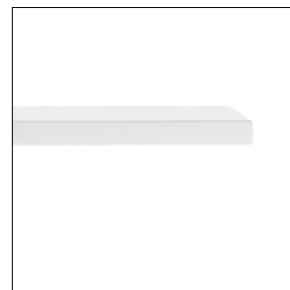

Top / Edge detail

GENERAL INFORMATION

- SWAP is a series of tables for use primarily in casual meeting spaces and café areas.
- A new way of specifying the exact worksurface requirements for today's shared spaces or to meet the needs of growing companies. What you choose today can be moved around or added to as the company changes and grows.
- Finish palette coordinates with most Global laminate casegoods series – tables can stand alone or blend with other solutions.
- Each component is packed individually. Bases are shipped assembled, one per carton. Easy to assemble.
- Global's counter and bar height stools are a perfect compliment to swap tables with counter and bar height bases.
- Global laminate and seating products are in compliance with stringent emission guidelines set out by the Greenguard Environmental Institute under the standards for low emitting products and materials. www.greenguard.org
- **Level 2 Certified**

WORKSURFACES

- All worksurfaces are 1" thick, constructed of 45 lb. density particleboard covered on both sides with high performance, thermally fused laminate
- Worksurfaces feature Global's preferred matching edge detail on all sides
- High Pressure Tops are available in all SWAP laminate finishes at an extended lead time. Please see model # for pricing and availability
- High pressure tops are recommended for café applications and other high use areas
- Worksurfaces of 96" or less in length are standard in one piece (one carton).
Worksurfaces 120" to 144" in length are standard in two pieces (two cartons).

BASES

- Caution: to meet BIFMA standards for performance and stability, appropriate base size must be specified with corresponding top sizes identified. Top plates vary by base size and will only work with top sizes as referenced on the following pages.
- Bases are constructed of a ½" steel metal plate for counter balance, covered with a finished steel shroud, affixed with four bolts to a 3" diameter cold rolled steel tube.
- GRB22, GRB22H35, GRB22H41, GSB19, GSB19H35 and GSB19H41 attach to tops with a 6"x6" steel plate, welded to the 3" tube.
- GRB28, GRB34, GSB23 and GSB28 attach to tops with an 11" x 11" steel plate, welded to the 3" tube.
- Bases are available PAINTED in Black (BLK), Tungsten (TUN) and Designer White (DWT). Paint has a "sandtex" finish for extra durability.
- Bases are available in Chrome (CH) or Brushed Chrome (BCH) at an upcharge and with an extended lead time. Please see model # for pricing.
- All bases come with six ½" height adjustable glides for leveling on uneven floors
- Seated height bases with 3" dia x 27"h column, 0.6" base and 3/8"h levelers.
- Counter height bases with 3" dia x 34"h column, 0.6" base and 3/8"h levelers.
- Bar height bases with 3" dia x 39.5"h column, 0.6" base and 3/8"h levelers.

1. SPECIFY MODEL NUMBER

2. SPECIFY FINISH

Laminate Finishes:

ACJ Absolute Acajou	ASN Asian Night
AWC Avant Cherry	AWH Avant Honey
BLK Black	BRC Brushed Cobalt
CSJ Constellation Java	DES Dark Espresso
GRY Grey	HGT Hayden Grey
QTM Quartered Mahogany	SKC Shaker Cherry
SOG Storm Grey	TFW Tiger Fruitwood
TMA Tiger Mahogany	TMP Tiger Maple
TWL Tiger Walnut	WHT White
WHC* White Chocolate	WGY Willow Grey
WCR Winter Cherry	<i>*textured</i>

Bases (Painted):

BLK Black
TUN Tungsten
DWT Designer White

Bases (Plated):

CHM Polished Chrome
BCH Brushed Chrome

3. SPECIFY OPTIONS

GROMMETS

- Not all grommet locations are available on all combinations. Please refer to top/base chart on the following pages for more information.
- Optional Grommets available in standard table top locations, where available (left, center or right). Order as: **AG1, AG2 or AG3 - Add \$65**
- Grommet hole dimensions are 3 3/4" wide x 1 7/8" deep.
- Grommets may be placed at non-standard locations. Order as: **AGS - Add \$65**. A drawing must be supplied with vertical and horizontal dimensions to the center of the cut-out (as in drawing above). Please refer to CUSTOM GROMMET LOCATION FORM in the back reference section. Grommets may NOT be placed directly over the bases.

Grommet hole dimensions

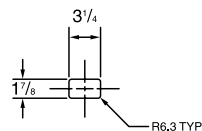

Grommet

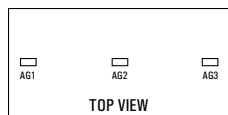
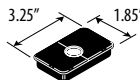

VILLA POWER BLOCK (CORDED VERSION ONLY)

- Not all power block locations are available on all combinations. Please refer to top/base chart on the following pages for more information.
- A Villa Power Block (corded) is available in four options (see page 670 for Villa Corded details). Villa Power Block (corded) dimensions vary by model. Villa cutout dimensions are 3" deep x 5 1/4" wide.
- A Villa cutout may be ordered in three standard locations, where available. Order as: **V1, V2 or V3 - Add \$65 for each cutout**.
- To purchase a Villa Power Block (corded), you must specify both the Villa cut-out location and the Villa model #. Order Villa Power Block separately - see page 670 for pricing and details.
- Villa Power Block (corded) cutouts may be placed in non-standard locations. Order as **VS - Add \$65**. A drawing must be supplied with vertical and horizontal dimensions to the center of the cutout. Please refer to the CUSTOM GROMMET LOCATION FORM in the back reference section. Cutouts may NOT be placed directly over the bases.

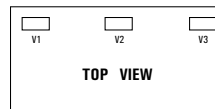

POWER BLOCK (PMSPDM)

- Not all power block locations are available on all combinations. Please refer to top/base chart on the following pages for more information.
- A Power Block is a rectangular worksurface power/data module with one electrical duplex receptacle and two data (RJ45) receptacles. 9' black cord included.
- Power Block dimensions are 3 1/2" deep x 6 1/2" wide x 2 3/4" high.
- Power Block cutout dimensions are 2 3/4" deep x 6" wide.
- A Power Block Cutout for model **PMSPDM** may be ordered in three standard locations, where available. Order as **E1, E2 or E3. Add \$65**.
- To purchase a Power Block, you must specify both the Power Block cut-out location and the Power Block model #. Order Power Block separately as **PMSPDM, Add \$238**.
- Power Block (PMSPDM) cutouts may be placed in non-standard locations. Order as **ES - Add \$65**. A drawing must be supplied with vertical and horizontal dimensions to the center of the cutout. Please refer to the CUSTOM GROMMET LOCATION FORM in the back reference section. Cutouts may NOT be placed directly over the bases.

Power Block

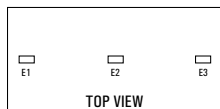
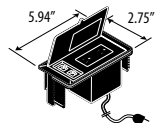

















OASIS MINI CUTOUTS

- Not all power block locations are available on all combinations. Please refer to top/base chart on the following pages for more information.
- Optional Oasis Mini cutouts are available in standard table top locations, where available (left, center or right). Order as **M1, M2 or M3 - Add \$65**.
- To purchase an Oasis Mini, you must specify both the Oasis Mini cutout location and the Oasis Mini model #. Order Oasis Mini separately - see page 604 for pricing and details.
- Mini Oasis cutouts may be placed in non-standard locations. Order as **MS - Add \$65**. A drawing must be supplied with vertical and horizontal dimensions to the center of the cutout. Please refer to the CUSTOM GROMMET LOCATION FORM in the back reference section. Cutouts may NOT be placed directly over the bases.



S SWAP TABLES - NOTES

APPLICABLE BASE OPTIONS FOR CORRESPONDING TOP										POWER MGMT OPTIONS
Table Shape	Top #	Seated Height 29"h		Counter Height 36"		Bar Height 41.5"		Base Qty.	# top pieces	Grommet + Power Block Cutouts Available
		Round base 	Square base 	Round base 	Square base 	Round base 	Square base 			
Round  *Nominal base plate dimension indicated by 4th and 5th characters in base model numbers.										
24" diameter	GRBTP24	GRB22	GSB19	GRB22H35	GSB19H35	GRB22H41	GSB19H41	1	1	None
30" diameter	GRBTP30	GRB22	GSB19	GRB22H35	GSB19H35	GRB22H41	GSB19H41	1	1	None
36" diameter	GRBTP36	GRB22	GSB19	GRB22H35	GSB19H35	GRB22H41	GSB19H41	1	1	None
42" diameter	GRBTP42	GRB28	GSB23	N/A	N/A	N/A		1	1	None
48" diameter	GRBTP48	GRB28	GSB23	N/A	N/A	N/A		1	1	None
54" diameter	GRBTP54	GRB34	GSB28	N/A	N/A	N/A		1	1	None
60" diameter	GRBTP60	GRB34	GSB28	N/A	N/A	N/A		1	1	None
Square 										
24" square	GSBTP24	GRB22	GSB19	GRB22H35	GSB19H35	GRB22H41	GSB19H41	1	1	None
30" square	GSBTP30	GRB22	GSB19	GRB22H35	GSB19H35	GRB22H41	GSB19H41	1	1	None
36" square	GSBTP36	GRB22	GSB19	GRB22H35	GSB19H35	GRB22H41	GSB19H41	1	1	None
42" square	GSBTP42	GRB28	GSB23	N/A	N/A	N/A	N/A	1	1	None
Rectangular 										
60x30 Rectangular top	GRT5NTP	GRB22	GSB19	GRB22H35	GSB19H35	GRB22H41	GSB19H41	2	1	Centered - E2, M2, V2
72x30 Rectangular top	GRT6NTP	GRB22	GSB19	GRB22H35	GSB19H35	GRB22H41	GSB19H41	2	1	
72x36 Rectangular top	GRT6TP	GRB22	GSB19	GRB22H35	GSB19H35	GRB22H41	GSB19H41	2	1	
84x30 Rectangular top	GRT7NTP	GRB22	GSB19	GRB22H35	GSB19H35	GRB22H41	GSB19H41	2	1	3 positions - Left/ Center/Right (E1, E2, E3; V1/2/3; M1/2/3)
84x36 Rectangular top	GRT7TP	GRB22	GSB19	GRB22H35	GSB19H35	GRB22H41	GSB19H41	2	1	
96x30 Rectangular top	GRT8NTP	GRB22	GSB19	GRB22H35	GSB19H35	GRB22H41	GSB19H41	2	1	
96x36 Rectangular top	GRT8TP	GRB22	GSB19	GRB22H35	GSB19H35	GRB22H41	GSB19H41	2	1	
96x48 Rectangular top	GRT8WTP	GRB28	GSB23	N/A	N/A	N/A	N/A	2	1	
120x48 Rectangular top	GRT10WTP	GRB28	GSB23	N/A	N/A	N/A	N/A	3	2	Both ends - E1 & E3; V1/3; M1/3
144x48 Rectangular top	GRT12WTP	GRB28	GSB23	N/A	N/A	N/A	N/A	3	2	
Racetrack  *Nominal base plate dimension indicated by 4th and 5th characters in base model numbers.										
60x30 Racetrack top	GRC5NTP	GRB22	GSB19	GRB22H35	GSB19H35	GRB22H41	GSB19H41	2	1	Centered - E2, M2, V2
72x30 Racetrack top	GRC6NTP	GRB22	GSB19	GRB22H35	GSB19H35	GRB22H41	GSB19H41	2	1	
72x36 Racetrack top	GRC6TP	GRB22	GSB19	GRB22H35	GSB19H35	GRB22H41	GSB19H41	2	1	
84x30 Racetrack top	GRC7NTP	GRB22	GSB19	GRB22H35	GSB19H35	GRB22H41	GSB19H41	2	1	3 positions - Left/ Centered/Right (E1, E2, E3; V1/2/3; M1/2/3)
84x36 Racetrack top	GRC7TP	GRB22	GSB19	GRB22H35	GSB19H35	GRB22H41	GSB19H41	2	1	
96x30 Racetrack top	GRC8NTP	GRB22	GSB19	GRB22H35	GSB19H35	GRB22H41	GSB19H41	2	1	
96x36 Racetrack top	GRC8TP	GRB22	GSB19	GRB22H35	GSB19H35	GRB22H41	GSB19H41	2	1	
96x48 Racetrack top	GRC8WTP	GRB28	GSB23	N/A	N/A	N/A	N/A	2	1	
120x48 Racetrack top	GRC10WTP	GRB28	GSB23	N/A	N/A	N/A	N/A	3	2	Both ends - E1 & E3; V1/3; M1/3
144x48 Racetrack top	GRC12WTP	GRB28	GSB23	N/A	N/A	N/A	N/A	3	2	

APPLICABLE BASE OPTIONS FOR CORRESPONDING TOP										POWER MGMT OPTIONS
Table Shape	Top #	Seated Height 29"h		Counter Height 36"		Bar Height 41.5"		Base Qty.	# top pieces	Grommet + Power Block Cutouts Available
		Round base	Square base	Round base	Square base	Round base	Square base			
Boat Shape 										
60x30 Boat shape top	GBT5NTP	GRB22	GSB19	GRB22H35	GSB19H35	GRB22H41	GSB19H41	2	1	Centered - E2, M2, V2
72x30 Boat shape top	GBT6NTP	GRB22	GSB19	GRB22H35	GSB19H35	GRB22H41	GSB19H41	2	1	
72x36 Boat shape top	GBT6TP	GRB22	GSB19	GRB22H35	GSB19H35	GRB22H41	GSB19H41	2	1	
84x30 Boat shape top	GBT7NTP	GRB22	GSB19	GRB22H35	GSB19H35	GRB22H41	GSB19H41	2	1	3 positions - Left/ Centered/Right (E1, E2, E3; V1/2/3; M1/2/3)
84x36 Boat shape top	GBT7TP	GRB22	GSB19	GRB22H35	GSB19H35	GRB22H41	GSB19H41	2	1	
96x30 Boat shape top	GBT8NTP	GRB22	GSB19	GRB22H35	GSB19H35	GRB22H41	GSB19H41	2	1	
96x36 Boat shape top	GBT8TP	GRB22	GSB19	GRB22H35	GSB19H35	GRB22H41	GSB19H41	2	1	
96x48 Boat shape top	GBT8WTP	GRB28	GSB23	N/A	N/A	N/A	N/A	2	1	
120x48 Boat shape top	GBT10WTP	GRB28	GSB23	N/A	N/A	N/A	N/A	3	2	Both ends - E1 & E3; V1/3; M1/3
144x48 Boat shape top	GBT12WTP	GRB28	GSB23	N/A	N/A	N/A	N/A	3	2	

S SWAP TABLES

TABLE NOTES - ESTIMATED CAPACITY

- Use the following for determining the size of a round table and the number of chairs needed for a conference area. All estimates are based on an average chair width of 23" with a 4" clearance between chairs. Adjust accordingly for a different chair size.

D x W x H

Top Size	Round	Square	Rectangular	Boat	Racetrack
24x24	2	2	N/A	N/A	N/A
30x30	3	4	N/A	N/A	N/A
36x36	4	4	N/A	N/A	N/A
42x42	4	4	N/A	N/A	N/A
48x48	4	4	N/A	N/A	N/A
54x54	5	6	N/A	N/A	N/A
60x60	5	6	N/A	N/A	N/A
30x60	N/A	N/A	4-6	4-6	4-6
30x72	N/A	N/A	4-6	4-6	4-6
30x84	N/A	N/A	4-6	4-6	4-6
30x96	N/A	N/A	6-8	6-8	6-8
36x72	N/A	N/A	4-6	4-6	4-6
36x84	N/A	N/A	4-6	4-6	4-6
36x96	N/A	N/A	6-8	6-8	6-8
44x84	N/A	N/A	6-8	6-8	6-8
48x96	N/A	N/A	6-8	6-8	6-8
48x120	N/A	N/A	8-10	8-10	8-10
48x144	N/A	N/A	10-12	10-12	10-12

Required Specifications

Top Finish
Base Finish

Optional Specifications

High Pressure Laminate Top
Chrome base



Round Tops

MODEL#	DIMENSIONS	FREIGHT CLASS	WT./LBS.	CUBIC FT.	LIST PRICE	HP ADD	CHROME ADD
D x W x H							
GRBTP24	24 x 24 x 1	70	20	1	\$172	\$86	n/a
GRBTP30	30 x 30 x 1	70	29	1.50	\$200	\$100	n/a
GRBTP36	36 x 36 x 1	70	40	2	\$255	\$128	n/a

Tops feature metal inserts for ease of assembly to base. One base required.

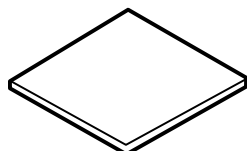

Square Tops

GSBTP24	24 x 24 x 1	70	48	2.50	\$176	\$89	n/a
GSBTP30	30 x 30 x 1	70	31	1.50	\$206	\$103	n/a
GSBTP36	36 x 36 x 1	70	42	2	\$262	\$131	n/a

Tops feature metal inserts for ease of assembly to base. One base required.

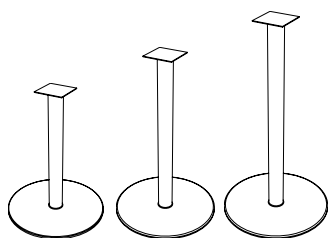

Round Bases

BASES FOR ROUND AND SQUARE TOPS - 24" to 36" wide

GRB22	22 x 22 x 28	150	55	9.33	\$565	n/a	\$93
GRB22H35	22 x 22 x 35	150	57.10	12	\$593	n/a	\$102
GRB22H41	22 x 22 x 40.5	150	58.30	14	\$602	n/a	\$107

- GRB22** - Seated height
- GRB22H35** - Counter height
- GRB22H41** - Bar height

Bases come fully assembled. Screws included with base for attaching to appropriate top(s). Chrome finishes are available at an upcharge.

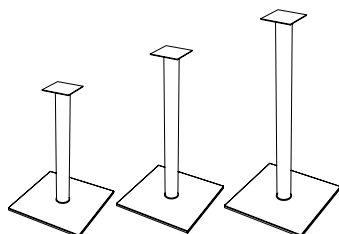

Square Bases

GSB19	19 x 19 x 28	100	50	6.06	\$612	n/a	\$84
GSB19H35	19 x 19 x 35	125	51.80	7.52	\$649	n/a	\$93
GSB19H41	19 x 19 x 40.5	125	53.20	8.77	\$672	n/a	\$102

- GSB19** - Seated height
- GSB19H35** - Counter height
- GSB19H41** - Bar height

Bases come fully assembled. Screws included with base for attaching to appropriate top(s). Chrome finishes are available at an upcharge.

Required Specifications

Top Finish
Base Finish

Optional Specifications

High Pressure Laminate Top
Chrome base

S SWAP TABLES



Round Tops

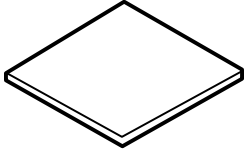

Square Tops

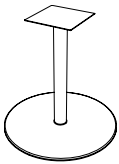

Round Base

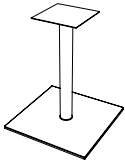

Square Base

MODEL#	DIMENSIONS D x W x H	FREIGHT CLASS	WT./LBS.	CUBIC FT.	LIST PRICE	HP ADD	CHROME ADD
GRBTP42	42 x 42 x 1	70	48	2.50	\$355	\$178	n/a
GRBTP48	48 x 48 x 1	70	64	3	\$380	\$190	n/a

Tops feature metal inserts for ease of assembly to base. One base required.

GSBTP42	42 x 42 x 1	70	50	2.50	\$363	\$182	n/a
---------	-------------	----	----	------	--------------	--------------	-----

Tops feature metal inserts for ease of assembly to base. One base required.

BASES FOR ROUND AND SQUARE TOPS - 42" to 48" wide.

GRB28	28 x 28 x 28	150	71.60	15.63	\$975	n/a	\$102
-------	--------------	-----	-------	-------	--------------	-----	--------------

Seated height. Bases come fully assembled. Screws included with base for attaching to appropriate top(s). Chrome finishes are available at an upcharge.

GSB23	19 x 19 x 28	125	58.30	9.33	\$896	n/a	\$56
-------	--------------	-----	-------	------	--------------	-----	-------------

Seated height. Bases come fully assembled. Screws included with base for attaching to appropriate top(s). Chrome finishes are available at an upcharge.

Required Specifications

Top Finish
Base Finish

Optional Specifications

High Pressure Laminate Top
Chrome base



Round Tops

MODEL#	DIMENSIONS	FREIGHT CLASS	WT./LBS.	CUBIC FT.	LIST PRICE	HP ADD	CHROME ADD
	D x W x H						
GRBTP54	54 x 54 x 1	70	78	3.75	\$508	\$254	n/a
GRBTP60	60 x 60 x 1	70	98	4.50	\$526	\$264	n/a

Tops feature metal inserts for ease of assembly to base. One base required.

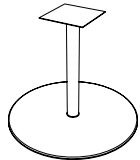

Round Base

BASES FOR ROUND TOPS - 54" to 60" wide

GRB34	34 x 34 x 28	150	94.10	20.56	\$1193	n/a	\$102
-------	--------------	-----	-------	-------	---------------	-----	--------------

Seated height. Bases come fully assembled. Screws included with base for attaching to appropriate top(s). Chrome finishes are available at an upcharge.

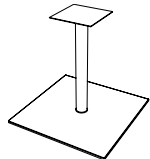

Square Base

GSB28	28 x 28 x 28	150	85.60	15.63	\$1114	n/a	\$47
-------	--------------	-----	-------	-------	---------------	-----	-------------

Seated height. Bases come fully assembled. Screws included with base for attaching to appropriate top(s). Chrome finishes are available at an upcharge.

Required Specifications

Top Finish
Base Finish

Optional Specifications

High Pressure Laminate Top
Chrome base

S SWAP TABLES

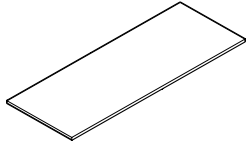

Rectangular Tops

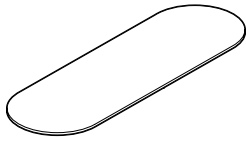

Racetrack Tops

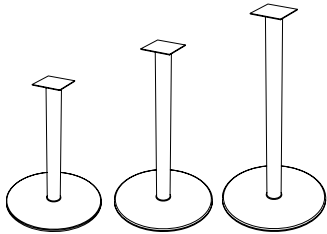

Round Bases

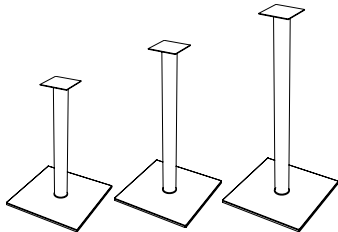

Square Bases

MODEL#	DIMENSIONS D x W x H	FREIGHT CLASS	WT./LBS.	CUBIC FT.	LIST PRICE	HP ADD	CHROME ADD
GRT5NTP	30 x 60 x 1	85	56	3.75	\$381	\$191	n/a
GRT6NTP	30 x 72 x 1	100	61	6.50	\$413	\$207	n/a
GRT6TP	36 x 72 x 1	92.5	75	7.50	\$476	\$238	n/a
GRT7NTP	30 x 84 x 1	100	72	7.50	\$515	\$258	n/a
GRT8NTP	30 x 96 x 1	100	80	8.50	\$561	\$281	n/a
GRT7TP	36 x 84 x 1	100	85	8.75	\$555	\$278	n/a
GRT8TP	36 x 96 x 1	92.5	94	9	\$607	\$304	n/a

One piece tops feature metal inserts for ease of assembly to base. Two bases required.

GRC5NTP	30 x 60 x 1	85	52	3.75	\$388	\$194	n/a
GRC6NTP	30 x 72 x 1	100	57	6.50	\$421	\$211	n/a
GRC6TP	36 x 72 x 1	100	71	7.50	\$485	\$243	n/a
GRC7NTP	30 x 84 x 1	100	68	7.50	\$525	\$263	n/a
GRC8NTP	30 x 96 x 1	100	76	8.50	\$572	\$286	n/a
GRC7TP	36 x 84 x 1	92.5	81	7.75	\$566	\$283	n/a
GRC8TP	36 x 96 x 1	92.5	91	9	\$619	\$310	n/a

One piece tops feature metal inserts for ease of assembly to base. Two bases required.

BASES FOR RECTANGULAR AND RACETRACK TOPS - 60" to 96" wide x 30" d and 36" d.

GRB22	22 x 22 x 28	150	55	9.33	\$565	n/a	\$93
GRB22H35	22 x 22 x 35	150	57.10	12	\$593	n/a	\$102
GRB22H41	22 x 22 x 40.5	150	58.30	14	\$602	n/a	\$107

- GRB22** - Seated height
- GRB22H35** - Counter height
- GRB22H41** - Bar height

Bases come fully assembled. Screws included with base for attaching to appropriate top(s). Chrome finishes are available at an upcharge.

GSB19	19 x 19 x 28	100	50	6.06	\$612	n/a	\$84
GSB19H35	19 x 19 x 35	125	51.80	7.52	\$649	n/a	\$93
GSB19H41	19 x 19 x 40.5	125	53.20	8.77	\$672	n/a	\$102

- GSB19** - Seated height
- GSB19H35** - Counter height
- GSB19H41** - Bar height

Bases come fully assembled. Screws included with base for attaching to appropriate top(s). Chrome finishes are available at an upcharge.

Required Specifications

Top Finish
Base Finish

Optional Specifications

High Pressure Laminate Top
Chrome base

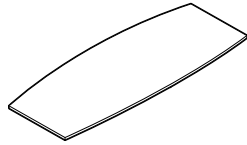

Boat Tops

MODEL#	DIMENSIONS	FREIGHT CLASS	WT/LBS.	CUBIC FT.	LIST PRICE	HP ADD	CHROME ADD
D x W x H							
GBT5NTP	30 x 60 x 1	85	52	3.75	\$388	\$194	n/a
GBT6NTP	30 x 72 x 1	100	57	6.50	\$421	\$211	n/a
GBT6TP	36 x 72 x 1	100	71	7.50	\$485	\$243	n/a
GBT7NTP	30 x 84 x 1	100	68	7.50	\$525	\$263	n/a
GBT8NTP	30 x 96 x 1	100	76	8.50	\$572	\$286	n/a
GBT7TP	36 x 84 x 1	100	81	8.75	\$566	\$283	n/a
GBT8TP	36 x 96 x 1	92.5	91	9	\$619	\$310	n/a

One piece tops feature metal inserts for ease of assembly to base. Two bases required.

BASES FOR BOAT SHAPED TOPS - 60" to 96" wide x 30"d and 36"d.

GRB22	22 x 22 x 28	150	55	9.33	\$565	n/a	\$93
GRB22H35	22 x 22 x 35	150	57.10	12	\$593	n/a	\$102
GRB22H41	22 x 22 x 40.5	150	58.30	14	\$602	n/a	\$107

- GRB22** - Seated height
- GRB22H35** - Counter height
- GRB22H41** - Bar height

Bases come fully assembled. Screws included with base for attaching to appropriate top(s). Chrome finishes are available at an upcharge.

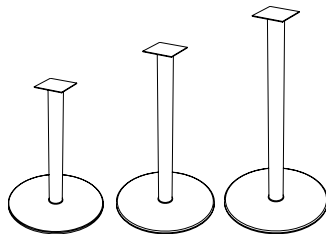

Round Bases

GSB19	19 x 19 x 28	100	50	6.06	\$612	n/a	\$84
GSB19H35	19 x 19 x 35	125	51.80	7.52	\$649	n/a	\$93
GSB19H41	19 x 19 x 40.5	125	53.20	8.77	\$672	n/a	\$102

- GSB19** - Seated height
- GSB19H35** - Counter height
- GSB19H41** - Bar height

Bases come fully assembled. Screws included with base for attaching to appropriate top(s). Chrome finishes are available at an upcharge.

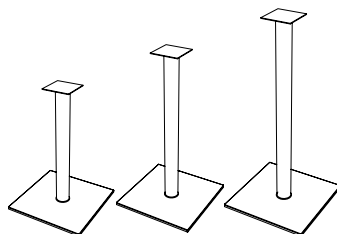

Square Bases

Required Specifications

Top Finish
Base Finish

Optional Specifications

High Pressure Laminate Top
Chrome base

S SWAP TABLES

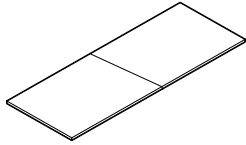

Rectangular Tops

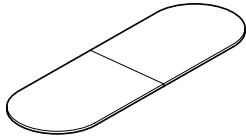

Racetrack Tops

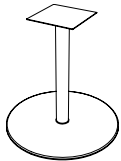

Round Base

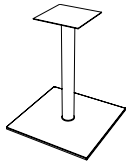

Square Base

MODEL# DIMENSIONS FREIGHT CLASS WT/LBS. CUBIC FT. LIST PRICE HP ADD CHROME ADD

D x W x H

1 Piece top - 2 bases required

GRT8WTP	48 x 96 x 1	100	122	14	\$1036	\$393	n/a
---------	-------------	-----	-----	----	---------------	--------------	-----

2 Piece tops - 3 bases required

GRT10WTP	48 x 120 x 1	150	160	36	\$1304	\$528	n/a
GRT12WTP	48 x 144 x 1	150	188	43	\$1519	\$597	n/a

Tops feature metal inserts for ease of assembly to base. Two bases required for one piece top. Three bases required for two piece top.

1 Piece top - 2 bases required

GRC8WTP	48 x 96 x 1	100	117	14	\$1036	\$401	n/a
---------	-------------	-----	-----	----	---------------	--------------	-----

2 Piece tops - 3 bases required

GRC10WTP	48 x 120 x 1	150	155	36	\$1304	\$538	n/a
GRC12WTP	48 x 144 x 1	150	183	43	\$1519	\$609	n/a

Tops feature metal inserts for ease of assembly to base. Two bases required for one piece top. Three bases required for two piece top.

BASES FOR RECTANGULAR AND RACETRACK TOPS - 96" to 144" wide x 48" d.

GRB28	28 x 28 x 28	150	71.60	15.63	\$975	n/a	\$102
-------	--------------	-----	-------	-------	--------------	-----	--------------

Seated height. Bases come fully assembled. Screws included with base for attaching to appropriate top(s). Chrome finishes are available at an upcharge.

GSB23	19 x 19 x 28	125	58.30	9.33	\$896	n/a	\$56
-------	--------------	-----	-------	------	--------------	-----	-------------

Seated height. Bases come fully assembled. Screws included with base for attaching to appropriate top(s). Chrome finishes are available at an upcharge.

Required Specifications

Top Finish
Base Finish

Optional Specifications

High Pressure Laminate Top
Chrome base

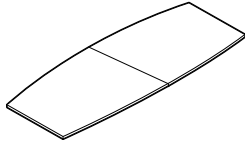

Boat Tops

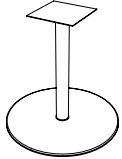

Round Base

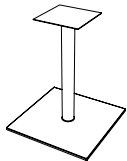

Square Base

MODEL#	DIMENSIONS	FREIGHT CLASS	WT/LBS.	CUBIC FT.	LIST PRICE	HP ADD	CHROME ADD
D x W x H							
1 Piece top - 2 bases required							
GBT8WTP	48 x 96 x 1	100	117	14	\$1036	\$401	n/a
2 Piece tops - 3 bases required							
GBT10WTP	48 x 120 x 1	150	155	36	\$1304	\$538	n/a
GBT12WTP	48 x 144 x 1	150	183	43	\$1519	\$609	n/a

Tops feature metal inserts for ease of assembly to base. Two bases required for one piece top. Three bases required for two piece top.

BASES FOR BOAT TOPS - 96" to 144" wide x 48" d.

GRB28	28 x 28 x 28	150	71.60	15.63	\$975	n/a	\$102
-------	--------------	-----	-------	-------	--------------	-----	--------------

Seated height. Bases come fully assembled. Screws included with base for attaching to appropriate top(s). Chrome finishes are available at an upcharge.

GSB23	19 x 19 x 28	125	58.30	9.33	\$896	n/a	\$56
-------	--------------	-----	-------	------	--------------	-----	-------------

Seated height. Bases come fully assembled. Screws included with base for attaching to appropriate top(s). Chrome finishes are available at an upcharge.

Required Specifications

Top Finish
Base Finish

Optional Specifications

High Pressure Laminate Top
Chrome base

C CITI TABLES

CITI TABLES MODEL# DIMENSIONS FREIGHT CLASS WT/LBS. CUBIC FT. LIST PRICE

D x W x H

Notes

- Citi tables complement the contemporary timeless decor of many offices.
- Legs are **standard** in Tungsten (**TUN**) and also available in Black (**BK**) finish at no charge. A Chrome (**CHM**) finish is available. **Add \$118.**
- Table tops are available in either tempered glass or laminate
- Citi tables are offered in the following finishes to coordinate with Global casegoods and wood seating:

ACJ	Absolute Acajou	ASN	Asian Night
AWC	Avant Cherry	AWH	Avant Honey
BLK	Black	BRC	Brushed Cobalt
CSJ	Constellation Java	DES	Dark Espresso
GRY	Grey	HGT	Hayden Grey
QTM	Quartered Mahogany	SKC	Shaker Cherry
SOG	Storm Grey	TFW	Tiger Fruitwood
TMA	Tiger Mahogany	TMP	Tiger Maple
TWL	Tiger Walnut	WHT	White
WHC	White Chocolate*	WGY	Willow Grey
WCR	Winter Cherry		<i>*textured</i>

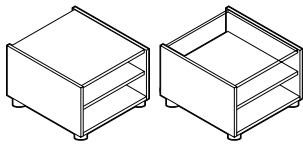

End Table

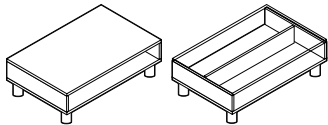

Coffee Table - Rectangular

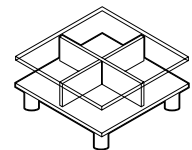

Coffee Table - Square

7885	20 x 24 x 20	100	53	6	\$531
------	--------------	-----	----	---	--------------

(laminate top)

7886	20 x 24 x 20	92.5	60	6	\$750
------	--------------	------	----	---	--------------

(glass top)

Metal tubular legs. Laminate or tempered glass tops available.

7887	20 x 40 x 15	100	60	6.50	\$553
------	--------------	-----	----	------	--------------

(laminate top)

7888	20 x 40 x 15	92.5	75	6.50	\$862
------	--------------	------	----	------	--------------

(glass top)

Metal tubular legs. Laminate or tempered glass tops available.

7889	33 x 33 x 15	92.5	90	8.75	\$1047
------	--------------	------	----	------	---------------

(glass top)

Metal tubular legs. Tempered glass top.

Required Specifications

Finish

COAT TREES



Coat Tree

MODEL#	DIMENSIONS	FREIGHT CLASS	WT/LBS.	CUBIC FT.	LIST PRICE
--------	------------	---------------	---------	-----------	------------

D x W x H

PCOS2	25 x 25 x 60	300	8	4.67	\$334
PCOS3	25 x 25 x 60	300	8	4.67	\$334

Square tube metal frame, complete with four Chrome double hooks. Adjustable glides. 60" high. Ships UPS.

- 3 per carton
- PCOS2 is finished in **Black**.
- PCOS3 is finished in **Chrome**.



Coat Tree

PCT	25 x 25 x 65	250	6	3	\$429
-----	--------------	-----	---	---	--------------

Square tube. Complete with four satin brass double hooks. 65" high. Available in the following finishes: Cherry (ACM), Honey (AHM), Maple (AVM), Black (BKM), English Oak (EOM), Mahogany (TMM), Fruitwood (TFM) and Walnut (TWM). Ships UPS.

- 1 per carton

VENEER COFFEE / END TABLES

Notes:

- JT tables are constructed of genuine oak faced veneers and maple solids.
- Tables shipped RTA (ready to assemble). Screws included. #2 square headed screwdriver required for assembly.

• Available finishes on **JT tables:**

Black (BKM)	Espresso Cafe (ECM)	English Oak (EOM)	Honey (AHM)	Medium Oak (MOO)	Tiger Mahogany (TMM)
Cherry (ACM)	Harvest Oak (HOO)	Maple (AVM)	Tiger Fruitwood (TFM)	Tiger Walnut (TWM)	

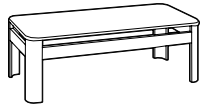

Coffee Table

JT1	22 x 46 x 15	250	22	9	\$1139
-----	--------------	-----	----	---	---------------

Molded plywood leg, frame and top with veneer finish. Rectangular.

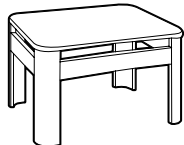

Coffee/Lamp Table

JT2	28 x 28 x 15	250	18	7	\$1043
-----	--------------	-----	----	---	---------------

Molded plywood leg, frame and top with veneer finish. Square.

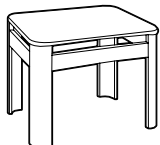

Lamp/End Table

JT3	21.75 x 21.75 x 19	250	14	6	\$941
-----	--------------------	-----	----	---	--------------

Molded plywood leg, frame and top with veneer finish.

Required Specifications

Finish

D DAWSON TABLES

DAWSON TABLES MODEL# DIMENSIONS FREIGHT CLASS WT/LBS. CUBIC FT. LIST PRICE

D x W x H

- Notes**
- Dawson tables feature elegant lines and details and were specifically created to offer a design-sensitive look that coordinates with the wood finishes and details of Global's lounge seating and casegoods.
 - Tapered hardwood legs and edges
 - Tops feature a sophisticated edge detail with frosted tempered safety glass or hardwood veneer inserts.
 - Offered in the following finishes to coordinate with Global casegoods and wood seating:

ACM	Cherry	BKM	Black	HOM	Harvest Oak on Maple	AVM	Maple
TMM	Mahogany	AHM	Honey	TFM	Fruitwood	TWM	Walnut
EOM	English Oak	ECM	Espresso Café				
 - Glass tops are 8 mm thick
 - Tempered glass is lightly frosted on the bottom side of the top to create a slightly translucent look. The top side of the glass is not frosted to insure ease of cleaning.
 - Shipped fully assembled.

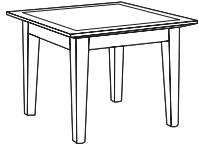

Square End Table

3374-G (glass top)	22 x 22 x 17	150	27	6.75	\$1005
-----------------------	--------------	-----	----	------	---------------

3374-W (veneer top)	22 x 22 x 17	150	30	6.75	\$957
------------------------	--------------	-----	----	------	--------------

Tapered hardwood edge with tapered legs.

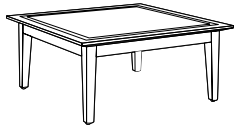

Square Coffee/Corner Table

3375-G (glass top)	33 x 33 x 15	250	43	13.25	\$1463
-----------------------	--------------	-----	----	-------	---------------

3375-W (veneer top)	33 x 33 x 15	250	46	13.25	\$1343
------------------------	--------------	-----	----	-------	---------------

Tapered hardwood edge with tapered legs.

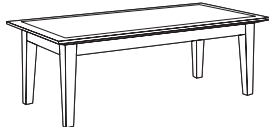

Rectangular Coffee Table

3376-G (glass top)	42 x 21 x 15	150	45	11	\$1463
-----------------------	--------------	-----	----	----	---------------

3376-W (veneer top)	42 x 21 x 15	150	48	11	\$1343
------------------------	--------------	-----	----	----	---------------

Tapered hardwood edge with tapered legs.

Required Specifications

Finish

FOLDING TABLES	MODEL#	DIMENSIONS D x W x H	FREIGHT CLASS	WT./LBS.	CUBIC FT.	LIST PRICE
----------------	--------	-------------------------	---------------	----------	-----------	------------

Notes:

- Sturdy and convenient.
- Available finishes:
 Light Oak (O) with Brown (BN) legs/skirt, Brown (BN) edge (**GFMT tables ONLY**)
 Walnut (W) with Brown (BN) legs/skirt, Brown (BN) edge
 Grey (GRY) with Grey (GRY) legs/skirt, Black (BK) edge (**GFMT & GFFT tables ONLY**)
 Grey (GRY) with Black (BLK) legs/skirt, Black (BK) edge (**GNFFT tables ONLY**)

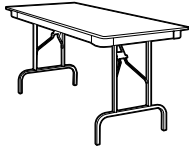

Rectangular Folding Table

GFFT1872	18 x 72 x 29	100	35	4	\$203
GFFT3060	30 x 60 x 29	92.5	47	4	\$214
GFFT3072	30 x 72 x 29	92.5	57	5	\$229
GFFT3096	30 x 96 x 29	92.5	70	7	\$281

5/8" **decorative surface top** with molded plastic corner pieces. Black "T" mold edging and full 1 5/8" skirt. Epoxy powder coated tubular leg with locking mechanism. 3/4" square legs.

- **GFFT tables are NOT available in Light Oak (O).**



Circular Folding Table

GFFTR60D	0 x 60 x 29	92.5	80	8	\$348
----------	-------------	------	----	---	--------------

5/8" **decorative surface top** with molded plastic corner pieces. Black "T" mold edging and full 1 5/8" skirt. Epoxy powder coated tubular leg with locking mechanism. 3/4" square legs.

- **GFFT tables are NOT available in Light Oak (O).**

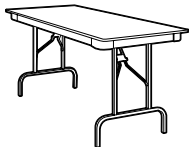

Rectangular Folding Table

GFMT1872	18 x 72 x 29	100	35	4	\$207
GFMT3060	30 x 60 x 29	92.5	47	4	\$220
GFMT3072	30 x 72 x 29	92.5	57	5	\$235
GFMT3096	30 x 96 x 29	92.5	70	7	\$271

5/8" **high performance thermally fused laminate top** with molded plastic corner pieces. Black "T" mold edging and full 1 5/8" skirt. Epoxy powder coated square leg with locking mechanism.



Circular Folding Table

GFMTR60D	0 x 60 x 29	92.5	80	8	\$378
----------	-------------	------	----	---	--------------

5/8" **high performance thermally fused laminate top** with molded plastic corner pieces. Black "T" mold edging and full 2 1/2" skirt. Epoxy powder coated square leg with locking mechanism.

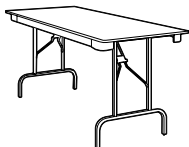

Rectangular Folding Table

GNFFT3060	30 x 60 x 29	92.5	47	4	\$166
GNFFT3072	30 x 72 x 29	92.5	57	5	\$172
GNFFT3096	30 x 96 x 29	92.5	70	7	\$238

5/8" **decorative surface top** with molded plastic corner pieces. "T" mold edging and protective plastic corners. Skirt runs the length of the table sides. Epoxy powder coated tubular leg with locking mechanism.

- **GNFFT tables are NOT available in Light Oak (O).**

- **Note:** Prices shown are for Global Distribution Center, not delivered pricing. All orders will be charged freight, except orders containing other Global products totalling \$2000 list or more, before adding folding tables and folding chairs. Any Inside Delivery & Set-up charge for these products must be quoted separately.

Required Specifications

Finish

F FOLDING TABLE DOLLY / LAMINATE OCCASIONAL TABLES

FOLDING TABLES

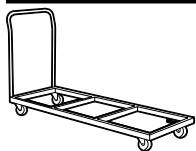

Table Dolly

MODEL#	DIMENSIONS D x W x H	FREIGHT CLASS	WT/LBS.	CUBIC FT.	LIST PRICE
FTD	82 x 26 x 7	250	55	20	\$956
FTD96	96 x 26 x 7	250	65	23.50	\$1150

Will accommodate up to 10 rectangular tables. **Will not accommodate circular tables.** Two swivel and two fixed 5" diameter casters. Removable handle for easy storage. 48"H with handle in place. 7"H without handle. Black only. Shipped RTA (ready to assemble).

- Casters are **NOT** for use on soft surfaces.

LAMINATE OCCASIONAL TABLES

Notes:

- Ideal for reception areas - colors coordinate with all Global desks, conference tables and accessories.
- Available to either match or coordinate with most Global laminate desk series. Available finishes.
- High pressure laminate exterior
- Premium cylinder tables have a flexible plywood core construction ideal for institutional and high traffic environments
- Adjustable glides are standard
- Ships one per carton.

ACJ	Absolute Acajou	ASN	Asian Night
AWC	Avant Cherry	AWH	Avant Honey
BLK	Black	BRC	Brushed Cobalt
CSJ	Constellation Java	DES	Dark Espresso
GRY	Grey	HGT	Hayden Grey
QTM	Quartered Mahogany	SKC	Shaker Cherry
SOG	Storm Grey	TFW	Tiger Fruitwood
TMA	Tiger Mahogany	TMP	Tiger Maple
TWL	Tiger Walnut	WHT	White
WHC	White Chocolate	WGY	Willow Grey
WCR	Winter Cherry		

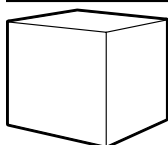

Cube Table

GCU1816	18 x 18 x 16	85	40	3.30	\$410
GCU1821	18 x 18 x 21	92.5	46	4	\$479
GCU2416	24 x 24 x 16	92.5	63	6	\$479
GCU2421	24 x 24 x 21	92.5	83	7	\$479

3/4" plywood covered in high pressure laminate. Plastic glides. **Flush base.**

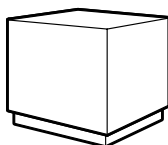

Plinth Cube Table

Gcup1816	18 x 18 x 16	85	40	3	\$453
Gcup1821	18 x 18 x 21	92.5	46	4	\$524
Gcup2416	24 x 24 x 16	92.5	63	6	\$524
Gcup2421	24 x 24 x 21	92.5	83	7	\$524

3/4" plywood covered in high pressure laminate. Plastic glides. **Recessed base.**

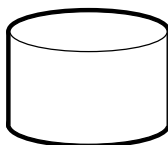

Cylinder Table

Gcy1816	18 x 18 x 16	85	43	3.30	\$410
Gcy1821	18 x 18 x 21	92.5	49	4.30	\$479
Gcy2416	24 x 24 x 16	125	47	6	\$479
Gcy2421	24 x 24 x 21	100	66	7	\$479
Gcy3016	30 x 30 x 16	125	59	8	\$545
Gcy3021	30 x 30 x 21	125	78	11	\$545

3/8" foundation board covered in high pressure laminate. Plastic glides. **Flush base.**

Required Specifications

Finish

LAMINATE OCCASIONAL TABLES

MODEL# DIMENSIONS FREIGHT CLASS WT/LBS. CUBIC FT. LIST PRICE

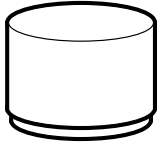

Plinth Cylinder Table

	D x W x H				
GCYP1816	18 x 18 x 16	85	43	3.30	\$453
GCYP1821	18 x 18 x 21	92.5	49	4.30	\$524
GCYP2416	24 x 24 x 16	125	47	6	\$524
GCYP2421	24 x 24 x 21	100	66	7	\$524
GCYP3016	30 x 30 x 16	125	59	8	\$597
GCYP3021	30 x 30 x 21	125	78	11	\$597

3/8" foundation board covered in high pressure laminate. Plastic glides. **Recessed base.**

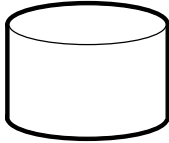

Premium Cylinder Table

CPFD1816	18 x 18 x 16	150	30	7	\$727
CPFD1821	18 x 18 x 21	150	30	7	\$747
CPFD2416	24 x 24 x 16	250	42	11.50	\$755
CPFD2421	24 x 24 x 21	250	42	11.50	\$774
CPFD3016	30 x 30 x 16	250	52	17	\$854
CPFD3021	30 x 30 x 21	250	52	17	\$941

3/4" plywood covered in high pressure laminate. Plastic glides. **Flush base.**

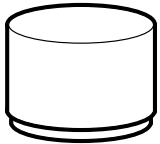

Premium Plinth Cylinder Table

CPPD1816	18 x 18 x 16	150	30	7	\$765
CPPD1821	18 x 18 x 21	150	30	7	\$785
CPPD2416	24 x 24 x 16	250	42	11.50	\$793
CPPD2421	24 x 24 x 21	250	42	11.50	\$812
CPPD3016	30 x 30 x 16	250	52	17	\$906
CPPD3021	30 x 30 x 21	250	52	17	\$994

3/4" plywood covered in high pressure laminate. Plastic glides. **Recessed base.**

Required Specifications

Finish

L LITE LIFT II

LITE LIFT II FOLDING TABLES

MODEL#

DIMENSIONS

FREIGHT CLASS

WT/LBS.

CUBIC FT.

LIST PRICE

D x W x H

Notes:

- Lightweight construction allows tables to easily and safely be lifted and moved by one person.
- Polypropylene top is fully water resistant and easy to clean and maintain.
- Thick, high impact radius corner helps protect individuals from injury.
- Folding legs automatically lock by a gravity activated mechanism when opened.
- Non-marring plastic glides protect floors from scratching when tables are moved.
- Structural side aprons allow tables to easily stack.
- Lite Lift II tables pass all BIFMA standards for strength and stability.
- **Available in Oyster Grey finish only.**



FRT48

FRT60B-FRT96B

Rectangular Folding Table

FRT48B	24 x 48 x 29.25	85	23	1.57	\$195
FRT60B	30 x 60 x 29.25	92.5	30	2.54	\$238
FRT72B	30 x 72 x 29.25	92.5	36	3.06	\$259
FRT96B	30 x 96 x 29.25	92.5	50	4.79	\$352

Lightweight, textured, polypropylene Oyster Grey finish top. High impact radius corners. 19 gauge 11/8" diameter steel tubular legs with welded crossbars automatically lock. Legs finished in scuff resistant textured Charcoal Grey epoxy paint. Shipped fully assembled.

- Available in Oyster Grey finish with Charcoal Grey legs only.
- **Note:** Prices shown are for Global Distribution Center, not delivered pricing. All orders will be charged freight, except orders containing other Global products totalling \$2,000 list or more, before adding folding tables and folding chairs. Any Inside Delivery & Set-up charge for these products must be quoted separately.

Required Specifications

Finish

RECEPTION TABLES	MODEL#	DIMENSIONS D x W x H	FREIGHT CLASS	WT/LBS.	CUBIC FT.	LIST PRICE
------------------	--------	-------------------------	---------------	---------	-----------	------------

Notes:

• Available to either match or coordinate with most Global laminate desk series. Available finishes:

ACJ	Absolute Acajou	ASN	Asian Night
AWC	Avant Cherry	AWH	Avant Honey
BLK	Black	BRC	Brushed Cobalt
CSJ	Constellation Java	DES	Dark Espresso
GRY	Grey	HGT	Hayden Grey
QTM	Quartered Mahogany	SKC	Shaker Cherry
SOG	Storm Grey	TFW	Tiger Fruitwood
TMA	Tiger Mahogany	TMP	Tiger Maple
TWL	Tiger Walnut	WHT	White
WHC	White Chocolate	WGY	Willow Grey
WCR	Winter Cherry		

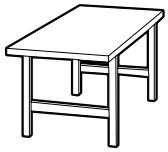

Reception Table - H Legs

H18	18 x 18 x 17.37	250	22	5.78	\$258
H24	24 x 24 x 17.37	250	20	5.40	\$224
H30	30 x 30 x 17.37	250	22	5.80	\$294
H36	36 x 36 x 17.37	250	24	6.62	\$378

1" high performance thermally fused laminate with self-edge. **Square top with chrome H-legs.** Shipped RTA (ready to assemble).

- Tables are 16" high reception height.



Reception Table - Blade Pedestal Legs

GPR24	24 x 24 x 17	250	18	6	\$250
GPR30	30 x 30 x 17	150	24	6	\$321
GPR36	36 x 36 x 17	250	25	7	\$398

1" high performance thermally fused laminate with self-edge. **Circular top with chrome blade pedestal legs and leveling glides.** Shipped RTA (ready to assemble).

- Tables are 17" high reception height.



Reception Table - Blade Pedestal Legs

GPS18	18 x 18 x 17	250	24	7	\$277
GPS24	24 x 24 x 17	250	20	6	\$250
GPS30	30 x 30 x 17	150	25	6	\$321
GPS36	36 x 36 x 17	150	29	7	\$398

1" high performance thermally fused laminate with self-edge. **Square top with chrome blade pedestal legs and leveling glides.** Shipped RTA (ready to assemble).

- Tables are 17" high reception height.



Reception Table - Tubular Legs

GPRR24	24 x 24 x 17	250	18	6	\$361
GPRR30	30 x 30 x 17	150	24	6	\$425
GPRR36	36 x 36 x 17	250	25	7	\$507

1" high performance thermally fused laminate with self-edge. **Circular top with chrome tubular legs and leveling glides.** Shipped RTA (ready to assemble).

- Tables are 17" high reception height.

Required Specifications

Finish

R RECEPTION TABLES

RECEPTION TABLES

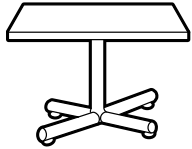

Reception Table - Tubular Legs

MODEL#	DIMENSIONS D x W x H	FREIGHT CLASS	WT/LBS.	CUBIC FT.	LIST PRICE
GPRS24	24 x 24 x 17	125	20	3	\$361
GPRS30	30 x 30 x 17	100	25	3	\$428
GPRS36	36 x 36 x 17	100	29	3.50	\$514

1" high performance thermally fused laminate with self-edge. **Square top with chrome tubular legs and leveling glides.** Shipped RTA (ready to assemble).

- Tables are 17" high reception height.

RECTANGULAR TABLE

Notes:

- Available to either match or coordinate with most Global laminate desk series. Available finishes. Black (**BLK**), Grey (**GRY**), Tiger Walnut (**TWL**)
- Legs available in Chrome or Black

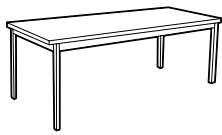

Rectangular Table

GATMS6030	30 x 60 x 29	70	132	8	\$460
GATMS7230	30 x 72 x 29	92.5	87	8	\$525
GATMS7236	36 x 72 x 29	70	132	8	\$648
GATMS8436	36 x 84 x 29	70	153	8	\$828
GATMS9648	48 x 96 x 29	65	214	8	\$872

1" high performance thermally fused thick plastic laminate top with self edge and Black metal skirt. Chrome or Black legs with adjustable glides. Shipped RTA (ready to assemble).

Required Specifications

Finish

SIRENA TABLES	MODEL#	DIMENSIONS D x W x H	FREIGHT CLASS	WT/LBS.	CUBIC FT.	LIST PRICE
---------------	--------	-------------------------	---------------	---------	-----------	------------

- Modern tables for reception areas, meeting rooms, and private office use.
- Sirena tables are offered in the following finishes to coordinate with Global casegoods and wood seating:

ACJ	Absolute Acajou	ASN	Asian Night
AWC	Avant Cherry	AWH	Avant Honey
DES	Dark Espresso	HGT	Hayden Gray
SKC	Shaker Cherry	TMA	Tiger Mahogany
TMP	Tiger Maple	TWL	Tiger Walnut
WHT	White	WHC	White Chocolate
WCR	Winter Cherry		
- Optional high pressure laminate top at 20% upcharge for the following finishes Tiger Maple (**TMP**), Tiger Fruitwood (**TFW**), Avant Cherry (**AWC**), and Avant Honey (**AWH**). Please Specify.
- MDF tops are 3/4" thick and feature a refined edge with a round triangular profile and an epoxy finish. Offered in MDF Table tops, tablets and book shelves are also offered in Charcoal (**CHR**), Platinum (**PLT**), or White (**WHT**). Please specify.
- Laminate tops are 1 1/2" thick to coordinate with Global casegoods and wood seating
- Table legs are available in Tungsten (**TUN**), Charcoal (**CHR**), Black (**BLK**) at no upcharge. Not available in Chrome.
- Legs are 1 1/2" steel tubing, tapered toward the bottom of the leg to 7/8", equipped with self-leveling pivoting steel glide.

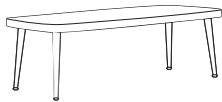

Coffee Table

3400 (laminate top)	22 x 48 x 15	250	52	17.25	\$1193
3406 (mdf top)	22 x 48 x 14.25	250	38	17.25	\$1451



Coffee Table

3401 (laminate top)	22 x 56 x 15	250	60	19.75	\$1319
3407 (mdf top)	22 x 56 x 14.25	250	44	19.75	\$1657



End Table

3402 (laminate top)	22 x 17 x 15	250	26	7.75	\$1298
3408 (mdf top)	22 x 17 x 14.25	250	20	7.75	\$1167

Required Specifications

Top Finish
Leg Finish

W WIND TABLES

WIND TABLES

MODEL#

DIMENSIONS

FREIGHT CLASS

WT/LBS.

CUBIC FT.

LIST PRICE

D x W x H

Notes:

- Wind tables complement the modern decor of many offices.
- Legs are standard in Chrome. Tungsten (**TUN**) and Charcoal (**CHR**) finishes are available at no upcharge.
- Table tops are available in two different finishes; MDF tops feature a refined edge with a rounded triangular profile and Epoxy finish. Available in Charcoal (**CHR**), White (**WHT**) and Platinum (**PLT**). Please Specify.
- Laminate tops are offered in the following finishes to coordinate with Global casegoods and wood seating:

ACJ	Absolute Acajou	ASN	Asian Night
AWC	Avant Cherry	AWH	Avant Honey
BLK	Black	BRC	Brushed Cobalt
CSJ	Constellation Java	DES	Dark Espresso
GRY	Grey	HGT	Hayden Grey
QTM	Quartered Mahogany	SKC	Shaker Cherry
SOG	Storm Grey	TFW	Tiger Fruitwood
TMA	Tiger Mahogany	TMP	Tiger Maple
TWL	Tiger Walnut	WHT	White
WHC	White Chocolate	WGY	Willow Grey
WCR	Winter Cherry		

- Table tops are available in high pressure laminate at a 20% upcharge.



Square Corner Table

3356	24 x 24 x 17	250	30	11.50	\$760
(MDF top)					

3366	24 x 24 x 17	250	36	11.50	\$598
(laminate top)					

Steel tubular base in Chrome finish. Tops are available with an mdf or laminate finish. MDF tops feature a refined edge with a rounded triangular profile and an epoxy finish.



Rectangular Coffee Table

3357	20 x 48 x 15	250	43	16	\$988
(MDF top)					

3367	20 x 48 x 15	250	52	16	\$791
(laminate top)					

Steel tubular base in Chrome finish. Tops are available with an mdf or laminate finish. MDF tops feature a refined edge with a rounded triangular profile and an epoxy finish.



Square Coffee Table

3358	36 x 36 x 15	250	54	22	\$1253
(MDF top)					

3368	36 x 36 x 15	250	66	22	\$1072
(laminate top)					

Steel tubular base in Chrome finish. Tops are available with an mdf or laminate finish. MDF tops feature a refined edge with a rounded triangular profile and an epoxy finish.



Round Corner Table



3860	24 x 24 x 17	250	30	11.50	\$944
(MDF top)					

3870	24 x 24 x 17	250	35	11.50	\$655
(laminate top)					

Steel tubular base in Chrome finish. Tops are available with an mdf or laminate finish. MDF tops feature a refined edge with a rounded triangular profile and an epoxy finish.

Required Specifications

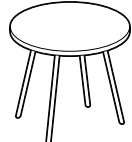
Finish

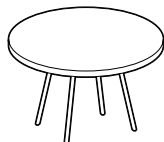
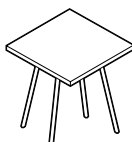
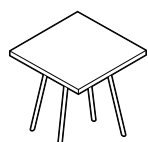
WIND TABLES	MODEL#	DIMENSIONS	FREIGHT CLASS	WT/LBS.	CUBIC FT.	LIST PRICE
 Round Coffee Table	3861 (MDF top)	36 x 36 x 15	250	52	22	\$1378
	3871 (laminated top)	36 x 36 x 15	250	57	22	\$965
Steel tubular base in Chrome finish. Tops are available with an mdf or laminate finish. MDF tops feature a refined edge with a rounded triangular profile and an epoxy finish.						
 Round Meeting/Dining Table - 30" dia.	3862 (MDF top)	30 x 30 x 29.5	125	57	8.75	\$1438
	3872 (laminated top)	30 x 30 x 29.5	125	62	8.75	\$1104
Steel tubular base in Chrome finish. Tops are available with an mdf or laminate finish. MDF tops feature a refined edge with a rounded triangular profile and an epoxy finish.						
 Round Meeting/Dining Table - 36" dia.	3863 (MDF top)	36 x 36 x 29.5	150	62	11.50	\$1702
	3873 (laminated top)	36 x 36 x 29.5	150	67	11.50	\$1332
Steel tubular base in Chrome finish. Tops are available with an mdf or laminate finish. MDF tops feature a refined edge with a rounded triangular profile and an epoxy finish.						
 Round Meeting/Dining Table - 42" dia.	3864 (MDF top)	42 x 42 x 29.5	150	67	15	\$2166
	3874 (laminated top)	42 x 42 x 29.5	150	72	15	\$1508
Steel tubular base in Chrome finish. Tops are available with an mdf or laminate finish. MDF tops feature a refined edge with a rounded triangular profile and an epoxy finish.						
 Square Meeting/Dining Table - 30"	3865 (MDF top)	30 x 30 x 29.5	150	57	11.50	\$1543
	3875 (laminated top)	30 x 30 x 29.5	150	62	11.50	\$1211
Steel tubular base in Chrome finish. Tops are available with an mdf or laminate finish. MDF tops feature a refined edge with a rounded triangular profile and an epoxy finish.						
 Square Meeting/Dining Table - 36"	3866 (MDF top)	36 x 36 x 29.5	150	62	15	\$1720
	3876 (laminated top)	36 x 36 x 29.5	150	67	15	\$1350
Steel tubular base in Chrome finish. Tops are available with an mdf or laminate finish. MDF tops feature a refined edge with a rounded triangular profile and an epoxy finish.						

Required Specifications

Finish

W WIND TABLES

WIND TABLES

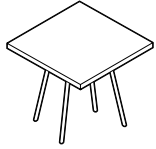

Square Meeting/Dining Table - 42"

MODEL#	DIMENSIONS	FREIGHT CLASS	WT/LBS.	CUBIC FT.	LIST PRICE
--------	------------	---------------	---------	-----------	------------

D x W x H

3867 (MDF top)	42 x 42 x 29.5	250	67	17.75	\$2222
3877 (lamine top)	42 x 42 x 29.5	150	72	17.75	\$1519

Steel tubular base in Chrome finish. Tops are available with an mdf or laminate finish. MDF tops feature a refined edge with a rounded triangular profile and an epoxy finish.

Required Specifications

Finish

filing + storage



Files

654

global



Global's wide variety of lateral files can satisfy every price point and individual style. Choose from center or full pulls, fixed or receding drawer fronts, various size drawer openings and a range of colors to coordinate with any office.

1900P Series

Features an angled full pull and smooth, seamless welded corners. Counterweight is standard. Fixed front drawers. Drawers are 12" high.

9300P Series

Features a looped full pull for convenient opening and upscale appearance. Smooth, seamless welded corners provide lasting strength and durability. Available with both fixed or receding doors.

9300 Series

Features a center pull and seamless welded corners to provide lasting strength and durability. Available with both fixed or receding doors.

9700 Series

Features slimline satin aluminum handles and full welded seamless corners. Fixed front drawers.

9100P Series

Features a looped full pull and full welded seamless tops to improve strength and appearance. Drawer fronts also have a welded reinforcement channel for additional strength. Available with fixed or receding doors, as well as models that feature all drawers with extra large openings to accommodate binders.

9100 Series

Features a center pull and full welded seamless tops to improve strength and appearance. Available with both fixed or receding doors.

1200 Series

Features a looped full pull and soft touch HytreTM handles. Accessories such as Posting Shelves, Half-Height Drawers, Receding Doors and "B" openings. Also available with electronic locks.

Blocks Series

Create a custom two-sided workspace with a variety of Upper, Lower & Middle Blocks.



Features and Benefits

- Standard locks with removable cores for keying alike
- Standard lock bars on both sides of cabinet provide increased security
- Positive interlocking system prevents tipping by allowing only one drawer to open at a time
- Full extension ball bearing suspensions
- "B" openings are large enough to accommodate standard 3-ring binders
- Side-to-side hanging file bars included for filing letter or legal size documents
- Standard levelling glides ensure drawers are easy to open
- Earth friendly electrostatically applied coating protects the environment and provides a durable finish
- Available in a range of colors, including special paint finishes - see Notes for details



Core removable cam locks are standard



Levelling glides keep the file case true ensuring easy open drawers



Full depth shelves for legal documents

DESIGN AND CONSTRUCTION FEATURES OF 1900P, 9300, 9300P, 9700 FILES

- **THE LETTER "P" IN THE MODEL NUMBER DESIGNATES FULL PULL MODELS.** All other models have recessed center pulls. 9700 Series has satin aluminum pulls.
- An earth friendly electrostatically applied coating protects the environment and provides a durable finish.
- Internal steel corner gussets increasing strength and rigidity.
- Case construction combines spot and mig welding for greater durability. Top cap stiffener included for added strength.
- Standard locks have removable cores for keying alike or later modification in your office. *Master keys and core keys are available; please contact your Global customer service representative.*
- **STANDARD LOCK BARS ARE ON BOTH SIDES OF CABINET PROVIDING INCREASED SECURITY.**
- Positive interlocking system is integrated into each suspension allowing only one drawer to be opened at a time.
- Full extension ball bearing suspensions with built-in feature to prevent drawer bounce back and creepage.
- "B" OPENINGS (with receding doors) will accommodate letter, legal and A4 hanging folders, plus STANDARD THREE RING BINDERS.
- "B" OPENINGS (with fixed drawer fronts) will accommodate letter, legal and A4 hanging folders, plus EDP SUSPENDED DATA BINDERS.
- "L" OPENINGS (with receding doors or fixed drawer fronts) will accommodate letter, legal or A4 hanging file folders.
- 12.25" Opening on 1900P Series
- Receding doors slide easily into cabinet.
- Pull-out shelves have a rolled front edge. Fixed shelves (custom order only) have a flat front edge for easier material retrieval.
- **Interior drawer parts are painted grey using recycled powder.** All accessories are grey.
- Side-to-side hanging file bars are included in standard configurations and are fully set up reducing installation time. These can be positioned for letter, legal or A4 materials.
- Four adjustable leveling glides are easily accessible from inside the cabinet to assist in quick and proper installation.
- **Level 2 Certified**
- Lifetime Warranty. (See Terms and Conditions)
- Counterweights must be specified on lateral files with pull out drawers, unless worksurface supporting, ganged together or anchored to the floor or wall.
*Counterweights are standard on 2, 3 and 4 high 1900P Models

DESIGN AND CONSTRUCTION FEATURES OF 1200P, 9100, 9100P, BLOCKS FILES

- **THE LETTER "P" IN THE MODEL NUMBER DESIGNATES FULL PULL MODELS.** 9100 Series has recessed center pulls.
- An earth friendly electrostatically applied coating protects the environment and provides a durable finish.
- **TOP CAP HAS SEAMLESS FRONT COVERS** plus steel corner gussets improve appearance while increasing strength and rigidity.
- Case construction combines spot and mig welding for greater durability. Top cap stiffener included for added strength.
- Standard locks have removable cores for keying alike or later modification in your office. Master keys and core keys are available; please contact your Global customer service representative.
- **STANDARD LOCK BARS ARE ON BOTH SIDES OF CABINET PROVIDING INCREASED SECURITY.**
- Positive interlocking system is integrated into each suspension allowing only one drawer to be opened at a time.
- Full extension ball bearing suspension with built-in feature to prevent drawer bounce back and creepage.
- "B" OPENINGS (with receding doors) will accommodate letter, legal and A4 hanging folders, plus STANDARD THREE RING BINDERS.
- "B" OPENINGS (with fixed drawer fronts) will accommodate letter, legal and A4 hanging folders, plus EDP SUSPENDED DATA BINDERS.
- "L" OPENINGS (with receding doors or fixed drawer fronts) will accommodate letter, legal or A4 hanging file folders.
- 12" Opening on 1200 Series
- **9100P, 1200P and Blocks DRAWER FRONTS HAVE A WELDED REINFORCEMENT CHANNEL FOR ADDITIONAL STRENGTH.**
- Pull-out shelves have a rolled front edge. Fixed shelves (custom order only) have a flat front edge for easier material retrieval.
- **Interior drawer parts are painted grey using recycled powder.** All accessories are grey.
- Side-to-side hanging file bars are included in standard configurations and are fully set up reducing installation time. These can be positioned for letter, legal or "A4" materials.
- Four adjustable leveling glides are easily accessible from inside the cabinet to assist in quick and proper installation.
- **Level 2 Certified**
- Lifetime Warranty. (See Terms and Conditions)
- Counterweights must be specified on lateral files with pull out drawers, unless worksurface supporting, ganged together or anchored to the floor or wall.

F LATERAL FILES - NOTES

LATERAL FILE SERIES	1900	9300	9300P	9700	1200	9100	9100P	BLOCKS
CONSTRUCTION								
Top Stiffener Bar	•	•	•	•	•	•	•	•
Welded corner gussets for increased strength	•	•	•	•	•	•	•	•
Ganging drill points	4	4	4	4	8	8	8	
Central Locking system with core removable cam locks included	•	•	•	•	•	•	•	•
Electronic Lock option					•			•
Levelling glides (accessible from inside cabinet)	•	•	•	•	•	•	•	•
Counterweights (recommended for 2, 3 & 4 drawers)	Included on 2, 3 & 4 drawers	optional	optional	optional	optional	optional	optional	Included on Lower Blocks
Lifetime Warranty (see terms & conditions)	•	•	•	•	•	•	•	•
DRAWERS / SHELVES								
Drawer interlocking system	•	•	•	•	•	•	•	•
3-stage anti-bounceback suspension	•	•	•	•	•	•	•	•
Side to side file bars, pre-installed (for letter & legal)	•	•	•	•	•	•	•	•
Front to back file bars	optional	optional	optional	optional	optional	optional	optional	optional
Fixed front drawers	available	available	available	available	available	available	available	available
Receding door, roll-out shelves	available	available	available	available	available	available	available	available
Receding doors, fixed shelves		available	available	available	available	available	available	available
Slotted, pull-out shelves with rolled edge	•	•	•	•	•	•	•	•
Plate Dividers - full height drawers	optional	optional	optional	optional	optional	optional	optional	optional
Plate Dividers - half height drawers					optional	optional	optional	
Posting Shelf (5 high only, except 1200 series: 4, 5, 6 high) Not available on an all "B" opening cabinet		optional	optional	optional	*optional on 4, 5 or 6 high	optional	optional	
Integrated Center Pull		•				•		
Integrated Full Pull	•		•		•		•	•
Softouch Hytre™ Handles					optional			
Slimline Satin Aluminum Handles				•				
Integrated Label Holder		•	•		•	•	•	•
Recommended compatible pedestal	1900		G Series	9700	G Series		G Series	G Series
DRAWER HEIGHTS								
Standard Drawer Heights B = Big drawer L = Little drawer	12 ¼"	B - 13 5/16" L - 11 3/16"	B - 13 5/16" L - 11 3/16"	B - 13 5/16" L - 11 3/16"	12"	B - 13 5/16" L - 11 3/16"	B - 13 5/16" L - 11 3/16"	12"
Half Height Drawers					optional	optional	optional	
Ring Binder Storage (available in 5th opening)		•	•	•	optional	•	•	available w/ middle Block
SIZES / DIMENSIONS								
Depth	19 ¼"	18"	18"	18"	18"	18"	18"	18"
Widths	30, 36, 42	30, 36, 42	30, 36, 42	30, 36, 42	30, 36, 42	30, 36, 42	30, 36, 42	36"
Height - 2 drawer	27 5/32"	27 1/8"	27 1/8"	27 1/8"	28 1/2"	27 1/8"	27 1/8"	
Height - 3 drawer	39 17/32"	40 1/2"	40 1/2"	40 1/2"	40 1/2"	40 1/2"	40 1/2"	varies
Height - 4 drawer	51 29/32"	54"	54"	54"	54"	54"	54"	varies
Height - 5 drawer	66 13/32"	65 1/4"	65 1/4"	65 1/4"	65 7/8"	65 1/4"	65 1/4"	varies
Height - 6 drawer					77 7/8"			varies

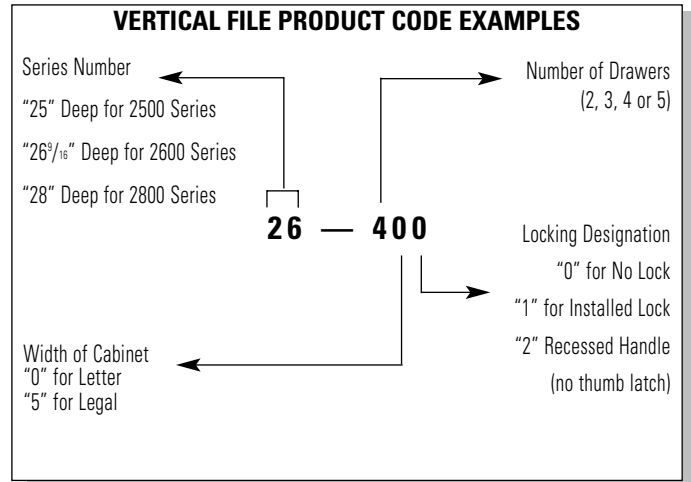
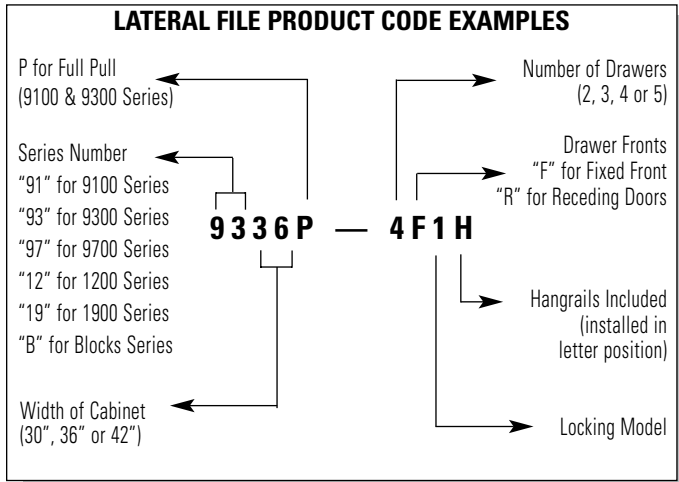

IMPORTANT ORDERING INFORMATION

- Hanging File Bars (accessory model - HBF) are included with standard product. When ordering custom drawer configurations Hanging File Bars (HBF) must be ordered for each drawer.
- Factory installed COUNTER WEIGHT BALANCE (accessory model - CWB) is recommended for use in 30", 36" & 42" wide 2, 3, 4 & 5 drawer free standing lateral files.
- The following page describes the accessories needed to optimize various filing configurations.

STANDARD PAINT FINISHES

BLK BLACK	BGR BUSINESS GREY	CGR CHARCOAL	DPT DESERT PUTTY	GRY GREY
LGR LIGHT GREY	NEV NEVADA	SGR STORM GREY	TSA TAHITI SAND	

SPECIAL PAINT FINISHES

- All special colors must use ONE uniform color per series (example: 9300 series laterals). Quantities of 1 to 10 add 10%; 11 or more are NO UPCHARGE.
- Mica and Metallic finishes add 10% upcharge.
- Special white finishes add 10% upcharge.
- ALL NONSTANDARD FINISHES MUST BE APPROVED BY GLOBAL BEFORE ANY ORDER WILL BE ACCEPTED. LONGER LEAD TIMES WILL APPLY.
- Thumb latches and handles limited to colors listed above. You must choose closest or contrasting color at the time of order.

TWO TONE OPTION

- **File casing will be one color, drawers and door fronts will be painted a second color.**
- **Available on Metal Lateral Files, Storage Cabinets and Pedestals.**
- **Choose any of Global's 9 standard finishes, 13 premium finishes and 5 textured finishes**
- **Vertical files are NOT available with this option at this time.**
- **10% upcharge applies**

F LATERAL FILES - OPTIONS & CAPACITY RESOURCE GUIDE

INTERIOR CLEAR OPENING WIDTH DIMENSIONS & FILING CAPACITIES

30" WIDE CABINETS

Fixed Front Drawer	26 9/16"
Receding Door and Roll-out Shelf	26 9/16"
Receding Door and Fixed Shelf	26 3/16"
1200 Series	26 9/16"

36" WIDE CABINETS



Fixed Front Drawer	32 9/16"
Receding Door and Roll-out Shelf	32 9/16"
Receding Door and Fixed Shelf	32 3/16"
1200 Series	32 9/16"

42" WIDE CABINETS

Fixed Front Drawer	38 9/16"
Receding Door and Roll-out Shelf	38 9/16"
Receding Door and Fixed Shelf	38 3/16"
1200 Series	38 9/16"

Lateral files afford flexibility in filing configuration. Choose the best option based on materials to be filed and convenience for the user.

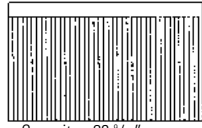
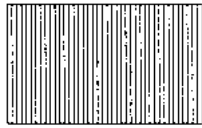
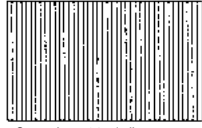
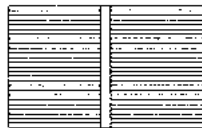
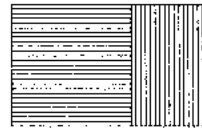
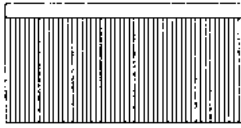
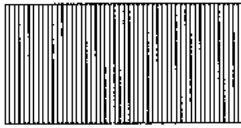
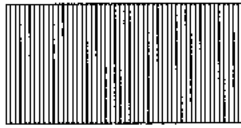
Additional hanging folder supports or conversion kits may be necessary to achieve your desired drawer configuration.

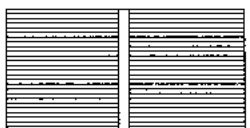
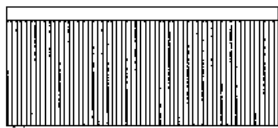
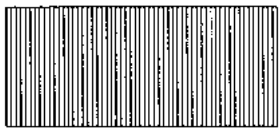
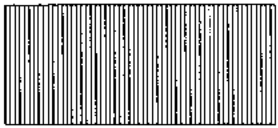
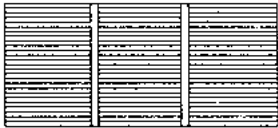
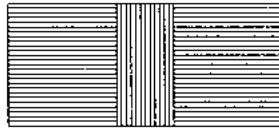
	Letter "B" & "L" Openings, Fixed Front Drawers & Roll-out Shelves	Legal "B" & "L" Openings, Fixed Front Drawers & Roll-out Shelves	EDP "B" Opening, Fixed Front Drawers
30" Wide Units Side-To-Side Side-to-side file bars are included in standard product.	 <p>Capacity - 26 9/16"</p>	 <p>Capacity - 26 9/16"</p>	 <p>Capacity - 26 9/16" Need ONE pair of EDPs.</p>
	30" Wide Units Front-To-Back Not Standard See chart to order the correct number of FBBs per drawer.	 <p>Cap. - 31 1/2". Need ONE pair of FBB. <i>Not recommended for "L" Openings with Receding doors and Roll-out shelves.</i></p>	 <p>Cap. - 26 5/8". Need ONE pair of FBB <i>Not recommended for "L" Openings with Receding doors and Roll-out shelves.</i></p>
36" Wide Units Side-To-Side Side-to-side file bars are included in standard product.	 <p>Capacity - 32 9/16"</p>	 <p>Capacity - 32 9/16"</p>	 <p>Capacity - 32 9/16" Need ONE pair EDPs.</p>
	36" Wide Units Front-To-Back Not Standard See chart to order the correct number of FBBs per drawer.	 <p>Cap. - 31 1/2". Need ONE pair of FBB. <i>Not recommended for "L" Openings with Receding doors and Roll-out shelves.</i></p>	 <p>Cap. - 31 1/2". Need ONE pair of FBB. <i>Not recommended for "L" Openings with Receding doors and Roll-out shelves.</i></p>
42" Wide Units Side-To-Side Side-to-side file bars are included in standard product.	 <p>Capacity - 38 9/16"</p>	 <p>Capacity - 38 9/16"</p>	 <p>Capacity - 38 9/16" Need ONE pair EDPs.</p>
	42" Wide Units Front-To-Back Not Standard See chart to order the correct number of FBBs per drawer.	 <p>Cap. - 37 1/4". Need TWO pair of FBB <i>Not recommended for "L" Openings with Receding doors and Roll-out shelves.</i></p>	 <p>Cap. - 40 1/16". Need ONE pair of FBB. <i>Not recommended for "L" Openings with Receding doors and Roll-out shelves.</i></p>

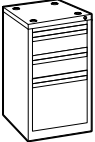
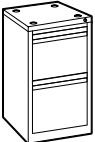
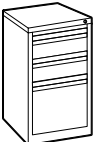
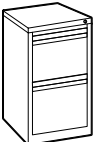
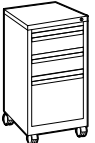
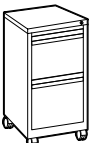
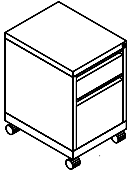
1900P SERIES PEDESTALS		MODEL#	DIMENSIONS	FREIGHT CLASS	WT/LBS.	CUBIC FT.	LIST PRICE
		D x W x H					
	Box, Box & File Pedestal	19WP19BBF	18.62 x 15 x 27.62	125	45	6	\$310
		19WP23BBF	22.62 x 15 x 27.62	125	50	7.20	\$320
		19WP29BBF	28.62 x 15 x 27.62	150	50	8.90	\$360
		Two box and one file drawer pedestal. To be used under worksurface. Locking. 27 5/8" high. Angled full pull.					
	File/File Pedestal	19WP19FF	18.62 x 15 x 27.62	125	42	6	\$310
		19WP23FF	22.62 x 15 x 27.62	125	47	7.20	\$320
		19WP29FF	28.62 x 15 x 27.62	125	55	8.90	\$360
		Two file drawer pedestal. To be used under worksurface. Locking. 27 5/8" high. Angled full pull.					
	Box, Box & File Pedestal - finished top	19FP19BBF	18.62 x 15 x 27.62	100	53	6	\$320
		19FP23BBF	22.62 x 15 x 27.62	100	59	7.20	\$330
		19FP29BBF	29.62 x 15 x 27.62	125	71	8.90	\$370
		Two box and one file drawer pedestal. Freestanding. Locking. 27 5/8" high. Counterweight is standard. Angled full pull.					
	File/File Pedestal - finished top	19FP19FF	18.62 x 15 x 27.62	100	51	6	\$320
		19FP23FF	22.62 x 15 x 27.62	125	56	7.20	\$330
		19FP29FF	29.62 x 15 x 27.62	125	68	8.90	\$370
		Two file drawer pedestal. Freestanding. Locking. 27 5/8" high. Counterweight is standard. Angled full pull.					
1900P MOBILE PEDESTALS							
	Box, Box & File Pedestal - Mobile	19MP19BBF	18.62 x 15 x 27.85	100	61	4.5	\$395
		19MP23BBF	22.62 x 15 x 27.85	125	67	5.5	\$420
		Two box and one file drawer pedestal. Includes casters already attached. Locking. 27.85" high					
	File/File Pedestal - Mobile	19MP19FF	18.62 x 15 x 27.85	100	59	4.5	\$395
		19MP23FF	22.62 x 15 x 27.85	125	64	5.5	\$420
		Two file drawer pedestal. Includes casters already attached. Locking. 27.85" high					
Hanging Bars and Clips		PEDHFB	--		0.5	1	\$15
		For 1900 series Pedestals.					
	Box/File Pedestal	19MCP19BFNC	18.62 x 15 x 23.125	92.5	54	5	\$400
		19MCP23BFNC	22.62 x 15 x 23.125	100	58	6	\$420
		One box and one file drawer pedestal. Freestanding. Locking. 23 1/8" high. Angled full pull.					

Required Specifications
Metal Finish

Optional Specifications
Cushion (19MCPxxBFNC only)

Accessories
Front to Back File Bars

P G SERIES PEDESTALS

1900 PEDESTAL CUSHIONS

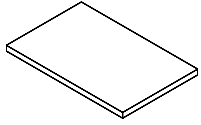

Cushions for 1900 Box/File Pedestal

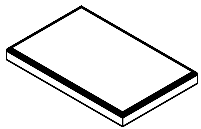

Cushions for 1900 Box/File Pedestal

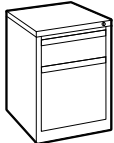

Box & File Pedestal

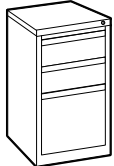

Box, Box & File Pedestal

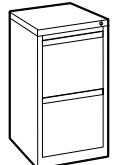

File File Pedestal

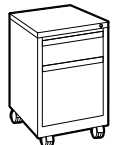

Box & File Mobile Pedestal

MODEL#	DIMENSIONS	FREIGHT CLASS	WT/LBS.	CUBIC FT.	GRADE	LIST PRICE
--------	------------	---------------	---------	-----------	-------	------------

D x W x H

CUSH-15X18-5/8X1	15 x 18.5 x 1	150	4	0.75	3	\$109
					4	\$127
					5	\$141
					6	\$162

CUSH-15X22-5/8X1	15 x 22.5 x 1	150	5	0.90	3	\$123
					4	\$141
					5	\$155
					6	\$176

For models 19MCP19BFNC and 19MCP23BFNC ONLY. 1" thick single stitched cushions. Available in all standard Global seating fabrics. Attached with supplied Velcro fasteners.

- **Cannot be used on standard mobile box/box/file, file/file or box/file pedestals**

CUSH-15X18-5/8X2	15 x 18.5 x 2	125	5	0.75	3	\$121
					4	\$139
					5	\$153
					6	\$174

CUSH-15X22-5/8X2	15 x 22.5 x 2	125	6	0.90	3	\$136
					4	\$160
					5	\$179
					6	\$207

For models 19MCP19BFNC and 19MCP23BFNC ONLY. 2" thick single stitched cushions. Available in all standard Global seating fabrics. Attached with supplied Velcro fasteners.

- **Cannot be used on standard mobile box/box/file, file/file or box/file pedestals**

GWP-19BF	19 x 15 x 21	92.5	50	5		\$362
GWP-23BF	23 x 15 x 21	100	54	6		\$378
GWP-29BF	29 x 15 x 21	100	60	7		\$391

One box and one file drawer pedestal. Freestanding. Locking. 21"H.

GWP-19BBF	19 x 15 x 27.12	92.5	69	6		\$398
GWP-23BBF	23 x 15 x 27.12	92.5	75	7		\$411
GWP-29BBF	29 x 15 x 27.12	100	80	9		\$425

Two box and one file drawer pedestal. Freestanding. Locking. 27.12"H.

GWP-19FF	19 x 15 x 27.12	92.5	69	6		\$398
GWP-23FF	23 x 15 x 27.12	92.5	75	7		\$411
GWP-29FF	29 x 15 x 27.12	100	80	9		\$425

Two file drawer pedestal. Freestanding. Locking. 27.12"H.

GMP-19BF	19 x 15 x 22	70	76	5		\$411
GMP-23BF	23 x 15 x 22	85	80	6		\$425
GMP-29BF	29 x 15 x 22	85	86	7		\$438

One box and one file drawer pedestal. Includes casters already attached. Locking. 22"H.

- **Cannot be used as guest seating**

Required Specifications

Metal Finish

G SERIES PEDESTALS

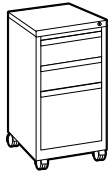

Box, Box & File Pedestal

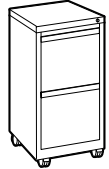

File File Pedestal

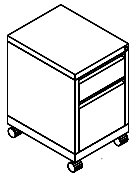

Box & File Pedestal with Cushion

MODEL#	DIMENSIONS D x W x H	FREIGHT CLASS	WT/LBS.	CUBIC FT.	GRADE	LIST PRICE
GMP-19BBF	19 x 15 x 28	70	95	6		\$445
GMP-23BBF	23 x 15 x 28	85	101	7		\$458
GMP-29BBF	29 x 15 x 28	92.5	106	9		\$472

Two box and one file drawer pedestal. Includes casters already attached. Locking. 28"H.

• **Cannot be used as guest seating**

GMP-19FF	19 x 15 x 28	70	95	6		\$445
GMP-23FF	23 x 15 x 28	85	101	7		\$458
GMP-29FF	29 x 15 x 28	92.5	106	9		\$472

Two file drawer pedestal. Includes casters already attached. Locking. 28"H.

• **Cannot be used as guest seating**

93MCP-19BF	19 x 15 x 26.125	70	50	5	3	\$528
					4	\$565
					5	\$597
93MCP-23BF	23 x 15 x 26.125	85	54	6	3	\$542
					4	\$608
					5	\$668

Models without cushion:

93MCP-19BFNC	19 x 15 x 23.875	92.5	60	5.20		\$432
93MCP-23BFNC	23 x 15 x 23.875	92.5	65	6.20		\$456

9300 Series mobile pedestal with 2.25" cushion on top on models 93MCP-19BF and 93MCP-23BF. Includes one box and one file drawer with full pull design. Locking. Fits under any worksurface. Grade 3 seating fabrics are standard.

9700 SERIES FREESTANDING PEDESTALS



Box & File Pedestal



Box, Box & File Pedestal

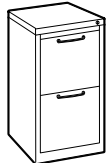

File File Pedestal

97WP-19BF	19 x 15 x 21	92.5	50	4.70		\$389
97WP-23BF	23 x 15 x 21	100	54	5.50		\$407
97WP-29BF	29 x 15 x 21	100	60	6.80		\$500

One box and one file drawer pedestal. **Slimline satin aluminum handles.** Freestanding. Locking. 21" high.

97WP-19BBF	19 x 15 x 27.12	92.5	69	5.90		\$425
97WP-23BBF	23 x 15 x 27.12	92.5	75	7		\$440
97WP-29BBF	29 x 15 x 27.12	100	80	8.70		\$534

Two box and one file drawer pedestal. **Slimline satin aluminum handles.** Freestanding. Locking. 27 1/8" high.

97WP-19FF	19 x 15 x 27.12	92.5	69	5.90		\$425
97WP-23FF	23 x 15 x 27.12	92.5	75	7		\$440
97WP-29FF	23 x 15 x 27.12	100	80	8.70		\$534

Two file drawer pedestal. **Slimline satin aluminum handles.** Freestanding. Locking. 27 1/8" high.

Required Specifications

Metal Finish

P 9700 PEDESTALS

9700 SERIES MOBILE PEDESTALS



Box & File Mobile Pedestal

MODEL#	DIMENSIONS D x W x H	FREIGHT CLASS	WT/LBS.	CUBIC FT.	LIST PRICE
97MP-19BF	19 x 15 x 21.93	70	76	4.80	\$432
97MP-23BF	23 x 15 x 21.93	85	80	5.70	\$448
97MP-29BF	29 x 15 x 21.93	85	93	7	\$542

One box and one file drawer pedestal. **Slimline satin aluminum handles.** Includes casters already attached. Locking. 21.93"H.

- **Cannot be used as guest seating**



Box, Box & File Pedestal

97MP-19BBF	19 x 15 x 27.93	70	95	6.10	\$466
97MP-23BBF	23 x 15 x 27.93	85	101	7.20	\$481
97MP-29BBF	29 x 15 x 27.93	92.5	98	8.90	\$576

Two box and one file drawer pedestal. **Slimline satin aluminum handles.** Includes casters already attached. Locking. 27.93"H.

- **Cannot be used as guest seating**

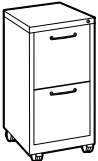

File File Pedestal

97MP-19FF	19 x 15 x 27.93	70	95	6.10	\$466
97MP-23FF	23 x 15 x 27.93	92.5	85	7.20	\$481
97MP-29FF	29 x 15 x 27.93	92.5	106	8.90	\$576

Two file drawer pedestal. **Slimline satin aluminum handles.** Includes casters already attached. Locking.

- **Cannot be used as guest seating**

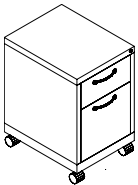

Box, File Pedestal, without Cushion

97MCP-19BFNC	19 x 15 x 23.875	70	60	5.2	\$455
97MCP-23BFNC	23 x 15 x 23.875	70	65	6.2	\$480

Stagecoach with a 9700 Series **mobile pedestal.** Includes one box and one file drawer with slimline aluminum handles. Locking. Fits under any worksurface.

Required Specifications

Metal Finish

1200P SERIES FREESTANDING PEDESTALS

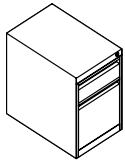

Box/File Pedestal

MODEL#	DIMENSIONS D x W x H	FREIGHT CLASS	WT/LBS.	CUBIC FT.	LIST PRICE
12P18BF	18 x 15 x 21.75	85	57	4.33	\$348
12P19BF	19 x 15 x 21.75	85	58	4.55	\$348
12P23BF	23 x 15 x 21.75	85	66	5.44	\$352
12P24BF	24 x 15 x 21.75	85	68	5.66	\$352
12P29BF	29 x 15 x 21.75	92.5	76	6.77	\$426
12P30BF	30 x 15 x 21.75	92.5	78	6.99	\$426

One box and one file drawer pedestal. **Freestanding. Nominal dimensions.**

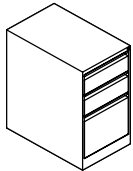

Box/Box/File Pedestal

12P18BBF	18 x 15 x 27.65	85	68	5.43	\$357
12P19BBF	19 x 15 x 27.65	85	70	5.71	\$357
12P23BBF	23 x 15 x 27.65	92.5	74	6.82	\$362
12P24BBF	24 x 15 x 27.65	92.5	76	7.10	\$362
12P29BBF	29 x 15 x 27.65	92.5	88	8.49	\$436
12P30BBF	30 x 15 x 27.65	92.5	92	8.77	\$436

Two box and one file drawer pedestal. **Freestanding/Worksurface Supporting.** Lock mounted on the right hand side. **Nominal dimensions.**

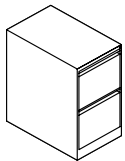

File/File Pedestal

12P18FF	18 x 15 x 27.65	92.5	56	5.43	\$357
12P19FF	19 x 15 x 27.65	92.5	58	5.71	\$357
12P23FF	23 x 15 x 27.65	92.5	70	6.82	\$362
12P24FF	24 x 15 x 27.65	92.5	72	7.10	\$362
12P29FF	29 x 15 x 27.65	100	84	8.49	\$436
12P30FF	30 x 15 x 27.65	92.5	88	8.77	\$436

Two file drawer pedestal. **Freestanding/Worksurface Supporting.** Lock mounted on the right hand side. **Nominal dimensions.**

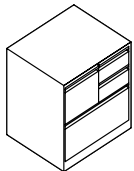

Linear Combo Pedestal

1230PDPL	18 x 30 x 27.75	70	170	10.44	\$1014
1230PDPR	18 x 30 x 27.75	70	170	10.44	\$1014

Box/Box/File and Lateral File drawer. **Nominal dimensions.**

1200 SERIES MOBILE PEDESTALS

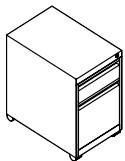

Mobile Box/File Pedestal

12P18BFM	18 x 15 x 22.12	70	74	4.40	\$487
12P19BFM	19 x 15 x 22.12	70	75	4.62	\$487
12P23BFM	23 x 15 x 22.12	85	80	5.53	\$491
12P24BFM	24 x 15 x 22.12	85	82	5.75	\$491
12P29BFM	29 x 15 x 22.12	85	90	6.88	\$565
12P30BFM	30 x 15 x 22.12	85	92	6.99	\$565

One box and one file drawer pedestal. **On Casters.** Lock mounted on the right hand side. Includes factory-installed counterweight balance. Can fit under worksurface. **Nominal dimensions.**

- **Cannot be used as guest seating**

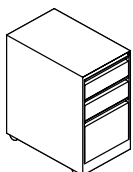

Mobile Box/Box/File Pedestal

12P18BBFM	18 x 15 x 28.5	85	82	5.47	\$496
12P19BBFM	19 x 15 x 28.5	85	84	5.75	\$496
12P23BBFM	23 x 15 x 28.5	85	94	6.87	\$500
12P24BBFM	24 x 15 x 28.5	85	99	7.15	\$500
12P29BBFM	29 x 15 x 28.5	92.5	101	8.55	\$575
12P30BBFM	30 x 15 x 28.5	92.5	106	8.84	\$575

Two box and one file drawer pedestal. **On Casters.** Lock mounted on the right hand side. Includes factory-installed counterweight balance. **Nominal dimensions.**

- **Cannot be used as guest seating**

Required Specifications

Metal Finish

P 1200 / E SERIES PEDESTALS

1200 SERIES MOBILE PEDESTALS

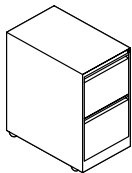

Mobile File/File Pedestal

MODEL#	DIMENSIONS D x W x H	FREIGHT CLASS	WT/LBS.	CUBIC FT.	LIST PRICE
12P18FFM	18 x 15 x 28.5	85	80	5.47	\$496
12P19FFM	19 x 15 x 28.5	85	82	5.75	\$496
12P23FFM	23 x 15 x 28.5	85	90	6.87	\$500
12P24FFM	24 x 15 x 28.5	85	97	7.15	\$500
12P29FFM	29 x 15 x 28.5	92.5	99	8.55	\$575
12P30FFM	30 x 15 x 28.5	92.5	104	8.84	\$575

Two file drawer pedestal. **On casters.** Lock mounted on the right hand side. Includes factory-installed counterweight balance. **Nominal dimensions.**

- **Cannot be used as guest seating**

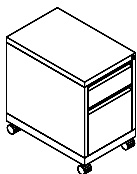

**Mobile Box/File Pedestal
without Cushion**

12P19BFMLC	19 x 15 x 24.5	70	77	5.10	\$528
12P23BFMLC	23 x 15 x 24.5	85	82	6.10	\$533
12P29BFMLC	29 x 15 x 24.5	85	92	7.60	\$607
12P19BFMLKC	19 x 15 x 24.5	70	77	5.10	\$542
12P23BFMLKC	23 x 15 x 24.5	85	82	6.10	\$547
12P29BFMLKC	29 x 15 x 24.5	85	92	7.60	\$621

One box and one file drawer pedestal with **60 mm Casters.** Lock mounted on the right hand side. Includes factory-installed counterweight. **Can accommodate a 1" or 2" cushion** (see page 691). **Nominal dimensions.**

- Specify LKC models for locking casters.

E SERIES FREESTANDING PEDESTALS

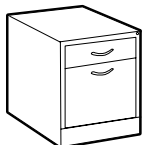

Box/File Pedestal

EWP19BF	19 x 15 x 21	100	50	5.50	\$378
EWP23BF	23 x 15 x 21	100	54	5.90	\$391
EWP29BF	29 x 15 x 21	100	60	6.80	\$404

One box and one file drawer pedestal. **Freestanding.** Soft touch Hytrel pull handles in Black (**BLK**) only. Lock mounted on the right hand side.



Box/Box/File Pedestal

EWP19BBF	19 x 15 x 27.12	92.5	69	5.90	\$411
EWP23BBF	23 x 15 x 27.12	92.5	75	7	\$425
EWP29BBF	29 x 15 x 27.12	100	80	8.70	\$438

Two box and one file drawer pedestal. **Freestanding.** Soft touch Hytrel pull handles in Black (**BLK**) only. Lock mounted on the right hand side

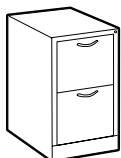

File/File Pedestal

EWP19FF	19 x 15 x 27.12	92.5	69	5.90	\$411
EWP23FF	23 x 15 x 27.12	92.5	75	7	\$425
EWP29FF	29 x 15 x 27.12	100	80	8.70	\$438

Two file drawer pedestal. **Freestanding.** Soft touch Hytrel pull handles in Black (**BLK**) only. Matches the height of two high lateral files. Lock mounted on the right hand side

E SERIES MOBILE PEDESTALS



Mobile Box/File Pedestal

EMP19BF	19 x 15 x 21.93	70	76	4.80	\$413
EMP23BF	23 x 15 x 21.93	85	80	5.70	\$425
EMP29BF	29 x 15 x 21.93	85	86	7.10	\$438

One box and one file drawer pedestal. **On Casters.** Soft touch Hytrel pull handles in Black (**BLK**) only. Lock mounted on the right hand side. Can fit under worksurface.

- **Cannot be used as guest seating**

Required Specifications

Metal Finish

E SERIES MOBILE PEDESTALS



Mobile Box/Box/File Pedestal

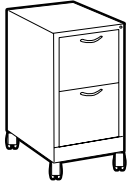

Mobile File/File Pedestal

MODEL#	DIMENSIONS	FREIGHT CLASS	WT/LBS.	CUBIC FT.	LIST PRICE
--------	------------	---------------	---------	-----------	------------

D x W x H

EMP19BBF	19 x 15 x 27.93	70	95	6.10	\$446
EMP23BBF	23 x 15 x 27.93	85	101	7.20	\$459
EMP29BBF	29 x 15 x 27.93	92.5	106	8.90	\$472

Two box and one file drawer. Locking. **On Casters.** Soft touch Hytrel pull handles in Black (**BLK**) only. Lock mounted on the right hand side. Can fit under worksurface.

- **Cannot be used as guest seating**

EMP19FF	19 x 15 x 27.93	70	95	6.08	\$446
EMP23FF	23 x 15 x 27.93	85	101	7.21	\$459
EMP29FF	29 x 15 x 27.93	125	62	8.90	\$472

Two file drawers. Locking. **On Casters.** Soft touch Hytrel pull handles in Black (**BLK**) only. Lock mounted on the right hand side. Can fit under worksurface.

- **Cannot be used as guest seating**

CUSHIONS FOR PEDESTALS

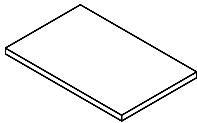

Cushions for Mobile Box/File Pedestals

CUSHION-15X19X1	15 x 19 x 1	150	5	1	1	\$109
					2	\$127
					3	\$141
					4	\$162
CUSHION-15X23X1	15 x 23 x 1	150	5	1	1	\$123
					2	\$141
					3	\$155
					4	\$176
CUSHION-15X29X1	15 x 29 x 1	150	5	1	1	\$163
					2	\$187
					3	\$206
					4	\$234

For seating pedestals. 1" thick single stitched cushions. Available in all standard Global seating fabrics. Attached with supplied Velcro fasteners.

- **Cannot be used on standard mobile box/box/file, file/file or box/file pedestals**

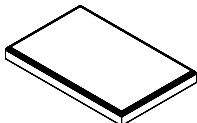

Cushions for Mobile Box/File Pedestals

CUSHION-15X19X2	15 x 19 x 2	150	5	1	1	\$121
					2	\$139
					3	\$153
					4	\$174
CUSHION-15X23X2	15 x 23 x 2	150	5	1	1	\$136
					2	\$154
					3	\$168
					4	\$189
CUSHION-15X29X2	15 x 29 x 2	150	5	1	1	\$180
					2	\$204
					3	\$223
					4	\$251

For seating pedestals. 2" thick single stitched cushions. Cushion features a waterfall edge on the front and back. Available in all standard Global seating fabrics. Attached with supplied Velcro fasteners.

- **Cannot be used on standard mobile box/box/file, file/file or box/file pedestals**

Required Specifications

Metal Finish (Pedestals)
Fabric (Cushion)

L 1900P LATERAL FILES

1900P SERIES MODEL# DIMENSIONS FREIGHT CLASS WT/LBS. CUBIC FT. LIST PRICE

D x W x H

This series not available with binder openings. THE POSITION OF OPENINGS CAN NOT BE MODIFIED FROM THE PICTURE AS SHOWN

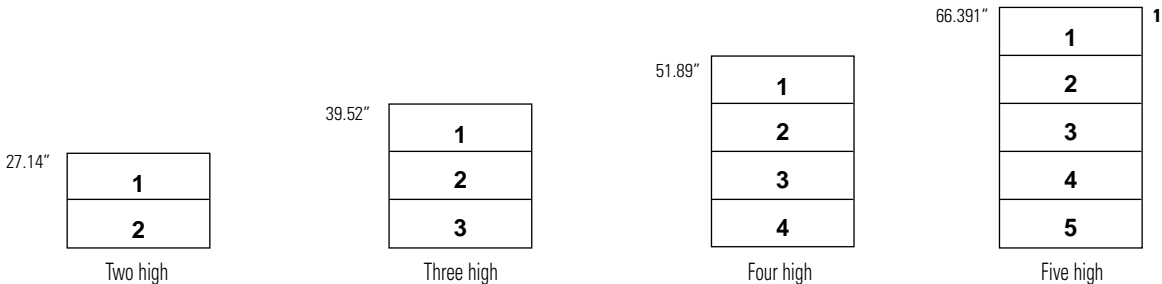

*Five Drawer Model - Top door is standard as receding door.

INTERIOR LATERAL FILE OPENINGS

Drawer - Height 11 1/4" Drawer - Depth 15 3/4" Fixed Shelf - Depth 15 3/16"

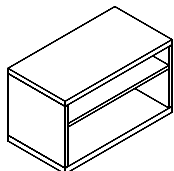

1 1/2 h Storage Cabinet

1930-1XSND	19.25 x 30 x 21.25	150	46.13	9.79	\$325
1936-1XSND	19.25 x 36 x 21.25	150	52.88	11.60	\$375
1942-1XSND	19.25 x 42 x 21.25	150	58.5	13.41	\$425

12" and 6" open shelves.

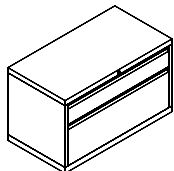

1 1/2 h Storage Cabinet w/File drawer and half height drawer

1930P-1X1FH	19.25 x 30 x 21.25	85	121.5	9.79	\$650
1936P-1X1FH	19.25 x 36 x 21.25	92.5	132	11.60	\$700
1942P-1X1FH	19.25 x 42 x 21.25	92.5	151.5	13.41	\$750

12" fixed front lateral file drawer and 6" half height drawer. Locking.

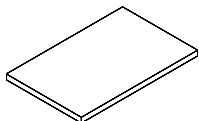

Lateral File Cushion

CUSH19-25X30X1	19.25 x 30 x 1	125	7	1.60	1	\$200
					2	\$226
					3	\$246
					4	\$277
CUSH19-25X36X1	19.25 x 36 x 1	150	7	1.60	1	\$206
					2	\$232
					3	\$252
					4	\$283
CUSH19-25X42X1	19.25 x 42 x 1	250	4	1.60	1	\$214
					2	\$240
					3	\$260
					4	\$291

1" thick single stitched cushions for lateral files. Rectilinear design on all sides. Available in all standard Global seating fabrics. Attached with supplied Velcro fasteners.

Required Specifications
Metal Finish

Optional Specifications
Counterweight

Accessories
Front to Back File Bars
Plate Dividers

1900P SERIES

MODEL#	DIMENSIONS	FREIGHT CLASS	WT/LBS.	CUBIC FT.	LIST PRICE
--------	------------	---------------	---------	-----------	------------

D x W x H

CUSH19-25X30X2	19.25 x 30 x 2	125	8	1.30	1	\$222
					2	\$248
					3	\$268
					4	\$299
CUSH19-25X36X2	19.25 x 36 x 2	150	7	1.60	1	\$228
					2	\$254
					3	\$274
					4	\$305
CUSH19-25X42X2	19.25 x 42 x 2	150	7	1.60	1	\$235
					2	\$261
					3	\$281
					4	\$312

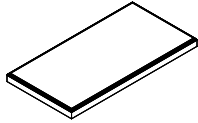

Lateral File Cushion

2" thick single stitched cushions for lateral files. Waterfall edge on front and back. Available in all standard Global seating fabrics. Attached with supplied Velcro fasteners.



2 Drawer Lateral File

1930P-2F12	19.25 x 30 x 27.35	100	115	13	\$545
1936P-2F12	19.25 x 36 x 27.35	100	134	15	\$595
1942P-2F12	19.25 x 42 x 27.35	125	143	18	\$645

Counterweight is standard. Two fixed front drawers. Side-to-side hanging file bars included.

- Drawers are 12.25" high.
- **File cannot be used to store standard three ring binders.**



Mobile Lateral File Kit

19-MLK	20 x 30-36 x 3.875	125	6	1	\$190
--------	--------------------	-----	---	---	-------

Attaches beneath 1900 series 2-drawer lateral file to create a mobile lateral file. ***FOR USE UNDER 1930P-2F12 AND 1936P-2F12 LATERAL FILE ONLY***. Black paint only.

- **Cannot be used on 1942P-2F12 lateral files or any other 18"d lateral files**



3 Drawer Lateral File

1930P-3F12	19.25 x 30 x 39.52	125	145	18	\$700
1936P-3F12	19.25 x 36 x 39.52	125	161	22	\$750
1942P-3F12	19.25 x 42 x 39.52	125	168	25	\$800

- **File cannot be used to store standard three ring binders.**
- Drawers are 12.25" high.

Counterweight is standard. Three fixed front drawers. Side-to-side hanging file bars included.

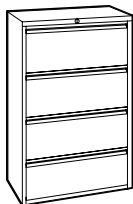

4 Drawer Lateral File

1930P-4F12	19.25 x 30 x 51.89	125	169	24	\$895
1936P-4F12	19.25 x 36 x 51.89	125	189	28	\$945
1942P-4F12	19.25 x 42 x 51.89	150	202	32	\$995

- **File cannot be used to store standard three ring binders.**
- Drawers are 12.25" high.

Counterweight is standard. Four fixed front drawers. Side-to-side hanging file bars included.

- Posting shelf option NOT available

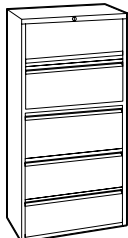

5 Drawer Lateral File

1930P-5F12	19.25 x 30 x 66.39	125	198	29	\$1070
1936P-5F12	19.25 x 36 x 66.39	150	218	35	\$1120
1942P-5F12	19.25 x 42 x 66.39	150	242	40	\$1150

- **File cannot be used to store standard three ring binders.**
- Drawers are 12.25" high.

Four fixed front drawers plus top drawer with receding door and roll-out shelf. Side-to-side hanging file bars included.

- Posting shelf option NOT available

Required Specifications

Metal Finish
Fabric (cushion)

Accessories

Front to Back File Bars
Plate Dividers

L 1900P/9300/9300P LATERAL FILES

1900P SERIES LATERAL FILE TOPS

MODEL# DIMENSIONS FREIGHT CLASS WT/LBS. CUBIC FT. LIST PRICE

D x W x H

LATERAL FILE TOP NOTES:

Available finishes:

ACJ	Absolute Acajou	CSJ	Constellation Java	SOG	Storm Grey	WHC	White Chocolate
ASN	Asian Night	DES	Dark Espresso	TFW	Tiger Fruitwood	WGY	Willow Grey
AWC	Avant Cherry	GRY	Grey	TMA	Tiger Mahogany	WCR	Winter Cherry
AWH	Avant Honey	HGT	Hayden Grey	TMP	Tiger Maple		
BLK	Black	QTM	Quartered Mahogany	TWL	Tiger Walnut		
BRC	Brushed Cobalt	SKC	Shaker Cherry	WHT	White		

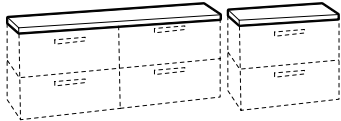

30" wide	T1930	19.25 x 30 x 1.13	60	19	.63	\$192
36" wide	T1936	19.25 x 36 x 1.13	60	23	.73	\$234
42" wide	T1942	19.25 x 42 x 1.13	60	27	.83	\$274
60" wide	T1960	19.25 x 60 x 1.13	60	40	1.15	\$377
72" wide	T1972	19.25 x 72 x 1.13	60	48	1.35	\$451
84" wide	T1984	19.25 x 84 x 1.13	60	56	1.55	\$525
90" wide	T1990	19.25 x 90 x 1.13	60	52	1	\$590
96" wide	T1996	19.25 x 96 x 1.13	60	54.50	1.10	\$590
108" wide	T19108	19.25 x 108 x 1.13	60	59	1.20	\$663

Lateral File Tops

1 1/8" thick laminate tops for placement over metal files. Coordinates with 1900 Series Files. Finish options are listed above.

- Contact Global for pricing on special size tops.

9300 / 9300P OPENING LOCATION SPECIFICATIONS

Available in Fixed Drawer or Receding Door with Roll-out Shelf. THE POSITION OF "B" & "L" OPENINGS CAN NOT BE MODIFIED FROM THE PICTURE AS SHOWN

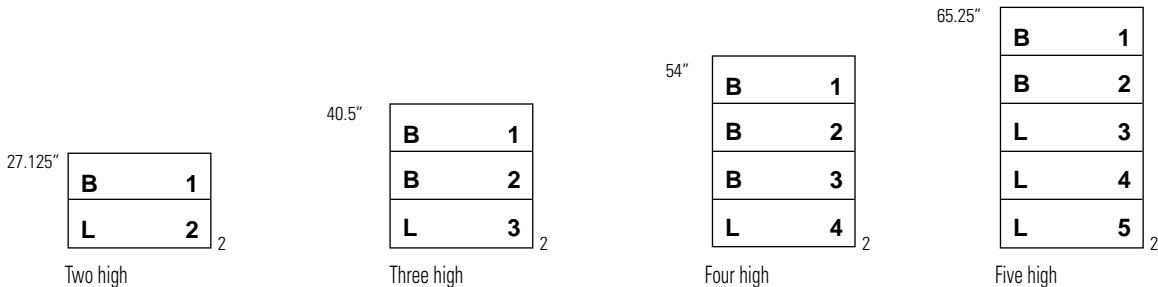

¹Five Drawer Model - Top door is standard as receding door.

²Bottom is standard as a fixed front drawer.

9300 SERIES FILE OPENINGS

"B" Opening (Fixed Front)

13 5/16" High drawer to accommodate letter, legal "A4" metric size documents, and EDP "2" point suspended binders.

"B" Opening (Receding Door)

13 5/16" High door with either Fixed or Roll-out Shelf to accommodate letter, legal "A4" metric size documents and standard three-ring binders.

"L" Opening (Fixed Front or Receding Door)

11 3/16" High Fixed Front Drawer or Receding Door with either Fixed or Roll-out Shelf to accommodate letter, legal and "A4" metric size documents

INTERIOR CLEAR OPENING HEIGHT & DEPTH DIMENSIONS

"B" Opening

Fixed Front Drawer	13"
Receding Door and Roll-out Shelf	12 1/8"
Receding Door and Fixed Shelf	11 3/4"
Fixed Shelf and no Receding Door	12 3/4"

"L" Opening

Fixed Front Drawer	10 7/8"
Receding Door and Roll-out Shelf	10"
Receding Door and Fixed Shelf	9 5/8"
Fixed Shelf and no Receding Door	10 5/8"

"B" & "L" Openings

Drawer – Depth	15 3/4"
Roll-out Shelf – Depth	15 3/4"
Fixed Shelf – Depth	15 3/4"

Required Specifications

Metal Finish
Laminate Finish (Tops)

Optional Specifications

Counterweight

Accessories

Front to Back File Bars
Plate Dividers

9300P SERIES - FIXED DRAWERS

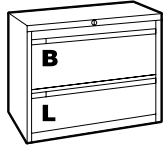

2 Drawer Lateral File

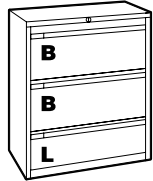

3 Drawer Lateral File

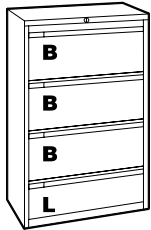

4 Drawer Lateral File

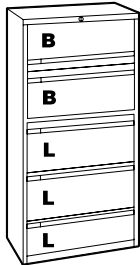

5 Drawer Lateral File



Posting Shelf

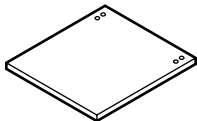

Counter Weight Balance

MODEL#	DIMENSIONS	FREIGHT CLASS	WT/LBS.	CUBIC FT.	LIST PRICE
--------	------------	---------------	---------	-----------	------------

D x W x H

9330P-2F1H	18 x 30 x 27.12	100	103	12	\$555
9336P-2F1H	18 x 36 x 27.12	125	110	14	\$604
9342P-2F1H	18 x 42 x 27.12	125	118	17	\$682

Two fixed front drawers. Side-to-side hanging file bars included.

9330P-3F1H	18 x 30 x 40.5	100	138	17	\$725
9336P-3F1H	18 x 36 x 40.5	125	156	21	\$803
9342P-3F1H	18 x 42 x 40.5	125	174	24	\$890

Three fixed front drawers. Side-to-side hanging file bars included.

9330P-4F1H	18 x 30 x 54	125	175	23	\$916
9336P-4F1H	18 x 36 x 54	125	197	27	\$1009
9342P-4F1H	18 x 42 x 54	125	220	31	\$1151

Four fixed front drawers. Side-to-side hanging file bars included.

9330P-5F1H	18 x 30 x 65.25	125	215	27	\$1158
9336P-5F1H	18 x 36 x 65.25	125	245	32	\$1271
9342P-5F1H	18 x 42 x 65.25	125	275	37	\$1433

Four fixed front drawers plus top drawer with receding door and roll-out shelf. Side-to-side hanging file bars included.

93PS30	--	--	--	--	\$57
93PS36	--	--	--	--	\$63
93PS42	--	--	--	--	\$70

Available in 5 drawer only between 2nd and 3rd opening. Must be factory installed.

Counter Weight for 2 Drawer	--	**	--	\$149
Counter Weight for 3 Drawer	--	**	--	\$129
Counter Weight for 4 Drawer	--	**	--	\$109
Counter Weight for 5 Drawer	--	**	--	\$89

Recommended for use in 30", 36" & 42" wide 2, 3, 4 & 5 drawer free standing laterals. Must be factory installed.

** Weight varies depending on which file cabinet the counter weight is used on.

Required Specifications

Metal Finish

Optional Specifications

Counterweight

Accessories

Front to Back File Bars
Plate Dividers

L 9300P LATERAL FILES

9300P SERIES - RECEDING DRAWERS

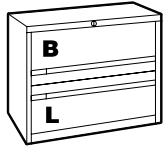

2 Drawer Lateral File

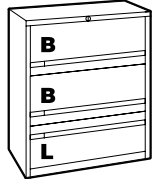

3 Drawer Lateral File

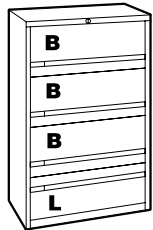

4 Drawer Lateral File

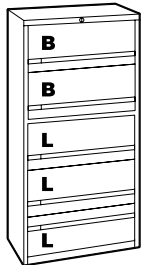

5 Drawer Lateral File

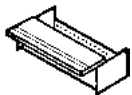

Converter

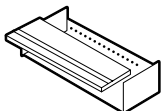

Receding Door & Roll-Out Shelf Converter

MODEL#	DIMENSIONS D x W x H	FREIGHT CLASS	WT/LBS.	CUBIC FT.	LIST PRICE
9330P-2R1H	18 x 30 x 27.12	100	103	12	\$632
9336P-2R1H	18 x 36 x 27.12	125	110	14	\$688
9342P-2R1H	18 x 42 x 27.12	125	118	17	\$761

One receding door with roll-out shelf. Bottom drawer fixed front. Side-to-side hanging file bars included.

9330P-3R1H	18 x 30 x 40.5	100	138	17	\$819
9336P-3R1H	18 x 36 x 40.5	125	156	21	\$906
9342P-3R1H	18 x 42 x 40.5	125	174	24	\$1007

Two receding doors with roll-out shelves. Bottom drawer fixed front. Side-to-side hanging file bars included.

9330P-4R1H	18 x 30 x 54	125	175	23	\$1078
9336P-4R1H	18 x 36 x 54	125	197	27	\$1173
9342P-4R1H	18 x 42 x 54	125	220	31	\$1333

Three receding doors with roll-out shelves. Bottom drawer fixed front. Side-to-side hanging file bars included.

9330P-5R1H	18 x 30 x 65.25	125	215	27	\$1324
9336P-5R1H	18 x 36 x 65.25	125	245	32	\$1468
9342P-5R1H	18 x 42 x 65.25	125	275	37	\$1627

Four receding doors with roll-out shelves. Bottom drawer fixed front. Side-to-side hanging file bars included.

FSC30	30" w	--	--	--	N/C
FSC36	36" w	--	--	--	N/C
FSC42	42" w	--	--	--	N/C

Converts top drawer on 5 drawer model to fixed slotted shelf with a receding door.

RRC30	30" w	--	--	--	\$51
RRC36	36" w	--	--	--	\$51
RRC42	42" w	--	--	--	\$51

Applies to receding door file cabinets only. Bottom drawer only. Must be factory installed. **Add \$51.00 to List Price**

• Specials available. Call for pricing.

Required Specifications
Metal Finish

Optional Specifications
Counterweight

Accessories
Front to Back File Bars
Plate Dividers

9300 SERIES - FIXED DRAWERS

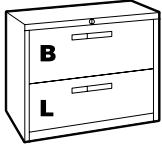

2 Drawer Lateral File

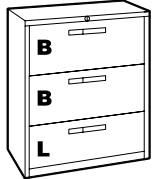

3 Drawer Lateral File

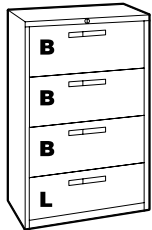

4 Drawer Lateral File

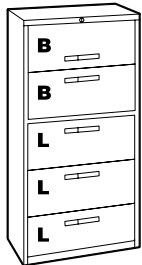

5 Drawer Lateral File



Posting Shelf

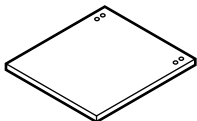

Counter Weight Balance

MODEL#	DIMENSIONS	FREIGHT CLASS	WT/LBS.	CUBIC FT.	LIST PRICE
--------	------------	---------------	---------	-----------	------------

D x W x H

9330-2F1H	18 x 30 x 27.12	100	103	12	\$555
9336-2F1H	18 x 36 x 27.12	125	110	14	\$604
9342-2F1H	18 x 42 x 27.12	125	118	17	\$682

Two fixed front drawers. Side-to-side hanging file bars included.

9330-3F1H	18 x 30 x 40.5	100	138	17	\$725
9336-3F1H	18 x 36 x 40.5	125	156	21	\$803
9342-3F1H	18 x 42 x 40.5	125	174	24	\$890

Three fixed front drawers. Side-to-side hanging file bars included.

9330-4F1H	18 x 30 x 54	125	175	23	\$916
9336-4F1H	18 x 36 x 54	125	197	27	\$1009
9342-4F1H	18 x 42 x 54	125	220	31	\$1151

Four fixed front drawers. Side-to-side hanging file bars included.

9330-5F1H	18 x 30 x 65.25	125	215	27	\$1158
9336-5F1H	18 x 36 x 65.25	125	245	32	\$1271
9342-5F1H	18 x 42 x 65.25	125	275	37	\$1433

Four fixed front drawers plus top drawer with receding door and roll-out shelf. Side-to-side hanging file bars included.

93PS30	--	--	--	--	\$57
93PS36	--	--	--	--	\$63
93PS42	--	--	--	--	\$70

Available in 5 drawer only between 2nd and 3rd opening. Must be factory installed.

Counter Weight for 2 Drawer	--	**	--	\$149
Counter Weight for 3 Drawer	--	**	--	\$129
Counter Weight for 4 Drawer	--	**	--	\$109
Counter Weight for 5 Drawer	--	**	--	\$89

Recommended for use in 30", 36" & 42" wide 2, 3, 4 & 5 drawer free standing laterals. Must be factory installed.

** Weight varies depending on which file cabinet the counter weight is used on.

Required Specifications

Metal Finish

Optional Specifications

Counterweight

Accessories

Front to Back File Bars
Plate Dividers

L 9300 LATERAL FILES

9300 SERIES - RECEDING DRAWERS

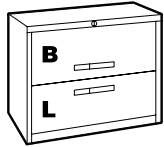

2 Drawer Lateral File

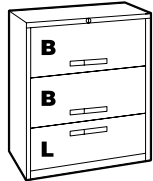

3 Drawer Lateral File

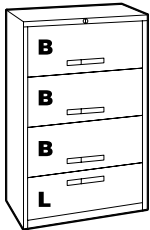

4 Drawer Lateral File

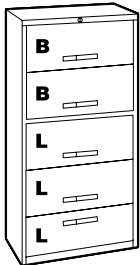

5 Drawer Lateral File

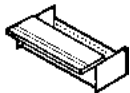

Converter

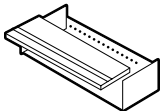

Receding Door & Roll-Out Shelf Converter

MODEL#	DIMENSIONS D x W x H	FREIGHT CLASS	WT/LBS.	CUBIC FT.	LIST PRICE
9330-2R1H	18 x 30 x 27.12	100	103	12	\$632
9336-2R1H	18 x 36 x 27.12	125	110	14	\$688
9342-2R1H	18 x 42 x 27.12	125	118	17	\$761

One receding door with roll-out shelf. Bottom drawer fixed front. Side-to-side hanging file bars included.

9330-3R1H	18 x 30 x 40.5	100	138	17	\$819
9336-3R1H	18 x 36 x 40.5	125	156	21	\$906
9342-3R1H	18 x 42 x 40.5	125	174	24	\$1007

Two receding doors with roll-out shelves. Bottom drawer fixed front. Side-to-side hanging file bars included.

9330-4R1H	18 x 30 x 54	125	175	23	\$1078
9336-4R1H	18 x 36 x 54	125	197	27	\$1173
9342-4R1H	18 x 42 x 54	125	220	31	\$1333

Three receding doors with roll-out shelves. Bottom drawer fixed front. Side-to-side hanging file bars included.

9330-5R1H	18 x 30 x 65.25	125	215	27	\$1391
9336-5R1H	18 x 36 x 65.25	125	245	32	\$1468
9342-5R1H	18 x 42 x 65.25	125	275	37	\$1627

Four receding doors with roll-out shelves. Bottom drawer fixed front. Side-to-side hanging file bars included.

FSC30	30" w	--	--	--	N/C
FSC36	36" w	--	--	--	N/C
FSC42	42" w	--	--	--	N/C

Converts top drawer on 5 drawer model to fixed slotted shelf with a receding door.

RRC30	30" w	--	--	--	\$51
RRC36	36" w	--	--	--	\$51
RRC42	42" w	--	--	--	\$51

Applies to receding door file cabinets only. Bottom drawer only. Must be factory installed. **Add \$51.00 to List Price**

- Specials available. Call for pricing.

Required Specifications

Metal Finish

Optional Specifications

Counterweight

Accessories

Front to Back File Bars
Plate Dividers

9700 SERIES OPENING LOCATION SPECIFICATIONS	MODEL#	DIMENSIONS D x W x H	FREIGHT CLASS	WT/LBS.	CUBIC FT.	LIST PRICE
---	--------	-------------------------	---------------	---------	-----------	------------

THE POSITION OF "B" & "L" OPENINGS CAN NOT BE MODIFIED FROM THE PICTURE AS SHOWN

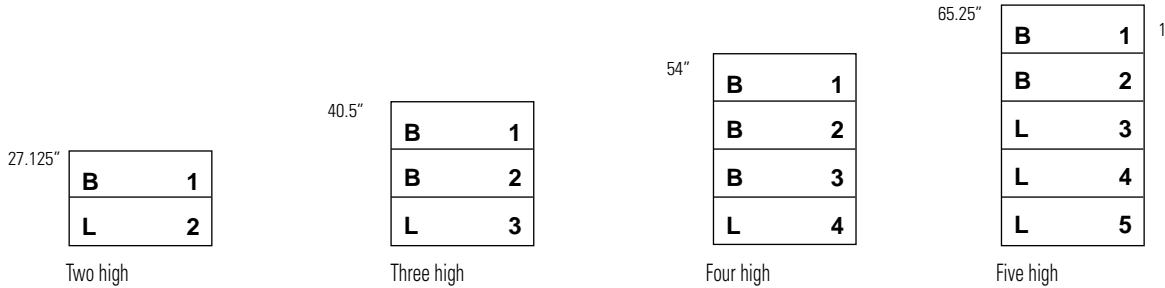

¹Five Drawer Model - Top door is standard as receding door.

9700 SERIES FILE OPENINGS

"B" Opening (Fixed Front)

13 5/16" High drawer to accommodate letter, legal "A4" metric size documents, and EDP "2" point suspended binders.

"B" Opening (Receding Door)

13 5/16" High door with either Fixed or Roll-out Shelf to accommodate letter, legal "A4" metric size documents and standard three-ring binders.

"L" Opening (Fixed Front or Receding Door)

11 3/16" High Fixed Front Drawer or Receding Door with either Fixed or Roll-out Shelf to accommodate letter, legal and "A4" metric size documents

INTERIOR CLEAR OPENING HEIGHT & DEPTH DIMENSIONS

"B" Opening

Fixed Front Drawer	13"
Receding Door and Roll-out Shelf	12 1/8"
Receding Door and Fixed Shelf	11 3/4"
Fixed Shelf and no Receding Door	12 3/4"

"L" Opening

Fixed Front Drawer	10 7/8"
Receding Door and Roll-out Shelf	10"
Receding Door and Fixed Shelf	9 5/8"
Fixed Shelf and no Receding Door	10 5/8"

"B" & "L" Openings

Drawer – Depth	15 3/4"
Roll-out Shelf – Depth	15 3/4"
Fixed Shelf – Depth	15 3/4"

9700 SERIES - FIXED DRAWERS

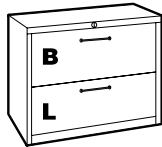

2 Drawer Lateral File

9730-2F1H	18 x 30 x 27.12	100	103	12	\$629
9736-2F1H	18 x 36 x 27.12	125	110	14	\$685
9742-2F1H	18 x 42 x 27.12	125	118	17	\$774

Two fixed front drawers. Slimline satin aluminum handles. Side-to-side hanging file bars included.

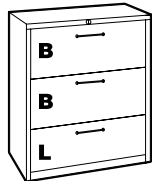

3 Drawer Lateral File

9730-3F1H	18 x 30 x 40.5	100	138	17	\$826
9736-3F1H	18 x 36 x 40.5	125	156	21	\$910
9742-3F1H	18 x 42 x 40.5	125	174	24	\$1008

Three fixed front drawers. Slimline satin aluminum handles. Side-to-side hanging file bars included.

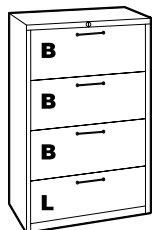

4 Drawer Lateral File

9730-4F1H	18 x 30 x 54	125	175	23	\$1041
9736-4F1H	18 x 36 x 54	125	197	27	\$1146
9742-4F1H	18 x 42 x 54	125	220	31	\$1307

Four fixed front drawers. Slimline satin aluminum handles. Side-to-side hanging file bars included.

Required Specifications

Metal Finish

Optional Specifications

Counterweight

Accessories

Front to Back File Bars
Plate Dividers

L 9700 LATERAL FILES

9700 SERIES - FIXED DRAWERS

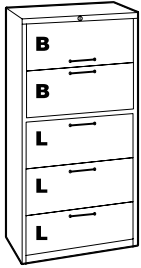

5 Drawer Lateral File



Posting Shelf

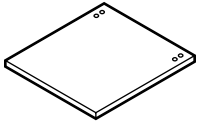

Counter Weight Balance

MODEL#	DIMENSIONS D x W x H	FREIGHT CLASS	WT/LBS.	CUBIC FT.	LIST PRICE
9730-5F1H	18 x 30 x 65.25	125	215	27	\$1375
9736-5F1H	18 x 36 x 65.25	125	245	32	\$1447
9742-5F1H	18 x 42 x 65.25	125	275	37	\$1631

Four fixed front drawers plus top drawer with receding door and roll-out shelf. Slimline satin aluminum handles. Side-to-side hanging file bars included.

93PS30	--	--	--	--	\$57
93PS36	--	--	--	--	\$63
93PS42	--	--	--	--	\$70

Available in 5 drawer only between 2nd and 3rd opening. Must be factory installed.

Counter Weight for 2 Drawer	--	**	--	\$149
Counter Weight for 3 Drawer	--	**	--	\$129
Counter Weight for 4 Drawer	--	**	--	\$109
Counter Weight for 5 Drawer	--	**	--	\$89

Recommended for use in 30", 36" & 42" wide 2, 3, 4 & 5 drawer free standing laterals. Must be factory installed.

** Weight varies depending on which file cabinet the counter weight is used on.

Required Specifications

Metal Finish

Optional Specifications

Counterweight

Accessories

Front to Back File Bars
Plate Dividers

1200 SERIES - HOW TO SPECIFY

MODEL#

DIMENSIONS

FREIGHT CLASS

WT/LBS.

CUBIC FT.

LIST PRICE

TO CREATE MODEL NUMBER 1236P6SRFFFEPC-BLK

Step1	Step 2	Step 3	Step 4	Step 5	Step 6	Step7	Step 8
1236	P	6	Position 1: S Position 2: R Position 3: F Position 4: F Position 5: F Position 6: F	E	P	C	BLK

D x W x H

- Step 1** Choose a Model Number and Width
- Step 2** Choose Pull Option: Full Pull (**P**) or Soft Touch Hytrell™ (**8**)
- Step 3** Select height. **When ordering a 6-high Cabinet, the top drawer is always a Receding Front with a Fixed Shelf**
- Step 4** Select drawer options.
- Step 5** Electronic Lock (**E**), Leave blank for standard lock
- Step 6** Posting Shelf (**P**)
Only available on 4-high, 5-high and 6-high files
- Step 7** Counterweight (**C**), Leave blank for no counterweight
- Step 8** Select Finish

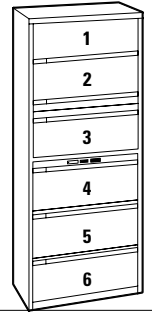

30" CASE

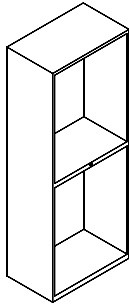

1230P2 (Case 2H)	\$515
1230P3 (Case 3H)	\$639
1230P4 (Case 4H)	\$805
1230P5 (Case 5H)	\$998
1230P6 (Case 6H)	\$1344

30" COMPONENTS:

	F - Fixed Front	\$65
	R - Receding Door	\$110
	S - Fixed Shelf	\$70
	H - Half High	\$225
	B - Binder**	\$120
	P - Posting Shelf	\$140
	E - eLOCK	\$250

36" CASE

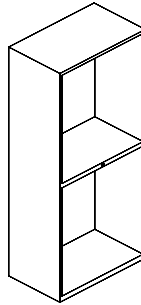

1236P2 (Case 2H)	\$534
1236P3 (Case 3H)	\$688
1236P4 (Case 4H)	\$868
1236P5 (Case 5H)	\$1031
1236P6 (Case 6H)	\$1416

36" COMPONENTS:

	F - Fixed Front	\$75
	R - Receding Door	\$120
	S - Fixed Shelf	\$80
	H - Half High	\$235
	B - Binder**	\$130
	P - Posting Shelf	\$145
	E - eLOCK	\$250

42" CASE

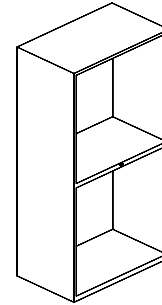

1242P2 (Case 2H)	\$599
1242P3 (Case 3H)	\$759
1242P4 (Case 4H)	\$946
1242P5 (Case 5H)	\$1164
1242P6 (Case 6H)	\$1503

42" COMPONENTS:

	F - Fixed Front	\$95
	R - Receding Door	\$130
	S - Fixed Shelf	\$90
	H - Half High	\$245
	B - Binder**	\$140
	P - Posting Shelf	\$150
	E - eLOCK	\$250

1200 LATERAL FILES

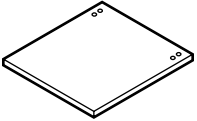
1200 SERIES	MODEL#	DIMENSIONS D x W x H	FREIGHT CLASS	WT/LBS.	CUBIC FT.	LIST PRICE
	Counter Weight for 2 Drawer		--	**	--	\$149
	Counter Weight for 3 Drawer		--	**	--	\$129
	Counter Weight for 4 Drawer		--	**	--	\$109
	Counter Weight for 5 Drawer		--	**	--	\$89
	Counter Weight for 6 Drawer		--	**	--	\$89
	Recommended for use in 30", 36" & 42" wide 2, 3, 4, 5 & 6 drawer free standing laterals. Must be factory installed. ** Weight varies depending on which file cabinet the counter weight is used on.					

Counter Weight Balance

ADDITIONAL NOTES:

Binder Receding Front with Fixed Shelf (B)**

**Available on Position 1 (top) on 2, 3, 4, or 5 high files. Available on positions 1 (top) and 2 (2nd from top) of a 6 high file

Position #1 (for 2, 3, 4, 5 and 6 high models)

Heights when customer orders "B" opening in top position:

1200-2B Top: 28.875", 1200-3B Top: 41.75", 1200-4B Top: 55", 1200-5B Top: 67.063"

Position #2 (for 6 high models ONLY)

Heights when customer orders "B" opening in top position:

1200-6B Top: 79.063", 1200-6BB Top 2: 80.25"

**BINDER RECEDING FRONT WITH FIXED SHELF (B) .

1200 SERIES - 1.5 HIGH

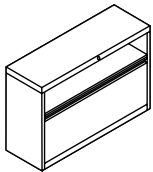

1 1/2 h Storage Cabinet w/File Drawer

1230P1XSF	18 x 30 x 21.75	125	61.37	8.26	\$620
1236P1XSF	18 x 36 x 21.75	125	63.86	9.84	\$635
1242P1XSF	18 x 42 x 21.75	125	78	11.41	\$655

12" Lateral file drawer and 6" open shelf. Locking.

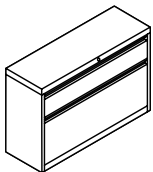

1 1/2 h Storage Cabinet w/File drawer and half height drawer

1230P1XHF	18 x 30 x 21.75	85	103	8.26	\$665
1236P1XHF	18 x 36 x 21.75	92.5	107	9.84	\$680
1242P1XHF	18 x 42 x 21.75	100	112	11.41	\$700

12" fixed front lateral file drawer and 6" half height drawer. Locking.

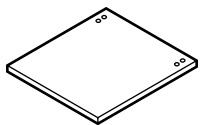

Counterweight for 1.5h Lateral File

CWB30-1X		--	**	--	\$189
CWB36-1X		--	**	--	\$189
CWB42-1X		--	**	--	\$189

Recommended for use in 30", 36" & 42" wide 1.5 high lateral files. Must be factory installed.

** Weight varies depending on which file cabinet the counter weight is used on.

Required Specifications

Metal Finish

Optional Specifications

Counterweight

Accessories

Front to Back File Bars
Plate Dividers

1200 SERIES

MODEL# DIMENSIONS FREIGHT CLASS WT/LBS. CUBIC FT. FAB. GRD. LIST PRICE

D x W x H

CUSHION-18X30X1	18 x 30 x 1	150	7	1.30	1	\$170
					2	\$194
					3	\$213
					4	\$241
CUSHION-18X36X1	18 x 36 x 1	150	7	1.60	1	\$190
					2	\$214
					3	\$233
					4	\$261
CUSHION-18X42X1	18 x 42 x 1	150	4	1.60	1	\$203
					2	\$227
					3	\$246
					4	\$274

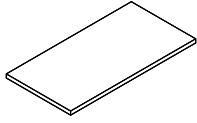

Lateral File Cushion

1" thick single stitched cushions for lateral files. Rectilinear design on all sides. Available in all standard Global seating fabrics. Attached with supplied Velcro fasteners.

CUSHION-18X30X2	18 x 30 x 2	150	5	1	1	\$188
					2	\$212
					3	\$231
					4	\$259
CUSHION-18X36X2	18 x 36 x 2	150	7	1.60	1	\$210
					2	\$234
					3	\$253
					4	\$281
CUSHION-18X42X2	18 x 42 x 2	150	7	1.60	1	\$224
					2	\$248
					3	\$267
					4	\$295

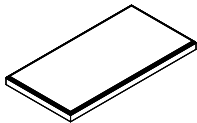

Lateral File Cushion

2" thick single stitched cushions for lateral files. Waterfall edge on front and back. Available in all standard Global seating fabrics. Attached with supplied Velcro fasteners.

1230P2FFWS	18 x 30 x 27.75	92.5	105	10.40	\$645
1236P2FFWS	18 x 36 x 27.75	100	114	12.38	\$684
1242P2FFWS	18 x 42 x 27.75	100	123	14.36	\$789

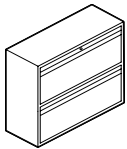

2 Drawer Lateral File - Fixed Front Worksurface supporting

Two fixed front drawers. Side-to-side hanging file bars included.

Required Specifications

Metal Finish (cabinet)
Fabric (cushion)

Optional Specifications

Counterweight

Accessories

Front to Back File Bars
Plate Dividers

L 1200 LATERAL FILES

1200 SERIES - 2 HIGH

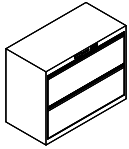

**2 Drawer Lateral File w/E-Lock
Fixed Front**

MODEL#	DIMENSIONS D x W x H	FREIGHT CLASS	WT/LBS.	CUBIC FT.	LIST PRICE
1230P2FFE	18 x 30 x 28.5	100	103	10.69	\$895
1236P2FFE	18 x 36 x 28.5	100	110	12.70	\$934
1242P2FFE	18 x 42 x 28.5	125	117	14.70	\$1039

Two fixed front drawers. Electronic Lock factory installed. Placed in standard key position for each model.

- Side-to-side hanging file bars included.
- All drawers and full shelves are slotted to accept full height dividers
- **File cannot be used to store standard three ring binders.**

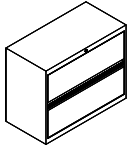

**2 Drawer Lateral File - Receding/Fixed
Worksurface supporting**

1230P2RFWS	18 x 30 x 27.75	100	103	10.69	\$690
1236P2RFWS	18 x 36 x 27.75	100	110	12.70	\$729
1242P2RFWS	18 x 42 x 27.75	125	117	14.70	\$824

One receding door with roll-out shelf. Bottom drawer has fixed front.

- Side-to-side hanging file bars included.
- All drawers and full shelves are slotted to accept full height dividers
- **File cannot be used to store standard three ring binders.**

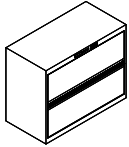

**2 Drawer Lateral File w/E-Lock
Receding Door / Fixed Front**

1230P2RFE	18 x 30 x 28.5	100	103	10.69	\$947
1236P2RFE	18 x 36 x 28.5	100	110	12.70	\$1000
1242P2RFE	18 x 42 x 28.5	125	117	14.70	\$1079

One receding door with roll-out shelf. Bottom drawer has fixed front. Electronic Lock factory installed. Placed in standard key position for each model.

- Side-to-side hanging file bars included.
- All drawers and full shelves are slotted to accept full height dividers
- **File cannot be used to store standard three ring binders.**

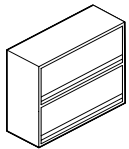

**2 Drawer Lateral File - Receding Doors
Worksurface Supporting**

1230P2SSWS	18 x 30 x 27.75	100	98	10.40	\$655
1236P2SSWS	18 x 36 x 27.75	100	108	12.58	\$694
1242P2SSWS	18 x 42 x 27.75	125	117	14.36	\$779

Two receding door with fixed shelves.

Required Specifications
Metal Finish

Optional Specifications
Counterweight

Accessories
Front to Back File Bars
Plate Dividers

1200 SERIES - 3 HIGH

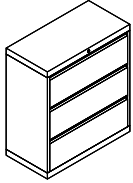

3 Drawer Lateral File - Fixed Front

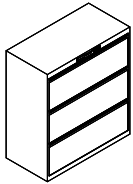

3 Drawer Lateral File w/E-Lock Fixed Front

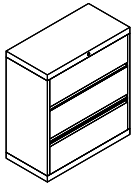

3 Drawer Lateral File 2 Receding Doors / 1 Fixed Front

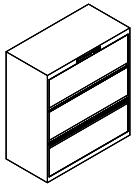

3 Drawer Lateral File w/E-Lock 2 Receding Doors / 1 Fixed Front

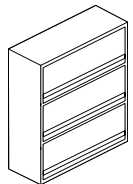

3 Drawer Lateral File - Receding Doors

MODEL#	DIMENSIONS	FREIGHT CLASS	WT/LBS.	CUBIC FT.	LIST PRICE
--------	------------	---------------	---------	-----------	------------

D x W x H

1230P3FFF	18 x 30 x 40.5	100	136	14.93	\$834
1236P3FFF	18 x 36 x 40.5	100	150	17.77	\$913
1242P3FFF	18 x 42 x 40.5	125	164	20.62	\$1044

• **File cannot be used to store standard three ring binders.**

Three fixed front drawers.

- Side-to-side hanging file bars included.
- All drawers and full shelves are slotted to accept full height dividers

1230P3FFFE	18 x 30 x 40.5	100	136	14.95	\$1084
1236P3FFFE	18 x 36 x 40.5	100	150	17.77	\$1163
1242P3FFFE	18 x 42 x 40.5	125	164	20.62	\$1294

• **File cannot be used to store standard three ring binders.**

Three fixed front drawers. Electronic Lock factory installed. Placed in standard key position for each model.

- Side-to-side hanging file bars included.
- All drawers and full shelves are slotted to accept full height dividers

1230P3RRF	18 x 30 x 40.5	100	136	14.95	\$924
1236P3RRF	18 x 36 x 40.5	100	150	17.77	\$1003
1242P3RRF	18 x 42 x 40.5	125	164	20.62	\$1114

• **File cannot be used to store standard three ring binders.**

Two receding doors with roll-out shelves. Bottom drawer has fixed front.

- Side-to-side hanging file bars included.
- All drawers and full shelves are slotted to accept full height dividers

1230P3RRFE	18 x 30 x 40.5	100	136	14.95	\$1163
1236P3RRFE	18 x 36 x 40.5	100	150	17.77	\$1254
1242P3RRFE	18 x 42 x 40.5	125	164	20.62	\$1386

• **File cannot be used to store standard three ring binders.**

Two receding doors with roll-out shelves. Bottom drawer has fixed front. Electronic Lock factory installed. Placed in standard key position for each model.

- Side-to-side hanging file bars included.
- All drawers and full shelves are slotted to accept full height dividers

1230P3SSS	18 x 30 x 40.5	100	130	14.95	\$849
1236P3SSS	18 x 36 x 40.5	125	144	17.77	\$928
1242P3SSS	18 x 42 x 40.5	125	156	20.62	\$1029

• **File cannot be used to store standard three ring binders.**

Three receding doors with fixed shelves.

Required Specifications

Metal Finish

Optional Specifications

Counterweight

Accessories

Front to Back File Bars
Plate Dividers

L 1200 LATERAL FILES

1200 SERIES - 4 HIGH

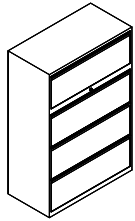

4 Drawer Lateral File - Fixed Front

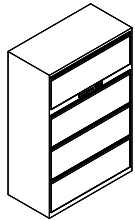

4 Drawer Lateral File w/E-Lock Fixed Front

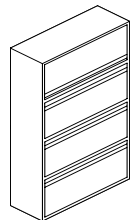

4 Drawer Lateral File, 1 Receding Door / 3 Fixed Front

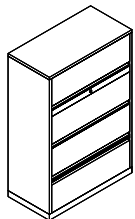

4 Drawer Lateral File 3 Receding Doors / 1 Fixed Front

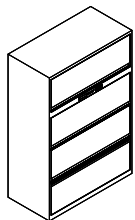

4 Drawer Lateral File w/E-Lock 3 Receding Doors / 1 Fixed Front

MODEL#	DIMENSIONS D x W x H	FREIGHT CLASS	WT/LBS.	CUBIC FT.	LIST PRICE
1230P4FFFF	18 x 30 x 54	100	169	19.73	\$1065
1236P4FFFF	18 x 36 x 54	125	190	23.49	\$1168
1242P4FFFF	18 x 42 x 54	125	211	27.24	\$1326

- File cannot be used to store standard three ring binders.

Four fixed front drawers. Side-to-side hanging file bars included.

- All drawers and full shelves are slotted to accept full height dividers
- Optional Posting Shelf is available between the 1st and 2nd opening.

1230P4FFFFE	18 x 30 x 54	100	169	19.73	\$1315
1236P4FFFFE	18 x 36 x 54	125	190	23.49	\$1418
1242P4FFFFE	18 x 42 x 54	125	211	27.24	\$1576

- File cannot be used to store standard three ring binders.

Four fixed front drawers. Electronic Lock factory installed. Placed in standard key position for each model. Side-to-side hanging file bars included.

- All drawers and full shelves are slotted to accept full height dividers
- *Optional Posting Shelf is available between the 1st and 2nd opening.*

1230P4RFFF	18 x 30 x 54	100	169	19.73	\$1110
1236P4RFFF	18 x 36 x 54	125	190	23.49	\$1213
1242P4RFFF	18 x 42 x 54	125	211	27.24	\$1361

Three fixed front drawers plus top drawer with receding door and roll-out shelf. Side-to-side hanging file bars included.

1230P4RRRF	18 x 30 x 54	100	169	19.73	\$1200
1236P4RRRF	18 x 36 x 54	125	190	23.49	\$1303
1242P4RRRF	18 x 42 x 54	125	211	27.24	\$1431

- File cannot be used to store standard three ring binders.

Three receding doors with roll-out shelves. Bottom drawer has fixed front. Side-to-side hanging file bars included.

- All drawers and full shelves are slotted to accept full height dividers
- *Optional Posting Shelf is available between the 1st and 2nd opening.*

1230P4RRRFE	18 x 30 x 54	100	169	19.73	\$1406
1236P4RRRFE	18 x 36 x 54	125	190	23.49	\$1536
1242P4RRRFE	18 x 42 x 54	125	211	27.24	\$1706

- File cannot be used to store standard three ring binders.

Three receding doors with roll-out shelves. Bottom drawer has fixed front. Electronic Lock factory installed. Placed in standard key position for each model. Side-to-side hanging file bars included.

- All drawers and full shelves are slotted to accept full height dividers
- *Optional Posting Shelf is available between the 1st and 2nd opening.*

Required Specifications
Metal Finish

Optional Specifications
Counterweight

Accessories
Front to Back File Bars
Plate Dividers

1200 SERIES - 4 HIGH

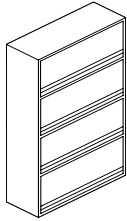

4 Drawer Lateral File - Fixed Front

MODEL#	DIMENSIONS	FREIGHT CLASS	WT/LBS.	CUBIC FT.	LIST PRICE
--------	------------	---------------	---------	-----------	------------

D x W x H

1230P4SSSS	18 x 30 x 54	125	158	19.73	\$1085
1236P4SSSS	18 x 36 x 54	125	179	23.49	\$1188
1242P4SSSS	18 x 42 x 54	125	199	27.24	\$1306

Four receding doors with fixed shelves.

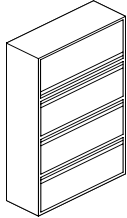

**4 Drawer Lateral File
3 Fixed Front / 1 Binder Drawer**

1230P4BFFF	18 x 30 x 54	100	170	19.73	\$1120
1236P4BFFF	18 x 36 x 54	125	190	23.49	\$1223
1242P4BFFF	18 x 42 x 54	125	211	27.24	\$1371

Three fixed front drawers. Top drawer is binder height.

- Side-to-side hanging file bars included.
- All drawers and full shelves are slotted to accept full height dividers

1200 SERIES - 5 HIGH

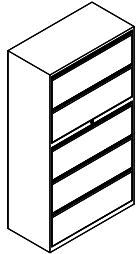

**5 Drawer Lateral File
1 Receding Door / 4 Fixed Front**

1230P5RFFFF	18 x 30 x 65.88	100	202	23.95	\$1411
1236P5RFFFF	18 x 36 x 65.88	125	230	28.51	\$1451
1242P5RFFFF	18 x 42 x 65.88	125	258	33.08	\$1674

- **File cannot be used to store standard three ring binders.**

Four fixed front drawers and one top drawer with receding door and roll-out shelf. Side-to-side hanging file bars included.

- All drawers and full shelves are slotted to accept full height dividers
- *Optional Posting Shelf is available between the 2nd and 3rd opening.*

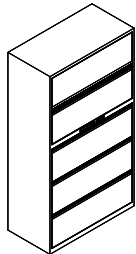

**5 Drawer Lateral File w/E-Lock
1 Receding Door / 4 Fixed Front**

1230P5RFFFFE	18 x 30 x 65.88	100	202	23.95	\$1661
1236P5RFFFFE	18 x 36 x 65.88	125	230	28.51	\$1701
1242P5RFFFFE	18 x 42 x 65.88	125	258	33.08	\$1924

- **File cannot be used to store standard three ring binders.**

Four fixed front drawers and one top drawer with receding door and roll-out shelf. Electronic Lock factory installed. Placed in standard key position for each model. Side-to-side hanging file bars included.

- All drawers and full shelves are slotted to accept full height dividers
- *Optional Posting Shelf is available between the 2nd and 3rd opening.*

Required Specifications

Metal Finish

Optional Specifications

Counterweight

Accessories

Front to Back File Bars
Plate Dividers

L 1200 LATERAL FILES

1200 SERIES - 5 HIGH

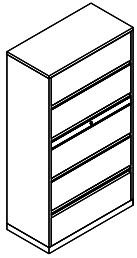

5 Drawer Lateral File
4 Receding Doors / 1 Fixed Front

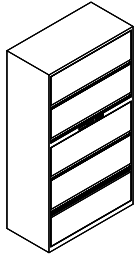

5 Drawer Lateral File w/E-Lock
4 Receding Doors / 1 Fixed Front

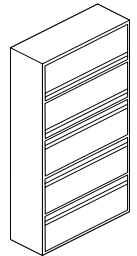

5 Drawer Lateral File
2 Receding Doors / 3 Fixed Front

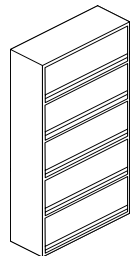

5 Drawer Lateral File
5 Receding Doors

MODEL#	DIMENSIONS D x W x H	FREIGHT CLASS	WT/LBS.	CUBIC FT.	LIST PRICE
1230P5RRRRF	18 x 30 x 65.88	100	202	23.95	\$1503
1236P5RRRRF	18 x 36 x 65.88	125	230	28.51	\$1586
1242P5RRRRF	18 x 42 x 65.88	125	258	33.08	\$1779

- File cannot be used to store standard three ring binders.

Four receding doors with roll-out shelves. Bottom drawer has fixed front. Side-to-side hanging file bars included.

- All drawers and full shelves are slotted to accept full height dividers
- *Optional Posting Shelf is available between the 2nd and 3rd opening.*

1230P5RRRRFE	18 x 30 x 65.88	100	202	23.95	\$1780
1236P5RRRRFE	18 x 36 x 65.88	125	230	28.51	\$1882
1242P5RRRRFE	18 x 42 x 65.88	125	258	33.08	\$2054

- File cannot be used to store standard three ring binders.

Four receding doors with roll-out shelves. Bottom drawer has fixed front. Electronic Lock factory installed. Placed in standard key position for each model. Side-to-side hanging file bars included.

- All drawers and full shelves are slotted to accept full height dividers
- *Optional Posting Shelf is available between the 2nd and 3rd opening.*

1230P5RRFFF	18 x 30 x 65.88	100	203	23.95	\$1413
1236P5RRFFF	18 x 36 x 65.88	125	230	28.51	\$1496
1242P5RRFFF	18 x 42 x 65.88	125	258	33.08	\$1709

Three fixed front drawers and two top drawers with receding doors and roll-out shelves. Side-to-side hanging file bars included.

1230P5SSSSS	18 x 30 x 65.88	125	197	23.95	\$1348
1236P5SSSSS	18 x 36 x 65.88	125	230	28.51	\$1431
1242P5SSSSS	18 x 42 x 65.88	125	243	33.08	\$1614

Five receding doors with fixed shelves. Side-to-side hanging file bars included.

- All drawers and full shelves are slotted to accept full height dividers
- *Optional Posting Shelf is available between the 2nd and 3rd opening.*

Required Specifications
Metal Finish

Optional Specifications
Counterweight

Accessories
Front to Back File Bars
Plate Dividers

1200 SERIES - 5 HIGH

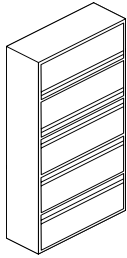

5 Drawer Lateral File - Fixed Front

MODEL#	DIMENSIONS	FREIGHT CLASS	WT/LBS.	CUBIC FT.	LIST PRICE
--------	------------	---------------	---------	-----------	------------

D x W x H

1230P5BRFFF	18 x 30 x 67.06	100	203	24	\$1423
1236P5BRFFF	18 x 36 x 67.06	125	231	29	\$1506
1242P5BRFFF	18 x 42 x 67.06	125	259	34	\$1719

Two receding doors with fixed shelves and 3 fixed drawer fronts.

1200 SERIES - 6 HIGH

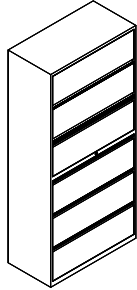

**6 Drawer Lateral File
2 Receding Doors / 4 Fixed Front**

1230P6SRFFFF	18 x 30 x 77.88	125	235	28.22	\$1784
1236P6SRFFFF	18 x 36 x 77.88	125	270	33.59	\$1916
1242P6SRFFFF	18 x 42 x 77.88	125	305	38.97	\$2103

• **File cannot be used to store standard three ring binders.**

- Top drawer is only available with a **fixed** shelf
- 2nd position drawer has a **roll-out**-shelf

Four fixed front drawers and two top drawers with receding doors. Side-to-side hanging file bars included.

- All drawers and full shelves are slotted to accept full height dividers
- *Optional Posting Shelf is available between the 3rd and 4th opening.*

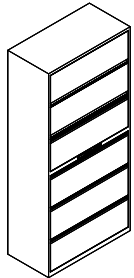

**6 Drawer Lateral File w/E-Lock
2 Receding Doors / 4 Fixed Front**

1230P6SRFFFFE	18 x 30 x 77.88	125	235	28.22	\$2034
1236P6SRFFFFE	18 x 36 x 77.88	125	270	33.59	\$2166
1242P6SRFFFFE	18 x 42 x 77.88	125	305	38.97	\$2353

• **File cannot be used to store standard three ring binders.**

- Top drawer is only available with a **fixed** shelf
- 2nd position drawer has a **roll-out**-shelf

Four fixed front drawers and two top drawers with receding doors. Electronic Lock factory installed. Placed in standard key position for each model. Side-to-side hanging file bars included.

- All drawers and full shelves are slotted to accept full height dividers
- *Optional Posting Shelf is available between the 3rd and 4th opening.*

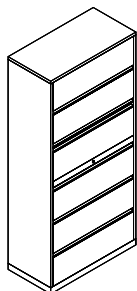

**6 Drawer Lateral File
4 Receding Doors / 2 Fixed Front**

1230P6SRRRRF	18 x 30 x 77.88	125	235	28.22	\$1842
1236P6SRRRRF	18 x 36 x 77.88	125	270	33.59	\$1975
1242P6SRRRRF	18 x 42 x 77.88	125	305	38.97	\$2165

• **File cannot be used to store standard three ring binders.**

- Top drawer is only available with a **fixed** shelf
- 2nd position drawer has a **roll-out**-shelf

Four receding doors with roll-out shelves. Bottom drawer has fixed front. Side-to-side hanging file bars included.

- All drawers and full shelves are slotted to accept full height dividers
- *Optional Posting Shelf is available between the 3rd and 4th opening.*

Required Specifications

Metal Finish

Optional Specifications

Counterweight

Accessories

Front to Back File Bars
Plate Dividers

L 1200 LATERAL FILES

1200 SERIES - 6 HIGH

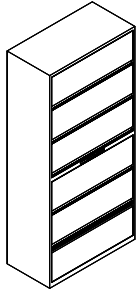

**6 Drawer Lateral File w/E-Lock
4 Receding Doors / 2 Fixed Front**

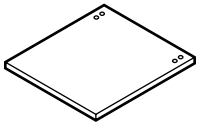

Counter Weight Balance

MODEL#	DIMENSIONS D x W x H	FREIGHT CLASS	WT/LBS.	CUBIC FT.	LIST PRICE
1230P6SRRRRFE	18 x 30 x 77.88	100	235	28.22	\$2092
1236P6SRRRRFE	18 x 36 x 77.88	125	270	33.59	\$2225
1242P6SRRRRFE	18 x 42 x 77.88	125	305	38.97	\$2415

- **File cannot be used to store standard three ring binders.**
- Top drawer is only available with a **fixed** shelf
- 2nd position drawer has a **roll-out**-shelf

Four receding doors with roll-out shelves. Bottom drawer has fixed front. Electronic Lock factory installed. Placed in standard key position for each model. Side-to-side hanging file bars included.

- All drawers and full shelves are slotted to accept full height dividers
- *Optional Posting Shelf is available between the 3rd and 4th opening.*

Counter Weight for 2 Drawer	--	**	--	\$149
Counter Weight for 3 Drawer	--	**	--	\$129
Counter Weight for 4 Drawer	--	**	--	\$109
Counter Weight for 5 Drawer	--	**	--	\$89
Counter Weight for 6 Drawer	--	**	--	\$89

Recommended for use in 30", 36" & 42" wide 2, 3, 4, 5 & 6 drawer free standing laterals. Must be factory installed.

** Weight varies depending on which file cabinet the counter weight is used on.

Required Specifications
Metal Finish

Optional Specifications
Counterweight

Accessories
Front to Back File Bars
Plate Dividers

9100 SERIES OPENING LOCATION SPECIFICATIONS	MODEL#	DIMENSIONS D x W x H	FREIGHT CLASS	WT/LBS.	CUBIC FT.	LIST PRICE
---	--------	-------------------------	---------------	---------	-----------	------------

Available in Fixed Drawer or Receding Door with Roll-out Shelf. **THE POSITION OF "B" & "L" OPENINGS CAN NOT BE MODIFIED FROM THE PICTURE AS SHOWN**

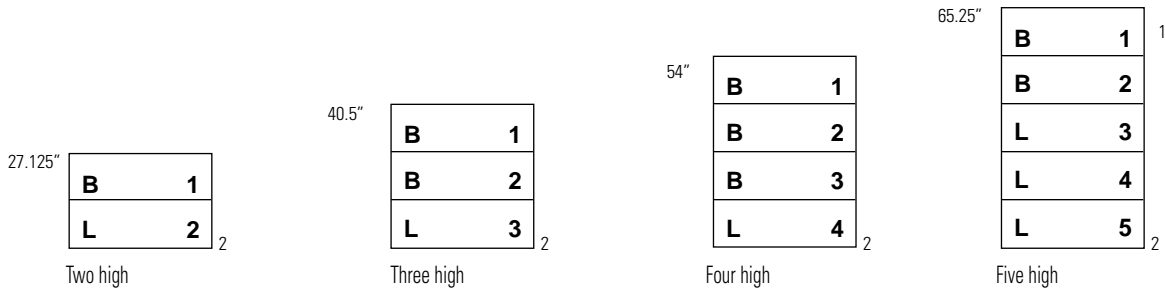

¹Five Drawer Model - Top door is standard as receding door.
²Bottom is standard as a fixed front drawer.

9100 SERIES FILE OPENINGS

"B" Opening (Fixed Front)

13 5/16" High drawer to accommodate letter, legal "A4" metric size documents, and EDP "2" point suspended binders.

"B" Opening (Receding Door)

13 5/16" High door with either Fixed or Roll-out Shelf to accommodate letter, legal "A4" metric size documents and standard three-ring binders.

"L" Opening (Fixed Front or Receding Door)

11 3/16" High Fixed Front Drawer or Receding Door with either Fixed or Roll-out Shelf to accommodate letter, legal and "A4" metric size documents

INTERIOR CLEAR OPENING HEIGHT & DEPTH DIMENSIONS

"B" Opening

Fixed Front Drawer	13"
Receding Door and Roll-out Shelf	12 1/8"
Receding Door and Fixed Shelf	11 3/4"
Fixed Shelf and no Receding Door	12 3/4"

"L" Opening

Fixed Front Drawer	10 7/8"
Receding Door and Roll-out Shelf	10"
Receding Door and Fixed Shelf	9 5/8"
Fixed Shelf and no Receding Door	10 5/8"

"B" & "L" Openings

Drawer – Depth	15 3/4"
Roll-out Shelf – Depth	15 3/4"
Fixed Shelf – Depth	15 3/4"

9100P SERIES - FIXED DRAWERS

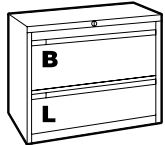

2 Drawer Lateral File

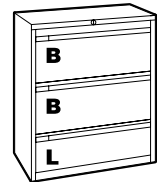

3 Drawer Lateral File

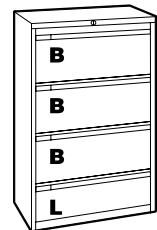

4 Drawer Lateral File

9130P-2F1H	18 x 30 x 27.12	92.5	108	10	\$724
9136P-2F1H	18 x 36 x 27.12	100	115	12	\$769
9142P-2F1H	18 x 42 x 27.12	100	123	14	\$887

Two fixed front drawers. Side-to-side hanging file bars included.

9130P-3F1H	18 x 30 x 40.5	100	146	15	\$938
9136P-3F1H	18 x 36 x 40.5	100	164	18	\$1027
9142P-3F1H	18 x 42 x 40.5	100	182	21	\$1174

Three fixed front drawers. Side-to-side hanging file bars included.

9130P-4F1H	18 x 30 x 54	100	185	20	\$1197
9136P-4F1H	18 x 36 x 54	100	208	24	\$1314
9142P-4F1H	18 x 42 x 54	100	231	28	\$1492

Four fixed front drawers. Side-to-side hanging file bars included.

Required Specifications
Metal Finish

Optional Specifications
Counterweight

Accessories
Front to Back File Bars
Plate Dividers

L 9100P LATERAL FILES

9100P SERIES - FIXED DRAWERS

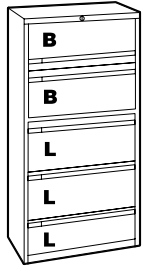

5 Drawer Lateral File

MODEL#	DIMENSIONS D x W x H	FREIGHT CLASS	WT/LBS.	CUBIC FT.	LIST PRICE
9130P-5F1H	18 x 30 x 65.25	100	228	25	\$1587
9136P-5F1H	18 x 36 x 65.25	100	258	29	\$1632
9142P-5F1H	18 x 42 x 65.25	100	288	34	\$1883

Four fixed front drawers plus top drawer with receding door and roll-out shelf. Side-to-side hanging file bars included.



Posting Shelf

91PS30	--	--	--	--	\$57
91PS36	--	--	--	--	\$63
91PS42	--	--	--	--	\$70

Available in 5 drawer only between 2nd and 3rd opening. Must be factory installed.

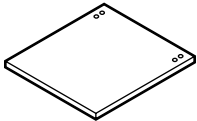

Counter Weight Balance

Counter Weight for 2 Drawer	--	**	--	\$149
Counter Weight for 3 Drawer	--	**	--	\$129
Counter Weight for 4 Drawer	--	**	--	\$109
Counter Weight for 5 Drawer	--	**	--	\$89

Recommended for use in 30", 36" & 42" wide 2, 3, 4 & 5 drawer free standing laterals. Must be factory installed.
** Weight varies depending on which file cabinet the counter weight is used on.

9100P SERIES - RECEDING DRAWERS

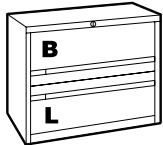

2 Drawer Lateral File

9130P-2R1H	18 x 30 x 27.12	92.5	108	10	\$784
9136P-2R1H	18 x 36 x 27.12	100	115	12	\$843
9142P-2R1H	18 x 42 x 27.12	100	123	14	\$932

One receding door with roll-out shelf. Bottom drawer fixed front. Side-to-side hanging file bars included.

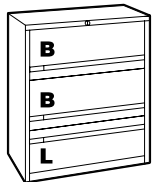

3 Drawer Lateral File

9130P-3R1H	18 x 30 x 40.5	100	146	15	\$1027
9136P-3R1H	18 x 36 x 40.5	100	164	18	\$1130
9142P-3R1H	18 x 42 x 40.5	100	182	21	\$1278

Two receding doors with roll-out shelves. Bottom drawer fixed front. Side-to-side hanging file bars included.

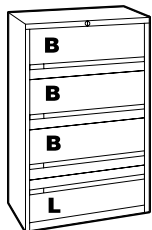

4 Drawer Lateral File

9130P-4R1H	18 x 30 x 54	100	185	20	\$1300
9136P-4R1H	18 x 36 x 54	100	208	24	\$1446
9142P-4R1H	18 x 42 x 54	100	231	28	\$1638

Three receding doors with roll-out shelves. Bottom drawer fixed front. Side-to-side hanging file bars included.

Required Specifications
Metal Finish

Optional Specifications
Counterweight

Accessories
Front to Back File Bars
Plate Dividers

9100P SERIES - RECEDING DRAWERS

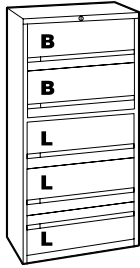

5 Drawer Lateral File

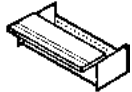

Converter

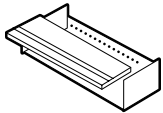

Receding Door & Roll-Out Shelf Converter

MODEL#	DIMENSIONS	FREIGHT CLASS	WT/LBS.	CUBIC FT.	LIST PRICE
--------	------------	---------------	---------	-----------	------------

D x W x H

9130P-5R1H	18 x 30 x 65.25	100	228	25	\$1721
9136P-5R1H	18 x 36 x 65.25	100	258	29	\$1837
9142P-5R1H	18 x 42 x 65.25	100	288	34	\$2030

Four receding doors with roll-out shelves. Bottom drawer fixed front. Side-to-side hanging file bars included.

FSC30	30" w	--	--	--	N/C
FSC36	36" w	--	--	--	N/C
FSC42	42" w	--	--	--	N/C

Converts top drawer on 5 drawer model to fixed slotted shelf with a receding door.

RRC30	30" w	--	--	--	\$51
RRC36	36" w	--	--	--	\$51
RRC42	42" w	--	--	--	\$51

Applies to receding door file cabinets only. Bottom drawer only. Must be factory installed. **Add \$51.00 to List Price**

- Specials available. Call for pricing.

9100P SERIES - FIXED DRAWERS, ALL BINDER OPENINGS

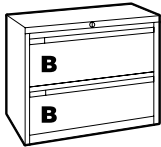

2 Drawer Lateral File

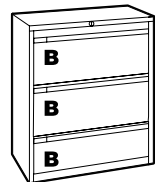

3 Drawer Lateral File

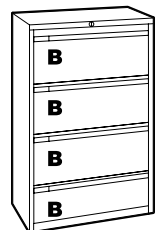

4 Drawer Lateral File

9130P-2FBH	18 x 30 x 29.25	92.5	112	11	\$974
9136P-2FBH	18 x 36 x 29.25	100	120	13	\$1019
9142P-2FBH	18 x 42 x 29.25	100	128	15	\$1060

Two fixed front drawers. Side-to-side hanging file bars included. **All drawers feature "B" Binder openings to accommodate binders.** 29 1/4" high.

9130P-3FBH	18 x 30 x 42.62	100	151	16	\$1239
9136P-3FBH	18 x 36 x 42.62	100	169	19	\$1283
9142P-3FBH	18 x 42 x 42.62	100	187	22	\$1371

Three fixed front drawers. Side-to-side hanging file bars included. **All drawers feature "B" Binder openings to accommodate binders.** 42 5/8" high.

9130P-4FBH	18 x 30 x 56.12	100	190	21	\$1504
9136P-4FBH	18 x 36 x 56.12	100	213	25	\$1562
9142P-4FBH	18 x 42 x 56.12	100	236	29	\$1636

Four fixed front drawers. Side-to-side hanging file bars included. **All drawers feature "B" Binder openings to accommodate binders.** 56 1/8" high.

Required Specifications

Metal Finish

Optional Specifications

Counterweight

Accessories

Front to Back File Bars
Plate Dividers

L 9100P LATERAL FILES

9100P SERIES - ALL BINDER OPENINGS

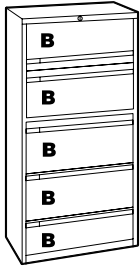

5 Drawer Lateral File

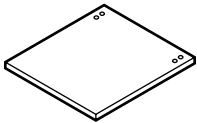

Counter Weight Balance

MODEL#	DIMENSIONS D x W x H	FREIGHT CLASS	WT/LBS.	CUBIC FT.	LIST PRICE
9130P-5FBH	18 x 30 x 69.5	100	233	27	\$1887
9136P-5FBH	18 x 36 x 69.5	100	263	31	\$1946
9142P-5FBH	18 x 42 x 69.5	100	293	36	\$2033

Four fixed front drawers plus top drawer with receding door and roll-out shelf. Side-to-side hanging file bars included. **All drawers feature "B" Binder openings to accommodate binders.** 69 1/2" high.

- Posting shelf is not available on this model.

Counter Weight for 2 Drawer	--	**	--	\$149
Counter Weight for 3 Drawer	--	**	--	\$129
Counter Weight for 4 Drawer	--	**	--	\$109
Counter Weight for 5 Drawer	--	**	--	\$89

Recommended for use in 30", 36" & 42" wide 2, 3, 4 & 5 drawer free standing laterals. Must be factory installed.

** Weight varies depending on which file cabinet the counter weight is used on.

9100P SERIES - RECEDING DRAWERS, ALL BINDER OPENINGS

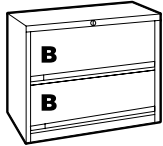

2 Drawer Lateral File

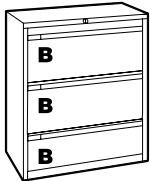

3 Drawer Lateral File

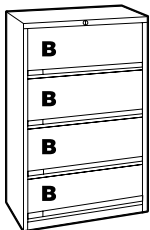

4 Drawer Lateral File

9130P-2RBH	18 x 30 x 29.25	100	106	11	\$1019
9136P-2RBH	18 x 36 x 29.25	100	113	13	\$1060
9142P-2RBH	18 x 42 x 29.25	100	121	15	\$1120

Two receding doors with roll-out shelves. Side-to-side hanging file bars included. **All drawers feature "B" Binder openings to accommodate binders.** 29 1/4" high.

9130P-3RBH	18 x 30 x 42.62	100	144	16	\$1312
9136P-3RBH	18 x 36 x 42.62	100	162	19	\$1357
9142P-3RBH	18 x 42 x 42.62	100	190	22	\$1430

Three receding doors with roll-out shelves. Side-to-side hanging file bars included. **All drawers feature "B" Binder openings to accommodate binders.** 42 5/8" high.

9130P-4RBH	18 x 30 x 56.12	100	183	21	\$1605
9136P-4RBH	18 x 36 x 56.12	100	206	25	\$1666
9142P-4RBH	18 x 42 x 56.12	125	229	29	\$1753

Four receding doors with roll-out shelves. Side-to-side hanging file bars included. **All drawers feature "B" Binder openings to accommodate binders.** 56 1/8" high.

Required Specifications
Metal Finish

Optional Specifications
Counterweight

Accessories
Front to Back File Bars
Plate Dividers

9100P SERIES - RECEDING, ALL BINDER OPENINGS

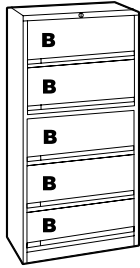

5 Drawer Lateral File

MODEL#	DIMENSIONS	FREIGHT CLASS	WT/LBS.	CUBIC FT.	LIST PRICE
--------	------------	---------------	---------	-----------	------------

D x W x H

9130P-5RBH	18 x 30 x 69.5	100	224	27	\$1974
9136P-5RBH	18 x 36 x 69.5	100	254	31	\$2048
9142P-5RBH	18 x 42 x 69.5	125	284	36	\$2152

Five receding doors with roll-out shelves. Side-to-side hanging file bars included. **All drawers feature "B" Binder openings to accommodate binders.** 69½"H.

- Posting shelf is not available on this model.

9100P SERIES - END TAB FILES



2 Drawer END TAB Lateral File

9130P-2ET	18 x 30 x 29	100	72.80	9.08	\$669
9136P-2ET	18 x 36 x 29	125	78	11	\$678
9142P-2ET	18 x 42 x 29	125	83.80	12.70	\$690

Two receding drawer fronts. All drawers feature a fixed shelf with receding front.

- Includes 3 ETPD (end tab plate dividers) per opening
- To be used for END TAB filing and SHELF STORAGE.
- Interior shelf height is **10.792"**. **File cannot be used to store standard three ring binders.**



3 Drawer END TAB Lateral File

9130P-3ET	18 x 30 x 42	125	98.90	13.20	\$851
9136P-3ET	18 x 36 x 42	125	106	16	\$869
9142P-3ET	18 x 42 x 42	125	113.80	18.40	\$889

Three receding drawer fronts. All drawers feature a fixed shelf with receding front.

- Includes 3 ETPD (end tab plate dividers) per opening
- To be used for END TAB filing and SHELF STORAGE.
- Interior shelf height is **10.792"**. **File cannot be used to store standard three ring binders.**

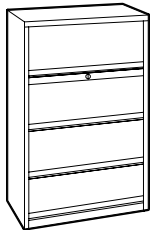

4 Drawer END TAB Lateral File

9130P-4ET	18 x 30 x 56.25	125	140.10	17.60	\$1071
9136P-4ET	18 x 36 x 56.25	125	151	21	\$1095
9142P-4ET	18 x 42 x 56.25	125	161.10	24.70	\$1121

Four receding drawer fronts. All drawers feature a fixed shelf with receding front.

- Includes 3 ETPD (end tab plate dividers) per opening
- To be used for END TAB filing and SHELF STORAGE.
- Interior shelf height is **10.792"**. **File cannot be used to store standard three ring binders.**

Required Specifications

Metal Finish

Optional Specifications

Counterweight

Accessories

Front to Back File Bars
Plate Dividers

L 9100P LATERAL FILES

9100P SERIES - END TAB FILES

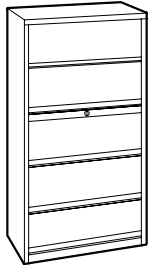

5 Drawer END TAB Lateral File

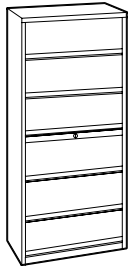

6 Drawer END TAB Lateral File



Posting Shelf



End Tab Files Accessory



End Tab Plate Dividers

MODEL#	DIMENSIONS	FREIGHT CLASS	WT/LBS.	CUBIC FT.	LIST PRICE
	D x W x H				
9130P-5ET	18 x 30 x 69.25	125	166.70	21.70	\$1225
9136P-5ET	18 x 36 x 69.25	125	179	26	\$1256
9142P-5ET	18 x 42 x 69.25	125	191.80	30.30	\$1286

Five receding drawer fronts. All drawers feature a fixed shelf with receding front.

- Includes 3 ETPD (end tab plate dividers) per opening
- To be used for END TAB filing and SHELF STORAGE.
- Interior shelf height is **10.792"**. **File cannot be used to store standard three ring binders.**

9130P-6ET	18 x 30 x 82.19	125	195.10	25.70	\$1378
9136P-6ET	18 x 36 x 82.19	125	210	31	\$1415
9142P-6ET	18 x 42 x 82.19	125	224.50	36	\$1452

Six receding drawer fronts. All drawers feature a fixed shelf with receding front.

- Includes 3 ETPD (end tab plate dividers) per opening
- To be used for END TAB filing and SHELF STORAGE.
- Interior shelf height is **10.792"**. **File cannot be used to store standard three ring binders.**

91PSET30 (posting shelf)--	--	--	--	--	\$117
91PSET36	--	--	--	--	\$117
91PSET42	--	--	--	--	\$135

Available on 4, 5 and 6 drawer high models. Must be factory installed.

ETFB30 (end tab files accessory)--	--	--	--	--	\$13
ETFB36	--	--	--	--	\$13
ETFB42	--	--	--	--	\$14

One each per drawer. Grey. Attaches to End Tab plate dividers. Prevents letter size folders from shifting to the back of the filing shelf.

ETPD	--	100	4	.10	\$30
------	----	-----	---	-----	-------------

Three per package. Grey.

Required Specifications
Metal Finish

Optional Specifications
Counterweight

Accessories
Front to Back File Bars
Plate Dividers

9100P SERIES - FIXED DRAWERS, SECURITY FILES

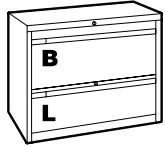

2 Drawer Lateral File

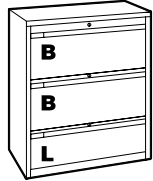

3 Drawer Lateral File

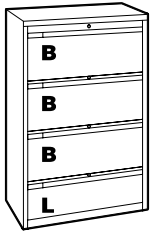

4 Drawer Lateral File

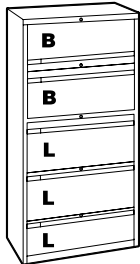

5 Drawer Lateral File

MODEL#	DIMENSIONS	FREIGHT CLASS	WT/LBS.	CUBIC FT.	LIST PRICE
--------	------------	---------------	---------	-----------	------------

D x W x H

9130P-2FSH	18 x 30 x 27.12	92.5	116	10	\$1235
9136P-2FSH	18 x 36 x 27.12	92.5	125	12	\$1282
9142P-2FSH	18 x 42 x 27.12	100	134	14	\$1327

Two fixed front drawers. **All drawers feature security panel, individual lock and side-to-side hanging file bars.**

9130P-3FSH	18 x 30 x 40.5	92.5	162	15	\$1683
9136P-3FSH	18 x 36 x 40.5	92.5	182	18	\$1745
9142P-3FSH	18 x 42 x 40.5	100	203	21	\$1807

Three fixed front drawers. **All drawers feature security panel, individual lock and side-to-side hanging file bars.**

9130P-4FSH	18 x 30 x 54	92.5	208	20	\$2130
9136P-4FSH	18 x 36 x 54	100	235	24	\$2200
9142P-4FSH	18 x 42 x 54	100	262	28	\$2272

Four fixed front drawers. **All drawers feature security panel, individual lock and side-to-side hanging file bars.**

9130P-5FSH	18 x 30 x 65.25	92.5	257	25	\$2637
9136P-5FSH	18 x 36 x 65.25	92.5	292	29	\$2731
9142P-5FSH	18 x 42 x 65.25	100	327	34	\$2826

Four fixed front drawers plus top drawer with receding door and roll-out shelf. **All drawers feature security panel, individual lock and side-to-side hanging file bars.**

Required Specifications

Metal Finish

Optional Specifications

Counterweight

Accessories

Front to Back File Bars
Plate Dividers

L 9100 LATERAL FILES

9100 SERIES - FIXED DRAWERS

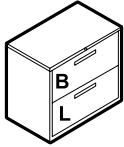

2 Drawer Lateral File

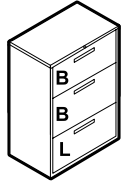

3 Drawer Lateral File

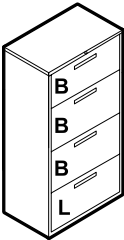

4 Drawer Lateral File

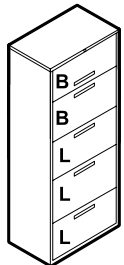

5 Drawer Lateral File



Posting Shelf

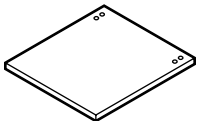

Counter Weight Balance

MODEL#	DIMENSIONS D x W x H	FREIGHT CLASS	WT/LBS.	CUBIC FT.	LIST PRICE
9130-2F1H	18 x 30 x 27.12	92.5	108	10	\$724
9136-2F1H	18 x 36 x 27.12	100	115	12	\$769
9142-2F1H	18 x 42 x 27.12	100	123	14	\$887

Two fixed front drawers. Side-to-side hanging file bars included.

9130-3F1H	18 x 30 x 40.5	100	146	15	\$938
9136-3F1H	18 x 36 x 40.5	100	164	18	\$1027
9142-3F1H	18 x 42 x 40.5	100	182	21	\$1174

Three fixed front drawers. Side-to-side hanging file bars included.

9130-4F1H	18 x 30 x 54	100	185	20	\$1197
9136-4F1H	18 x 36 x 54	100	208	24	\$1314
9142-4F1H	18 x 42 x 54	100	231	28	\$1492

Four fixed front drawers. Side-to-side hanging file bars included.

9130-5F1H	18 x 30 x 65.25	100	228	25	\$1587
9136-5F1H	18 x 36 x 65.25	100	258	29	\$1632
9142-5F1H	18 x 42 x 65.25	100	288	34	\$1883

Four fixed front drawers plus top drawer with receding door and roll-out shelf. Side-to-side hanging file bars included.

91PS30	--	--	--	--	\$57
91PS36	--	--	--	--	\$63
91PS42	--	--	--	--	\$70

Available in 5 drawer only between 2nd and 3rd opening. Must be factory installed.

Counter Weight for 2 Drawer	--	**	--	\$149
Counter Weight for 3 Drawer	--	**	--	\$129
Counter Weight for 4 Drawer	--	**	--	\$109
Counter Weight for 5 Drawer	--	**	--	\$89

Recommended for use in 30", 36" & 42" wide 2, 3, 4 & 5 drawer free standing laterals. Must be factory installed.

** Weight varies depending on which file cabinet the counter weight is used on.

Required Specifications

Metal Finish

Optional Specifications

Counterweight

Accessories

Front to Back File Bars
Plate Dividers

9100 SERIES - RECEDING DRAWERS

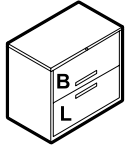

2 Drawer Lateral File

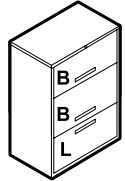

3 Drawer Lateral File

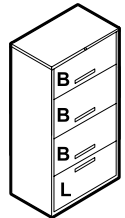

4 Drawer Lateral File

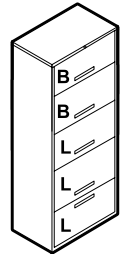

5 Drawer Lateral File

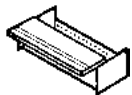

Converter

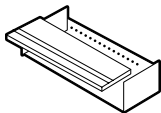

Receding Door & Roll-Out Shelf Converter

MODEL#	DIMENSIONS	FREIGHT CLASS	WT/LBS.	CUBIC FT.	LIST PRICE
--------	------------	---------------	---------	-----------	------------

D x W x H

9130-2R1H	18 x 30 x 27.12	92.5	108	10	\$784
9136-2R1H	18 x 36 x 27.12	100	115	12	\$843
9142-2R1H	18 x 42 x 27.12	100	123	14	\$932

One receding door with roll-out shelf. Bottom drawer fixed front. Side-to-side hanging file bars included.

9130-3R1H	18 x 30 x 40.5	100	146	15	\$1027
9136-3R1H	18 x 36 x 40.5	100	164	18	\$1130
9142-3R1H	18 x 42 x 40.5	100	182	21	\$1278

Two receding doors with roll-out shelves. Bottom drawer fixed front. Side-to-side hanging file bars included.

9130-4R1H	18 x 30 x 54	100	185	20	\$1300
9136-4R1H	18 x 36 x 54	100	208	24	\$1446
9142-4R1H	18 x 42 x 54	100	231	28	\$1638

Three receding doors with roll-out shelves. Bottom drawer fixed front. Side-to-side hanging file bars included.

9130-5R1H	18 x 30 x 65.25	100	228	25	\$1721
9136-5R1H	18 x 36 x 65.25	100	258	29	\$1837
9142-5R1H	18 x 42 x 65.25	100	288	34	\$2030

Four receding doors with roll-out shelves. Bottom drawer fixed front. Side-to-side hanging file bars included.

FSC30	30" w	--	--	--	N/C
FSC36	36" w	--	--	--	N/C
FSC42	42" w	--	--	--	N/C

Converts top drawer on 5 drawer model to fixed slotted shelf with a receding door.

RRC30	30" w	--	--	--	\$51
RRC36	36" w	--	--	--	\$51
RRC42	42" w	--	--	--	\$51

Applies to receding door file cabinets only. Bottom drawer only. Must be factory installed. **Add \$51.00 to List Price**

Required Specifications

Metal Finish

Optional Specifications

Counterweight

Accessories

Front to Back File Bars
Plate Dividers

L 9100 LATERAL FILES

9100 SERIES - FIXED DRAWERS, SECURITY FILES



2 Drawer Lateral File



4 Drawer Lateral File

MODEL#	DIMENSIONS	FREIGHT CLASS	WT/LBS.	CUBIC FT.	LIST PRICE
--------	------------	---------------	---------	-----------	------------

D x W x H

9136-2FSP	18 x 36 x 26.62	85	170	12	\$1075
-----------	-----------------	----	-----	----	---------------

Two fixed front drawers. Includes hasp to receive padlock and side-to-side hanging file bars. Padlock not included.

9136-4FSP	18 x 36 x 51	100	208	22.21	\$1612
-----------	--------------	-----	-----	-------	---------------

Four fixed front drawers. Includes hasp to receive padlock and side-to-side hanging file bars. Padlock not included.

Required Specifications

Metal Finish

Optional Specifications

Counterweight

Accessories

Front to Back File Bars
Plate Dividers

LATERAL FILE ACCESSORIES

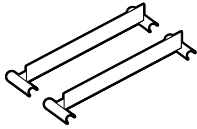

Front-to-Back Hanging File Bars

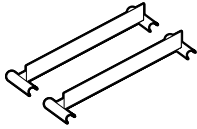

**Front-to-Back Hanging File Bars
9100 Series, 1200 Series Lateral Files**



Plate Dividers



Half Height Plate Dividers

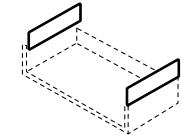

Side Adapters

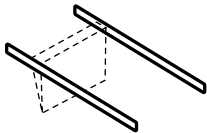

Side-to-Side Hanging File Bars



Extra Key

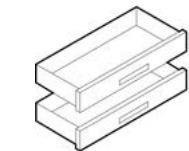

**Half-Height Drawers (per opening)
9100 Series**

MODEL#	DIMENSIONS	FREIGHT CLASS	WT/LBS.	CUBIC FT.	LIST PRICE
--------	------------	---------------	---------	-----------	------------

D x W x H

FBB	-- x 15.2 x --	70	1	.10	\$16
FBB-50	-- x 15.2 x --	60	50	.50	\$559
FBB-100	-- x 15.2 x --	60	100	2.71	\$1025

Includes two bars. Grey. FBB is one pair; FBB-50 is fifty pairs; FBB-100 is 100 pairs.

- Not recommended for "L" opening with receding door and roll-out shelves.

FBBEFC	-- x 15.2 x --	70	1	.10	\$16
FBB-50EFC	-- x 15.2 x --	60	50	.50	\$559
FBB-100EFC	-- x 15.2 x --	60	100	2.71	\$1025

Includes two bars. Textured dark grey. FBBEFC is one pair; FBB-50EFC is fifty pairs; FBB-100EFC is 100 pairs.

- Not recommended for "L" opening with receding door and roll-out shelves.

PD	--	60	4	.10	\$24
----	----	----	---	-----	-------------

Three per package. Grey.

HPD	--	100	2	.10	\$68
EXHHPD	--	60	2	.01	\$99

Three per package. Grey. Select EXHHPD for full depth half height plate divider.

EDPS	--	60	3	.10	\$31
------	----	----	---	-----	-------------

One pair. Grey. For two point suspension printout style binders. Must be used with side-to-side file bars. One pair required for each drawer.

- Not recommended in receding door applications.

HBF30	30 w	60	4	.10	\$31
HBF36	36 w	60	4	.10	\$31
HBF42	42 w	60	4	.10	\$31

One pair. Grey. For 30", 36" or 42" widths. Included in standard product.

EK93	--	--	--	--	\$10
------	----	----	----	----	-------------

Specify core #. Key range W401-W550.

91-BHHD30	-- x 30 x --	--	--	--	\$152
91-BHHD36	-- x 36 x --	--	--	--	\$152
91-BHHD42	-- x 42 x --	--	--	--	\$152
91-LHHD30	-- x 30 x --	--	--	--	\$152
91-LHHD36	-- x 36 x --	--	--	--	\$152
91-LHHD42	-- x 42 x --	--	--	--	\$152

One pair. For 30", 36" and 42" openings on 9100 and 9100P Series. Specify BHHD models for "B" openings and LHHD for "L" openings. Must be factory installed.

- Specify model by series; i.e. order 91-_HHD30 for 9100 Series; order 91P-_HHD30 for 9100P Series

L LATERAL FILES - ACCESSORIES

LATERAL FILE ACCESSORIES

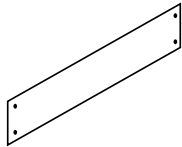

Lateral Mounting Bracket

Must be used to secure a 2 high storage cabinet unit on top of a 2, 3, 4 or 5 high lateral. Available in Black.

MODEL#	DIMENSIONS	FREIGHT CLASS	WT/LBS.	CUBIC FT.	LIST PRICE
LMB30	-- x -- x --	60	2.40	.01	\$50
LMB36	-- x -- x --	60	3	.01	\$50
LMB42	-- x -- x --	60	3.50	.01	\$50

D x W x H

LATERAL FILE TOPS

LATERAL FILE TOP NOTES:

Available finishes:

ACJ	Absolute Acajou	CSJ	Constellation Java	SOG	Storm Grey	WHC	White Chocolate
ASN	Asian Night	DES	Dark Espresso	TFW	Tiger Fruitwood	WGY	Willow Grey
AWC	Avant Cherry	GRY	Grey	TMA	Tiger Mahogany	WCR	Winter Cherry
AWH	Avant Honey	HGT	Hayden Grey (Taupe)	TMP	Tiger Maple		
BLK	Black	QTM	Quartered Mahogany	TWL	Tiger Walnut		
BRC	Brushed Cobalt	SKB	Shaker Cherry	WHT	White		

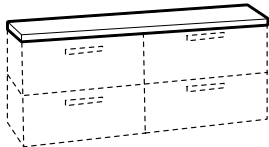
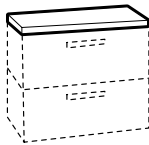

Lateral File Tops

		D x W x H					
30" wide	T1830	18 x 30 x 1.13	70	15	1	\$144	
36" wide	T1836	18 x 36 x 1.13	70	18	1	\$173	
42" wide	T1842	18 x 42 x 1.13	70	21	1	\$201	
60" wide	T1860	18 x 60 x 1.13	70	30	2	\$285	
72" wide	T1872	18 x 72 x 1.13	70	36	2	\$340	
84" wide	T1884	18 x 84 x 1.13	70	42	2	\$396	
96" wide	T1896	18 x 96 x 1.13	60	50.25	1	\$443	
108" wide	T18108	18 x 108 x 1.13	70	54	3	\$493	

1 1/8" thick laminate tops for placement over metal files or File Taxi. Coordinates with Global casegoods. Finish options are listed above.

• Contact Global for pricing on special size tops.

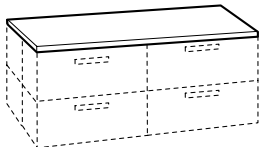
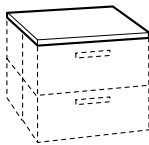

Lateral File Tops - Back to Back

30" wide	T3630	36 x 30 x 1.13	60	32	.65	\$276
36" wide	T3636	36 x 36 x 1.13	60	34.25	.75	\$332
42" wide	T3642	36 x 42 x 1.13	60	36.50	.90	\$387
60" wide	T3660	36 x 60 x 1.13	60	41	1.25	\$552
72" wide	T3672	36 x 72 x 1.13	60	45.25	1.50	\$663
84" wide	T3684	36 x 84 x 1.13	65	49.50	1.75	\$774
90" wide	T3690	36 x 90 x 1.13	65	51.75	1.90	\$885
96" wide	T3696	36 x 96 x 1.13	65	54	2	\$885
108" wide	T36108	36 x 108 x 1.13	65	58.25	2.25	\$994

1 1/8" thick laminate tops for placement over back-to-back metal files. Coordinates with Global casegoods. Finish options are listed above.

• Contact Global for pricing on special size tops.

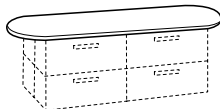

Lateral File Tops - Racetrack with 18" radius

96" wide	T3696R	36 x 96 x 1.13	60	71.50	2	\$885
108" wide	T36108R	36 x 108 x 1.13	60	112	2.25	\$994
120" wide	T36120R	36 x 120 x 1.13	60	123	2.50	\$1105

1 1/8" thick laminate tops for placement over metal files or File Taxi. Coordinates with Global casegoods. Finish options are listed above.

• Contact Global for pricing on special size tops.

Required Specifications

Laminate Finish (tops)

LATERAL FILE ACCESSORIES

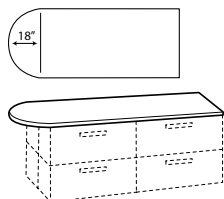

Lateral File Tops - D-Top w/18" radius

MODEL#	DIMENSIONS	FREIGHT CLASS	WT/LBS.	CUBIC FT.	LIST PRICE	
D x W x H						
48" wide	T3648D	36 x 48 x 1.13	60	50	1	\$443
54" wide	T3654D	36 x 54 x 1.13	60	56	1.15	\$552
60" wide	T3660D	36 x 60 x 1.13	60	62	1.25	\$552
78" wide	T3678D	36 x 78 x 1.13	60	81	1.65	\$774
90" wide	T3690D	36 x 90 x 1.13	60	94	1.90	\$885
102" wide	T36102D	36 x 102 x 1.13	60	106.75	2.15	\$1105

1 1/8" thick laminate tops for placement over metal files or File Taxi. Coordinates with Global casegoods. Finish options are listed above.

• Contact Global for pricing on special size tops.

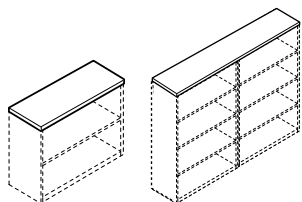

Laminate Tops for bookcases

30" wide	T1330	13 x 30 x 1.13	60	11.50	.25	\$138
36" wide	T1336	13 x 36 x 1.13	60	13.75	.27	\$167
42" wide	T1342	13 x 42 x 1.13	60	15.75	.30	\$221
60" wide	T1360	13 x 60 x 1.13	60	20	.45	\$276
72" wide	T1372	13 x 72 x 1.13	60	24	.55	\$332
84" wide	T1384	13 x 72 x 1.13	60	28	.65	\$443

1 1/8" thick laminate tops for placement over metal bookcases. Coordinates with Global casegoods. Finish options are listed above.

• Contact Global for pricing on special size tops.

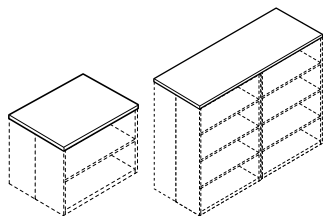

Laminate Tops for bookcases

30" wide	T2630	26 x 30 x 1.13	60	22.50	.45	\$230
36" wide	T2636	26 x 36 x 1.13	60	27	.54	\$276
42" wide	T2642	26 x 42 x 1.13	60	31	.60	\$368
60" wide	T2660	26 x 60 x 1.13	60	45	.90	\$460
72" wide	T2672	26 x 72 x 1.13	60	54	1.10	\$552
84" wide	T2684	26 x 84 x 1.13	60	63	1.30	\$737

1 1/8" thick laminate tops for placement over metal bookcases. Coordinates with Global casegoods. Finish options are listed above.

• Contact Global for pricing on special size tops.

FILE BUDDY



File Buddy Swivel Stool

MODEL#	DIMENSIONS	FREIGHT CLASS	WT/LBS.	CUBIC FT.	GRADE	LIST	GRADE	LIST
1105	14 x 14 x 18.5	125	19	2.90	1	\$262	8	\$381
					2	\$271	9	\$403
					3	\$281	10	\$455
					4	\$298	11	\$479
					5	\$313	12	\$525
					6	\$335	13	\$591
					7	\$365	14	\$671

5" pneumatic adjustable height stool from **16 1/4" to 21 1/4"**. Black, 5-legged, injection molded base. 12" diameter seat. C65 casters are standard. Shipped RTA (ready to assemble). COM Yardage: 0.75

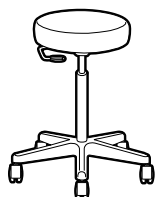

File Buddy Swivel Stool

1110	14 x 14 x 27.5	125	20	2.90	1	\$308	8	\$427
					2	\$316	9	\$448
					3	\$328	10	\$500
					4	\$343	11	\$524
					5	\$359	12	\$571
					6	\$382	13	\$637
					7	\$411	14	\$718

5" pneumatic adjustable height stool from **22 1/4" to 32 1/4"**. Black, 5-legged, injection molded base. 12" diameter seat. C65 casters are standard. Shipped RTA (ready to assemble). COM Yardage: 0.75

Required Specifications

Laminate Finish (tops)
Fabric (File Buddy)

P 9300P PERSONAL TOWERS

9300P SERIES PERSONAL TOWERS

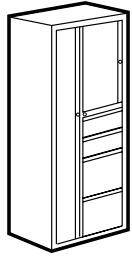

Personal Tower - 2 Box/2 File Drawers

MODEL#	DIMENSIONS D x W x H	FREIGHT CLASS	WT/LBS.	CUBIC FT.	LIST PRICE
93PT-2B2FL	24 x 24 x 65.25	125	170	21.75	\$1500
93PT-2B2FR	24 x 24 x 65.25	125	170	21.75	\$1500

- Model 93PT-2B2FL has wardrobe section on the left and file drawers on the right.
- Model 93PT-2B2FR has wardrobe section on the right and file drawers on the left.

Full looped pulls on all drawers. Includes ventilated 24"D wardrobe section, locker compartment and 2 box and 2 file drawers. Locker compartment includes 2 shelves. Locking.

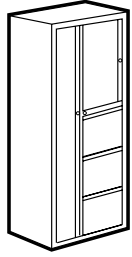

Personal Tower - 3 File Drawers

93PT-3FL	24 x 24 x 65.25	125	165	21.75	\$1500
93PT-3FR	24 x 24 x 65.25	125	165	21.75	\$1500

- Model 93PT-3FL has wardrobe section on the left and file drawers on the right.
- Model 93PT-3FR has wardrobe section on the right and file drawers on the left.

Full looped pulls on all drawers. Includes ventilated 24"D wardrobe section, locker compartment and 3 file drawers. Locker compartment includes 2 shelves. Locking.

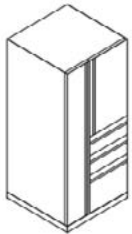

Personal Tower - 2 Box/1 File Drawers

93PT4-2BFL	24 x 24 x 54	125	135	18	\$1450
93PT4-2BFR	24 x 24 x 54	125	135	18	\$1450

- Model 93PT4-2BFL has wardrobe section on the left and file drawers on the right.
- Model 93PT4-2BFR has wardrobe section on the right and file drawers on the left.

Full looped pulls on all drawers. Includes ventilated 24"D wardrobe section, locker compartment and 2 file drawers. Locker compartment includes 1 shelf. Locking.

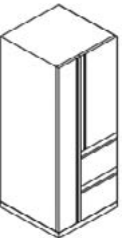

Personal Tower - 2 File Drawers

93PT4-2FL	24 x 24 x 54	125	132	18	\$1450
93PT4-2FR	24 x 24 x 54	125	132	18	\$1450

- Model 93PT4-2FL has wardrobe section on the left and file drawers on the right.
- Model 93PT4-2FR has wardrobe section on the right and file drawers on the left.

Full looped pulls on all drawers. Includes ventilated 24"D wardrobe section, locker compartment and 2 file drawers. Locker compartment includes 1 shelf. Locking.

Required Specifications

Metal Finish

9700 SERIES PERSONAL TOWERS

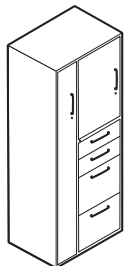

Personal Tower - 2 Box/2 File Drawers

MODEL# DIMENSIONS FREIGHT CLASS WT/LBS. CUBIC FT. LIST PRICE

D x W x H

97PT-2B2FL	24 x 24 x 65.25	125	170	21.75	\$1511
97PT-2B2FR	24 x 24 x 65.25	125	170	21.75	\$1511

Slimline satin aluminum handle pull on all drawers. Includes ventilated 24"D wardrobe section, locker compartment and 2 box and 2 file drawers. Locker compartment includes 2 shelves. Locking.

- Model 97PT-2B2FL has wardrobe section on the left and file drawers on the right.
- Model 97PT-2B2FR has wardrobe section on the right and file drawers on the left.

9100 SERIES PERSONAL TOWERS

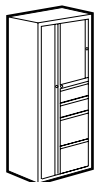

Personal Tower - 2 Box/2 File Drawers

9PT5-2B2FL	24 x 24 x 65.25	100	182	21.75	\$1909
9PT5-2B2FR	24 x 24 x 65.25	100	182	21.75	\$1909

Full looped pulls on all drawers. Includes ventilated 24"D wardrobe section, locker compartment and 2 box and 2 file drawers. Locker compartment includes 2 shelves. Locking.

- Model **9PT5-2B2FL** has wardrobe section on the left and file drawers on the right.
- Model **9PT5-2B2FR** has wardrobe section on the right and file drawers on the left.

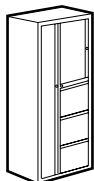

Personal Tower - 3 File Drawers

9PT5-3FL	24 x 24 x 65.25	100	182	21.75	\$1909
9PT5-3FR	24 x 24 x 65.25	100	182	21.75	\$1909

Full looped pulls on all drawers. Includes ventilated 24"D wardrobe section, locker compartment and 3 file drawers. Locker compartment includes 2 shelves. Locking

- Model **9PT5-3FL** has wardrobe section on the left and file drawers on the right.
- Model **9PT5-3FR** has wardrobe section on the right and file drawers on the left.

Required Specifications

Metal Finish

P 1200P PERSONAL TOWERS

1200P SERIES - PERSONAL TOWERS

MODEL#	DIMENSIONS	FREIGHT CLASS	WT/LBS.	CUBIC FT.	LIST PRICE
--------	------------	---------------	---------	-----------	------------

D x W x H

1224P42TBBFL	24 x 24 x 42	125	112	16.37	\$1500
1224P48TBBFL	24 x 24 x 48	125	135	18.63	\$1565
1224P50TBBFL	24 x 24 x 50	125	146	19.38	\$1565
1224P54TBBFL	24 x 24 x 54	125	152	20.88	\$1565
1224P66TBBFL	24 x 24 x 66	125	162	25.36	\$1615
1224P42TBBFR	24 x 24 x 42	125	112	16.37	\$1500
1224P48TBBFR	24 x 24 x 48	125	135	18.63	\$1565
1224P50TBBFR	24 x 24 x 50	125	146	19.38	\$1565
1224P54TBBFR	24 x 24 x 54	125	152	20.88	\$1565
1224P66TBBFR	24 x 24 x 66	125	162	25.36	\$1615

- 1224PxxTBBFL models have wardrobe on the **left** and file drawers on the **right**
- 1224PxxTBBFR models have wardrobe on the **right** and file drawers on the **left**

Includes ventilated 24"D wardrobe section, locker compartment and 2 box and 1 file drawer. Storage tower has 1 adjustable shelf and 1 fixed shelf. Full height coat storage is 7" wide with ventilation. Tower comes with 3 locks - 1 for the drawers, 1 for the storage door and 1 for the coat locker.

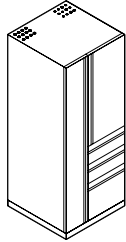

Left Shown

Personal Tower - Box/Box/File

1224P42TFFL	24 x 24 x 42	125	116	16.37	\$1500
1224P48TFFL	24 x 24 x 48	125	128	18.63	\$1565
1224P50TFFL	24 x 24 x 50	125	146	19.38	\$1565
1224P54TFFL	24 x 24 x 54	125	150	20.88	\$1565
1224P66TFFL	24 x 24 x 66	125	160	25.36	\$1615

1224P42TFFR	24 x 24 x 42	125	116	16.37	\$1500
1224P48TFFR	24 x 24 x 48	125	128	18.63	\$1565
1224P50TFFR	24 x 24 x 50	125	146	19.38	\$1565
1224P54TFFR	24 x 24 x 54	125	150	20.88	\$1565
1224P66TFFR	24 x 24 x 66	125	160	25.36	\$1615

- 1224PxxTFFL models have wardrobe on the **left** and file drawers on the **right**
- 1224PxxTFFR models have wardrobe on the **right** and file drawers on the **left**

Includes ventilated 24"D wardrobe section, locker compartment and 2 file drawers. Storage tower has 1 adjustable shelf and 1 fixed shelf. Full height coat storage is 7" wide with ventilation. Tower comes with 3 locks - 1 for the drawers, 1 for the storage door and 1 for the coat locker.

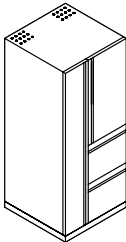

Left Shown

Personal Tower - File/File

1224P50TSOBBFL	24 x 24 x 50	125	150	19.38	\$1980
1224P54TSOBBFL	24 x 24 x 54	125	150	20.88	\$1990
1224P66TSOBBFL	24 x 24 x 66	125	158	25.36	\$2025

1224P50TSOBBFR	24 x 24 x 50	125	150	19.38	\$1980
1224P54TSOBBFR	24 x 24 x 54	125	150	20.88	\$1990
1224P66TSOBBFR	24 x 24 x 66	125	158	25.36	\$2025

- 1224PxxTSOBBFL models have wardrobe on the **left** and file drawers on the **right**
- 1224PxxTSOBBFR models have wardrobe on the **right** and file drawers on the **left**

Includes ventilated 24"D wardrobe section and 2 box and 1 file drawers. Storage tower has 1 adjustable shelf and 1 fixed shelf. Full height coat storage is 7" wide with ventilation. Tower comes with 2 locks - 1 for the drawers, 1 for the coat locker.

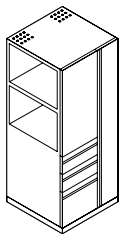

Right Shown

Side Opening Storage Tower - Box/Box/File

Required Specifications

Metal Finish

1200P SERIES - PERSONAL TOWERS

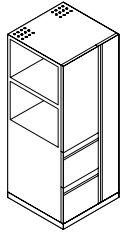

Right Shown

Side Opening Storage Tower - File/File

MODEL#	DIMENSIONS	FREIGHT CLASS	WT/LBS.	CUBIC FT.	LIST PRICE
--------	------------	---------------	---------	-----------	------------

D x W x H

1224P50TSOFFL	24 x 24 x 50	125	146	19.38	\$1980
1224P54TSOFFL	24 x 24 x 54	125	150	20.88	\$1990
1224P66TSOFFL	24 x 24 x 66	125	158	25.36	\$2025
1224P50TSOFFR	24 x 24 x 50	125	146	19.38	\$1980
1224P54TSOFFR	24 x 24 x 54	125	150	20.88	\$1990
1224P66TSOFFR	24 x 24 x 65.88	125	158	25.36	\$2025

- 1224PxxTSOFFL models have wardrobe on the **left** and file drawers on the **right**
- 1224PxxTSOFFR models have wardrobe on the **right** and file drawers on the **left**

Includes ventilated 24"D wardrobe section and 2 file drawers. Storage tower has 1 adjustable shelf and 1 fixed shelf. Full height coat storage is 7" wide with ventilation. Tower comes with 2 locks - 1 for the drawers, 1 for the coat locker.

WARDROBE LOCKERS

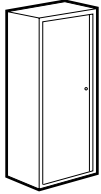

Wardrobe Locker



Wardrobe Locker

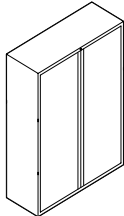

Wardrobe Cabinet - 5 high

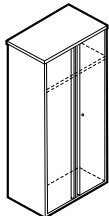

Two Door Wardrobe Cabinet - 65 1/4" High

9PL2472SDL	24 x 24 x 72	125	182	25	\$1504
9PL2472SDR	24 x 24 x 72	125	182	25	\$1504

Full loop pull on door. Includes two adjustable shelves. Hanging rod. Locking.

- Model **9PL2472SDL** door opens to the **left**.
- Model **9PL2472SDR** door opens to the **right**.

91PL518L	24 x 18 x 65.25	125	125	16.30	\$1058
91PL518R	24 x 18 x 65.25	125	125	16.30	\$1058

Full loop pull on door. Includes one adjustable shelf. Hanging rod. Locking.

- Model **91PL518L** door opens to the **left**.
- Model **91PL518R** door opens to the **right**.

1230P5W	18 x 30 x 65.88	150	118.50	23.95	\$1042
1236P5W	18 x 36 x 65.88	150	128	28.51	\$1320
1242P5W	18 x 42 x 65.88	150	135	33.08	\$1459

30" wide has full width shelf and coat rod with 4 hooks. 36" and 42" wide have full width shelf. Coat rod on right and 4 height adjustable shelves on the left side.

9130-5W1	18 x 30 x 65.25	150	136	25	\$1106
----------	-----------------	-----	-----	----	---------------

One full width, fixed, non-slotted shelf. Front-to-back coat rod and four coat hooks. Lock and levelling glides standard.

Matches lateral file case dimensions. Doors open 165°.

- Available in Full Pull Model, add "P" to model # (eg. **9130P-5W1**).
- Available with side-to-side coat rod at no charge. Please specify.

Required Specifications

Metal Finish

S 9300P STORAGE

9300P SERIES STORAGE CABINETS

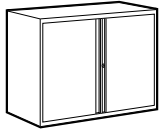

Two Door Storage Cabinet - 27 1/8" H

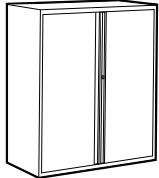

Two Door Storage Cabinet - 42" H

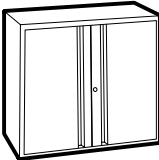

Two Door Storage Cabinet - 40 1/2" H

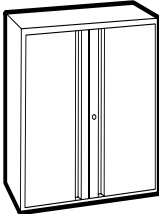

Two Door Storage Cabinet - 54" H

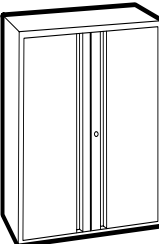

Two Door Storage Cabinet - 65 1/4" H

MODEL#	DIMENSIONS D x W x H	FREIGHT CLASS	WT/LBS.	CUBIC FT.	LIST PRICE
9330P-2S1	18 x 30 x 27.12	150	57	10	\$346
9336P-2S1	18 x 36 x 27.12	150	61	14	\$373
9342P-2S1	18 x 42 x 27.12	150	73	14	\$401

One full width, **fixed**, non-slotted shelf. Lock and levelling glides standard. **Matches lateral file case dimensions. Full pull handle design.**

- When used as a stack-on over file, storage cabinets and lateral files must be bolted together; when possible, bolted to an adjacent wall.
- All shelves were tested to hold up to 70 - 75 lbs. evenly distributed.

9336P-S42L	18 x 36 x 42	150	98	20	\$416
------------	--------------	-----	----	----	--------------

One fixed and one adjustable shelf. Lock and levelling glides standard. **Full pull handle design.**

- All shelves were tested to hold up to 70 - 75 lbs. evenly distributed.

9330P-3S1	18 x 30 x 40.5	150	80	17	\$392
9336P-3S1	18 x 36 x 40.5	150	88	21	\$411
9342P-3S1	18 x 42 x 40.5	150	100	24	\$434

One fixed and one adjustable shelf. Lock and levelling glides standard. **Matches lateral file case dimensions. Full pull handle design.**

- All shelves were tested to hold up to 70 - 75 lbs. evenly distributed.

9330P-4S1	18 x 30 x 54	150	102	23	\$434
9336P-4S1	18 x 36 x 54	150	111	27	\$452
9342P-4S1	18 x 42 x 54	150	125	31	\$484

One fixed and two adjustable shelves. Lock and levelling glides standard. **Matches lateral file case dimensions. Full pull handle design.**

- All shelves were tested to hold up to 70 - 75 lbs. evenly distributed.

9330P-5S1	18 x 30 x 65.25	150	122	27	\$471
9336P-5S1	18 x 36 x 65.25	150	134	32	\$500
9342P-5S1	18 x 42 x 65.25	150	150	37	\$528

One fixed and three adjustable shelves. Lock and levelling glides standard. **Matches lateral file case dimensions. Full pull handle design.**

- All shelves were tested to hold up to 70 - 75 lbs. evenly distributed.

Required Specifications

Metal Finish

Optional Specifications

Counterweight

Accessories

Front to Back File Bars
Plate Dividers

9300P SERIES STORAGE

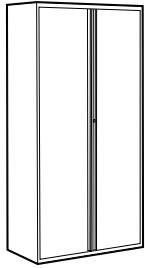

Two Door Storage Cabinet - 72" H

MODEL#	DIMENSIONS	FREIGHT CLASS	WT/LBS.	CUBIC FT.	LIST PRICE
--------	------------	---------------	---------	-----------	------------

D x W x H

9336P-S72L	18 x 36 x 72	250	133	36	\$516
------------	--------------	-----	-----	----	--------------

One fixed and three adjustable shelves. Lock and levelling glides standard. **Full pull handle design.**

- All shelves were tested to hold up to 70 - 75 lbs. evenly distributed.



Additional Shelf

9330P-FWS	--	--	--	--	\$34
9336P-FWS	--	--	--	--	\$37
9342P-FWS	--	--	--	--	\$42

For use with 9300P Series storage cabinets.

9300P SERIES MULTI-STOR

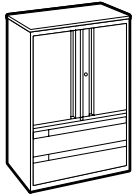

Multi-Stor Cabinet

9336P-5MSL	18 x 36 x 65.25	125	245	32	\$1054
------------	-----------------	-----	-----	----	---------------

All purpose storage unit with two fixed shelves, one adjustable shelf and standard side-to-side hanging file bars in the roll-out drawers. **Full pull handle design.**

- Storage and lateral units lock independently and are keyed alike.

9300P SERIES EXHIBIT CABINET

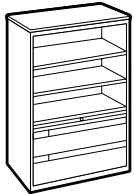

Exhibit Cabinet

9336P-5FX	18 x 36 x 65.25	125	230	32	\$984
-----------	-----------------	-----	-----	----	--------------

Open shelving with one fixed and two adjustable shelves, Two lateral file drawers. Side-to-side hanging file bars included. Locking. **Full pull handle design.**

Required Specifications
Metal Finish

Optional Specifications
Counterweight

Accessories
Front to Back File Bars
Plate Dividers

S 9300 STORAGE

9300 SERIES STORAGE CABINETS

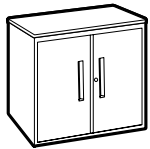

Two Door Storage Cabinet - 27 1/8" H

MODEL#	DIMENSIONS D x W x H	FREIGHT CLASS	WT/LBS.	CUBIC FT.	LIST PRICE
9336-2S1	18 x 36 x 27.12	150	61	14	\$373

One full width, **fixed**, non-slotted shelf. Lock and levelling glides standard. **Matches lateral file case dimensions.**

- When used as a stack-on over file, storage cabinets and lateral files must be bolted together; when possible, bolted to an adjacent wall.
- All shelves were tested to hold up to 70 - 75 lbs. evenly distributed.

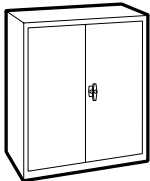

Two Door Storage Cabinet - 42" H

9336-S42L	18 x 36 x 42	150	88	20	\$416
-----------	--------------	-----	----	----	--------------

One fixed and one adjustable shelf. Lock and levelling glides standard.

- All shelves were tested to hold up to 70 - 75 lbs. evenly distributed.

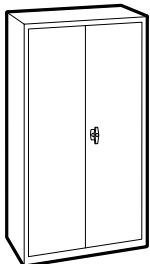

Two Door Storage Cabinet - 72" H

9336-S72L	18 x 36 x 72	250	130	36	\$516
-----------	--------------	-----	-----	----	--------------

One fixed and three adjustable shelves. Lock and levelling glides standard.

- All shelves were tested to hold up to 70 - 75 lbs. evenly distributed.

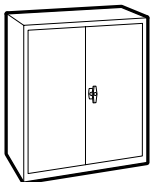

Two Door Storage Cabinet - 42" H

93CG-S42L	18 x 36 x 42	150	98	20	\$475
-----------	--------------	-----	----	----	--------------

Two adjustable shelves. Two point locking doors.

- CGSB approved
- All shelves were tested to hold up to 125 lbs. evenly distributed.

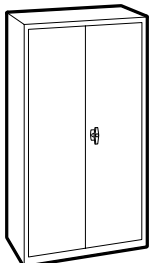

Two Door Storage Cabinet - 72" H

93CG-S72L	18 x 36 x 72	150	158	36	\$574
-----------	--------------	-----	-----	----	--------------

Six adjustable shelves. Two point locking doors.

- CGSB approved
- All shelves were tested to hold up to 125 lbs. evenly distributed.

Required Specifications

Metal Finish

9300 SERIES STORAGE CABINETS



Additional Shelf

MODEL#	DIMENSIONS	FREIGHT CLASS	WT/LBS.	CUBIC FT.	LIST PRICE
	D x W x H				
9336-FWS	18 x 36 x .75	85	7	.50	\$37
93CG-FWS	18 x 36 x .75	85	7	.50	\$61

Specify **9336-FWS** for 9336-5MSL, 9336-S72L, 9336-S42L, 9336-2SL and 9700 series storage cabinets.
Specify **93CG-FWS** for 93CG Storage Cabinets.

9300 SERIES MULTI-STOR

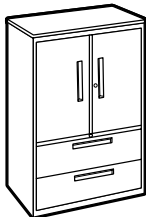

Multi-Stor Cabinet

9336-5MSL	18 x 36 x 65.25	125	200	32	\$1054
-----------	-----------------	-----	-----	----	---------------

All purpose storage unit with two fixed shelves, one adjustable shelf and standard side-to-side hanging file bars in the roll-out drawers. Center pull handle design

- Storage and lateral units lock independently and are keyed alike.

9700 SERIES STORAGE CABINETS

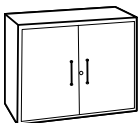

Two Door Storage Cabinet - 27 1/8" H

9736-2S1	18 x 36 x 27.13	150	61	14	\$443
----------	-----------------	-----	----	----	--------------

One full width, **fixed**, non-slotted shelf. **Slimline satin aluminum handles.** Lock and levelling glides standard. Matches lateral file case dimensions.

- When used as a stack-on over file, storage cabinets and lateral files must be bolted together; when possible, bolted to an adjacent wall.
- All shelves were tested to hold up to 70 - 75 lbs. evenly distributed.



Two Door Storage Cabinet - 42" H

9736-S42L	18 x 36 x 42	150	98	20	\$540
-----------	--------------	-----	----	----	--------------

One fixed and one adjustable shelf. **Slimline satin aluminum handles.** Lock and levelling glides standard.

- All shelves were tested to hold up to 70 - 75 lbs. evenly distributed.

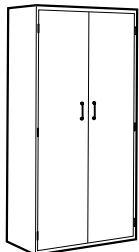

Two Door Storage Cabinet - 72" H

9736-S72L	18 x 36 x 72	250	133	36	\$693
-----------	--------------	-----	-----	----	--------------

One fixed and three adjustable shelves. **Slimline satin aluminum handles.** Lock and levelling glides standard.

- All shelves were tested to hold up to 70 - 75 lbs. evenly distributed.

Required Specifications
Metal Finish

Optional Specifications
Counterweight

Accessories
Front to Back File Bars
Plate Dividers

S 9700 / 1200 STORAGE

9300 SERIES STORAGE

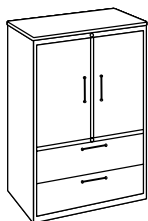

Multi-Stor Cabinet

MODEL#	DIMENSIONS D x W x H	FREIGHT CLASS	WT/LBS.	CUBIC FT.	LIST PRICE
9736-5MSL	18 x 36 x 65.25	125	245	32	\$1198

All purpose storage unit with two fixed shelves, one adjustable shelf and standard side-to-side hanging file bars in the roll-out drawers. **Slimline satin aluminum handle design.**

- Storage and lateral units lock independently and are keyed alike.

1200P SERIES STORAGE

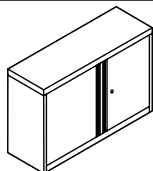

1/2 h Storage Cabinet w/Doors

1230P1XS	18 x 30 x 21.75	125	61	8.26	\$725
1236P1XS	18 x 36 x 21.75	125	71	9.84	\$775
1242P1XS	18 x 42 x 21.75	125	86	11.41	\$825

Half height open shelf and 12" open shelf lateral cabinet. 1 Adjustable shelf. Locking.

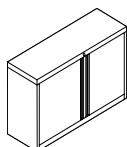

**Storage Cabinet - 2 high
Worksurface supporting**

1230P2SWS	18 x 30 x 27.75	125	74	10.40	\$645
1236P2SWS	18 x 36 x 27.75	125	82	12.38	\$684
1242P2SWS	18 x 42 x 27.75	125	91	14.36	\$789

One adjustable shelf.

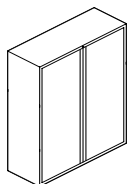

Storage Cabinet - 3 high

1230P3S	18 x 30 x 40.5	125	102	14.93	\$788
1236P3S	18 x 36 x 40.5	125	115	17.77	\$880
1242P3S	18 x 42 x 40.5	125	126	20.62	\$973

Two adjustable shelves.

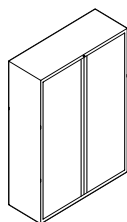

Storage Cabinet - 4 high

1230P4S	18 x 30 x 54	125	126	19.73	\$973
1236P4S	18 x 36 x 54	125	148	23.49	\$1088
1242P4S	18 x 42 x 54	150	163	27.24	\$1204

Three adjustable shelves.

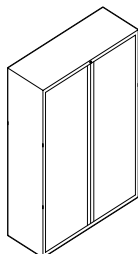

Storage Cabinet - 5 high

1230P5S	18 x 30 x 65.88	125	152	23.95	\$1088
1236P5S	18 x 36 x 65.88	125	175	28.51	\$1227
1242P5S	18 x 42 x 65.88	150	198	33.08	\$1366

Four adjustable shelves.

Required Specifications
Metal Finish

Optional Specifications
Counterweight

Accessories
Front to Back File Bars
Plate Dividers

1200 SERIES STORAGE

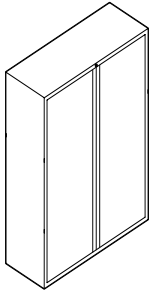

Storage Cabinet - 6 high

	MODEL#	DIMENSIONS	FREIGHT CLASS	WT/LBS.	CUBIC FT.	LIST PRICE
	D x W x H					
	1230P6S	18 x 30 x 77.88	125	174	28.22	\$1459
	1236P6S	18 x 36 x 77.88	150	195	33.59	\$1621
	1242P6S	18 x 42 x 77.88	150	220	38.97	\$1783

Five adjustable shelves.

1200 SERIES MULTI-STOR

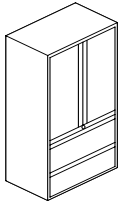

Multi-Stor Cabinet

	1230P50M2SFF	18 x 30 x 50	125	120	18.31	\$1422
	1236P50M2SFF	18 x 36 x 50	125	142	21.79	\$1598
	1242P50M2SFF	18 x 42 x 50	150	150	25.28	\$1723

All purpose storage unit with hinged doors and two lateral file drawers. Locking.

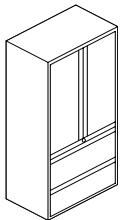

Multi-Stor Cabinet

	1230P54M2SFF	18 x 30 x 54	125	150	19.73	\$1436
	1236P54M2SFF	18 x 36 x 54	125	158	23.49	\$1482
	1242P54M2SFF	18 x 42 x 54	125	168	27.24	\$1575

All purpose storage unit with hinged doors and two lateral file drawers. Locking.

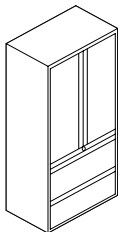

Multi-Stor Cabinet

	1230P66M3SFF	18 x 30 x 65.88	100	228	23.95	\$1769
	1236P66M3SFF	18 x 36 x 65.88	100	258	28.51	\$1815
	1242P66M3SFF	18 x 42 x 65.88	100	265	33.08	\$1908

All purpose storage unit with hinged doors and two lateral file drawers. Locking.



Multi-Stor Cabinet

	1230P66M2SFFF	18 x 30 x 65.88	100	230	23.95	\$1829
	1236P66M2SFFF	18 x 36 x 65.88	100	250	28.51	\$1852
	1242P66M2SFFF	18 x 42 x 65.88	100	280	33.08	\$1945

All purpose storage unit with hinged doors and three lateral file drawers. Locking.

Required Specifications
Metal Finish

Optional Specifications
Counterweight

Accessories
Front to Back File Bars
Plate Dividers

S 9100P STORAGE

9100P SERIES MULTI-STOR

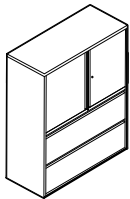

Multi-Stor Cabinet

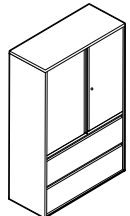

Multi-Stor Cabinet

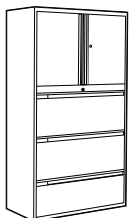

Multi-Stor Cabinet

MODEL#	DIMENSIONS	FREIGHT CLASS	WT/LBS.	CUBIC FT.	LIST PRICE
--------	------------	---------------	---------	-----------	------------

D x W x H

9130P-4MSL	18 x 30 x 54	100	199	20	\$1490
9136P-4MSL	18 x 36 x 54	100	211	24	\$1567
9142P-4MSL	18 x 42 x 54	125	223	28	\$1687

All purpose storage unit with one adjustable shelf and standard side-to-side hanging file bars in the roll-out drawers.

Full pull handle design.

- Storage and lateral units lock independently and are keyed alike.

9130P-5MSL	18 x 30 x 65.25	100	217	27	\$1606
9136P-5MSL	18 x 36 x 65.25	125	229	31	\$1743
9142P-5MSL	18 x 42 x 65.25	125	241	36	\$1880

All purpose storage unit with two adjustable shelves and standard side-to-side hanging file bars in the roll-out drawers.

Full pull handle design.

- Storage and lateral units lock independently and are keyed alike.

9130P-5MS3	18 x 30 x 65.25	100	243	27	\$1905
9136P-5MS3	18 x 36 x 65.25	100	278	31	\$1962
9142P-5MS3	18 x 42 x 65.25	100	310	36	\$2097

All purpose storage unit with one adjustable shelf and one fixed shelf. One binder and two letter height drawers. Standard side-to-side hanging file bars in the roll-out drawers. **Full pull handle design.**

- Storage and lateral units lock independently and are keyed alike.

Required Specifications

Metal Finish

Optional Specifications

Counterweight

Accessories

Front to Back File Bars
Plate Dividers

9100 SERIES MULTI-STOR

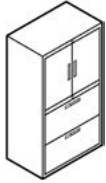

Multi-Stor Cabinet

MODEL#	DIMENSIONS D x W x H	FREIGHT CLASS	WT/LBS.	CUBIC FT.	LIST PRICE
9130-4MSL	18 x 30 x 54	100	198	20	\$1418
9136-4MSL	18 x 36 x 54	100	210	24	\$1499
9142-4MSL	18 x 42 x 54	125	222	28	\$1617

All purpose storage unit with one adjustable shelf and standard side-to-side hanging file bars in the roll-out drawers.

- Storage and lateral units lock independently and are keyed alike.

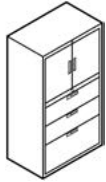

Multi-Stor Cabinet

9130-4SMSL	18 x 30 x 54	92.5	203	20	\$1525
9136-4SMSL	18 x 36 x 54	100	215	24	\$1654
9142-4SMSL	18 x 42 x 54	100	227	28	\$1793

All purpose storage unit with one adjustable shelf and one set of side-to-side hanging file bars in the bottom drawer.
Two split drawers above bottom drawer.

- Storage and lateral units lock independently and are keyed alike.

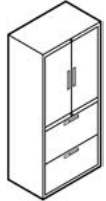

Multi-Stor Cabinet

9130-5MSL	18 x 30 x 65.25	100	217	27	\$1524
9136-5MSL	18 x 36 x 65.25	125	229	31	\$1657
9142-5MSL	18 x 42 x 65.25	125	241	36	\$1795

All purpose storage unit with two adjustable shelves and standard side-to-side hanging file bars in the roll-out drawers.

- Storage and lateral units lock independently and are keyed alike.

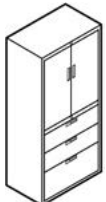

Multi-Stor Cabinet

9130-5SMSL	18 x 30 x 65.25	100	217	24	\$1681
9136-5SMSL	18 x 36 x 65.25	125	229	29	\$1813
9142-5SMSL	18 x 42 x 65.25	125	241	33	\$1952

All purpose storage unit with two adjustable shelves and one set of side-to-side hanging file bars in the bottom drawer.
Two split drawers above bottom drawer.

- Storage and lateral units lock independently and are keyed alike.

Required Specifications
Metal Finish

Optional Specifications
Counterweight

Accessories
Front to Back File Bars
Plate Dividers

S 9100 STORAGE

9100 SERIES STORAGE

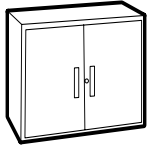

Two Door Storage Cabinet - 27 1/8" H

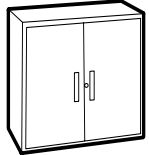

Two Door Storage Cabinet - 40 1/2" High

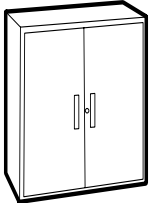

Two Door Storage Cabinet - 54" High

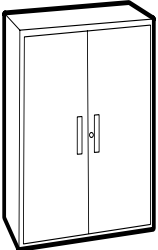

Two Door Storage Cabinet - 65 1/4" High

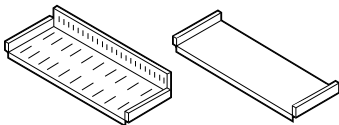

Additional Shelf

MODEL#	DIMENSIONS D x W x H	FREIGHT CLASS	WT/LBS.	CUBIC FT.	LIST PRICE
9130-2S1	18 x 30 x 27.12	125	74	10	\$608
9136-2S1	18 x 36 x 27.12	125	82	12	\$666
9142-2S1	18 x 42 x 27.12	125	91	14	\$754

One full width, **adjustable**, non-slotted shelf. Lock and levelling glides standard. **Matches lateral file case dimensions. Doors open 165°.**

- Available in Full Pull Model, add "P" to model # (eg. **9136P-2S1**).
- When used as a stack-on over file, storage cabinets and lateral files must be bolted together; when possible, bolted to an adjacent wall.

9130-3S1	18 x 30 x 40.5	125	100	15	\$768
9136-3S1	18 x 36 x 40.5	125	113	18	\$842
9142-3S1	18 x 42 x 40.5	125	126	21	\$915

Two full width, adjustable, non-slotted shelves. Lock and levelling glides standard. **Matches lateral file case dimensions. Doors open 165°.**

- Available in Full Pull Model, add "P" to model # (eg. **9136P-2S1**).
- *Not recommended to be used as a stack-on over file (see **9100-2S1**).*

9130-4S1	18 x 30 x 54	125	130	20	\$930
9136-4S1	18 x 36 x 54	125	147	24	\$1005
9142-4S1	18 x 42 x 54	150	163	28	\$1077

Three full width, adjustable, non-slotted shelves. Lock and levelling glides standard. **Matches lateral file case dimensions. Doors open 165°.**

- Available in Full Pull Model, add "P" to model # (eg. **9136P-4S1**).

9130-5S1	18 x 30 x 65.25	125	155	25	\$1093
9136-5S1	18 x 36 x 65.25	150	171	29	\$1166
9142-5S1	18 x 42 x 65.25	150	195	34	\$1239

Four full width, adjustable, non-slotted shelves. Lock and levelling glides standard. **Matches lateral file case dimensions. Doors open 165°.**

- Available in Full Pull Model, add "P" to model # (eg. **9136P-5S1**).

FNSS30	0 x 30	60	3	.10	\$40
FNSS36	0 x 36	60	3	.10	\$47
FNSS42	0 x 42	60	3	.10	\$54

FSS30	0 x 30	60	3	.10	\$51
FSS36	0 x 36	60	3	.10	\$58
FSS42	0 x 42	60	3	.10	\$64

For 9100 Series Storage Cabinets. Includes brackets.

- **FNSS** - Full width non-slotted shelf.
- **FSS** - Full width slotted shelf.

Required Specifications

Metal Finish

FILE TAXI®



File Taxi

MODEL#	DIMENSIONS	FREIGHT CLASS	WT/LBS.	CUBIC FT.	LIST PRICE
--------	------------	---------------	---------	-----------	------------

D x W x H

91-FT12L	18 x 30 x 28	100	108	11	\$886
----------	--------------	-----	-----	----	--------------

Two box drawers on right. Top box drawer includes pencil tray and divider plate. 12" legal file drawer on left with full suspension and hanging bars. Receding door with fixed shelf and 3 divider plates. One key locks all drawers. **Fits under most standard 29" h worksurfaces.** Can be used in freestanding applications. Contact customer service for a list of exceptions.



File Taxi - Mobile

91-FT12LM	18 x 30 x 29.5	100	110	12	\$1032
-----------	----------------	-----	-----	----	---------------

Two box drawers on right. Top box drawer includes pencil tray and divider plate. 12" legal file drawer on left with full suspension and hanging bars. Receding door with fixed shelf and 3 divider plates. One key locks all drawers. Wagon style handle. On casters. One key locks all drawers.

- Two 2½" fixed casters and two swivel casters.



2 High Storage Unit

9PDP30R	18 x 30 x 27.79	100	108	11	\$1100
9PDP30L	18 x 30 x 27.79	100	108	11	\$1100

Two box drawers and File drawer on top. Roll out file drawer on bottom. Not freestanding. Must be used UNDER a worksurface. Fits under most standard 29" h worksurfaces. Bolt holes are located at all four corners of top to attach to underside of worksurface. One key locks all drawers. Includes pencil tray and divider plate.

- **9PDP30R** top file drawer is on the **Right**
- **9PDP30L** top file drawer is on the **Left** (shown)

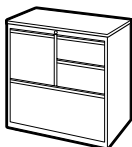

2 High Storage Unit, Freestanding

9PDP30RFSCW	18 x 30 x 27.79	85	150	11	\$1199
9PDP30LFSCW	18 x 30 x 27.79	85	150	11	\$1199

Two box drawers and File drawer on top. Roll out file drawer on bottom. Counterweight is standard. Includes pencil tray and divider plate. One key locks all drawers.

- **9PDP30RFSCW** top file drawer is on the **Right**
- **9PDP30LFSCW** top file drawer is on the **Left** (shown)

Required Specifications

Metal Finish

Accessories

Front to Back File Bars
Plate Dividers

B 1200 BOOKSHELVES

1200 SERIES BOOKSHELVES

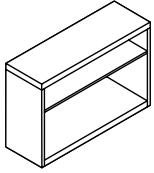

1 1/2 h Storage Cabinet - no doors

MODEL#	DIMENSIONS D x W x H	FREIGHT CLASS	WT/LBS.	CUBIC FT.	LIST PRICE
1230P1XSND	18 x 30 x 21.75	125	53	8.26	\$625
1236P1XSND	18 x 36 x 21.75	125	60	9.84	\$675
1242P1XSND	18 x 42 x 21.75	125	73.60	11.41	\$725

Half height open shelf and 12" open shelf lateral cabinet. 1 Adjustable shelf. Leveling glides included.

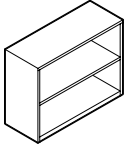

**Open Storage Cabinet - 2 high
Worksurface supporting**

1230P2SWSND	18 x 30 x 27.75	150	54.25	10.40	\$556
1236P2SWSND	18 x 36 x 27.75	150	58	12.38	\$625
1242P2SWSND	18 x 42 x 27.75	150	81	14.36	\$695

One adjustable shelf. Leveling glides included.

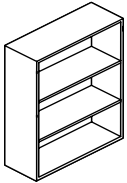

Open Storage Cabinet - 3 high

1230P3SND	18 x 30 x 40.5	250	55	14.93	\$672
1236P3SND	18 x 36 x 40.5	250	60	17.77	\$764
1242P3SND	18 x 42 x 40.5	250	70	20.62	\$857

Two adjustable shelves. Leveling glides included.

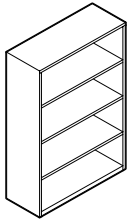

Open Storage Cabinet - 4 high

1230P4SND	18 x 30 x 54	150	90	19.73	\$834
1236P4SND	18 x 36 x 54	150	110	23.49	\$950
1242P4SND	18 x 42 x 54	150	133	27.24	\$1065

Three adjustable shelves. Leveling glides included.

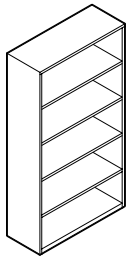

Open Storage Cabinet - 5 high

1230P5SND	18 x 30 x 65.88	150	122	23.95	\$1042
1236P5SND	18 x 36 x 65.88	150	135	28.51	\$1204
1242P5SND	18 x 42 x 65.88	150	147	33.08	\$1343

Four adjustable shelves. Leveling glides included.

Required Specifications

Metal Finish

METAL BOOKSHELVES

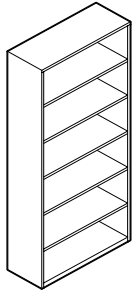

Open Storage Cabinet - 6 high

MODEL#	DIMENSIONS	FREIGHT CLASS	WT/LBS.	CUBIC FT.	LIST PRICE
--------	------------	---------------	---------	-----------	------------

D x W x H

1230P6SND	18 x 30 x 77.88	100	239	28.22	\$1320
1236P6SND	18 x 36 x 77.88	100	254	33.59	\$1482
1242P6SND	18 x 42 x 77.88	100	269	38.97	\$1644

Five adjustable shelves. Leveling glides included.

9100 SERIES BOOKSHELVES

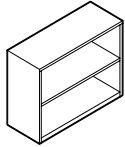

Metal Bookshelves - 28" High

91SBC2-30	13 x 30 x 28	150	40	7.84	\$201
91SBC2-36	13 x 36 x 28	150	46	9.10	\$207
91SBC2-42	13 x 42 x 28	150	49	9.10	\$274

Two high, one adjustable shelf.

- *Leveling glides not standard*

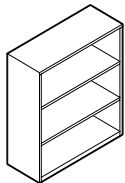

Metal Bookshelves - 41" High

91SBC3-30	13 x 30 x 41	150	53	11.21	\$218
91SBC3-36	13 x 36 x 41	150	61	13.20	\$234
91SBC3-42	13 x 42 x 41	150	66	13.20	\$299

Three high, two adjustable shelves.

- *Leveling glides not standard*

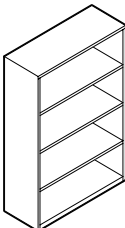

Metal Bookshelves - 53½" High

91SBC4-30	13 x 30 x 53.5	150	67	14.58	\$297
91SBC4-36	13 x 36 x 53.5	150	77	17.20	\$317
91SBC4-42	13 x 42 x 53.5	150	83	17.20	\$405

Four high, three adjustable shelves.

- *Leveling glides not standard*

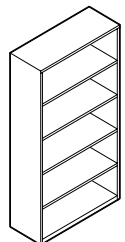

Metal Bookshelves - 66" High

91SBC5-30	13 x 30 x 66	150	81	17.95	\$392
91SBC5-36	13 x 36 x 66	150	92	21.20	\$395
91SBC5-42	13 x 42 x 66	150	99	21.20	\$528

Five high, four adjustable shelves.

- *Leveling glides not standard*

Required Specifications

Metal Finish

B 9100 BOOKSHELVES

9100 SERIES BOOKSHELVES

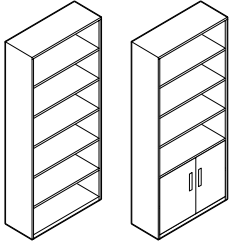

Metal Bookshelves - 79" High



Additional Shelf

MODEL#	DIMENSIONS	FREIGHT CLASS	WT/LBS.	CUBIC FT.	LIST PRICE
--------	------------	---------------	---------	-----------	------------

D x W x H

91SBC6-30	13 x 30 x 79	150	95	21.32	\$461
91SBC6-36	13 x 36 x 79	250	99	25.20	\$472
91SBC6-42	13 x 42 x 79	150	116	25.20	\$620

91SBC6D-36 (doors)	13 x 36 x 79	150	116	25.20	\$638
-----------------------	--------------	-----	-----	-------	--------------

Six high, five adjustable shelves. Model 91SBC6D-36 has four adjustable shelves with one fixed shelf above two non-locking doors.

- *Leveling glides not standard*

CBCSHLF1330	13 x 30	65	14	.50	\$86
CBCSHLF1336	13 x 36	65	14	.50	\$88
CBCSHLF1342	13 x 42	65	14	.50	\$91

For Metal Bookshelves.

Required Specifications

Metal Finish

VERTICAL FILES



Global's vertical files include a range of drawer handle options and varying drawer depths. All models are available in letter or legal size widths and a variety of color choices.

2500 Series

Features **25" deep** drawer cases and color coordinated drawer pulls, thumb latch and label holders. Two and four drawer models are available with or without lock kits and follower blocks.

2600 Series

Features **26.5" deep** drawer cases and color coordinated drawer pulls and thumb latches. Aluminum label holders. Files legal and letter size documents in 2, 3, 4 and 5 drawer heights.

2600 Plus Series

Features **26.5" deep** drawer cases and **recessed pulls** that coordinate with lateral file series. Files legal and letter size documents in 2, 3, 4 and 5 drawer heights. All models feature locking drawers.

2800 Series

Features **28" deep** drawer cases and **recessed pulls** that coordinate with lateral file series. Files legal and letter size documents in 2, 3, 4 and 5 drawer heights. All models feature three stage ball-bearing suspension and locking drawers.



Optional field installable lock kit



High drawer sides accommodate hanging folders



Features and Benefits

- Locks have removable cores for keying alike; field-installable lock kit available for non-locking models
- Full seamless closed tops for a smooth appearance and increased strength
- High wall drawer sides accommodate front-to-back hanging file folders and eliminate the need for costly hanging file frames
- Fully adjustable and removable follower block is standard
- Full extension ball-bearing suspension for smooth and durable drawer movement
- Earth friendly electrostatically applied coating protects the environment and provides a durable finish
- Available in a range of colors, including special paint finishes - see Notes for details

V VERTICAL FILES - NOTES

DESIGN & CONSTRUCTION FEATURES OF 2500 SERIES

- Cases and components are painted with a high-solids polyester and epoxy blend of powder electrostatically applied to 2 mil thickness and baked at 450° for 15 minutes to a hard and durable finish.
- **25" case depth** in both legal and letter widths. Case construction combines spot and mig welding for greater durability.
- Top cap has a seamless front giving a clean smooth appearance while increasing strength and rigidity.
- Additional strength is provided by four vertical steel channels.
- Standard warehouse product will be non-locking models.
- Field installable lock kit available for non-locking models.
- All cam locks have removable cores for keying alike or later modification in your office. Master keys and core keys are available; please contact your Global customer service representative.
- 2500 Series has **color coordinated drawer pulls, thumb latch and extra wide label holders.**
- Standard thumb latch prevents accidental drawer opening or bounce back.
- High wall drawer sides accommodate front-to-back hanging file folders.
- A follower block is standard in every drawer for holding "non-hanging" file folders upright. Removable to maximize space.
- Leveling glide option NOT available
- Full extension ball-bearing suspension provides smooth and durable drawer movement. Built-in guides for easy drawer removal and insertion to adapt to changing filing needs.
- Lifetime Warranty. (See Terms and Conditions)
- **Level 2 Certified**

DESIGN & CONSTRUCTION FEATURES OF 2600 SERIES

- Cases and components are painted with a high-solids polyester and epoxy blend of powder electrostatically applied to 2 mil thickness and baked at 450° for 15 minutes to a hard and durable finish.
- **26½" case depth** in both legal and letter widths. Case construction combines spot and mig welding for greater durability.
- Top cap has a seamless front giving a clean smooth appearance while increasing strength and rigidity.
- Additional strength is provided by four vertical steel channels.
- Standard warehouse product will be non-locking models.
- Field installable lock kit available for non-locking models.
- All cam locks have removable cores for keying alike or later modification in your office. Master keys and core keys are available; please contact your Global customer service representative.
- 2600 Series has **color coordinated drawer pulls and thumb latch. Extra wide label holder is aluminum.**
- Standard thumb latch prevents accidental drawer opening or bounce back.
- High wall drawer sides accommodate front-to-back hanging file folders.
- A follower block is standard in every drawer for holding "non-hanging" file folders upright. Removable to maximize space.
- Leveling glide option NOT available
- Full extension ball-bearing suspension provides smooth and durable drawer movement. Built-in guides for easy drawer removal and insertion to adapt to changing filing needs.
- Lifetime Warranty. (See Terms and Conditions)
- **Level 2 Certified**

DESIGN & CONSTRUCTION FEATURES OF 2800 SERIES

- Cases and components are painted with a high-solids polyester and epoxy blend of powder electrostatically applied to 2 mil thickness and baked at 450° for 15 minutes to a hard and durable finish.
- **28" case depth** in both legal and letter widths. Case construction combines spot and mig welding for greater durability.
- Fully seamless top cap gives a clean smooth appearance while increasing strength and rigidity.
- Additional strength is provided by six vertical steel channels (3 each side) in a fully enclosed welded bottom .
- **Locks are standard** on all 2800 series models.
- All cam locks have removable cores for keying alike or later modification in your office. Master keys and core keys are available; please contact your Global customer service representative.
- 2800 Series drawer fronts have **recessed drawer pulls with moveable clear label holder.**
- Interior drawer parts are painted to match the exterior. All accessories are black.
- High wall drawer sides accommodate front-to-back hanging file folders.
- A follower block is standard in every drawer for holding "non-hanging" file folders upright. Removable to maximize space.
- Leveling glides not standard
- Full extension ball-bearing suspension provides smooth and durable drawer movement. Built-in guides for easy drawer removal and insertion to adapt to changing filing needs.
- **All 2800 series models are made to order.**
- Lifetime Warranty. (See Terms and Conditions)
- **Level 2 Certified**

STANDARD PAINT FINISHES

BLK BLACK	BGR BUSINESS GREY	CGR CHARCOAL	DPT DESERT PUTTY	GRY GREY
LGR LIGHT GREY	NEV NEVADA	SGR STORM GREY	TSA TAHITI SAND	

SPECIAL PAINT FINISHES

- **All special colors must use ONE uniform color per series (example: 9300 series laterals). Quantities of 1 to 10 add 10%; 11 or more are NO UPCHARGE.**
- **Mica and Metallic finishes add 10% upcharge.**
- **Special white finishes add 10% upcharge.**
- **ALL NONSTANDARD FINISHES MUST BE APPROVED BY GLOBAL BEFORE ANY ORDER WILL BE ACCEPTED. LONGER LEAD TIMES WILL APPLY.**
- **Thumb latches and handles limited to colors listed above. You must choose closest or contrasting color at the time of order.**
- **Drawer pulls are only available in the standard paint finish colors**

2500 SERIES



2 Drawer Vertical File - Letter

MODEL#	DIMENSIONS	FREIGHT CLASS	WT/LBS.	CUBIC FT.	LIST PRICE
--------	------------	---------------	---------	-----------	------------

D x W x H

25-200	25 x 15.15 x 29	125	62	9	\$261
25-201	25 x 15.15 x 29	125	62	9	\$275
25-200NF	25 x 15.15 x 29	125	62	9	\$255

25" deep, files letter size documents. Color coordinated drawer pulls and thumb latch.

- **Lock included on model 25-201.**
- NF models do NOT have a follower block. See FBL-2 pricing below.



2 Drawer Vertical File - Legal

25-250	25 x 18.1875 x 29	125	67	11	\$306
25-251	25 x 18.1875 x 29	125	67	11	\$319
25-250NF	25 x 18.1875 x 29	125	67	11	\$290

25" deep, files legal size documents. Color coordinated drawer pulls and thumb latch.

- **Lock included on model 25-251.**
- NF models do NOT have a follower block. See FBL-2 pricing below.



4 Drawer Vertical File - Letter

25-400	25 x 15.15 x 52	125	112	16	\$350
25-401	25 x 15.15 x 52	125	112	16	\$363
25-400NF	25 x 15.15 x 52	125	112	16	\$327

25" deep, files letter size documents. Color coordinated drawer pulls and thumb latch.

- **Lock included on model 25-401.**
- NF models do NOT have a follower block. See FBL-2 pricing below.



4 Drawer Vertical File - Legal

25-450	25 x 18.1875 x 52	125	122	19	\$402
25-451	25 x 18.1875 x 52	125	122	19	\$415
25-450NF	25 x 18.1875 x 52	125	122	19	\$379

25" deep, files legal size documents. Color coordinated drawer pulls and thumb latch.

- **Lock included on model 25-451.**
- NF models do NOT have a follower block. See FBL-2 pricing below.



5 Drawer Vertical File - Letter

25-500	25 x 15.15 x 64.25	125	123	19.50	\$514
25-501	25 x 15.15 x 64.25	125	123	19.50	\$529

25" deep, files letter size documents. Color coordinated drawer pulls and thumb latch.

- **Lock included on model 25-501.**

Required Specifications

Metal Finish

Optional Specifications

Lock

V VERTICAL FILES

2500 SERIES



5 Drawer Vertical File - Legal

MODEL#	DIMENSIONS	FREIGHT CLASS	WT/LBS.	CUBIC FT.	LIST PRICE
	D x W x H				
25-550	25 x 18.1875 x 64.25	150	130	22.80	\$536
25-551	25 x 18.1875 x 64.25	150	130	22.80	\$544

25" deep, files legal size documents. Color coordinated drawer pulls and thumb latch.

- **Lock included on model 25-551.**

2600 SERIES



2 Drawer Vertical File

26-200	26.56 x 15.15 x 29	125	65	10	\$290
26-201	26.56 x 15.15 x 29	125	65	10	\$306
26-250	26.56 x 18.1875 x 29	150	70	12	\$350
26-251	26.56 x 18.1875 x 29	150	70	12	\$363

26 9/16" deep. Color coordinated drawer pulls and thumb latch. Aluminum label holder.

- **26-200 & 26-201** file letter size documents; **26-250 & 26-251** file legal size documents.

- **Lock included on models 26-201 & 26-251.**

- Interlock safety mechanism available only on locking models. Please see notes on page 742.



3 Drawer Vertical File

26-300	26.56 x 15.15 x 40	125	92	13	\$379
26-301	26.56 x 15.15 x 40	125	92	13	\$395
26-350	26.56 x 18.1875 x 40	125	104	16	\$438
26-351	26.56 x 18.1875 x 40	125	104	16	\$454

26 9/16" deep. Color coordinated drawer pulls and thumb latch. Aluminum label holder.

- **26-300 & 26-301** file letter size documents; **26-350 & 26-351** file legal size documents.

- **Lock included on models 26-301 & 26-351.**

- Interlock safety mechanism available only on locking models. Please see notes on page 742.

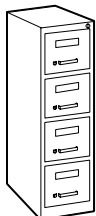

4 Drawer Vertical File

26-400	26.56 x 15.15 x 52	125	118	17	\$402
26-401	26.56 x 15.15 x 52	125	118	17	\$415
26-450	26.56 x 18.1875 x 52	125	128	20	\$468
26-451	26.56 x 18.1875 x 52	125	128	20	\$481

26 9/16" deep. Color coordinated drawer pulls and thumb latch. Aluminum label holder.

- **26-400 & 26-401** file letter size documents; **26-450 & 26-451** file legal size documents.

- **Lock included on models 26-401 & 26-451.**

- Interlock safety mechanism available only on locking models. Please see notes on page 742.



5 Drawer Vertical File

26-500	26.56 x 15.15 x 64.25	125	141	21	\$586
26-501	26.56 x 15.15 x 64.25	125	141	21	\$600
26-550	26.56 x 18.1875 x 64.25	125	157	24	\$674
26-551	26.56 x 18.1875 x 64.25	125	157	24	\$688

26 9/16" deep. Color coordinated drawer pulls and thumb latch. Aluminum label holder.

- **26-500 & 26-501** file letter size documents; **26-550 & 26-551** file legal size documents.

- **Lock included on models 26-501 & 26-551.**

- Interlock safety mechanism available only on locking models. Please see notes on page 742.

Required Specifications

Metal Finish

Optional Specifications

Lock

2600 PLUS SERIES (RECESSED PULLS)

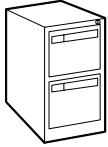

2 Drawer Vertical File

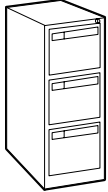

3 Drawer Vertical File

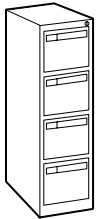

4 Drawer Vertical File

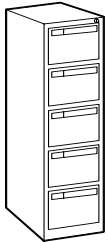

5 Drawer Vertical File

MODEL#	DIMENSIONS	FREIGHT CLASS	WT/LBS.	CUBIC FT.	LIST PRICE
--------	------------	---------------	---------	-----------	------------

D x W x H

26-202	26.56 x 15.15 x 29	125	65	10	\$335
26-252	26.56 x 18.15 x 29	150	70	12	\$401

26 9/16" deep with recessed pulls. No thumb latch. Lock included. Ball-bearing suspension.
 • **26-202** files letter size documents; **26-252** files legal size documents.

26-302	26.56 x 15.15 x 40	125	92	13	\$433
26-352	26.56 x 18.15 x 40	125	104	16	\$482

26 9/16" deep with recessed pulls. No thumb latch. Lock included. Ball-bearing suspension.
 • **26-302** files letter size documents; **26-352** files legal size documents.

26-402	26.56 x 15.15 x 52	125	118	17	\$458
26-452	26.56 x 18.15 x 52	125	128	20	\$528

26 9/16" deep with recessed pulls. No thumb latch. Lock included. Ball-bearing suspension.
 • **26-402** files letter size documents; **26-452** files legal size documents.

26-502	26.56 x 15.15 x 64.25	125	141	21	\$659
26-552	26.56 x 18.15 x 64.25	125	157	24	\$758

26 9/16" deep with recessed pulls. No thumb latch. Lock included. Ball-bearing suspension.
 • **26-502** files letter size documents; **26-552** files legal size documents.

ACCESSORIES FOR ALL VERTICAL FILES



Lock Kit

LK26	--	70	--	--	\$16
LK26-50	--	60	--	--	\$645

Field installable kit for 2500 and 2600 Series.
 • *50 kits to a carton for 2500 and 2600 Series.*

Follower Block

FBL-2	--	--	--	--	\$16
-------	----	----	----	----	-------------

2 pack. For 2500 and 2600 Series only.



Extra Key

EK93	--	70	--	--	\$10
------	----	----	----	----	-------------

Specify core #. Key range W401-W550.

Required Specifications

Metal Finish

Optional Specifications

Lock

V VERTICAL FILES

ACCESSORIES FOR ALL VERTICAL FILES



Touch Up Paint

MODEL#	DIMENSIONS D x W x H	FREIGHT CLASS	WT/LBS.	CUBIC FT.	LIST PRICE
PB-COLOR	--	--	--	--	\$24

½ oz. paint bottle with brush. Order by standard color codes

Interlock Safety Mechanism

LI	--	--	--	--	\$22
----	----	----	----	----	-------------

For 2600 and 2800 Series. Allows only one drawer to be opened at a time.

- Pricing shown is for one drawer.
- Available on 2600 and 2800 series **locking** models only.

2800 SERIES

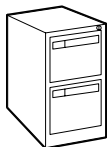

2 Drawer Vertical File

28-202	28 x 15 x 28	92.5	82	8	\$473
28-252	28 x 18 x 28	100	90	10	\$517

28" deep with recessed pulls. **No thumb latch.** Lock included. Three stage ball-bearing suspension.

- **28-202** files letter size documents; **28-252** files legal size documents.

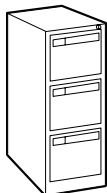

3 Drawer Vertical File

28-302	28 x 15 x 40.37	100	116	13	\$620
28-352	28 x 18 x 40.37	125	127	16	\$664

28" deep with recessed pulls. **No thumb latch.** Lock included. Three stage ball-bearing suspension.

- **28-302** files letter size documents; **28-352** files legal size documents.

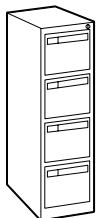

4 Drawer Vertical File

28-402	28 x 15 x 52.25	100	151	16	\$723
28-452	28 x 18 x 52.25	100	167	18	\$768

28" deep with recessed pulls. **No thumb latch.** Lock included. Three stage ball-bearing suspension.

- **28-402** files letter size documents; **28-452** files legal size documents.

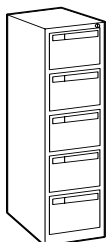

5 Drawer Vertical File

28-502	28 x 15 x 62.75	100	186	21	\$871
28-552	28 x 18 x 62.75	100	200	23	\$915

28" deep with recessed pulls. **No thumb latch.** Lock included. Three stage ball-bearing suspension.

- **28-502** files letter size documents; **28-552** files legal size documents.

Required Specifications

Metal Finish

BLOCKS FILES



Global's new **BLOCKS** filing system allows for two-sided file access which can be used in a variety of applications. BLOCKS are stackable and easy to configure. Simply choose a Lower Block and Upper Block to create a unique configuration. In conjunction with worksurfaces, Blocks creates functional and space-efficient work spaces.

A variety of drawer options are available to create a truly unique filing configuration. Lower units are offered in two and three-high fixed front units. Middle Blocks function as alignment windows in standard or binder heights. Upper Blocks are offered in one, two and three high in several configurations: receding drawers, fixed front drawers, double doors, shelves and storage cabinets. Blocks are quick and easy to set up, configure and if needed, reconfigure.



Features and Benefits

- Provides multi-user solutions with access from either side of the files
- Standard 12" high openings
- Top of each Block has a stiffener bar
- Top corners have corner gussets for extra rigidity
- Drawer fronts feature looped full pulls
- Constructed from cold rolled steel
- Middle Blocks are open to create a pass through
- Counterweights and levelling glides are standard on Lower Blocks
- Upper Blocks always open in the opposite direction of Lower Blocks
- Optional Laminate tops available in all Global laminate finishes
- Electronic locks are available
- Available in all standard and premium file finishes
- Total cabinet height cannot exceed 6 high



Electronic Lock (optional)



Looped full pull handles (standard)



Full extension ball bearing suspension on drawers (standard)

GENERAL INFORMATION

- Stackable Filing System that can be easily assembled and reconfigured on site
- Provides multi-user solutions with access from two sides of files
- An assortment of cabinet openings and heights are available to create a wide variety of file configurations
- Global filing products are in compliance with stringent emission guidelines set out by the Greenguard Environmental Institute under the standards for low emitting products and materials. www.greenguard.org
- Level 2 Certified

BUILDING THE CABINET

- Select a Lower Block
- Select an Upper Block
- Join Blocks to create a file cabinet with access from 2 sides
- Upper Block cabinet always opens in the opposite direction of the Lower Block cabinet.
- Blocks are assembled quickly and easily using 4 bolts and the Blocks supplied wrench

CONSTRUCTION

- Each Block is constructed from prime cold rolled commercial quality steel
- All Blocks are 36" wide and 18" deep. 12" high openings are standard
- All fronts have looped full pulls
- For extra strength, the top of each Upper Block has a stiffener bar
- Fixed front drawers and receding doors include stiffener bar for extra strength
- Leveling glides on Lower Blocks allow for proper leveling
- Counterweight is standard on Lower Blocks
- Total cabinet height CANNOT exceed 6 high

MODESTY PANELS

- Standard on desks, returns and bridges.
- Recessed 4" deep on 24"d desks, 5" deep on 30"d desks and 6" deep on 36"d desks.
- Flush on Freestanding Returns.
- Recessed 4" on 24" d, 5" deep on 30" d, and 6" deep on 36"d Flush and Overlapping Returns.
- Recessed 4" on 24" deep and 5" deep on 30" deep Flush and Overlapping Bridges
- Desks and returns feature modesty panel that is flush with end panel
- Bottom of modesty panel is 17 3/4" from floor.

CONFIGURATIONS

- **F** - 12" Fixed Front Roll-out drawers
- **S** - 12" Receding Door and Fixed Shelf
- **R** - 12" Receding Door and Roll-out Shelf
- **W** - 12" Window or Binder Pass-thru
- **ND** - 12" Open Shelf
- **DD** - 12" Double Door Storage

LOCKS

- Key lock is standard on Upper and Lower Blocks
- Upper Block lock location is on lower rail and Lower Block lock location is on upper rail to meet ADA Standards

E-LOCK (OPTIONAL)

- E-Lock keyless entry system is available on Upper and Lower Blocks. **Order as EL. ADD 250.00**
- Personalized entry code set by user
- Allows for multiple entry codes to accommodate multiple users
- Online entry code registration and retrieval

OPTIONS

- Plate dividers, front to back filing bars and extra keys
- Can be keyed alike upon request.

SHIPPING

- Each Block is packaged separately and ready to configure with other Blocks

FINISHES

Standard Paint Finishes

BLK	Black	BGR	Business Grey
CGR	Charcoal	DPT	Desert Putty
GRY	Grey	LGR	Light Grey
SGR	Storm Grey	NEV	Nevada
TSA	Tahiti Sand		

Premium Paint Finishes (extended lead time)

F29	Bone	F09	Claret
F23	Cloud	DWT	Designer White
F33	Ice	F30	Ivory
F07	Metro	F05	Moss
F19	Navy	F35	Oyster
F32	Stone	TU2	Tungsten 2
F28	Willow		

Textured Paint Finishes

U04	Black Coffee
T19	Dark Chocolate
T20	Cappuccino
J52	Mocha
J23	Vanilla

CUSTOM PAINT FINISHES

- A 10% upcharge will be applied on quantities of 1 to 10; 11 or more are NO UPCHARGE.
- **White, Mica and Metallic finishes can be applied at 10% upcharge.**
- **ALL NONSTANDARD FINISHES MUST BE APPROVED BY GLOBAL BEFORE ANY ORDER WILL BE ACCEPTED. LONGER LEAD TIMES WILL APPLY.**

LAMINATE TOPS

- Laminate tops are available in 36" wide and 18" deep only.
- Tops are 1 1/8" thick, constructed in 45 pound density particle board covered on both sides with thermally fused laminate
- Available in all standard Global laminate finishes

UPPER BLOCKS

1 high

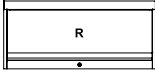

BU36P1R

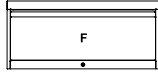

BU36P1F

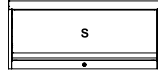

BU36P1S

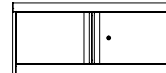

BU36P1DD

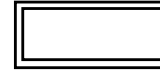

BU36P1ND

2 High

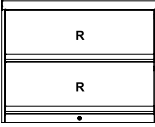

BU36P2RR

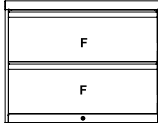

BU36P2FF



BU36P2RF

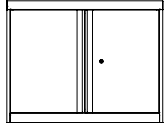

BU36P2DD



BU36P2ND

3 High

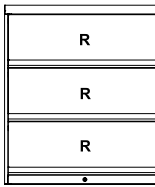

BU36P3RRR

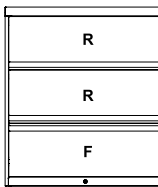

BU36P3RRF

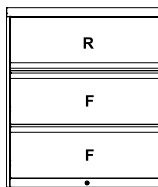

BU36P3RFF

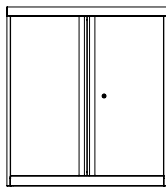

BU36P3DD



BU36P3ND

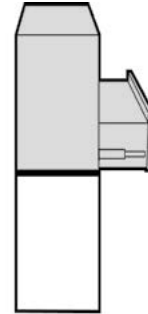

MIDDLE BLOCKS

Alignment window pass-thru unit



BM36AW

Binder height window pass-thru unit



BM36BW

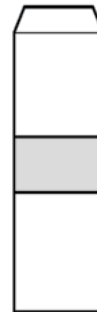

LOWER BLOCKS

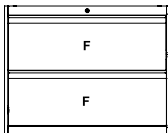

BL36P2FF

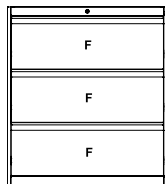

BL36P3FFF

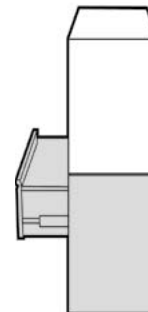

LEGEND

F - Fixed Front - Roll out drawers

R - Receding Door with Roll-out shelf

S - Receding Door with Fixed shelf

DD - Double Door Storage

ND - Open Shelf

W - Window/Binder Pass-thru

NOTE: Maximum height allowed is 6 high. Anything higher becomes unstable.

B BLOCKS FILES

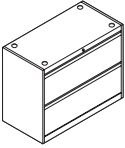
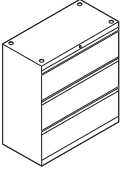
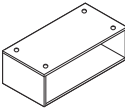
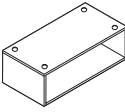
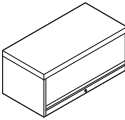
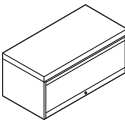
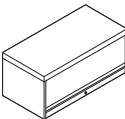
BLOCKS	MODEL#	DIMENSIONS D x W x H	FREIGHT CLASS	WT/LBS.	CUBIC FT.	LIST PRICE
	BL36P2FF	18 x 36 x 28.37	92.5	142	12.60	\$1002
Lower Block - Two-High	Two fixed fronts drawers. 12" openings. Side to side hanging file bars included. Lock and counterweight are standard. • <i>File cannot be used to store standard three ring binders.</i>					
	BL36P3FFF	18 x 36 x 40.37	125	128	17.70	\$1265
Lower Block - Three-High	Three fixed fronts drawers. 12" openings. Side to side hanging file bars included. Lock and counterweight are standard. • <i>File cannot be used to store standard three ring binders.</i>					
	BM36AW	18 x 36 x 12.12	150	36	7.50	\$444
Middle Block	Alignment window pass-through. Attaches between top and bottom units. • <i>File cannot be used to store standard three ring binders.</i>					
	BM36BW	18 x 36 x 14.12	150	38	8	\$490
Middle Block - Binder Height	Alignment window pass-through. Attaches between top and bottom units.					
	BU36P1R	18 x 36 x 16.12	100	62	7.50	\$749
Upper Block - One-High	Receding door and roll-out shelf. 12" opening. Side to side hanging file bars included. Lock on lower rail of unit. • <i>File cannot be used to store standard three ring binders.</i>					
	BU36P1F	18 x 36 x 16.12	125	57	7.50	\$717
Upper Block - One-High	Fixed front drawer. 12" opening. Side to side hanging file bars included. Lock on lower rail of unit. • <i>File cannot be used to store standard three ring binders.</i>					
	BU36P1S	18 x 36 x 16.12	125	59	7.50	\$717
Upper Block - One-High	Receding door and fixed shelf. 12" opening. Side to side hanging file bars included. Lock on lower rail of unit. • <i>File cannot be used to store standard three ring binders.</i>					

Required Specifications
Metal Finish

Optional Specifications
Electronic Lock

Accessories
Front to Back File Bars
Plate Dividers

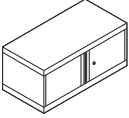
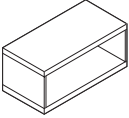
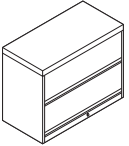
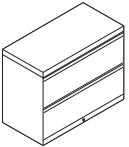
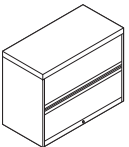
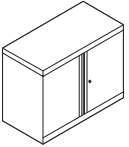
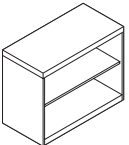
BLOCKS	MODEL#	DIMENSIONS D x W x H	FREIGHT CLASS	WT/LBS.	CUBIC FT.	LIST PRICE
 Upper Block - One-High	BU36P1DD	18 x 36 x 16.12	125	54	7.50	\$432
						Storage cabinet with double doors. Lock included. <ul style="list-style-type: none"> • File cannot be used to store standard three ring binders.
 Upper Block - One-High	BU36P1ND	18 x 36 x 16.12	150	36	7.50	\$351
						Open shelf. <ul style="list-style-type: none"> • File cannot be used to store standard three ring binders.
 Upper Block - Two-High	BU36P2RR	18 x 36 x 28.12	100	102	12.50	\$882
						Two receding doors and roll-out shelves. 12" openings. Side to side hanging file bars included. Lock on lower rail of unit. <ul style="list-style-type: none"> • File cannot be used to store standard three ring binders.
 Upper Block - Two-High	BU36P2FF	18 x 36 x 28.12	125	91	12.50	\$831
						Two fixed front drawers. 12" openings. Side to side hanging file bars included. Lock on lower rail of unit. <ul style="list-style-type: none"> • File cannot be used to store standard three ring binders.
 Upper Block - Two-High	BU36P2RF	18 x 36 x 28.12	125	96	12.50	\$856
						1 Receding door and roll-out shelf, 1 fixed front drawer. 12" openings. Side to side hanging file bars included. Lock on lower rail of unit. <ul style="list-style-type: none"> • File cannot be used to store standard three ring binders.
 Upper Block - Two-High	BU36P2DD	18 x 36 x 28.12	125	82	12.50	\$509
						Storage cabinet with double doors. Lock included.
 Upper Block - Two-High	BU36P2ND	18 x 36 x 28.12	150	74	12.50	\$413
						Two open shelves.

Required Specifications
Metal Finish

Optional Specifications
Electronic Lock

Accessories
Front to Back File Bars
Plate Dividers

B BLOCKS FILES

BLOCKS	MODEL#	DIMENSIONS D x W x H	FREIGHT CLASS	WT/LBS.	CUBIC FT.	LIST PRICE
--------	--------	-------------------------	---------------	---------	-----------	------------

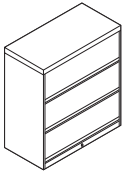

Upper Block - Three-High

BU36P3RRR	18 x 36 x 40.12	100	141	17.60	\$1182
-----------	-----------------	-----	-----	-------	---------------

Three receding doors and roll-out shelves. 12" openings. Side to side hanging file bars included. Lock on lower rail of unit.
 • *File cannot be used to store standard three ring binders.*

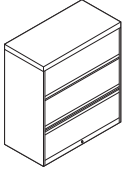

Upper Block - Three-High

BU36P3RFF	18 x 36 x 40.12	125	128	17.60	\$1162
-----------	-----------------	-----	-----	-------	---------------

Two receding doors and roll-out shelves, 1 fixed front drawer. 12" openings. Side to side hanging file bars included. Lock on lower rail of unit.
 • *File cannot be used to store standard three ring binders.*

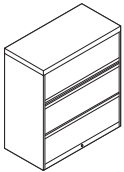

Upper Block - Three-High

BU36P3RFF	18 x 36 x 40.12	125	130	17.60	\$1136
-----------	-----------------	-----	-----	-------	---------------

1 receding door and roll-out shelves, Two fixed front drawers. 12" openings. Side to side hanging file bars included. Lock on lower rail of unit.
 • *File cannot be used to store standard three ring binders.*

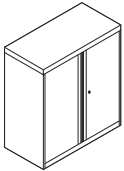

Upper Block - Three-High

BU36P3DD	18 x 36 x 40.12	125	121	17.60	\$668
----------	-----------------	-----	-----	-------	--------------

Storage cabinet with double doors. Lock included.

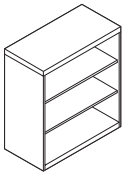

Upper Block - Three-High

BU36P3ND	18 x 36 x 40.12	150	102	17.60	\$574
----------	-----------------	-----	-----	-------	--------------

Three open shelves.

Required Specifications
Metal Finish

Optional Specifications
Electronic Lock

Accessories
Front to Back File Bars
Plate Dividers

textiles and finishes

Care and Cleaning

Textiles

Fabrics: To extend the life of your seating upholstered in fabric, regularly dust the chair to prevent airborne particles from penetrating the fabric surface.

For light soiling, use a damp cloth and blot the spot with very slight pressure, taking care never to soak the fabric. Dry with a clean cloth by blotting - never rub fabric. More intense stains can be treated the same way, but with a mild detergent. Always test fabric first in an unseen area before using any cleaning method.

Leather: For regular cleaning, simply use a soft damp cloth, taking care not to soak the leather. For more thorough treatment, soak a soft cloth in mild soap solution and wipe surface in a light circular motion. Repeat with clean water. Allow to dry and polish with a soft dry cloth. Do not use detergents, aerosol sprays or other polishes.

Hard Surfaces

Wood Veneer Finishes: Waxing or polishing catalyzed finishes is not recommended because this will give a greasy, cloudy or uneven appearance to the product and could void your warranty. Global's conversion varnish is best cleaned by wiping the surface with a damp cloth, followed by a soft dry cloth in the direction of the grain. If the surfaces are heavily soiled, a gentle product like "Windex" can be used, following the same instructions as above.

Laminate & Painted Metal Finishes: Using a soft cloth, simply wipe the surface with a mild soap solution or glass cleaner. Always use a dry cloth and circular motion to prevent streaks.

-
- **Water-Based Cleaner:** Spot clean, using the foam only from a water-based cleaning agent, such as a mild detergent or non-solvent upholstery shampoo product. Apply foam with a soft brush in a circular motion. Vacuum when dry. Pretest small area before proceeding.
 - **Solvent Cleaner:** Spot clean, using a mild water-free solvent or dry cleaning product. Clean only in a well-ventilated room and avoid any product containing carbon tetrachloride or other toxic materials. Pretest a small area before proceeding.
 - **Water/Solvent Cleaner:** Spot clean with a mild solvent, an upholstery shampoo, or the foam from a mild detergent. When using a solvent or dry cleaning product, follow instructions carefully and clean only in a well-ventilated room. Avoid any product that contains carbon tetrachloride or other toxic materials. With either method, pretest a small area before proceeding.
 - **Vacuum Only:** Clean this fabric only by vacuuming or light brushing to prevent accumulation of dust and grime. Water-based foam cleaning agents of any kind may cause excessive shrinking, staining, or distortion of the surface pile and therefore, should not be used.
 - **Crypton Cleaning:** Generally stains are removed with plain water and powdered enzyme detergent. Upholstery foam shampoo, water-based cleaning products and germicidal detergents can be used. Be sure to remove all residue from cleaning products with clean water. Do not use solvent-based cleaners or dry cleaning products.
 - These recommendations and codes were developed by fabric specialists. However, because of the various ways fabric can be stained or damaged, there is no guarantee that the results will be completely successful. Use suggested methods on your own responsibility. To help prevent overall soil, frequent vacuuming or light brushing to remove dust and grime is recommended. Use professional furniture cleaning service when overall soiled condition has been reached.

TEXTILES & FINISHES

Textile Price Grades - Global Textiles

Grade 1	Drama, Hudson, Jenny, Mock Leather, Pebbles, Quilt, Sprinkle, Station, Terrace, Urban, Waterfall
Grade 2	Allante, Crescent, Cumulus, Imprint, Match, Oxygen, Quantum, Renewal, Replay, Silhouette
Grade 3	Couture
Grade 4	Non standard GLOBAL textiles
Grade 5	Leather/Mock Leather combination
Grade 6	Non standard GLOBAL textiles
Grade 7	Non standard GLOBAL textiles
Grade 8	Genuine Leather, Non standard GLOBAL textiles
Grade 9	Non standard GLOBAL textiles
Grade 11	Non standard GLOBAL textiles
Grade 10	Non standard GLOBAL textiles
Grade 12	Non standard GLOBAL textiles

Please refer to individual seating series for availability of a particular textile.

The charts above do not include Textiles offered by Alliance Partners: Arc-Com Fabrics, CF Stinson, Designtex, Knoll Textiles, Green Hides, LDI, Luum Textiles, Maharam, Mayer Fabrics, Momentum, and Ultrafabrics.

Blend Seating Textiles

The grid below outlines the grade structure for using multiple textiles on select seating series. Blended textiles occur when one textile is chosen for one part of the chair and a different textile is selected for another part of the chair, resulting in a revised blended grade. For opportunities regarding more than two different textiles, please contact Global CustomerCare for approval process and grading.

FIRST TEXTILE SELECTED

		1	2	3	4	5	6	7	8	9	10	11	12	13	14	15	16	17	18
SECOND TEXTILE SELECTED	1	1																	
	2	2	2																
	3	3	3	3															
	4	3	4	4	4														
	5	4	4	5	5	5													
	6	5	5	5	6	6	6												
	7	5	6	6	6	7	7	7											
	8	6	6	7	7	7	8	8	8										
	9	7	7	7	8	8	8	9	9	9									
	10	8	8	8	8	9	9	9	10	10	10								
	11	9	9	9	9	9	10	10	10	11	11	11							
	12	10	10	10	10	10	10	11	11	11	12	12	12						
	13	11	11	11	11	11	11	12	12	12	12	13	13	13					
	14	11	12	12	12	12	12	12	13	13	13	13	14	14	14				
	15	12	12	13	13	13	13	13	13	14	14	14	14	15	15	15			
	16	13	13	13	14	14	14	14	14	14	15	15	15	15	16	16	16		
	17	14	14	14	14	15	15	15	15	15	15	16	16	16	16	17	17	17	
	18	15	15	15	15	15	16	16	16	16	16	16	17	17	17	17	18	18	18

Textile and Color Listings

Grade 1

Drama 65% Olefin / 35% Polyester

D801 Grey	D802 Dusk	D803 Navy Blue	D804 Black	D805 Burgundy	D806 Sage	D807 Beige
D808 Denim Blue	D809 Wheat	D810 Tan				

Hudson 100% Post-Consumer Recycled Polyester

HD02 Cordovan	HD03 Ruby	HD04 Orange	HD05 Wheat	HD06 Meadow	HD07 Coffee	HD08 Grey
HD09 Mocha	HD10 Thyme	HD11 Carbon	HD12 Midnight	HD13 Ocean	HD14 Cerulean	

Jenny 100% Polyester

JN01 Midnite	JN02 Ebony	JN03 Slate	JN04 Russet	JN05 Canyon	JN06 Teal	JN07 Vermilion
JN08 Admiral	JN09 Spruce	JN11 Charcoal				

Mock Leather 100% Polyvinyl Chloride

550 Black	559 Chamois	570 Surf	571 Latte	572 Melon	573 Delta	576 Jade
574 Bronze	575 Rouge	577 Graphite	578 Chaps	579 Cabernet	591 Alpine	

Pebbles 100% Polypropylene

PB01 Clay	PB02 Fawn	PB03 Sea Side	PB04 Stone	PB05 Marine	PB06 Atrium	PB07 Rhapsody
PB08 Ocean	PB09 Asphalt					

Quilt 100% Polyester

QL10 Black	QL11 Charcoal Grey	QL12 Violet	QL13 Poppy	QL14 Navy	QL15 Marine	QL16 Wine
QL17 Mint	QL18 Forrest	QL19 Silver				

Sprinkle 68% Olefin / 32% Polyester

S101 Cabernet	S102 Plum	S103 Barley	S104 Copper	S106 Sapphire	S107 Jade	S108 Stone
S109 Cobalt	S110 Black	S111 Graphite				

Station 61% Recycled Polyester / 39% Polypropylene

SN81 Green Olive	SN82 Sterling Silver	SN83 New Silver	SN84 Wheat	SN85 Sand	SN86 Sapphire	SN87 Tomato
SN88 Copper	SN89 Marine	SN90 Night Time	SN91 Charcoal	SN92 Taupe	SN93 Milk Chocolate	

Terrace 70% Virgin Polyester / 30% Post-Consumer Recycled Polyester

TC60 Lotus	TC61 Tigerlily	TC62 Shadow	TC63 Cobble	TC64 Cherry Blossom	TC65 Bluebell	TC66 Apple
TC67 Haze	TC68 Cerise	TC69 Twilight	TC70 Wintergreen	TC71 Ironwork	TC72 Pine Cone	TC73 Flirt
TC74 Echo						

Urban 62% Recycled Polyester / 32% Polyester

UR10 Red Rose	UR11 Ocean Blue	UR12 Blue Bayou	UR13 Green Grass	UR14 Sandcastle	UR15 Beach Day	UR16 Boardwalk
UR17 Earth	UR18 Brown Ridge	UR19 White Sand	UR20 Granite Rock	UR21 Gravel Road	UR22 Black Coal	

Waterfall 60% Virgin Polyester / 40% Post-Consumer Recycled Polyester

WA40 Trance	WA41 Tryst	WA42 Splash	WA43 Victoria	WA44 Imagine	WA45 Sky	WA46 Rainforest
WA47 Rumble	WA48 Prism	WA49 Tranquility	WA50 Grand	WA51 Rushing	WA52 Magestic	WA53 Pacific
WA54 Dance						

Grade 2

Crescent 100% Nylon with Teflon Designed to color coordinate with Renewal and Quantum fabrics.

700 Cocoa	701 Pear	702 Silver	703 Oatmeal	704 Lemon	705 Flame	706 Stem
709 Ruby	789 Raven	790 Cobalt Blue	792 Cinder Grey	799 Pine	800 Arctic	

Cumulus 60% Recycled Polyester / 40% Rayon with Teflon Designed to color coordinate with Oxygen and Silhouette fabrics.

CU80 Cinnamon	CU81 Sepia	CU82 Ginger	CU83 Steamboat	CU84 Coffee	CU85 Flora	CU86 Raven
CU87 Cyan	CU88 Foliage	CU89 Port				

Imprint 100% Post-Consumer Polyester

IM70 Almond	IM71 Cork	IM72 Sand	IM73 Currie	IM74 Candy Apple	IM75 Ocean	IM76 Navy
IM78 Celery	IM77 Green Tea	IM79 Oregano	IM80 Walnut	IM81 Paprika	IM82 Graphite	IM83 Slate
IM84 Licorice						

Match 100% Recycled Polyester

MT20 Desert	MT21 Sand	MT22 Moss	MT23 Orange	MT24 Sunset	MT25 Blue	MT26 Wave
MT27 Green	MT28 Chocolate	MT29 Burgundy	MT30 Grey	MT31 Quarry	MT32 Black	MT33 Arctic

TEXTILES & FINISHES

Grade 2 (continued)

Oxygen 60% Recycled Polyester / 40% Rayon with Teflon Designed to color coordinate with Cumulus and Silhouette fabrics.

OX01 Cabernet	OX02 Lime	OX03 Verde	OX04 Navy	OX05 Royal	OX06 Chestnut	OX07 Wine
OX08 Nutmeg	OX09 Sable	OX10 Nero				

Quantum 60% Recycled Polyester / 40% Rayon with Teflon Designed to color coordinate with Crescent and Renewal fabrics.

QU20 Cinder	QU21 Copper	QU22 Carmel	QU23 Cantaloupe	QU24 Paprika	QU25 Blue Haven	QU26 Forest
QU27 Raspberry	QU28 Azure	QU29 Marbles				

Renewal 70% Nylon / 30% Recycled Polyester with Teflon Designed to color coordinate with Crescent and Quantum fabrics.

RN30 Pewter	RN31 Cork	RN32 Cherry Fields	RN33 Volcanic Ash	RN34 Thunderstorm	RN36 Blue Grass	RN38 Leaf
RN39 Melon	RN40 Blueberry	RN41 Blue Bayou	RN44 Tomato	RN45 Amethyst	RN47 Ochre	

Replay 100% Post-Consumer Recycled Polyester

RP20 Taupe	RP21 Caramel	RP22 Paprika	RP23 Wine	RP24 Ocean	RP25 Navy	RP26 Pistachio
RP27 Moss	RP28 Turquoise	RP29 Teal	RP30 Autumn	RP31 Dark Chocolate	RP32 Slate	RP33 Dove
RP34 Coal						

Silhouette 100% Nylon with Teflon Designed to color coordinate with Cumulus and Oxygen fabrics.

SL20 Asphalt	SL21 Acorn	SL22 Indigo	SL23 Shiraz	SL24 Verdant	SL25 Bronze	SL26 Camel
SL27 Jade	SL28 Sienna	SL30 Charcoal	SL32 Claret	SL35 Hunter	SL36 Sapphire	

Grade 2 (Vinyl) *For availability of chair series in Vinyl, please contact a Global Sales Representative.*

Allante 100% Vinyl Face / 100% Polyester Backing

A01E Cadet	A02E Light Neutral	A03E Charcoal	A11E Regimental Blue	A13E Galaxy	A17E Burgundy	A18E Wine
A19E Nu-Red	A21E Elephant	A22E Cinnamon	A23E Beach Wood	A24E Teak	A25E Light Sand	A26E Cream
A27E Medium Beige	A29E Light Sandlewood	A31E Light Parchment	A32E Sea Oyster	A33E Espresso	A35E Medium Neutral	A36E Nu-Antelope
A38E Dark Pewter	A40E Nu-Shale	A41E Grey	A42E Bisque	A43E Black	A44E Ash	A45E Medium Grey
A46E Pearl Grey	A48E White	A49E Tundra	A50E Harvest	A51E Magnolia	A52E River Blue	A53E Meadow
A54E Hideaway	A55E Sea Cruise	A56E Reef	A57E Parrot	A58E Khaki	A50E Tumbleweed	A60E Cayenne
A61E Butterscotch	A62E Twine	A63E Mango				

Grade 2 (Recycled)

Couture 100% Post-Consumer Polyester

CE70 Champagne	CE71 Mocha	CE72 Pecan	CE73 Raspberry	CE74 Sapphire	CE75 Neptune	CE76 Lake
CE77 Willow	CE78 Sassy	CE79 Fudge	CE80 Persimmon	CE81 Carbon	CE82 Sterling	CE83 Peat

Grade 5

Genuine Leather/Mock Leather combinations 100% Leather / 100% Polyvinyl Chloride

450/550 Black	459/559 Chamois	470/570 Surf	471/571 Latte	472/572 Melon	473/573 Delta	474/574 Bronze
475/575 Rouge	476/576 Jade	477/577 Graphite	478/578 Chaps	479/579 Cabernet	491/591 Alpine	

Grade 8

Genuine Leather 100% Leather

450 Black	459 Chamois	470 Surf	471 Latte	472 Melon	473 Delta	474 Bronze
475 Rouge	476 Jade	477 Graphite	478 Chaps	479 Cabernet	491 Alpine	

Panel Fabrics

Grade 1

Agate II 100% Polypropylene

AG21 Bamboo AG22 Linen AG24 Slate AG25 Grey AG27 Mauve

Grade 2

Lola 100% Polyester Designed to color coordinate with Brinx and Mariposa panel fabrics.

LL11 Medium Taupe LL12 Caramel Cream LL13 Straw LL14 Blue Mist LL15 Zucchini LL16 Natural LL17 Cafe Au Lait
LL18 Mortar LL19 Black

Grade 3

Brinx 100% Polyester Designed to color coordinate with Lola and Mariposa panel fabrics.

BX01 Taupe BX02 Caramel BX03 Green Apple BX04 Brick BX05 Blue Steel BX06 Bisque BX07 Hot Chocolate
BX08 Golden

Mariposa 100% Polyester Designed to color coordinate with Lola and Brinx panel fabrics.

MA41 Mocha MA42 Blue Ocean MA43 Claypot MA44 Champagne MA45 Granny Smith MA46 Butterscotch MA47 Mixed Taupe MA48 Wheat

Grade 4

Accent 100% Polyester Fabric Grades are different when used on eO+ and GPS II panels. Please refer to 2017 Desking list price book for details.

GC31 Sand Dune GC32 Limestone GC33 Silver Mint GC34 Skyway GC35 Warm Beige GC36 Mid-Grey GC37 Green Olive
GC38 Cloud Blue GC39 Desert Cactus GC40 Cinder Block GC41 Sage Brush GC42 Brickworks

Finishes

Seating Finishes - Metal: Please consult each Seating Series for finish availability.

Black (BK) Charcoal Grey (CHR) Chrome (CH) Fog (FG) Polished Aluminum (ALU) Tungsten (TUN)

Seating Finishes - Plastic (Duet, Popcorn, and Sonic)

Asphalt Night (BLK) Caribbean Surf (CRS) Coffee Bean (CFB) Daffodil Day (DFD) Ivory Clouds (IVC) Latte Beige (LAB) Lip Smacker (LPS)
Platinum (PLT) Sea Glass (SEG) Tiger Orange (TIO)

Seating Finishes - Wood Seating finishes will not necessarily match Casegoods finishes. This is due to the fact that Seating and Casegoods finishes use different wood species and are manufactured at multiple locations.

Absolute (AAM) Black (BKM) Cherry (ACM) Espresso Cafe (ECM) English Oak (EOM) Fruitwood (TFM) Gray (HGM)
Honey (AHM) Mahogany (TMM) Maple (AVM) Medium Walnut (MWM) Night (ASM) Shaker Cherry (SKM) Walnut (TWM)
WC Cream (WTM) White (WHM) Winter Cherry (WCM)

Desks, Workstations, Tables and Accessories - Laminate

Absolute Acajou (ACJ) Asian Night (ASN) Avant Cherry (AWC) Avant Honey (AWH) Black (BLK) Brushed Cobalt (BRC) Constellation Java (CSJ)
Dark Espresso (DES) Grey (GRY) Hayden Grey (HGT) Quartered Mahogany (QTM) Shaker Cherry (SKC) Storm Grey (SOG) Tiger Fruitwood (TFW)
Tiger Mahogany (TMA) Tiger Maple (TMP) Tiger Walnut (TWL) White (WHT) White Chocolate (WHC) Willow Grey (WGY) Winter Cherry (WCR)

Desks, Workstations, Tables and Accessories - Veneer Wood

Almond Cherry (AMW) Caramel Bamboo (BAMC) Cocoa Walnut (CAW) Coral (CRW) Dark Cherry (DCW) Espresso Walnut (EWW) Evening Oak (EVW)
Grey on Oak (GRW) Hazelnut (HAW) Honey Maple (SMW) Java (JAW) Latte Walnut (LTW) Milestone (MTW) Mocha (MCW)
Natural Maple (MPW) Red Cherry (RCW) Vintage Cherry (VNW) Walnut (WLW) Warm Cherry (WCW) White Maple (WMW)

File Finishes - Standard

Black (BLK) Business Grey (BGR) Charcoal Grey (CGR) Desert Putty (DPT) Grey (GRY) Light Grey (LGR) Nevada (NEV)
Storm Grey (SGR) Tahiti Sand (TSA)

File Finishes - Premium

Bone (F29) Claret (F09) Cloud (F23) Designer White (DWT) Ice (F33) Ivory (F30) Metro (F07)
Moss (F05) Navy (F19) Oyster (F35) Stone (F32) Tungsten 2 (TU2) Willow (F28)

File Finishes - Textured

Black Coffee (U04) Dark Chocolate (T19) Cappuccino (T20) Mocha (J52) Vanilla (J23)

TEXTILES & FINISHES - LAMINATE FINISH CHART

FINISH CODE:	ACJ	ASN	AWC	AWH	BLK	BRC	CSJ	DES	GRY	HGT	QTM	SKC	SOG	TFW	TMA	TMP	TWL
LAMINATE DESKING																	
Adaptabilities	•	•	•	•	•	•	•	•	•	•	•	•	•	•	•	•	•
Correlation	•	•	•	•	•	•	•	•	•	•	•	•	•	•	•	•	•
Genoa	•	•	•	•	•	•	•	•	•	•	•	•	•	•	•	•	•
Halton	•	•	•	•	•	•	•	•	•	•	•	•	•	•	•	•	•
Princeton	•	•	•	•	•	•	•	•	•	•	•	•	•	•	•	•	•
Zira	•	•	•	•	•	•	•	•	•	•	•	•	•	•	•	•	•
METAL DESKING																	
StreamLINE	•	•	•	•	•	•	•	•	•	•	•	•	•	•	•	•	•
BENCHING																	
BRIDGES II - Tops	•	•	•	•	•*	•*	•	•	•	•*	•	•	•*	•	•	•	•
BRIDGES II - Chassis/Accents (screens, modesty panels)	•	•	•	•	•*	•*	•	•	•	•*	•	•	•*	•	•	•	•
PANELS + COMPONENTS																	
Divide	•	•	•	•	•	•	•	•	•	•	•	•	•	•	•	•	•
e0+	•	•	•	•	•	•	•	•	•	•	•	•	•	•	•	•	•
GPS II	•	•	•	•	•	•	•	•	•	•	•	•	•	•	•	•	•
TABLES - MEETING & CONFERENCE																	
Alba	•	•	•	•	•	•	•	•	•	•	•	•	•	•	•	•	•
Boardroom	•	•	•	•	•	•	•	•	•	•	•	•	•	•	•	•	•
Bungee	•	•	•	•	•	•	•	•	•	•	•	•	•	•	•	•	•
Connectables	•	•	•	•	•	•	•	•	•	•	•	•	•	•	•	•	•
Junction	•	•	•	•	•	•	•	•	•	•	•	•	•	•	•	•	•
Nutcracker	•	•	•	•	•	•	•	•	•	•	•	•	•	•	•	•	•
Zira Boardroom	•	•	•	•	•	•	•	•	•	•	•	•	•	•	•	•	•
TABLES - RECEPTION & OCCASIONAL																	
Citi	•	•	•	•	•	•	•	•	•	•	•	•	•	•	•	•	•
Folding Tables									•								
Laminate Occasional Tables	•	•	•	•	•	•	•	•	•	•	•	•	•	•	•	•	•
Reception Tables	•	•	•	•	•	•	•	•	•	•	•	•	•	•	•	•	•
Rectangular Work Tables				•					•								
Sirena Tables	•	•	•	•	•	•	•	•	•	•	•	•	•	•	•	•	•
Wind Tables	•	•	•	•	•	•	•	•	•	•	•	•	•	•	•	•	•
PRODUCTIVITY SOLUTIONS																	
Monoleg Height Adjustable Tables	•	•	•	•	•	•	•	•	•	•	•	•	•	•	•	•	•
Foli Height Adjustable Tables	•	•	•	•	•	•	•	•	•	•	•	•	•	•	•	•	•
FILING + STORAGE																	
Lateral File Tops	•	•	•	•	•	•	•	•	•	•	•	•	•	•	•	•	•
WOOD VENEER DESKING																	
DUFFERIN - Laminate Chassis					•					•			•				

* Bridges II finishes coordinate with metal paint finishes as follows: Black (BLK) - Black Paint (BLK); Brushed Cobalt (BRC) - Tungsten Paint (TUN); Hayden Grey (HGT) - Taupe Paint (TPE); Storm Grey (SOG) - Charcoal Paint (C); Silver Paint (SIL); String (STG) - Nevada Paint (NEV)

** Designer White (DWT) laminate is ONLY available on Bridges II in lieu of White (WHT) laminate. Finishes coordinate closely but are not an exact match.

*** River Cherry (RCL) laminate is ONLY available on Bridges II Chassis/Accents (Chassis, Screens, Modesty Panels, etc.). This finish is meant to coordinate closely when utilizing Winter Cherry (WCR) tops.

THINK GLOBAL/THINK GREEN



LEVEL 3 CERTIFIED
Many programs in various categories



LEED PARTNERSHIP PROGRAM
Products can help you earn credits



GREENGUARD CERTIFIED
Children & Schools Certified

THE ENVIRONMENT We believe now more than ever, that it is our responsibility to protect the environment and our precious natural resources for future generations. The growing importance of energy and environmental concerns continues to challenge us in this ever changing marketplace.

As an industry leader, Global continues to take proactive steps towards reducing the negative impacts on the environment. We are building "healthier" offices; investing in Research & Development and new technologies; reducing waste and the consumption of energy; and improving the quality of the air we breathe, all which can have a significant impact on our quality of life.



Epoxy Powder coating process is solvent free. No harmful VOC's or lead. No toxins are released into the atmosphere.

Global's recycled fabrics offer affordable, environmentally responsible alternatives to commercial textiles. We recycle 35,000 lbs of fabric offcuts weekly.



powder paint process:
98% paint recovery and reuse

more recycled fabric
less to the landfill

talk to us about our
leed partnership program

we've diverted
90% of our wood waste from landfill in four years



Global has the products and resources to help your projects achieve LEED certification.

New technology allows us to reduce glue usage by 50%. In addition, our polyurethane glue reduces emissions and requires less energy to apply.

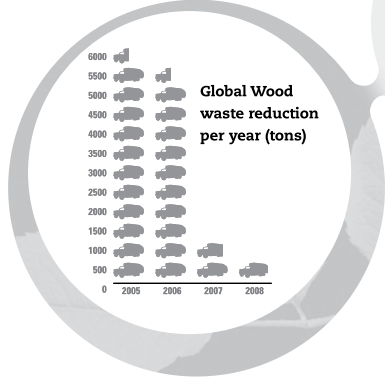

For further information on Global's environmental initiatives, please visit <https://www.globalfurnituregroup.com/us/company/environmental-commitment>

CUSTOM GROMMET LOCATION FORM

Model # _____ (Please use one page for each model #)

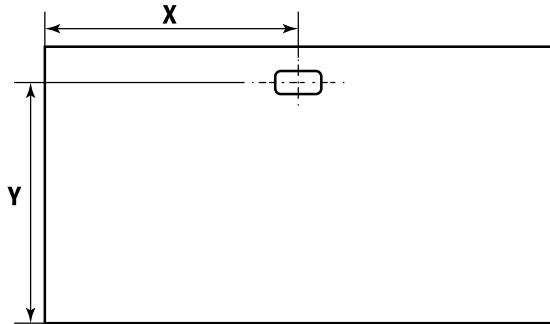

Operator Side

Template for Tops

X = _____

Y = _____

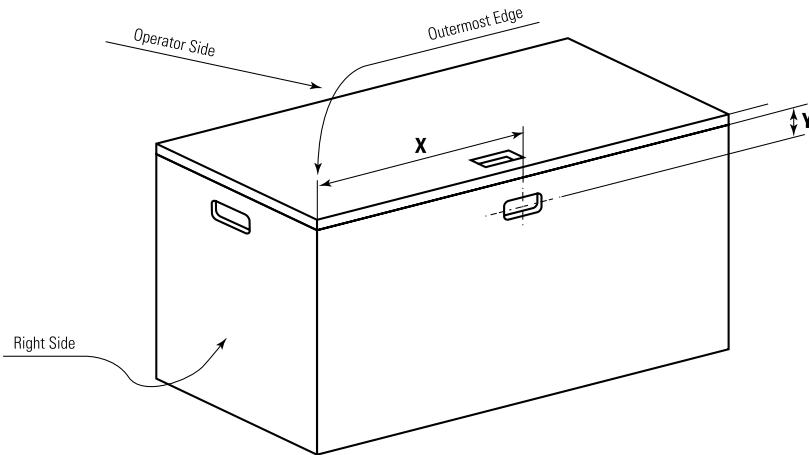
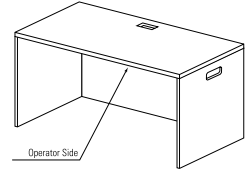

Template for Modesty Panels

X = _____

Y = _____

Note: X = Taken from outermost edge

Note: Y = Taken from underside of top

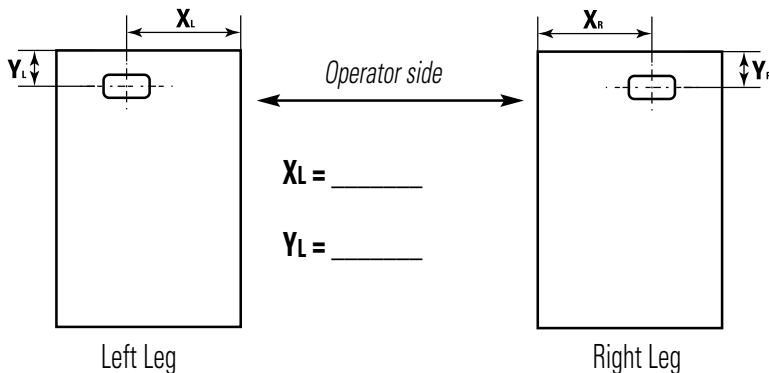

Left Leg

Right Leg

XL = _____

YL = _____

Template for Legs

XR = _____

YR = _____

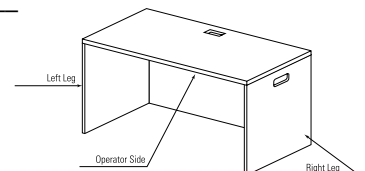

This form is to be used for non-standard cutouts.

CUSTOMER SPECIFIED CUTOUTS - ZIRA Boardroom Tables Only (96" Table)

Model # _____ (Please use one page for each model #)

Please check all that apply

CUTOUT POSITION(S)

- Position 1 (Over Left Base – Always 24.6" to Center Point of Cutout from Left Edge) (Use Option Code CCU1)
- Position 2 (Center of Table) (Use Option Code CCU2)
- Position 3 (Over Right Base – Always 24.6" to Center Point of Cutout from Right Edge) (Use Option Code CCU3)
- Custom Position(s) – Please Indicate on diagram below with dimensions to **Center Point** of cutouts (Use Option Code CCUS)

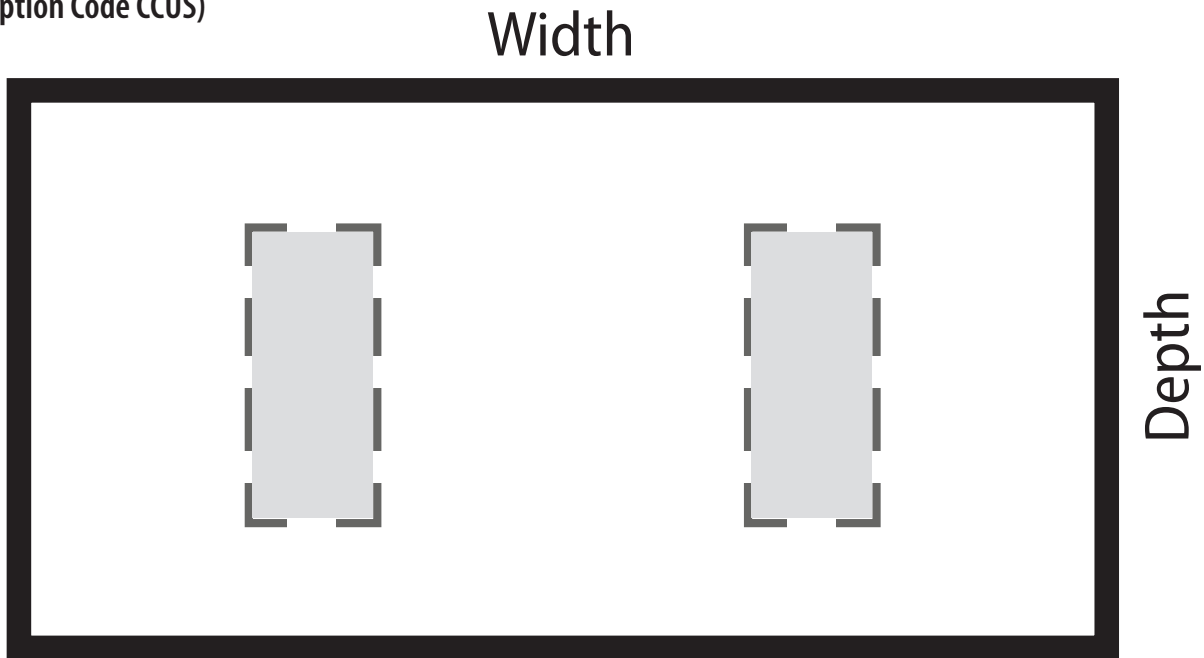

CUTOUT DIMENSIONS

All cutouts require a minimum 8mm radius at each corner.

Cutouts must be centered on the depth of each table due to wire management runners below the worksurface.

Electrical components that extend more than 3.75" below the worksurface **CANNOT** be positioned over bases.

_____ X Dimensions of cutout run the width of the table.

_____ Y Dimensions of cutout run the depth of the table.

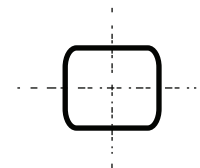

Dealer PO# _____

Internal Use Only

Global Order# _____

Global Trailer/Load #: L _____ ID #: _____

This form is to be used for non-standard cutouts.

CUSTOMER SPECIFIED CUTOUTS - ZIRA Boardroom Tables Only (120" - 168" Table)

Model # _____ (Please use one page for each model #)

Please check all that apply

CUTOUT POSITION(S)

- Position 1 (Over Left Base – Always 25.2" to Center Point of Cutout from Left Edge) (Use Option Code CCU1)
- Position 2 (Center of Table) (Use Option Code CCU2)
- Position 3 (Over Right Base – Always 25.2" to Center Point of Cutout from Right Edge) (Use Option Code CCU3)
- Custom Position(s) – Please Indicate on diagram below with dimensions to **Center Point** of cutouts (Use Option Code CCUS)

Width

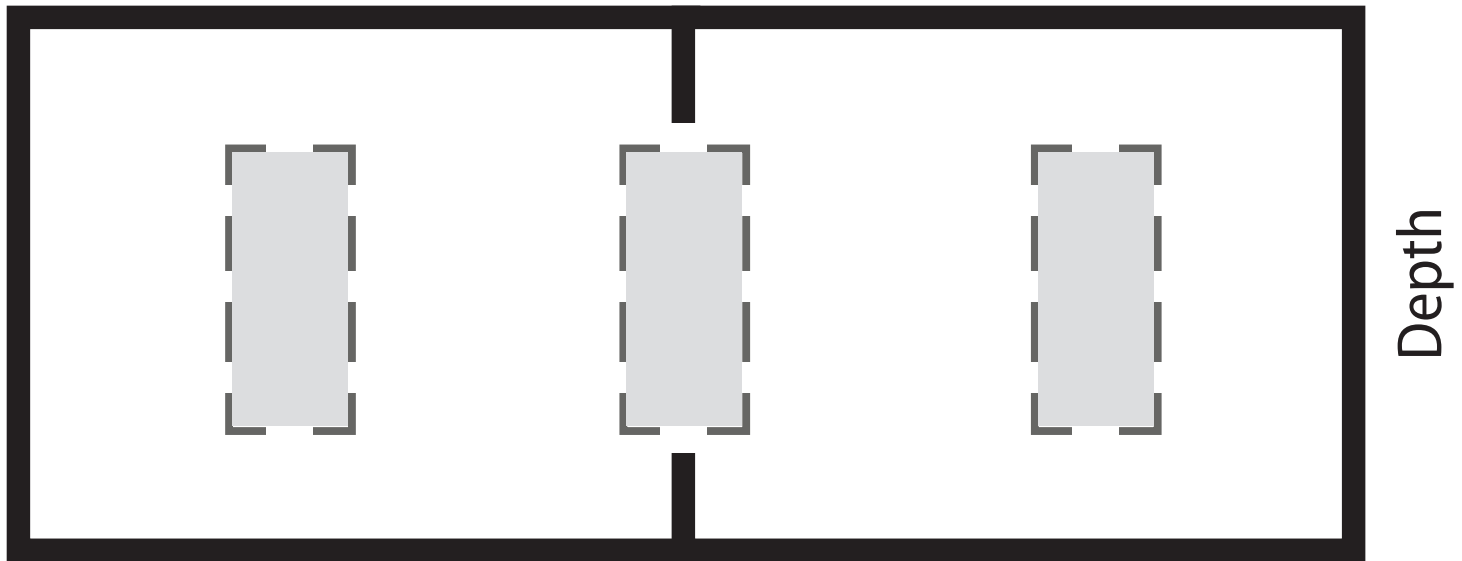

CUTOUT DIMENSIONS

All cutouts require a minimum 8mm radius at each corner.

Cutouts must be centered on the depth of each table due to wire management runners below the worksurface.

Electrical components that extend more than 3.75" below the worksurface **CANNOT** be positioned over bases.

_____ X Dimensions of cutout run the width of the table.

_____ Y Dimensions of cutout run the depth of the table.

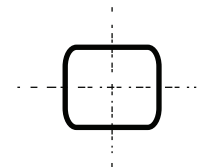

Dealer PO# _____

Internal Use Only

Global Order# _____

Global Trailer/Load #: L _____ ID #: _____

This form is to be used for non-standard cutouts.

CUSTOMER SPECIFIED CUTOUTS - ZIRA Boardroom Tables Only (192" - 288" Table)

Model # _____ (Please use one page for each model #)

Please check all that apply

CUTOUT POSITION(S)

- Position 1 (Over Left Base – Always 25.2" to Center Point of Cutout from Left Edge) (Use Option Code CCU1)
- Position 2 (Center of Table) (Use Option Code CCU2)
- Position 3 (Over Right Base – Always 25.2" to Center Point of Cutout from Right Edge) (Use Option Code CCU3)
- Custom Position(s) – Please Indicate on diagram below with dimensions to **Center Point** of cutouts (Use Option Code CCUS)

Width



CUTOUT DIMENSIONS

All cutouts require a minimum 8mm radius at each corner.

Cutouts must be centered on the depth of each table due to wire management runners below the worksurface.

Electrical components that extend more than 3.75" below the worksurface **CANNOT** be positioned over bases.

_____ X Dimensions of cutout run the width of the table.

_____ Y Dimensions of cutout run the depth of the table.

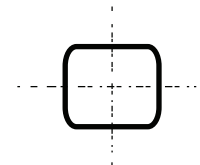

Dealer PO# _____

Internal Use Only

Global Order# _____

Global Trailer/Load #: L _____ ID #: _____

This form is to be used for non-standard cutouts.

CUSTOMER SPECIFIED CUTOUTS - ZIRA Boardroom Tables Only (Square Tables)

Model # _____ (Please use one page for each model #)

Please check all that apply

CUTOUT POSITION(S)

Position 2 (Center of Table)
(Use Option Code CCU2)

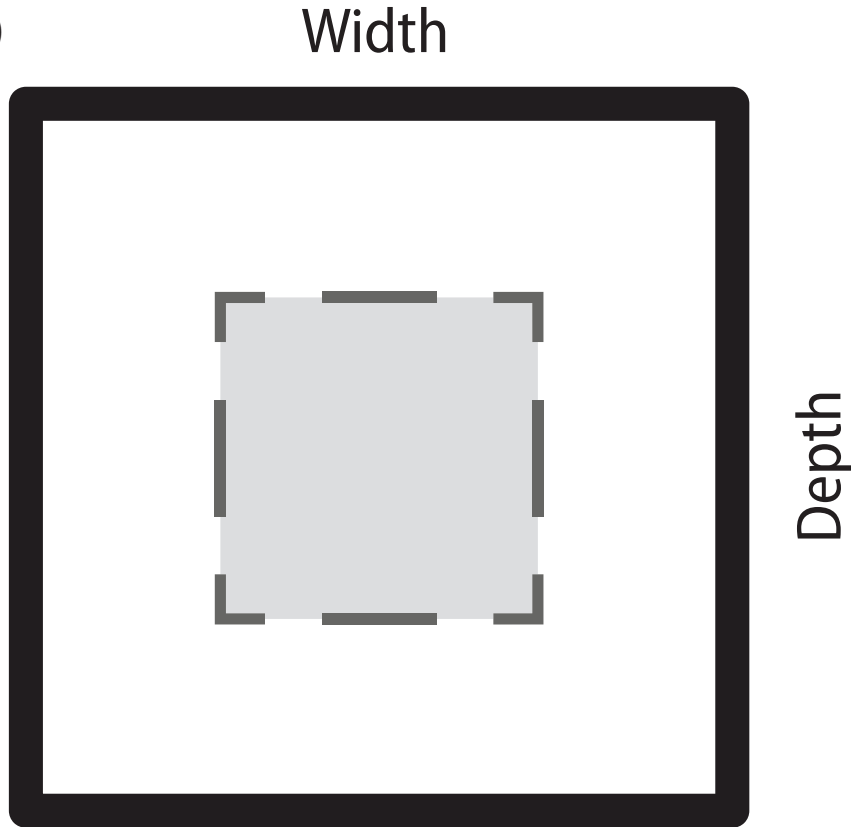

CUTOUT DIMENSIONS

All cutouts require a minimum 8mm radius at each corner.

Cutouts must be centered on the depth of each table due to wire management runners below the worksurface.

Electrical components that extend more than 3.75" below the worksurface **CANNOT** be positioned over bases.

_____ X Dimensions of cutout run the width of the table.

_____ Y Dimensions of cutout run the depth of the table.

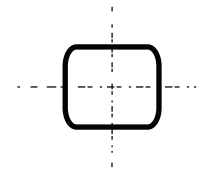

Dealer PO# _____

Internal Use Only

Global Order# _____

Global Trailer/Load #: L _____ ID #: _____

This form is to be used for non-standard cutouts.

CUSTOMER SPECIFIED CUTOUTS - ZIRA Media Tables Only

Model # _____ (Please use one page for each model #)

Please check all that apply

CUTOUT POSITION(S)

- Position 1 (Over Left Base – Always 24.6" to Center Point of Cutout from Left Edge) (Use Option Code CCU1)
- Custom Position(s) – Please Indicate on diagram below with dimensions to **Center Point** of cutouts (Use Option Code CCUS)

Width

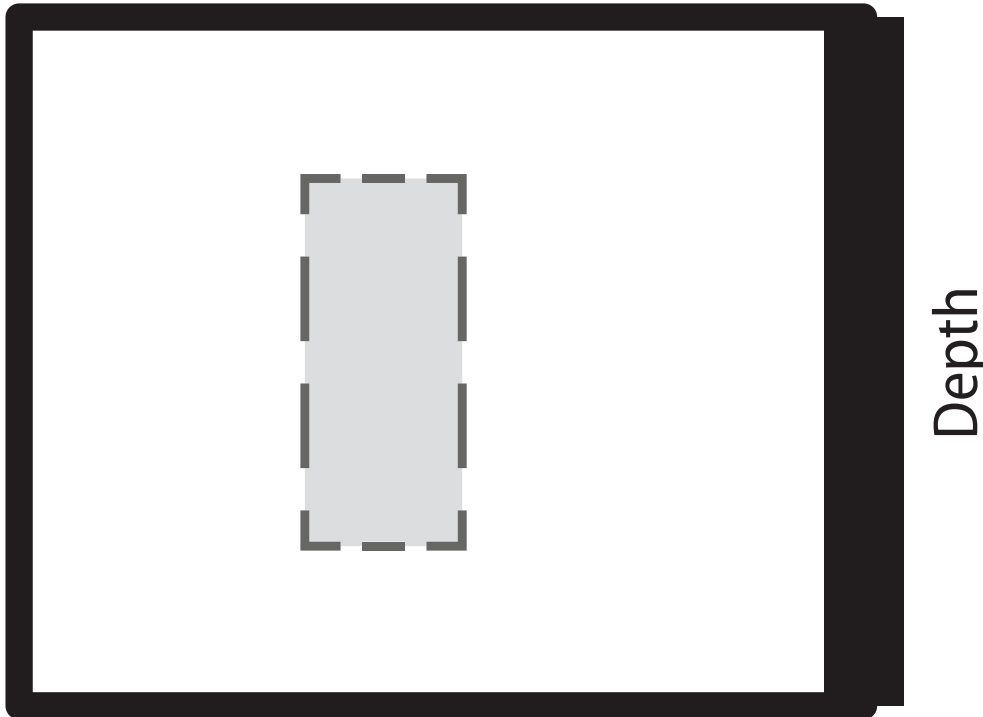

CUTOUT DIMENSIONS

All cutouts require a minimum 8mm radius at each corner.

Cutouts must be centered on the depth of each table due to wire management runners below the worksurface.

Electrical components that extend more than 3.75" below the worksurface **CANNOT** be positioned over bases.

_____ X Dimensions of cutout run the width of the table.

_____ Y Dimensions of cutout run the depth of the table.

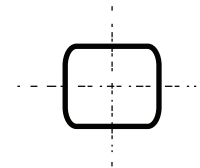

Dealer PO# _____

Internal Use Only

Global Order# _____

Global Trailer/Load #: L _____ ID #: _____

This form is to be used for non-standard cutouts.

CUSTOMER SPECIFIED CUTOUTS - ZIRA Collaborative Tables Only

Model # _____ (Please use one page for each model #)

Please check all that apply

CUTOUT POSITION(S)

- Position 1 – Always 24.6" to Center Point of Cutout from Left Edge) (Use Option Code CCU1)
- Position 2 (Center of Table) (Use Option Code CCU2)
- Position 3 – Always 24.6" to Center Point of Cutout from Right Edge) (Use Option Code CCU3)
- Custom Position(s) – Please Indicate on diagram below with dimensions to **Center Point** of cutouts (Use Option Code CCUS)

Width

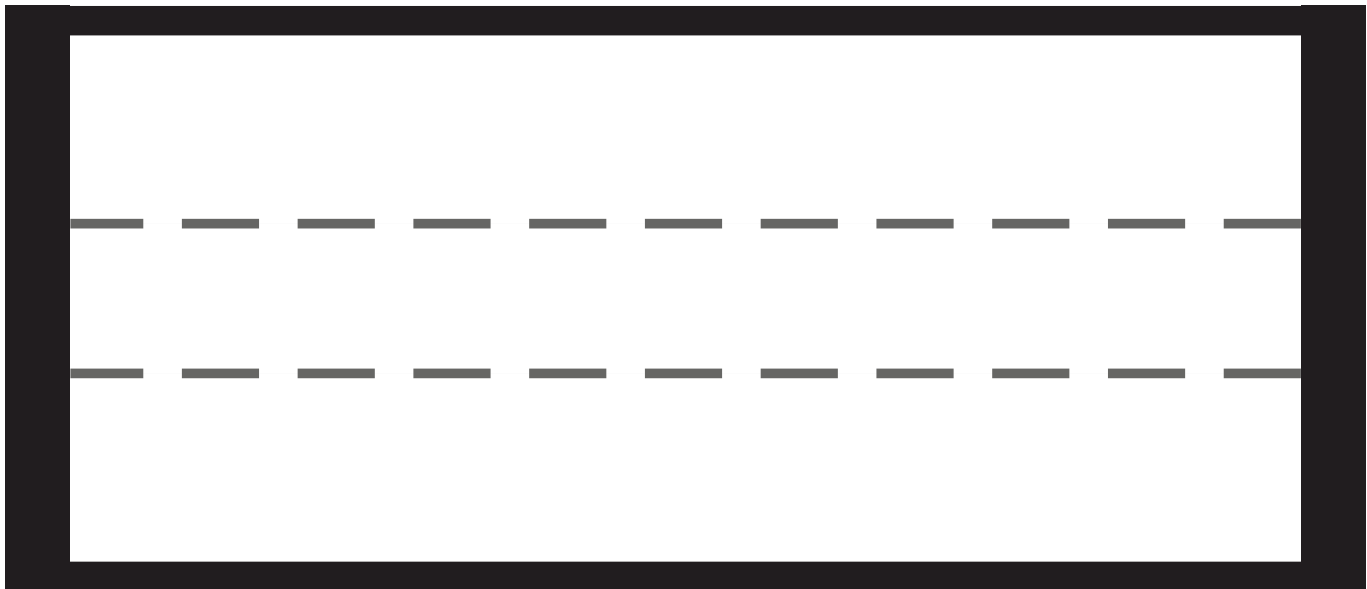

Depth

CUTOUT DIMENSIONS

All cutouts require a minimum 8mm radius at each corner.

Cutouts must be centered on the depth of each table due to wire management runners below the worksurface.

_____ X Dimensions of cutout run the width of the table.

_____ Y Dimensions of cutout run the depth of the table.

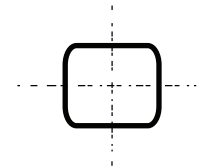

Dealer PO# _____

Internal Use Only

Global Order# _____

Global Trailer/Load #: L _____ ID #: _____

TERMS & CONDITIONS

This illustrated price list has been designed to facilitate fast reference and easy use. All products are categorized into "seating", "desks", "files", "panels", "tables" and "modular furniture", and are listed numerically within their categories. The line drawings match actual photographs (where possible) to aid in instant recognition of the total range within a series.

Sales of Global-The Total Office ("Global") products are made only on Global's standard terms and conditions of sale which are contained in this Price Book. These standard terms and conditions may be modified or supplemented only by a separately written document signed by Global's authorized personnel at its head office in Marlton, NJ. Any term or condition contained in any purchase order or other form used by dealer/purchaser to order goods (including standard, printed language) which is different from, in addition to, or in any way inconsistent with Global's standard terms and conditions shall be of no force or effect whatsoever.

All illustrations, specifications and prices in this book are based on the latest product information available at the time of publication. Global reserves the right to make changes, at any time and without prior notice, to prices, colors, materials, specifications and models offered.

Description

Each product shown or described in this price list is standard Global product. Variations are noted at the beginning of each series. Any variations from what is standard may require additional delivery time and cost and may affect the warranty given. Sizes and weights shown are approximate and are subject to slight changes from time to time.

Prices and Payment

The prices shown in this book, as well as those quoted by Global, are in United States dollars for orders shipped to destinations in the U.S. and Mexico.

If shipping date requested is more than 90 days from date of order, Global shall have the right to use published list prices effective at the time of shipment.

Orders are invoiced at the time of shipment. Terms of payment are net 30 days from date of invoice (1% 15 days) unless otherwise stated. The customer agrees that Global shall have the right to enforce a charge amounting to 1.5% per month (18% per year) on invoices outstanding more than 30 days.

If dealer/purchaser's most recent annual net volume is less than \$5,000.00, payment must be made in advance.

Any products sold by Global shall remain the personal property of Global until fully paid.

Prices are suggested list prices only and are subject to change without notice. Global will, however, attempt to keep dealer/purchasers up-to-date on all developments including price changes.

Taxes

All prices shown in this book are exclusive of sales, use, excise and other applicable taxes and are the dealer/purchaser's responsibility as per the invoice issued by Global. If dealer/purchaser claims an exemption from such taxes, it shall be the dealer/purchaser's responsibility to furnish Global with an appropriate exemption certificate at time of order.

Ordering Information

To avoid errors and/or duplication Global requires that all orders be submitted in writing. All orders submitted to Global in writing will be acknowledged on Global's acknowledgement forms governing the transaction. The details appearing on this acknowledgement will describe the items to be shipped and the approximate shipping date. It is the dealer/purchaser's responsibility to determine that the information in the acknowledgment is correct. In the event of an error, the dealer/purchaser must notify Global immediately by telephone followed by written confirmation. Shipping dates are assigned to orders based on the item having the longest manufacturing lead time.

When ordering, please provide the following information:

- 1) Account number (if possible)
- 2) P.O. number
- 3) "Bill to" and "ship to" name and address
- 4) Complete model number
- 5) Description
- 6) Options:
 - a. Upholstery fabric type and color (specify by name and number)
 - b. Color of paint finish, laminate or wood (if applicable)
 - c. Trim options (frame)
 - d. Arms
 - e. Base, Casters
 - f. Mechanism
 - g. Accessories

Dealer/purchaser is responsible for providing correct information when placing an order. Orders with incorrect information (finish, etc.) will be scheduled for manufacturing upon receipt of complete information.

All phone orders must be confirmed in writing by the customer within 7 days.

To prevent a delay in processing orders, please specify delivery routing.

Changes and Cancellations

After the date of Global's acknowledgment of a dealer/purchaser's order, the order may not be changed or cancelled by dealer/purchaser without the written consent of Global. Special order items, C.O.M. and fabric-covered items already in production are not subject to change or cancellation under any circumstances. Fabric-covered items are considered to be in production once the fabric is scheduled for cutting. Other standard items already in production are subject to a minimum 35% cancellation charge.

Errors and Omissions

All quotations, acknowledgements and invoices are subject to corrections for any errors and omissions.

FINISHES

Seating Finishes

Where painted frames are not a standard color, there is a one time charge of \$578.00 list price per-order for custom wood staining/color matching. Restrictions may apply. The customer must provide a 3" x 3" color chip/sample. Non-standard finishes must be approved by Global prior to acceptance of order.

File Finishes

All non-standard finishes must be approved by Global prior to acceptance of order and may be subject to an upcharge.

Laminated Tops - Pricing for all non-standard finishes and sizes must be provided by Global Customer Service and may be subject to an upcharge.

Desk Finishes

Because the distinctive characteristics and the nature of wood products cause variations, exact matches are not always possible.

Global has launched a finishes program between marketing companies within the Global Group to match products as best as possible when same finishes are specified.

C.O.M. (Customers Own Material)

Use of Customer's Own Material must be approved by Global prior to acceptance of order. Please refer to page 348 of the Price Book and fill out the Authorization Request Form. Photocopy and use this form as often as necessary. The customer must provide a 12" x 12" fabric sample and advise how the fabric is to be applied. **Fabric yardage requirement will be advised by the factory, and additional yardage may be required if pattern requires matching.** Yardage shown in the List Price Book does not allow for pattern repeat/matching. Send to the address provided on shipping document upon approval from Global. If C.O.M. is difficult to apply or if product shall be modified, extra charges shall be made. Global reserves the right to cancel an order at any time if C.O.M. is inadequate for any reason. Customer's Own Material must be shipped freight and duties paid to our factory. Such shipment must be fully identified with purchaser's order number, RGA # provided by Global, and the item for which material is intended. Performance of C.O.M. when applied to product is the sole responsibility of the purchaser. Global's standard product warranty shall not apply to C.O.M. Use of C.O.M. will not reduce the published list price.

Textile Grading

All products are priced according to their standard fabric and fabric grade. Lower grade fabrics are available (unless otherwise specified) at same price as standard.

The listing of prices for each model indicates the prices for higher upholstery grades. Prices are based on yardage in imperial measurements.

TEXTILE PRICE GRADES - GLOBAL TEXTILES

Grade	Upholstery (Seating Fabrics)
1	Drama, Hudson, Jenny, Mock Leather, Pebbles, Quilt, Sprinkle, Station, Terrace, Urban, Waterfall
2	Allante, Crescent, Cumulus, Imprint, Match, Oxygen, Quantum, Renewal, Replay, Silhouette
3	Couture
5	Leather/Mock Leather Combination
8	Genuine Leather

Grade Upholstery (Panel Fabrics)

1	Agate II
2	Coordinate, Lola
3	Accent, Brinx, Mariposa

The charts above do not include Textiles offered by Alliance Partners: Arc-Com Fabrics, CF Stinson, Designtex, Knoll Textiles, Green Hides, LDI, Lumm Textiles, Maharam, Mayer Fabrics, Momentum, and Ultrafabrics.

Upholstery Coverings

Slight variations in color may occur between dye lots. Although Global attempts to minimize these variances, they do occur and must be accepted as normal and will not be considered defects.

Yardage

Required yardage (ydg) is based on unmatched materials with widths of 54" for seating, 63" for GPS panels. Yardage calculations are based on imperial measurements.

Arms

A wide selection of arms are available for some series. See Arm Charts for details.

Delays

Global's shipping confirmation will state a shipping date which is Global's best estimate at the time the order is acknowledged. However, Global shall not incur any obligation or liability to Purchaser for failure to ship by specified date unless Global has agreed to an unequivocal shipping date in a separately signed written document executed by its authorized personnel at its head office. In addition, Global shall not be liable for any loss or damage resulting from any delay or failure in shipment or other failure to perform all or any part of the agreement between the parties with respect to the goods shown on the face of the order acknowledgement where such delay, failure, loss or damage is the proximate result of any act of any governmental authority or political subdivision thereof, revolution, riot, civil disorder or disturbance, delay or default in transportation, strike disputes among or between labor unions or other labor disputes, delay or inability in obtaining materials and facilities, fire, flood, act of God or any cause not within the reasonable control of the company, whether of the class of causes enumerated or otherwise.

F.O.B.

F.O.B. point is Global's Factory, Downsview, Ontario, Canada, or any Global Regional Distribution Center.

UPS Shipments

Seating products marked with a UPS symbol are packaged for UPS-able shipments.

Handling

A \$25. net handling charge per shipment will be applied for non UPS-able orders of less than \$2000. list.

Special Delivery Requirements

Global's delivered pricing provides for dock delivery during normal business hours (considered to be 8 am to 4 pm Monday through Friday) to customer/end user only. Additional delivery requirements such as inside delivery, lift gate, limited access sites, installations and weekend deliveries will incur an additional expense and will be the responsibility of the dealer.

Service

Service requests are normally the responsibility of Global's authorized dealers. Where this cannot be accomplished on a local level, service problems should be referred to Global's Customer Service Department in the nearest distribution center.

Returns

No returns of goods will be accepted without written consent and shipping instruction of Global. A minimum re-stocking charge of 35% is made on all authorized returns for credit or refund, provided goods are received by Global in the condition in which they left the factory. This

may increase depending on the type of product. Global's Return Goods Authorization (R.G.A.) numbers must appear prominently on all authorized returns. Global will not be responsible for freight costs. No credit will be given if goods cannot be reused as new. Special order items, non-stock items and C.O.M. products are in no event subject to return. All returns must be approved and authorized in writing by Global Customer Service. Global reserves the right to refuse delivery of any unauthorized returns.

Claims

All goods are sold F.O.B. plant or Global Distribution Center. Global is not responsible for damage which occurs in transit (or in storage). The carrier signs for all goods received in apparently good order. It is the dealer/purchaser's responsibility to examine goods upon receipt and to file any claims with the carrier for losses or damage to the product occurring during transit, including concealed damage.

Any claims made against Global for apparent defects, errors or shortages must be made by the dealer/purchaser, in writing, within 15 working days after any delivery. Failure by the dealer/purchaser to make any claim against Global within 15 days shall constitute acceptance of the goods and a waiver of any apparent defects, errors or shortages.

Suspension

In the event that the dealer/purchaser defaults in the payment of any sum due to Global, or in the event the dealer/purchaser's financial condition becomes unsatisfactory to Global, Global shall have the right to defer or discontinue shipment of any goods until such time as the default is cured or the dealer/purchaser provides assurance of payment to Global.

Copyright

All catalogs, photographs, drawings, price lists and other printed material are protected by copyright. All rights reserved.

Trademarks

All trademarks are owned by Global Total Office other than OBUSFORME™ which is owned by OBUSFORME LTD. and are used under license. OBUSFORME® and the distinctive backrest design are registered trademarks of OBUSFORME LTD.

Designs and Patents

Many of the products produced by Global are protected by design registrations, design patents and/or patents. Design and specifications are subject to change, discontinuance or additions without notice.

Cubic Measure

The stated cubage is an approximate cubic foot measure to calculate freight costs. The figure shown is the volume for one carton and is subject to change without notice. It is most economical to purchase the specified number per carton.

Combined Shipments

Global will make every effort to combine shipments and orders on written request. However, Global cannot be held responsible where such request is not complied with.

Offer of Sale

Possession of this price list or any other literature shall not imply the company's willingness to sell to the holder and shall not be construed as a direct offer of sale.

If a conflict arises between: (i) prices found in software support packages furnished to the customer by Global or by any other source on behalf of Global; and (ii) Global's current printed price lists, then the most current shall prevail.

Disclaimer

All dimensions are in inches. Prices shown are current manufacturer's suggested list prices at the time of printing. All applicable taxes are extra. Descriptions, specifications and prices are subject to change without notice. Errors and omissions are subject to correction.

Flammability

The foam used in Global chairs meets the requirements of California TB117. In addition, a number of Global seating models can be certified to California TB133. This available certification can be done when selected seating models are upholstered in specific fabrics. The list of certifiable seating models and available fabrics changes from time to time. Please contact Customer Service for a list of certifiable models and upholstery materials.

Special CAL 133 Upcharges

All plastic series/models within the Duet, Popcorn, and Sonic series do not have an upcharge (\$0). All Vion models with mesh backs require a \$150 list upcharge. All Softcurve models require a \$209 list upcharge. Please see Chart below for additional upcharges on products that can be certified to California TB133.

This list price book is effective as of January 1st, 2017.

For periodic updates, please check the PDF at www.globalfurnituregroup.com. After login, select INFORMATION, then GLOBAL, and then PRICE BOOK/PRICING. Global warrants that all commercial products are free from defects in material and workmanship, for the life of the product, to the original purchaser.

CAL 133 UPCHARGES

PRODUCT CATEGORY	SERIES	FABRIC	VINYL	LEATHER
Plastic Stacking/Nesting w/ Upholstered Pad(s)	All Series	\$74	\$74	\$74
Guest, Task, Management, Conference, Executive	All Series	\$110	\$110	\$110
Lounge — Single Seat	All Series	\$209	\$209	\$209
Lounge — 2 Seate	All Series	\$314	\$314	\$314
Lounge — 3 Seater	All Series	\$418	\$418	\$418

LIFETIME WARRANTY

Global will repair or replace, at Global's option, as the sole remedy for any defect covered by the warranty. The warranty applies to products manufactured after January 1, 2011.

General Commercial Seating

Global's warranty for general commercial seating covers all chair components including pneumatic cylinders, bases, casters, glides, frames, arms, plastic seats, backs and other structural components.

Exceptions to the warranty for general commercial seating are as follows:

- Foam, textiles (as sampled on Global branded and textile program cards), mesh material and electrical devices, are warranted for five (5) Years
- Control mechanisms are warranted for twelve (12) Years

The warranty applies to single shift, standard commercial usage, defined as a standard eight (8) hour day, forty (40) hour week for users weighing up to 300 pounds. ObusForme Comfort XL falls under the General Commercial Seating Warranty with the exception the weight rating is for users up to 400 pounds.

Heavy Duty Seating

Global offers products designed for multiple shift applications (24 hours a day / 7 days a week) and larger individuals weighing up to 350 and/or 500 pounds (depending on series and/or model). Global warrants these products for twelve (12) years to the original purchaser. All components (including control mechanisms, pneumatic cylinders, bases, casters, glides, frames, arms, plastic seats/backs, etc.) are covered for 24/7 applications under the warranty. The exceptions are foam and textiles, which are covered for five (5) years. Textiles on these products must exceed 100,000 double rubs for the textile portion of the warranty to apply. Heavy Duty product series that apply under this warranty currently include: Concord Executive 24 hour, Dexter/Dexter+, Granada TS, Granada Deluxe TS, Malaga TS, Mallorca TS, Maxima II, ObusForme Comfort TS, Robust, Saxon, Stamina+, Truform TS, Vion TS and Yorkdale TS.

Light Use Seating

Global offers light use seating that is warranted for ten (10) years for the original purchaser. The warranty covers all components (frames, glides, and arms). The foam/textiles are warranted for five (5) years. The warranty on these light use series is for an eight (8) hour day, forty (40) hour week for users up to 200 pounds. Light use product series that apply under this warranty currently consists of Key series.

Textiles

Global warrants Global branded textiles and Alliance Partner carded textile programs inclusive of fabrics, vinyls and leather products for five (5) years. Alliance Partner carded textile programs are currently with Arc-Com Fabrics, CF Stinson, Designtex, Knoll Textiles, Green Hides, LDI, Lumm Textiles, Maharam, Mayer Fabrics, Momentum, and Ultrafabrics. Global does not warrant COM (Customer Own Materials) or graded-in materials (non-carded) and purchased by Global for a customer. For graded-in or COM products, please contact the textile supplier for performance information and warranty details.

Seating Warranty Summary

Seating Type	Components Warranty For Original Purchaser	Use Time For Warranty Coverage	Exceptions
General Commercial Seating	Lifetime	8 Hours/5 Days Per Week	Foam/Textiles/Mesh/Electrical Devices - 5 Years Control Mechanisms - 12 Years
Heavy Duty Seating	12 Years	24 Hours/7 Days Per Week	Foam/Textiles - 5 Years
Light Use Seating	10 Years	8 Hours/5 Days Per Week	Foam/Textiles - 5 Years

Files, Desks, Modular Furniture, Tables, Panels & Accessories

Global warrants all components of metal storage and filing, laminate and wood veneer desks, laminate and wood veneer tables, metal leg components and panels for the lifetime of the product to the original purchaser.

Exceptions to the warranty for Files/Desks/Tables and Panels are as follows:

- Electrical devices, panel and tackboard textiles, adjustable keyboard mechanisms/lecterns/coat trees and task lights – five (5) Years
- Folding tables (laminate and Lite Lift II models) – one (1) Year

Files, Desks, Modular Furniture, Tables, Panels & Accessories Warranty Summary

Product Type	Components Warranty For Original Purchaser	Exceptions
Metal Storage and Filing	Lifetime	None
Laminate/Wood Veneer Desks and Modular Furniture	Lifetime	Tackboard Textiles , Electrical Devices,Task Lights - 5 Years
Productivity Solutions - Foli Height Adjustable Tables	Lifetime	Steel components - 10 Years, Moving components - 5 Years, All electrical components - 2 Years
Boardroom, Conference and Training Tables	Lifetime	Electrical Devices - 5 Years
Panels	Lifetime	Panel Textiles, Electrical Devices, Task Lights - 5 Years
Coat Racks and Lecterns	5 Years	None
Folding Tables (Laminate & Molded)	1 Year	None

Global's Warranty does not apply (for any product category) to the following:

- Failures due to wear and tear
- Failures which result from negligence, abuse, accident or misuse
- Failure to apply, install or maintain products according to Global's written instructions and warnings
- Modifications, attachments or repair methods not approved by Global
- Damage caused by a carrier in transit, or delivery/installation contractors
- The matching of colors, grains or textures (wood, leather, etc.) of natural materials and color matching of textiles
- Products exposed to extreme hot or cold temperatures or excessively dry or humid environments
- Colorfastness or the matching of color of textiles
- Damage by markings or staining; damage by sharp objects or imprinting from instruments
- Damage to textiles or laminate and wood surfaces/edges from exposure to sunlight (including UV rays)
- Products used for rental purposes

Global's warranty does not cover the costs of transportation or labor. Repair or replacement will be at Global's option.

Global makes no warranty that any of its products are suitable for any particular purpose and makes no other warranties, express or implied, other than those set out here. As codes and standards vary from one jurisdiction to another, references to compliance are solely for convenience and without any representation as to accuracy or suitability. Users must verify the suitability of such information or product for their specific application. In no event shall Global be liable in either tort or contract for any loss or direct, special, incidental, consequential, or exemplary damages.

Global's warranty applies to products sold within the United States of America, Mexico, the Commonwealth of Puerto Rico and Canada.

Global US Headquarters/Distribution Center

17 West Stow Road, P.O. Box 562
 Marlton, New Jersey U.S.A. 08053
 T (856) 596-3390
 T (800) 220-1900
 F (856) 596-5684

A \$25 net handling charge per shipment
 will be applied for non-UPSable orders of
 less than \$2,000 list.

Showrooms**Atlanta**

10 10th Street
 Suite 150
 Atlanta, GA 30309
 T (404) 879-0998
 F (404) 879-9995

Boston

One Harbor Street
 Suite 104
 Boston, MA 02210
 T (617) 406-5435
 F (617) 406-5438

Chicago

The Merchandise Mart
 222 Merchandise Mart Plaza
 10th Floor, Suite 1035
 Chicago, IL 60654
 T (312) 755-0843
 F (312) 755-0837

Detroit Area

25925 Telegraph Road
 Suite 145
 Southfield, MI 48034
 T (248) 357-7211
 F (248) 357-7241

Ft. Lauderdale

Las Olas City Centre
 401 East Las Olas Blvd.
 Suite 230
 Ft. Lauderdale, FL 33301
 T (954) 763-2684
 T (800) 331-0529
 T (954) 763-6870

New York City

386 Park Avenue South
 7th floor
 New York, NY 10016
 T (212) 545-9900
 T (888) 315-1301
 F (212) 545-5826

Philadelphia Area

119 Greentree Road
 Marlton, NJ 08053
 T (856) 596-3390
 T (800) 220-1900
 F (856) 596-4472

Phoenix

4675 E Cotton Center Blvd.
 Suite 165
 Phoenix, AZ 85040
 T (602) 426-0666
 T (602) 426-0777
 F (602) 426-1148

St. Louis

5 Document Drive
 St. Louis, MO 63114
 T (314) 432-4463
 F (314) 432-4471

Washington, DC

1130 Connecticut Avenue
 10th Floor, Suite 1000
 Washington, DC 20036
 T (202) 659-0230
 T (202) 659-0236
 F (202) 659-0306

Distribution Centers**Atlanta Area**

2124 Evergreen Blvd.
 Duluth, GA 30096
 T (678) 602-4130
 T (800) 220-7328
 F (678) 602-4136

Baltimore Area

Troy Hill Corporate Center
 7030 Troy Hill Drive
 Elkridge, MD 21075
 T (410) 379-8021
 T (800) 863-7300
 F (301) 362-9444

Boston Area

19 Connector Road
 Unit 1
 Andover, MA 01810
 T (978) 470-8463
 T (800) 876-8980
 F (978) 470-8920

Chicago Area

1879 Internationale Blvd.
 Glendale Heights, IL 60139
 T (630) 681-2818
 T (800) 866-6497
 F (630) 681-1631

Cincinnati Area

8712 LeSaint Drive
 Fairfield, OH 45014
 T (513) 777-0009
 T (800) 552-3375
 F (513) 777-5863

Dallas Area

2025 West Beltline Road
 #100
 Carrollton, TX 75006
 T (972) 236-1366
 T (800) 929-2936
 F (972) 236-1372

Denver Area

16401 East 33rd Drive
 Suite 50
 Aurora, CO 80011
 T (303) 340-1617
 T (800) 275-6655
 F (303) 340-1657

Ft. Lauderdale Area

560 Sawgrass Corp. Pkwy
 Sunrise, FL 33325
 T (954) 846-8888
 T (800) 331-0529
 F (954) 846-8110

Houston Area

7865 Northcourt Road
 Building D, Suite 200
 Houston, TX 77040
 T (713) 695-5777
 T (800) 935-6468
 F (713) 695-5778

Los Angeles Area

12320 Bloomfield Avenue
 Unit A
 Santa Fe Springs, CA 90670
 T (562) 484-9686
 T (800) 640-0301
 F (562) 484-9685

Minneapolis Area

2000 Freeway Boulevard
 Brooklyn Center, MN 55430
 T (763) 560-8196
 T (800) 829-2153
 F (763) 560-2098

New Orleans Area

901 South Labarre Road
 Suite 201
 Metairie, LA 70001
 T (504) 834-6228
 T (800) 275-0663
 F (504) 835-9638

Pittsburgh Area

380 Leetsdale Industrial Dr.
 Leetsdale, PA 15056
 T (724) 385-1200
 T (800) 942-9999
 F (724) 385-1207

San Antonio Area

6950 Alamo Downs Pkwy
 Suite 100
 San Antonio, TX 78238
 T (210) 684-8450
 T (800) 683-4000
 F (210) 684-3700

San Francisco Area

44091 Nobel Drive
 Fremont, CA 94538
 T (510) 897-4150
 T (888) 418-4800
 F (510) 897-4156

Seattle Area

Oakesdale Commerce Ctr.
 820 Southwest 34th Street
 Building W7, Suite A
 Renton, WA 98057
 T (425) 291-9282
 T (888) 218-2600
 F (425) 291-9287

Kansas City Area

11617 West 81st Street
 Lenexa, KS 66214
 T (913) 310-9963
 T (800) 796-0770
 F (913) 310-9976

Tampa Area

10351 Windhorst Road
 Tampa, FL 33619
 T (813) 621-6272
 T (877) 707-3966
 F (813) 621-7958

